

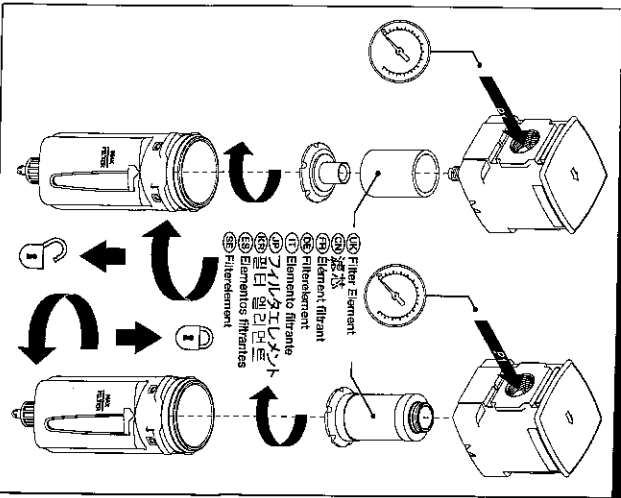

- FR Filter Element Replacement
- FR 替换滤芯
- FR Element filtrant de remplacement
- FR 滤芯替换
- FR Recambio del elemento filtrante
- FR Austausch des Filterelements
- FR Elemento filtrante di rimpiego



- FR Filter DPI
- FR 滤芯
- FR Filtro per filtro
- FR 过滤器
- FR Filtro DPI
- FR 过滤器
- FR Dp-indicator
- FR 过滤器指示器

- FR Lubricator
- FR 油雾器
- FR Lubrificatore
- FR 润滑器
- FR Dimensiorare
- FR 尺寸调整

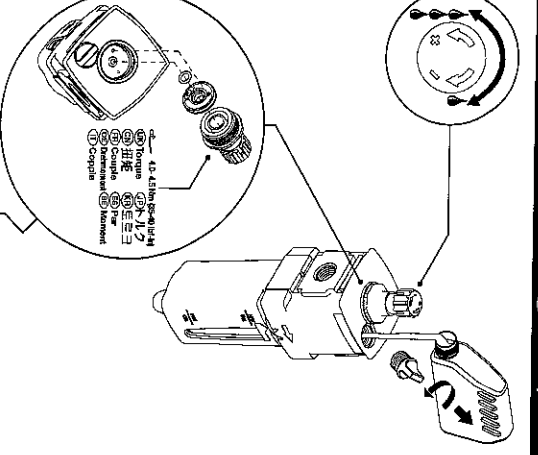

- FR Filter DPI
- FR 滤芯
- FR Filtro per filtro
- FR 过滤器
- FR Filtro DPI
- FR 过滤器
- FR Dp-indicator
- FR 过滤器指示器

- FR Body Connector
- FR 主体接头
- FR Connettore di corpo
- FR 连接器

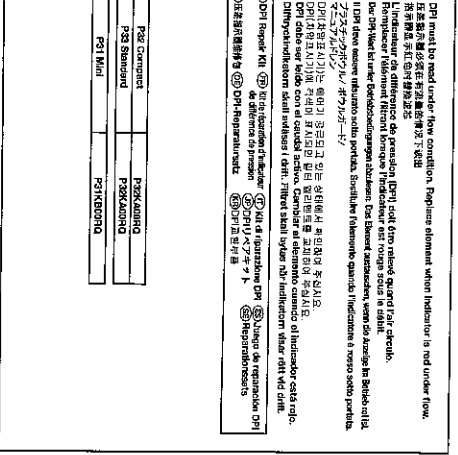

- FR Port Connector
- FR 接口接头
- FR Connettore per porta
- FR 接口连接器

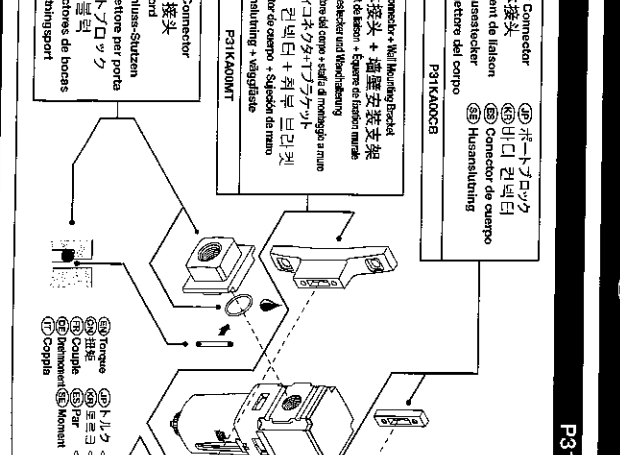

- FR Body Connector + Weld Mounting Bracket
- FR 主体接头 + 焊接安装支架
- FR Connettore di corpo + Supporto di fissaggio saldato
- FR 连接器 + 焊接固定支架

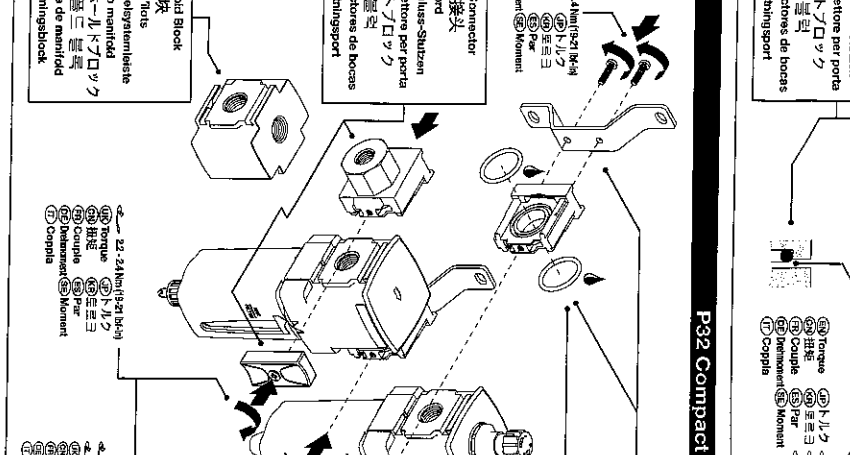

- FR Temporal Kit
- FR 防震减震件
- FR Kit anti-vibrante
- FR 防震减震器

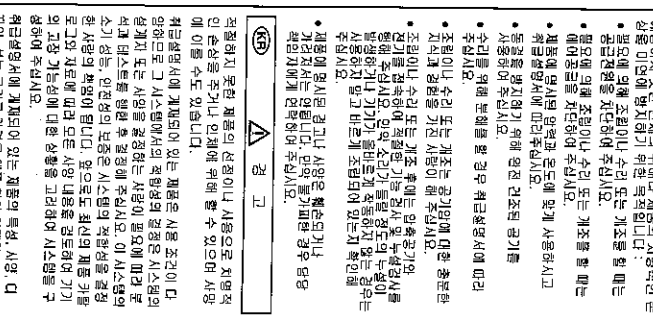

- FR P31 Mini
- FR P31K18DUAL
- FR P32 Compact
- FR P31K18DUAL
- FR P31K18DUAL
- FR P31K18DUAL

- FR P31 Mini
- FR P31K18DUAL
- FR P32 Compact
- FR P31K18DUAL
- FR P31K18DUAL
- FR P31K18DUAL

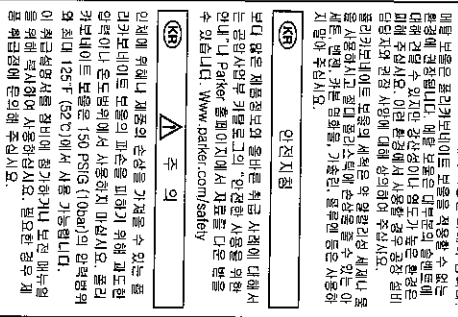

- FR P31 Mini
- FR P31K18DUAL
- FR P32 Compact
- FR P31K18DUAL
- FR P31K18DUAL
- FR P31K18DUAL

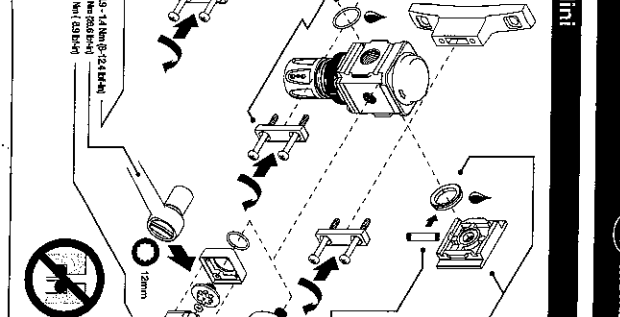

- FR P31 Mini
- FR P31K18DUAL
- FR P32 Compact
- FR P31K18DUAL
- FR P31K18DUAL
- FR P31K18DUAL

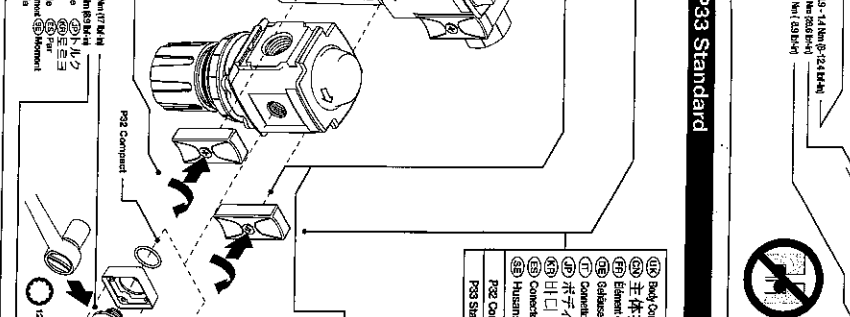

- FR P31 Mini
- FR P31K18DUAL
- FR P32 Compact
- FR P31K18DUAL
- FR P31K18DUAL
- FR P31K18DUAL

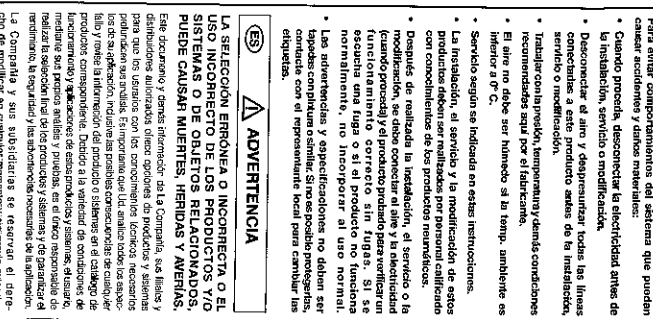

- FR P31 Mini
- FR P31K18DUAL
- FR P32 Compact
- FR P31K18DUAL
- FR P31K18DUAL
- FR P31K18DUAL

- FR P31 Mini
- FR P31K18DUAL
- FR P32 Compact
- FR P31K18DUAL
- FR P31K18DUAL
- FR P31K18DUAL

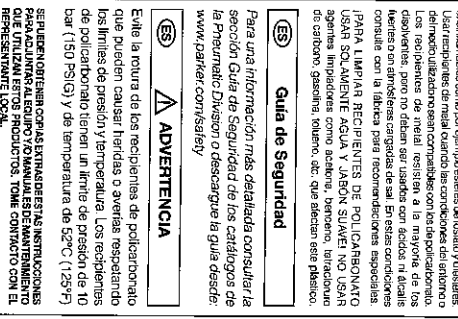

- FR P31 Mini
- FR P31K18DUAL
- FR P32 Compact
- FR P31K18DUAL
- FR P31K18DUAL
- FR P31K18DUAL

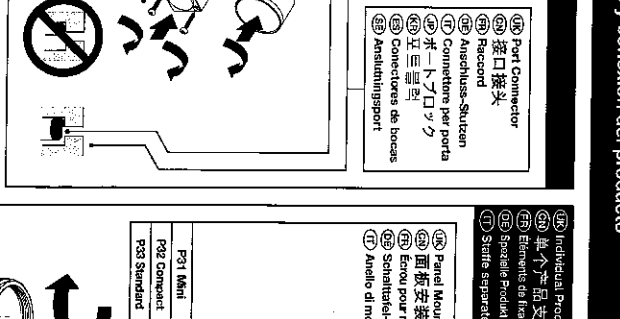

- FR P31 Mini
- FR P31K18DUAL
- FR P32 Compact
- FR P31K18DUAL
- FR P31K18DUAL
- FR P31K18DUAL

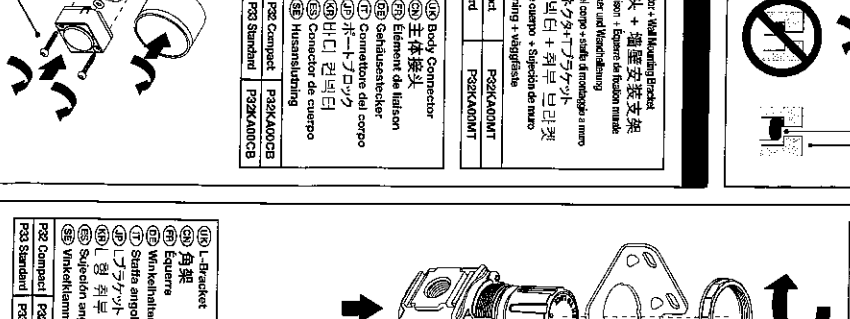

- FR P31 Mini
- FR P31K18DUAL
- FR P32 Compact
- FR P31K18DUAL
- FR P31K18DUAL
- FR P31K18DUAL

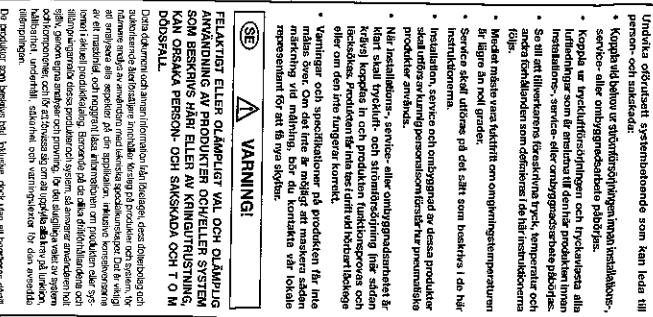

- FR P31 Mini
- FR P31K18DUAL
- FR P32 Compact
- FR P31K18DUAL
- FR P31K18DUAL
- FR P31K18DUAL

- FR P31 Mini
- FR P31K18DUAL
- FR P32 Compact
- FR P31K18DUAL
- FR P31K18DUAL
- FR P31K18DUAL

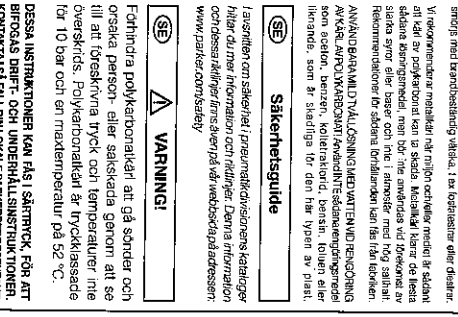

- FR P31 Mini
- FR P31K18DUAL
- FR P32 Compact
- FR P31K18DUAL
- FR P31K18DUAL
- FR P31K18DUAL



- FR P31 Mini
- FR P31K18DUAL
- FR P32 Compact
- FR P31K18DUAL
- FR P31K18DUAL
- FR P31K18DUAL

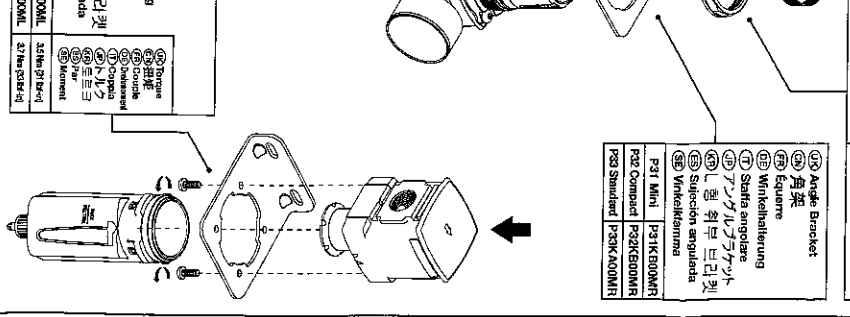

FR Product Connection + Mounting

FR Racordement + Montage du produit

FR Collegamento e montaggio del prodotto

FR Conexión y conexión del producto

FR Montering och inkoppling

- FR Individual Product Brackets
- FR 单个产品支架
- FR Elements de fixation pour produits individuels
- FR Spezial-Produktklammeren
- FR Staffe separate

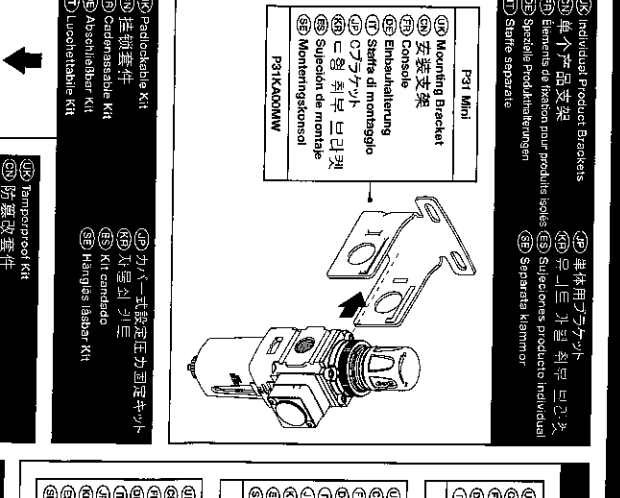

- FR Body Connector
- FR 主体接头
- FR Connettore di corpo
- FR 连接器

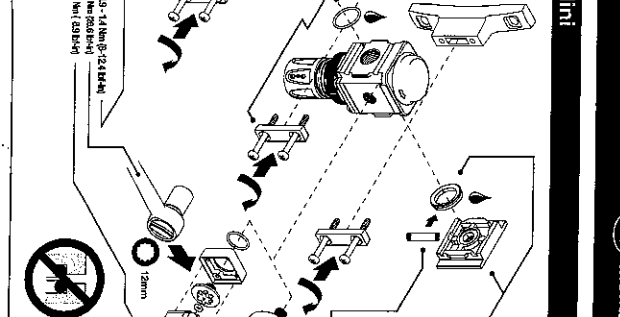

- FR Port Connector
- FR 接口接头
- FR Connettore per porta
- FR 接口连接器



- FR Body Connector + Weld Mounting Bracket
- FR 主体接头 + 焊接安装支架
- FR Connettore di corpo + Supporto di fissaggio saldato
- FR 连接器 + 焊接固定支架

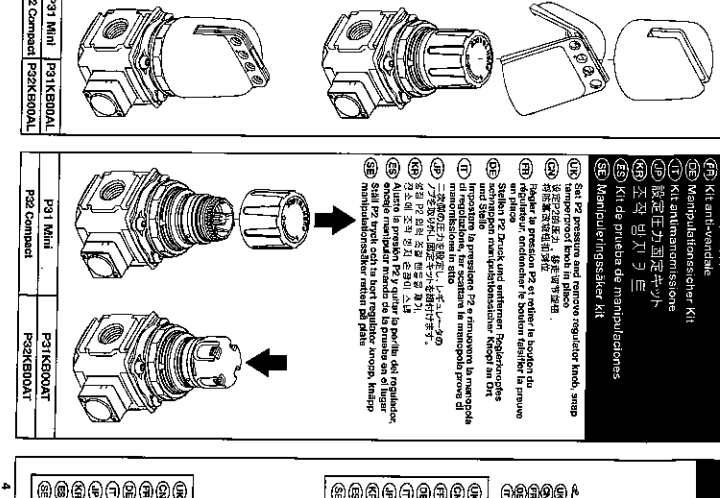

- FR Temporal Kit
- FR 防震减震件
- FR Kit anti-vibrante
- FR 防震减震器

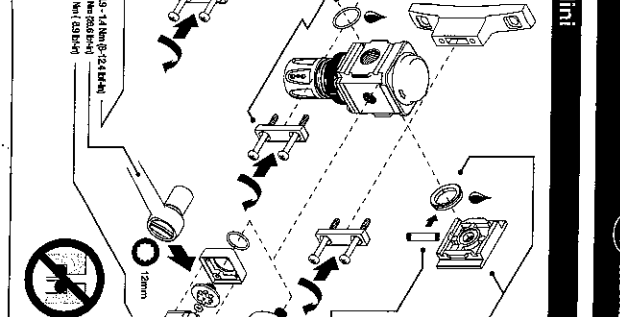

- FR P31 Mini
- FR P31K18DUAL
- FR P32 Compact
- FR P31K18DUAL
- FR P31K18DUAL
- FR P31K18DUAL

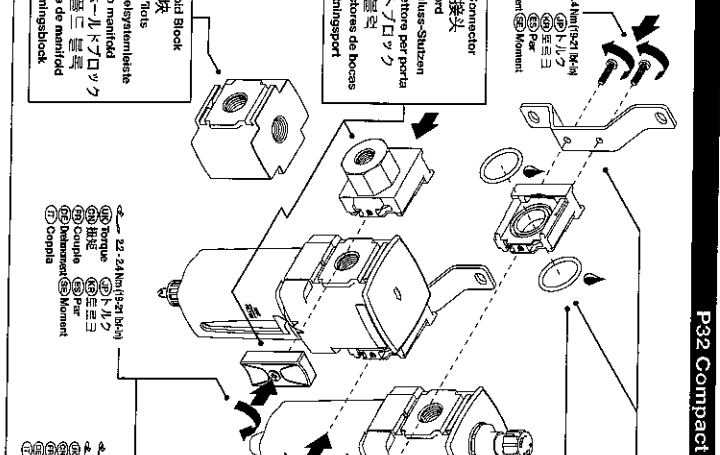

- FR P31 Mini
- FR P31K18DUAL
- FR P32 Compact
- FR P31K18DUAL
- FR P31K18DUAL
- FR P31K18DUAL

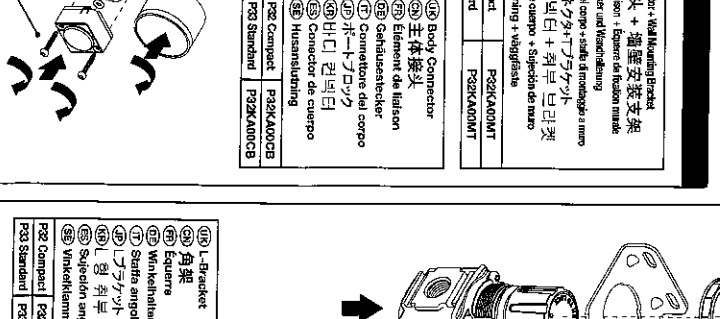

- FR P31 Mini
- FR P31K18DUAL
- FR P32 Compact
- FR P31K18DUAL
- FR P31K18DUAL
- FR P31K18DUAL

