

BLACKMER POWER PUMPS

961222
INSTRUCTIONS NO. 101-B00

INSTALLATION OPERATION AND MAINTENANCE INSTRUCTIONS

**MODELS: GX2B, GX2.5B, GX3E, GX4B,
X2B, X2.5B, X3E, X4B, XH2B, XH2.5B, XH3E, XH4B**

| | |
|----------------------------|-----------------------------|
| Section Effective Replaces | 101 Oct 2015 Jun 2015 |
|----------------------------|-----------------------------|

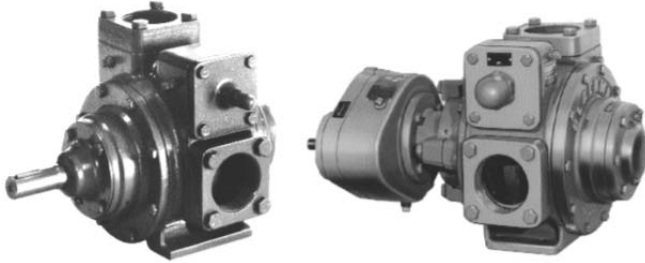

SAFETY DATA



This is a SAFETY ALERT SYMBOL.

When you see this symbol on the product, or in the manual, look for one of the following signal words and be alert to the potential for personal injury, death or major property damage



Warns of hazards that **WILL** cause serious personal injury, death or major property damage.



Warns of hazards that **CAN** cause serious personal injury, death or major property damage.



Warns of hazards that **CAN** cause personal injury or property damage.

NOTICE:

Indicates special instructions which are very important and must be followed.

NOTICE:

Blackmer Pumps **MUST** only be installed in systems, which have been designed by qualified engineering personnel. The system **MUST** conform to all applicable local and national regulations and safety standards.

This manual is intended to assist in the installation and operation of the Blackmer power pumps, and **MUST** be kept with the pump.

Pump service shall be performed by qualified technicians **ONLY**. Service shall conform to all applicable local and national regulations and safety standards.

Thoroughly review this manual, all instructions and hazard warnings, **BEFORE** performing any work on the pump.

Maintain **ALL** system and pump operation and hazard warning decals.

TABLE OF CONTENTS

Page

PUMP DATA

| | |
|---|---|
| Technical Data | 2 |
| Initial Pump Start Up Information | 2 |

INSTALLATION

| | |
|--|---|
| Pre-Installation Cleaning | 3 |
| Location and Piping | 3 |
| Mounting | 3 |
| Coupling Alignment | 4 |
| Gear Reducer Alignment – GX Models | 4 |
| Pump Rotation | 4 |
| To Change Pump Rotation | 4 |
| Check Valves | 4 |

OPERATION

| | |
|--|---|
| Pre-Start Up Check List | 5 |
| Start Up Procedures | 5 |
| Running the Pump in Reverse Rotation | 6 |
| Flushing the Pump | 6 |
| Pump Relief Valve | 6 |
| Relief Valve Setting and Adjustment | 6 |

PUMP MAINTENANCE

| | |
|-------------------------|---|
| Lubrication | 7 |
| Strainers | 7 |
| Vane Replacement | 8 |
| Pump Disassembly | 8 |
| Parts Replacement | 8 |
| Pump Assembly | 9 |

GEAR REDUCER MAINTENANCE

| | |
|--------------------------------|----|
| Gear Reducer Lubrication | 11 |
| Oil Seal Replacement | 12 |
| Gear Reducer Disassembly | 12 |
| Gear Reducer Assembly | 12 |

PUMP TROUBLE SHOOTING

GEAR REDUCER TROUBLE SHOOTING

NOTE: Numbers in parentheses following individual parts indicate reference numbers on Blackmer Parts Lists.

Blackmer pump manuals and parts lists may be obtained from Blackmer's website (www.blackmer.com) or by contacting Blackmer Customer Service.

| PUMP MODEL | PUMP PARTS LIST | | | |
|------------|-----------------|---------|---------|---------|
| | 2" | 2.5" | 3" | 4" |
| GX | 101-B01 | 101-B02 | 101-B03 | 101-B04 |
| X | 101-B05 | 101-B06 | 101-B07 | 101-B08 |
| XH | 101-B15 | 101-B16 | 101-B17 | 101-B18 |

SAFETY DATA

⚠ WARNING



Hazardous machinery can cause serious personal injury.

Failure to disconnect and lockout electrical power or engine drive before attempting maintenance can cause severe personal injury or death

⚠ WARNING



Hazardous or toxic fluids can cause serious injury.

If pumping hazardous or toxic fluids, system must be flushed and decontaminated, inside and out, prior to performing service or maintenance

⚠ WARNING



Do not operate without guard in place

Operation without guards in place can cause serious personal injury, major property damage, or death.

⚠ WARNING



Hazardous voltage. Can shock, burn or cause death.

Failure to disconnect and lockout electrical power before attempting maintenance can cause shock, burns or death

⚠ WARNING



Hazardous pressure can cause personal injury or property damage

Disconnecting fluid or pressure containment components during pump operation can cause serious personal injury, death or major property damage

⚠ WARNING



Hazardous pressure can cause personal injury or property damage

Failure to relieve system pressure prior to performing pump service or maintenance can cause personal injury or property damage.

PUMP DATA

PUMP IDENTIFICATION

A pump Identification tag, containing the pump serial number, I.D. number, and model designation, is attached to each pump. It is recommended that the data from this tag be recorded and filed for future reference. If replacement parts are needed, or if information pertaining to the pump is required, this data must be furnished to a Blackmer representative.

TECHNICAL DATA

| | 2", 2.5" | 3" | 4" |
|--|---------------------------|---------|---------|
| Maximum Pump Speed | 780 RPM | 640 RPM | 520 RPM |
| Maximum Viscosity | 20,000 SSU (4,250 cP) | | |
| Maximum Operating Temperature * | 240 – 300°F (115 – 149°C) | | |
| Maximum Differential Pressure | 125 psi (8.6 Bar) | | |
| Maximum Working Pressure | 175 psi (12.1 Bar) | | |

* Maximum operating limits are dependent on the materials of construction. See Blackmer Material Specs 101-095.

INITIAL PUMP START UP INFORMATION

| |
|---------------------------------------|
| Model No.: _____ |
| Serial No.: _____ |
| ID No.: _____ |
| Date of Installation: _____ |
| Inlet Gauge Reading: _____ |
| Discharge Gauge Reading: _____ |
| Flow Rate: _____ |

INSTALLATION

NOTICE:

Blackmer pumps must only be installed in systems designed by qualified engineering personnel. System design must conform with all applicable regulations and codes and provide warning of all system hazards.

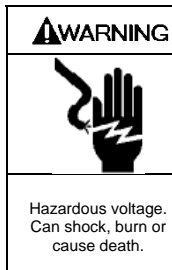

- ⚠ Install, ground and wire to local and National Electrical Code requirements.
- ⚠ Install an all-leg disconnect switch near the unit motor.
- ⚠ Disconnect and lockout electrical power before installation or service
- ⚠ Electrical supply **MUST** match motor nameplate specifications.

- ⚠ Motors equipped with thermal protection automatically disconnect motor electrical circuit when overload exists. Motor can start unexpectedly and without warning.

PRE-INSTALLATION CLEANING

NOTICE:

New pumps contain residual test fluid and rust inhibitor. If necessary, flush pump prior to use.

Foreign matter entering the pump WILL cause extensive damage. The supply tank and intake piping MUST be cleaned and flushed prior to pump installation and operation.

LOCATION AND PIPING

Pump life and performance can be significantly reduced when installed in an improperly designed system. Before starting the layout and installation of the piping system, review the following:

1. Locate the pump as near as possible to the source of supply to avoid excessive inlet pipe friction.
2. The inlet line **MUST** be at least as large as the intake port on the pump. The inlet piping should slope downward to the pump without any upward loops. Eliminate restrictions such as sharp bends; globe valves, unnecessary elbows, and undersized strainers.
3. It is recommended a strainer be installed in the inlet line to protect the pump from foreign matter. The strainer should be located at least 24" (0.6m) from the pump, and have a net open area of at least four times the area of the intake piping. For viscosities greater than 1000 SSU, consult the strainer manufacture instructions. Strainers must be cleaned regularly to avoid pump starvation.
4. The intake system must be free of air leaks.
5. Expansion joints, placed at least 36" (0.9m) from the pump, will compensate for expansion and contraction of the pipes. Contact the flexible connector/hose manufacturer for required maintenance/care and design assistance in their use.
6. Install pressure gauges in the NPT ports provided in the pump casing to check pump at start up.

7. ALL piping and fittings **MUST** be properly supported to prevent any piping loads from being placed on the pump.
8. Check alignment of pipes to pump to avoid strains which might later cause misalignment. See Figure 1. Unbolt flanges or break union joints. Pipes should not spring away or drop down. After pump has been in operation for a week or two, completely recheck alignment.

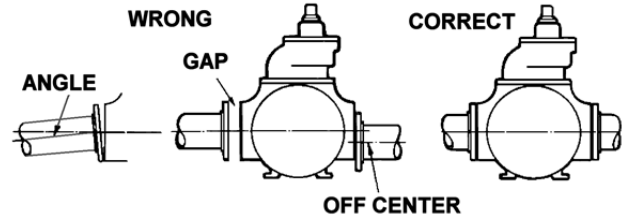

Figure 1

9. When pumping liquids at elevated temperature, provisions should be made to compensate for expansion and contraction of the pipes, especially when long pipe lines are necessary. Steel pipe expands approximately 3/4" (1.9 cm) per 100 feet (30.49 m) per 100°F (37.8°C) rise in temperature.

PUMP MOUNTING

A solid foundation reduces noise and vibration, and will improve pump performance. On permanent installations it is recommended the pumping unit be secured by anchor bolts as shown in Figure 2. This arrangement allows for slight shifting of position to accommodate alignment with the mounting holes in the base plate.

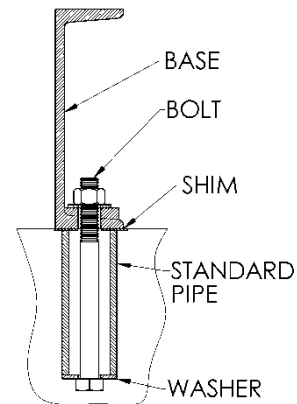

Figure 2 - Pipe Type Anchor Bolt Box

For new foundations, it is suggested that the anchor bolts be set in concrete. When pumps are to be located on existing concrete floors, holes should be drilled into the concrete to hold the anchor bolts.

When installing units built on channel or structural steel type bases, use care to avoid twisting the base out of shape when anchor bolts are tightened. Shims should be used under the edges of the base prior to tightening of the anchor bolts to prevent distortion.

COUPLING ALIGNMENT

The pump must be directly coupled to a gear and/or driver with a flexible coupling. Verify coupling alignment after installation of new or rebuilt pumps. Both angular and parallel coupling alignment **MUST** be maintained between the pump, gear, motor, etc. in accordance with manufacturer's instructions. See Figure 3.

1. Parallel alignment: The use of a laser alignment tool or dial indicator is preferred. If a laser alignment tool or dial indicator is not available, use a straightedge. Turn both shafts by hand, checking the reading through one complete revolution. Maximum offset should be less than .005" (.127 mm).
2. Angular alignment: Insert a feeler gauge between the coupling halves. Check the spacing at 90° increments around the coupling (four checkpoints). Maximum variation should not exceed .005" (.127 mm). Some laser alignment tools will check angular alignment as well.
3. Replace the coupling guards after setting alignment.

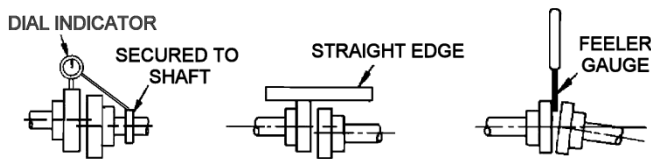
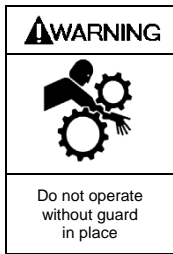

Figure 3 – Alignment Check



Operation without guards in place can cause serious personal injury, major property damage, or death.

GEAR REDUCER ALIGNMENT – GX MODELS

The reducer can be rotated on its mounting to raise or lower the input shaft to facilitate alignment to the motor shaft. To do so, first loosen the four clamp capscrews (20C) and the two setscrews (33) in the gear reducer spool flange. The reducer is then free to rotate. If necessary, tap it lightly with a soft faced mallet. When aligning the reducer, verify the alignment of the coupling halves as indicated in "Coupling Alignment" section.

NOTICE:

To determine maximum variation of gear reducer shaft alignment, refer to Blackmer GX model dimension pages

PUMP ROTATION

A right-hand pump rotates clockwise with the intake and relief valve on the right side, when viewed from the driven end.

A left-hand pump rotates counterclockwise with the intake and relief valve on the left side, when viewed from the driven end.

NOTICE:

On GX models, the gear reducer input shaft will rotate in the opposite direction of the pump shaft. For example, on a right-hand GX pump, the gear reducer shaft will rotate counterclockwise.

NOTICE:

Confirm correct pump rotation by checking the pump rotation arrows respective to pump driver rotation.

TO CHANGE PUMP ROTATION

To reverse rotation, the pump must be disassembled then reassembled with the shaft on the opposite side of the pump. See the 'Maintenance' section for instructions.

CHECK VALVES

The use of check valves or foot valves in the supply tank is not recommended with self-priming, positive displacement pumps.

If the possibility of liquid backflow exists when the pump is off, a check valve in the pump discharge piping is recommended because the pump can motor in the reverse rotation and create undue stress on all attached components. Never start a pump when it is rotating in the reverse rotation as the added starting torque can damage the pump and related equipment.

OPERATION

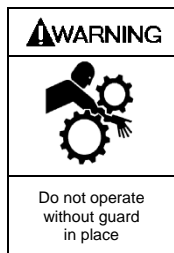

Operation without guards in place can cause serious personal injury, major property damage, or death.

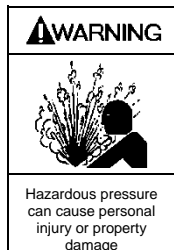

Disconnecting fluid or pressure containment components during pump operation can cause serious personal injury, death or major property damage

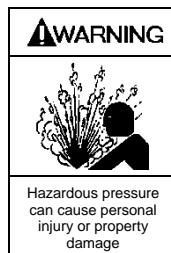

Failure to relieve system pressure prior to performing pump service or maintenance can cause personal injury or property damage.

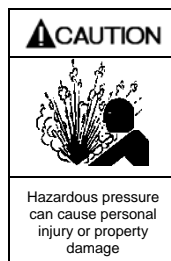

Pumps operating against a closed valve can cause system failure, personal injury and property damage

PRE-START UP CHECK LIST

1. Check the alignment of the pipes to the pump. Pipes should be supported so that they do not spring away or drop down when pump flanges or union joints are disconnected.
2. Verify proper coupling alignment.
3. On GX models, check the oil level in the gear reducer. Refer to 'Lubrication' in the 'Gear Reducer Maintenance' section of this manual.

NOTICE:

Blackmer gear reducers are not lubricated at the factory. Oil MUST be added before initial pump start-up

4. **On GX models shipped without the gear reducer attached, the inboard bearings are NOT greased at the factory. The inboard bearing MUST be greased after installation of the gear reducer and prior to initial pump start up.** See "Pump Lubrication" in the Maintenance section of this manual.
5. Check the entire pumping system to verify that the proper inlet and discharge valves are fully open, and that the drain valves and other auxiliary valves are closed.
6. Install vacuum and pressure gauges on the pump in the 1/4" NPT connections provided to check suction and discharge conditions after pump start-up.
7. Check the wiring of the motor, and briefly turn on the power to make sure that the pump rotates in the direction of the rotation arrow.

START UP PROCEDURES

NOTICE:

Consult the "General Pump Troubleshooting" section of this manual if difficulties during start up are experienced.

1. Start the motor. Priming should occur within one minute.
2. Check the suction and discharge pressure to see if the pump is operating within the expected conditions. Record pressures in the 'Initial Start Up Information' section.
3. Check for leakage from the piping and equipment.
4. Check for overheating, excessive noise or vibration of the pump, reducer, and motor.
5. Check the flow rate to ensure the pump is operating within the expected parameters. Record flow rate in the 'Initial Start Up Information' section.
6. Check the pressure setting of the relief valve by briefly closing a valve in the discharge line and reading the pressure gauge. This pressure should be 20 psi (1.4 bar) higher than the maximum operating pressure.

Do not run the pump for more than 15 seconds with the discharge valve completely closed.

If adjustments need to be made, refer to "Relief Valve Setting & Adjustment."

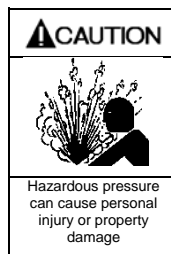

Incorrect settings of the pressure relief valve can cause pump component failure, personal injury, and property damage.

RUNNING THE PUMP IN REVERSE ROTATION

NOTICE:

Pump should be operated in reverse rotation for no more than 10 minutes and only when a separate pressure relief valve is installed to protect the pump from excessive pressure.

It may be desirable to run the pump in reverse rotation for system maintenance. The pump will operate satisfactorily in reverse rotation for a LIMITED time, at a reduced performance level.

FLUSHING THE PUMP

NOTICE:

If flushing fluid is to be left in the pump for an extended time, it must be a lubricating, non-corrosive fluid. If a corrosive or non-lubricating fluid is used, it must be flushed from the pump immediately.

1. To flush the pump, run the pump with the discharge valve open and the intake valve closed. Bleed air into the pump through the intake gauge plug hole or through a larger auxiliary fitting in the intake piping. Pump air for 30 second intervals to clean out most of the pumpage.
2. Run a system compatible flushing fluid through the pump for one minute to clear out the remainder of the original pumpage.
3. To remove the flushing fluid, follow step 1 above.

NOTICE:

After flushing the pump some residual fluid will remain in the pump and piping.

NOTICE:

Properly dispose of all waste fluids in accordance with the appropriate codes and regulations.

PUMP RELIEF VALVE

NOTICE:

The pump internal relief valve is designed to protect the pump from excessive pressure and must not be used as a system pressure control valve.

X,XH and GX series pumps are fitted with an internal pressure relief valve that bypasses back to the suction side of the pump.

Pumping volatile liquids under suction lift may cause cavitation. Partial closing of the discharge valve WILL result in internal relief valve chatter and is NOT recommended. For these applications, install an external system pressure control valve, and any necessary bypass piping, back to the storage tank.

A system pressure control valve is also recommended when operating for extended periods (more than 1 minute) against a closed discharge valve.

RELIEF VALVE SETTING AND ADJUSTMENT

The relief valve pressure setting is marked on a metal tag attached to the valve cover. Generally, the relief valve should be set at least 15 - 20 psi (1.0 - 1.4 Bar) higher than the operating pressure, or the external bypass valve setting (if equipped).

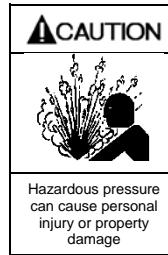

Incorrect settings of the pressure relief valve can cause pump component failure, personal injury, and property damage.

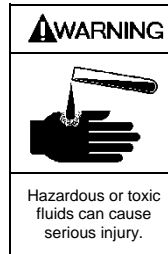

Relief valve cap is exposed to pumpage and will contain some fluid

DO NOT remove the R /V Cap OR adjust the relief valve pressure setting while the pump is in operation.

1. **To INCREASE the pressure setting**, remove the relief valve cap (1) and gasket (88). Loosen the locknut(3), if equipped. Turn the adjusting screw (2) *inward*, or clockwise. Inspect the R/V cap gasket (88) and replace as required. Reattach the R/V cap gasket and cap.
2. **To DECREASE the pressure setting**, remove the relief valve cap (1) and gasket (88). Loosen the locknut(3), if equipped. Turn the adjusting screw (2) *outward*, or counterclockwise. Inspect the R/V cap gasket (88) and replace as required. Reattach the R/V cap gasket and cap.

Refer to the individual Blackmer pump parts lists for various spring pressure ranges. Unless specified otherwise, pumps are supplied from the factory with the relief valve adjusted to the mid-point of the spring range.

MAINTENANCE:

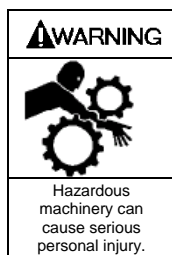

Failure to disconnect and lockout electrical power or engine drive before attempting maintenance can cause severe personal injury or death

Hazardous machinery can cause serious personal injury.

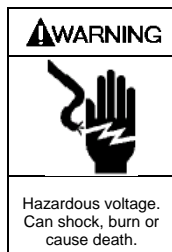

Failure to disconnect and lockout electrical power before attempting maintenance can cause shock, burns or death

Hazardous voltage. Can shock, burn or cause death.

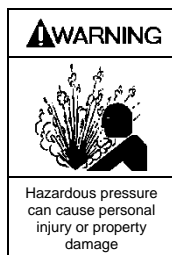

Failure to relieve system pressure prior to performing pump service or maintenance can cause personal injury or property damage.

Hazardous pressure can cause personal injury or property damage

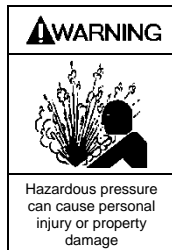

Disconnecting fluid or pressure containment components during pump operation can cause serious personal injury, death or major property damage

Hazardous pressure can cause personal injury or property damage

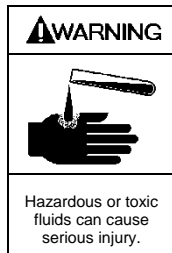

If pumping hazardous or toxic fluids, system must be flushed and decontaminated, inside and out, prior to performing service or maintenance

Hazardous or toxic fluids can cause serious injury.

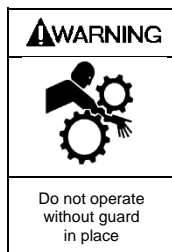

Operation without guards in place can cause serious personal injury, major property damage, or death.

Do not operate without guard in place

NOTICE:

Maintenance shall be performed by qualified technicians only. Follow the appropriate procedures and warnings as presented in this manual.

SCHEDULED MAINTENANCE

LUBRICATION

NOTICE:

To avoid possible entanglement in moving parts do not lubricate pump bearings, gear reducer or any other parts while the pump is running.

NOTICE:

The inboard bearings of GX models shipped without the gear reducer attached are NOT greased at the factory. The inboard bearing MUST be greased after installation of the gear reducer and prior to initial pump start up.

NOTICE:

If pumps are repainted in the field, ensure that the grease relief fittings (76A) are functioning properly after painting. Do NOT paint them closed. Remove any excess paint from the fittings.

Pump bearings should be lubricated every three months at minimum. More frequent lubrication may be required, depending on the application and operating conditions.

Recommended Grease:

Mobil® - Mobilgrease XHP222,
Exxon® - RONNEX MP Grease,
or equivalent Lithium grease..

Greasing Procedure:

1. Remove the grease relief fittings (76A) from the bearing covers (27, 27A).
2. **SLOWLY** apply grease with a hand gun until grease begins to escape from the grease relief fitting port. (76)
3. Replace the grease relief fittings (76A).

DO NOT overgrease pump bearings. While it is normal for some grease to escape from the grease tell-tale hole after lubrication, excessive grease on pumps equipped with mechanical seals can cause seal failure.

If equipped with a Blackmer gear reducer, refer to the 'Gear Reducer Lubrication' section of this manual.

STRAINERS

Strainers must be cleaned regularly to avoid pump starvation. Schedule will depend upon the application and conditions.

VANE REPLACEMENT

NOTICE:

Maintenance shall be performed by qualified technicians only. Follow the appropriate procedures and warnings as presented in manual.

1. Flush the pump per instructions in this manual. Drain and relieve pressure from the pump and system as required.
2. Remove the head assembly from the **outboard** (nondriven) side of the pump according to steps 5 - 8 in the "Pump Disassembly" section of this manual.
3. Turn the shaft by hand until a vane comes to the top (12 o'clock) position of the rotor. Remove the vane.
4. Install a new vane, ensuring that the rounded edge is UP, and the relief grooves are facing towards the direction of rotation. See Figure 4.
5. Repeat steps 3 and 4 until all vanes have been replaced.
6. Reassemble the pump according to the "Pump Assembly." section of this manual.

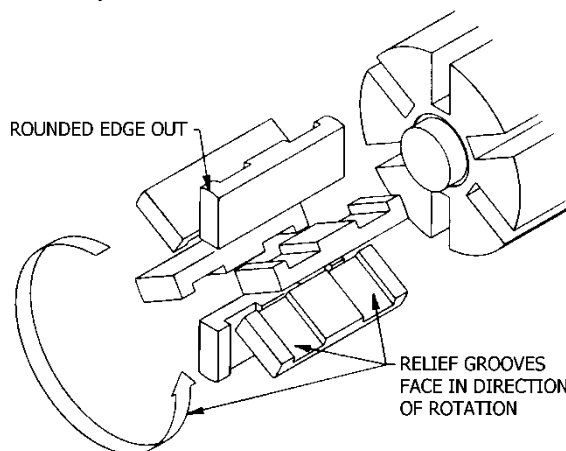

Figure 4 – Vane Replacement

PUMP DISASSEMBLY

NOTICE:

Follow all hazard warnings and instructions provided in the "Pump Maintenance" section of this manual.

1. Flush the pump per instructions in this manual. Drain and relieve pressure from the pump and system as required.
2. **On GX model pumps**, disengage the motor shaft coupling and remove the four clamp capscrews (20C) to release the clamps (20B). Loosen the two setscrews (33) in the gear reducer spool flange. The gear reducer can then be rotated away from the motor shaft and lifted off the pump. Refer to "Gear Reducer Maintenance" for reducer disassembly instructions.
3. Starting on the **inboard** (driven) end of the pump, clean the pump shaft thoroughly, making sure the shaft is free of nicks and burrs. This will prevent damage to the mechanical seal when the inboard head assembly is removed.
4. **On X/XH model pumps**, remove the inboard bearing cover capscrews (28) and slide the inboard bearing cover (27A) and gasket (26) off the shaft. Discard the gasket. On the X2 and X2.5-inch pump models, the dirt shield will come off with the bearing cover. Inspect dirt shield and replace as required.
5. Remove the outboard bearing cover capscrews (28) and the outboard bearing cover (27) and bearing cover gasket (26). Discard the bearing cover gasket.

6. **X2.5, XH2.5, X3 and XH3 pump models** are equipped with locknuts (24A) and lockwashers (24B). To remove:
 - a. Bend up the engaged lockwasher tang and rotate the locknut counterclockwise to remove it from the shaft.
 - b. Slide the lockwasher off the shaft. Inspect the lockwasher for damage and replace as required.
 - c. Repeat steps a and b on the opposite shaft end.
7. **X4/XH4 pump models** are equipped with bearing lock collars (24A). To remove:
 - a. Remove the jam nuts (24C) and loosen the two set screws (24B).
 - b. Slide the lock collar off the shaft.
 - c. Repeat steps a and b on the opposite shaft end.
8. Remove the head capscrews (21). Gently pry the head away from the cylinder.
9. Slide the head off the shaft. The head O-ring (72), bearing (24), and mechanical seal (153) will come off with the head assembly. Remove and discard the head O-ring.
 - a. Pull the bearing (24) from the housing in the head.
 - b. To remove the mechanical seal, use two screw drivers against the backside of the seal jacket to gently push the seal from the head (see Figure 5). Use care when placing the screw drivers to prevent damage to the seal faces. Remove and discard the seal O-rings.

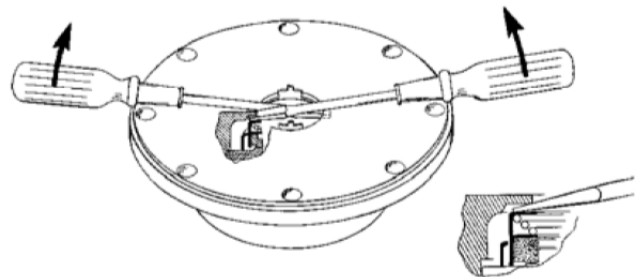

Figure 5 – Mechanical Seal Removal

10. Pull the rotor and shaft (13) from the cylinder. While one hand is pulling the shaft, the other hand should be cupped underneath the rotor to prevent the vanes (14) and push rods (77) from falling out. Carefully set the rotor and shaft aside for future vane replacement and reassembly.
11. Remove the remaining components from the outboard side of the pump, as instructed in steps 7 and 8 above.

PARTS REPLACEMENT

1. If any of the O-rings have been removed or disturbed during disassembly, they be replaced with new O-rings. **NOTE:** PTFE O-rings should be heated in hot water to aid installation.
2. Excessive or continuous leakage from the tell-tale hole in the bearing cover may be an indication of a damaged mechanical seal. If a mechanical seal has been leaking, it is recommended the entire seal be replaced. Refer to "General Pump Troubleshooting" for possible causes of seal leakage.

PUMP ASSEMBLY

Before reassembling the pump, inspect all component parts for wear or damage, and replace as required. Wash out the bearing/seal recess of the head and remove any burrs or nicks from the rotor and shaft.

1. **Reassemble the OUTBOARD side of the pump first:**
For a CLOCKWISE rotation pump, position the pump cylinder with the INTAKE port to the **left**.
For a COUNTERCLOCKWISE rotation pump, position the pump cylinder with the INTAKE port to the **right**.
2. Apply a small amount of quality O-ring lubricant in the head recess. With new O-rings installed, push the mechanical seal assembly (153) into the recess of the head with the seal jacket drive tangs inward. The pin in the seal stationary seat **MUST** be between the lugs in the back of the head recess.
3. Apply a small amount of O-ring lubricant to the O-ring groove on the inside face of the head to facilitate installation. Install a new head O-ring (72) in the groove by laying the O-ring flat and starting in on one side of the groove, stretching ahead with the fingers, as shown in Figure 8.

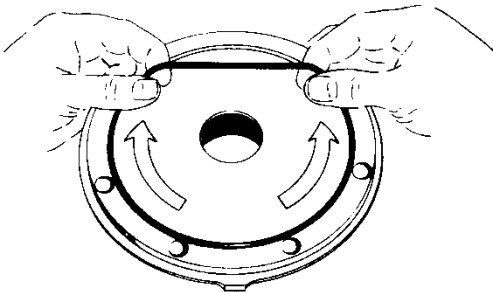

Figure 8 – Head O-Ring Installation

4. Install the head (20) on the outboard side of the cylinder. Install and snug up four head capscrews (21) 90° apart.
5. Hand pack the ball bearing (24) with grease. Refer to "Lubrication" in the Pump Maintenance Section for the recommended grease.
6. Install the bearing into the head recess. The bearing balls should face outward, with the grease shield inward. Ensure the bearing is fully and squarely seated against the mechanical seal.
7. Turn the pump cylinder around and begin assembly on the opposite, inboard end.
8. Remove the vanes (14) and push rods (77) from the rotor and shaft assembly. Inspect for wear and damage, and replace as follows:
 - a. Partially install the non-driven end of the rotor and shaft (13) into the open side of the pump cylinder.
 - b. Leave part of the rotor outside of the cylinder so that the bottom vanes can be installed and held in place as the push rods are installed in the push rod holes of the rotor. Insert the new vanes into the rotor slots with the rounded edges outward, and the vane relief grooves facing TOWARDS the direction of rotation. Refer to Figure 4 in "Vane Replacement."
 - c. After the bottom vanes and push rods are installed, insert the rotor and shaft fully into the cylinder.
 - d. Install the remaining vanes into the top positions of the rotor. **Rotate the shaft by hand to engage the drive tangs of the mechanical seal jacket in the rotor slots.**
9. Apply a thin coating of quality O-ring lubricant on the inboard shaft to aid installation. Install the inboard head, mechanical seal, and bearing as instructed in steps 2 through 6.
10. Rotate the shaft by hand to engage the seal drive tangs, and to test for binding or tight spots. If the rotor does not turn freely, lightly tap the rims of the heads with a soft faced mallet until the correct position is found. Install all of the remaining head capscrews for each head and uniformly tighten, then torque to 25 lbs ft (34 Nm).

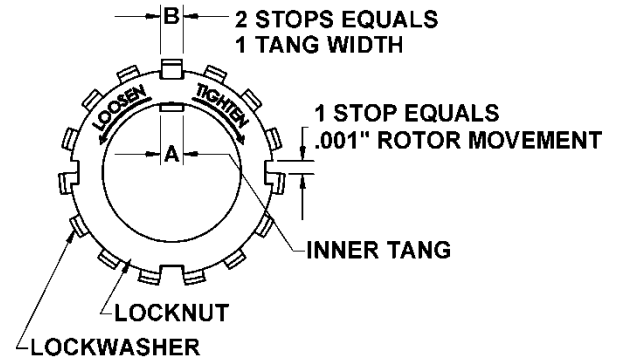

Figure 9 – Locknut Assembly

11. LOCKNUT ADJUSTMENT –

X2.5, XH2.5, X3, XH3 Models Only

It is important that the bearing locknuts (24A) and lockwashers (24B) be installed and adjusted properly. Overtightening locknuts can cause bearing failure or a broken lockwasher tang. Loose locknuts will allow the rotor to shift against the discs, causing wear. See Figure 9.

- a. On both ends of the pump shaft, install a lockwasher (24B) with the tangs facing outward, followed by a locknut (24A) with the tapered end inward. Ensure the inner tang "A" of the lockwasher is located in the slot in the shaft threads, bending it slightly, if necessary.
- b. Tighten both locknuts to ensure that the bearings are bottomed in the head recess. **DO NOT overtighten and bend or shear the lockwasher inner tang.**
- c. Loosen both locknuts one complete turn.
- d. Tighten one locknut until a slight rotor drag is felt when turning the shaft by hand.
- e. Back off the nut the width of one lockwasher tang "B". Secure the nut by bending the closest aligned lockwasher tang into the slot in the locknut. The pump should turn freely when rotated by hand.
- f. Tighten the opposite locknut by hand until it is snug against the bearing. Then, using a spanner wrench, tighten the nut the width of one lockwasher tang "B". Tighten just past the desired tang, then back off the nut to align the tang with the locknut slot. Secure the nut by bending the aligned lockwasher tang into the slot in the locknut. The pump should continue to turn freely when rotated by hand.
- g. To check adjustment, grasp the nut and washer with fingers and rotate back and forth. If this cannot be done, one or both locknuts are too tight and should be alternately loosened one stop at a time 0.001" (0.025mm). Begin by loosening the locknut adjusted last.

12. LOCK COLLAR INSTALLATION – X4, XH4 Models

- a. Slide the lock collar (24A) over the shaft and against the bearing (24), with the counterbored side towards the bearing
- b. Push the collar (24A) forcibly against the bearing (24) by hand, while tightening the two setscrews (24B). Install and tighten the two jam nuts (24C) against the collar
- c. Repeat this procedure on the opposite pump end. After installing both lock collars, verify the shaft turns freely when rotated by hand

13. **On X/XH model pumps**, inspect the grease seal for wear or damage and replace as required. Grease the outside diameter of the grease seal (104) and push it into the inboard bearing cover (27A) with the lip inward. The lip will face outward when the bearing cover is installed on the head. Attach a new bearing cover gasket (26) and the bearing cover (27A) to the inboard head. Install and torque the bearing cover capscrews (28) to 15 lbs ft (20 Nm).

14. Attach a new bearing cover gasket (26) and the outboard bearing cover (27) to the outboard head. Install and torque the bearing cover capscrews (28) to 15 lbs ft (20 Nm).

15. **On X2, XH2, X2.5 and XH2.5 models**, push the dirt shield (123A) over the inboard shaft and firmly against the bearing cover.

16. RELIEF VALVE ASSEMBLY

- a. Insert the valve (9) into the relief valve bore of the casing with the fluted end inward.
- b. Install the relief valve spring (8) and spring guide (7) against the valve.
- c. Attach a new relief valve O-ring (10) and the valve cover (4) on the cylinder.
- d. Screw the relief valve adjusting screw (2) with locknut (3) into the valve cover (4) until it makes contact with the spring guide (7).
- e. After the relief valve has been adjusted, tighten the Locknut (3) and install the relief valve cap (1) and O-ring (88)

NOTICE:

The relief valve setting **MUST** be tested and adjusted more precisely before putting the pump into service. Refer to "Relief Valve Setting and Adjustment"

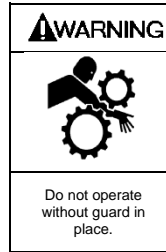

Operation without guards in place can cause serious personal injury, major property damage, or death.

17. Reinstall coupling, shaft key, and coupling guards.
18. Refer to "Pre-Start Up Check List" and "Start Up Procedures" sections of this manual prior to restarting pump operation.

GEAR REDUCER MAINTENANCE – GX MODELS

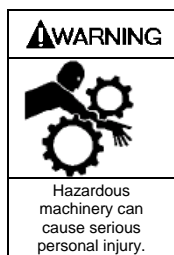

Failure to disconnect and lockout electrical power or engine drive before attempting maintenance can cause severe personal injury or death

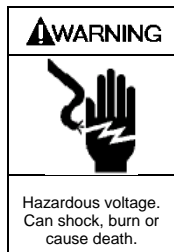

Failure to disconnect and lockout electrical power before attempting maintenance can cause shock, burns or death

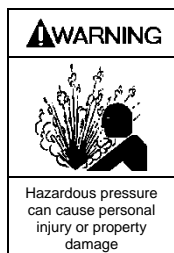

Failure to relieve system pressure prior to performing pump service or maintenance can cause personal injury or property damage.

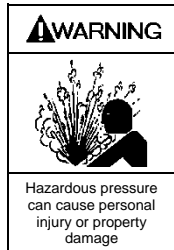

Disconnecting fluid or pressure containment components during pump operation can cause serious personal injury, death or major property damage

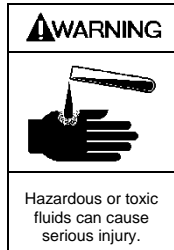

If pumping hazardous or toxic fluids, system must be flushed and decontaminated, inside and out, prior to performing service or maintenance

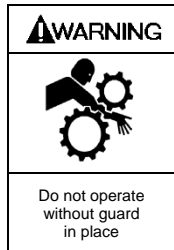

Operation without guards in place can cause serious personal injury, major property damage, or death.



Failure to allow gear reducer to cool before attempting maintenance can cause serious personal injury.

NOTICE:

Maintenance shall be performed by qualified technicians only. Following the appropriate procedures and warnings as presented in this manual.

NOTICE:

Full load operating temperature of the gear reducer can reach 180°F (82°C).

GEAR REDUCER LUBRICATION

NOTICE:

To avoid possible entanglement in moving parts do not lubricate pump bearings, gear reducer or any other parts while the pump is running.

NOTICE:

Blackmer gear reducers are not lubricated at the factory. Oil **MUST** be added before initial pump start up.

Horsepower calculations for Blackmer reducers are based on 75°F (24°C) ambient air temperature; 200°F (93°C) maximum oil temperature using synthetic oil.

Oil Change Schedule: For normal operation, the gear reducer oil should be changed every 6 months or 1000 hours, whichever is shorter. If operating in conditions with wide ranges in temperature, or in an unusually moist or dusty atmosphere, the oil should be changed every 3 months or 500 hours, whichever is shorter.

Recommended Oil: Use a synthetic oil with oxidation inhibitors that is compatible with Buna elastomers. Use synthetic oil AGMA Viscosity Grade 4 or ISO Viscosity Grade 150 such as Mobil SHC 629, Mobil SHC 630, Shell Omala S4 GX 150, Castrol Isolube EP 150 or equivalent.

To add oil to the gear reducer:

1. Remove the oil level plug (29) and the fill & vent plug (76C).
2. Add oil through the fill hole until oil runs out of the oil level plug hole.

| Pump Model | Reducer Model | Approx. Oil Capacity * |
|------------|---------------|------------------------|
| GX2, GX2.5 | HRO-GX | 0.5 qt. (0.47 l) |
| GX3 | HRA-GX | 0.75 qt. (0.71 l) |
| GX4 | HRB-GX | 1.25 qt. (1.18 l) |

* Capacity will vary depending on the orientation of the reducer mounting.

3. Replace the oil level plug and fill & vent plug. Make sure the vent fitting in the fill plug is kept clean to prevent expansion from forcing oil leaks at the shaft.

NOTICE:

To maintain proper gear reducer lubrication, the vent plug must be positioned higher than the oil level plug. To determine maximum variation of gear reducer shaft alignment, refer to Blackmer GX model dimension pages.

OIL SEAL REPLACEMENT

NOTICE:

Follow all hazard warnings and instructions provided in the "Pump Maintenance" and "Gear Reducer Maintenance" sections of this manual.

To replace the oil seal on the INPUT SHAFT (102):

1. Drain and properly dispose of oil from gear reducer by removing the oil level plug (29) and drain plugs (29A).
2. Remove the closure plate capscrews (116), the closure plate (114), and the closure plate gasket (115) from the gearcase. Press the oil seal (104 or 104A) from the closure plate. Discard the gasket and oil seal.
3. Grease the outer edge of a new oil seal and press the flat side of the seal into the inside face of the closure plate. When the closure plate is reattached to the gearcase cover, the lips of the oil seal should face the inside of the gearcase.
4. Place the closure plate and a new gasket on the gearcase cover. Install and torque the closure plate capscrews (116) as indicated in Table 2.

To replace the oil seal on the OUTPUT SHAFT (125A):

1. Follow steps 1 - 5 of the "Gear Reducer Disassembly."
2. Remove the output shaft (125A) and gear assembly, and press the oil seal (104 or 104A) from the inside bore of the gearcase. Discard oil seal. Inspect gear reducer bearings for wear or damage and replace as required following steps 2 and 3 of the "Gear Reducer Assembly" section of this manual.
3. Grease the outer edge of a new oil seal and firmly press the flat side of the seal into the bore of the gearcase. The lips of the seal should face the inside of the gearcase.
4. Reinstall the output shaft and gear assembly, the new closure plate gasket and the closure plate. Install and torque the closure plate capscrews (116) as indicated in Table 2.
5. Refill the gear reducer with oil following the procedures provided in the "Gear Reducer Lubrication" section of this manual.

GEAR REDUCER DISASSEMBLY

NOTICE:

Follow all hazard warnings and instructions provided in the "Pump Maintenance" and "Gear Reducer Maintenance" sections of this manual.

1. If the reducer has not been removed from the pump, disengage the motor shaft coupling and remove the four clamp capscrews (20C) to release the clamps (20B). Loosen the two setscrews (33) in the gear reducer spool flange. The gear reducer can then be rotated away from the motor shaft and lifted off the pump
2. Drain and properly dispose of oil from gear reducer by removing the oil level plug (29) and oil drain plugs (29A).
3. Remove the gear case cover capscrews (112). Insert a wedge between the projecting lugs on the cover and tap lightly until the cover is loosened and can be removed. The gear case cover is positioned with two (2) dowel pins (38), which remain in the gearcase.
4. Remove the cover gasket (111) and discard.

5. The pinion and input shaft (102) is a one-piece assembly and does not come apart. If required, remove the bearings (24, 24A) from the shaft with a bearing puller or arbor press.
6. To remove the gear (101) and bearings from the splined output shaft (125A), support the assembly on the gear and press the shaft out of the gear and bearings.
7. Refer to "Oil Seal Replacement" to remove and install new oil seals.

GEAR REDUCER ASSEMBLY

Before reassembling the gear reducer, inspect all component parts for wear or damage, and replace as required. Wash out the bearing bores and remove any burrs or sharp edges with a file.

1. If the shaft and bearing assemblies have not been disassembled, begin assembly at step 4.
2. The output shaft (125A) is reduced in diameter at one end of the gear area to facilitate gear and bearing installation.
 - a. Before installing the gear and bearings, remove all dirt, burrs or sharp edges from the shaft to prevent galling or seizing. Apply a light coating of graphite, moly sulphide or white grease to the shaft.
 - b. Using an arbor press, press the shaft squarely into the bearing (24, 24A or 24C). Install the spacer ring (82 or 82B)
 - c. Align the gear key (124) with the notch in the gear, and press the gear (101) squarely onto the shaft. Install the spacer ring (82 or 82A).
 - d. Press the second bearing (24, 24A or 24B) onto the shaft. On HRA-GX and HRO-GX models, install the retaining ring (83A).
3. Prior to installing the bearings on the input shaft, remove all dirt, burrs or sharp edges from the shaft to prevent galling or seizing. Apply a light coating of graphite, moly sulphide or white grease to the shaft.
 - a. For HRA-GX gear ratios 5.06, 6.27 and 7.65 install the retaining ring (83B) on the non-driven (shorter end) of the input shaft.
 - b. Using an arbor press, press a bearing (24 or 24A) onto each end of the shaft.
4. Grease the outer edge of a new oil seal (104 or 104A) and firmly press the flat side of the seal into the bore of the gearcase. The lips of the seal should face the inside of the gearcase.
5. Apply a light coat of oil in the bearing bores of the gearcase to ease bearing and shaft assembly installation.
6. With the gearcase resting flat on the spool flange (cavity side up), start the output shaft (125A) into the bearing bore. Align the bearings and gear teeth of the input shaft (102) with the output shaft, and ensure that the bearings are lined up squarely with the bores. Drop the two shaft assemblies together into their respective bearing bores.
7. Rotate the shafts by hand to verify free movement and proper bearing position.
8. Set the new cover gasket (111) on the gearcase.
9. Install the cover (110) on the gearcase, using the dowel pins for proper positioning. Install the cover capscrews (112), torquing to 30 lbs ft (40.6 Nm).
10. On HRA-GX reducer models, install the spacer rings (82C & 82D) into the gearbox cover assembly (110).

11. Grease the outer edge of a new oil seal (104 or 104A) and press the flat side of the seal into the inside face of the closure plate (114).
12. Place the closure plate (114) and a new gasket (115) on the gearbox assembly cover. Install and torque the closure plate capscrews (116) as indicated in Table 2.
13. On HRB-GX reducer models, attach the blind closure plate gasket (119A) and closure plate (119) to the cover. Install and torque the closure plate capscrews (116) as indicated in Table 2.

14. On HRO-GX reducer models, install the remaining two cover capscrews (112A); torque to 30 lbs ft (40.6 Nm)
15. Refill the gear reducer with oil following the procedures provided in the "Gear Reducer Lubrication" section.

| Ref No. | Pump Model | Reducer Model | Torque lbs ft (Nm) |
|---------|------------|---------------|--------------------|
| 116 | GX2, GX2.5 | HRO-GX | 30 (40.6) |
| | GX3 | HRA-GX | 5 (6.8) |
| | GX4 | HRB-GX | 10 (13.6) |

Table 2

PUMP TROUBLESHOOTING

NOTICE:

Maintenance shall be performed by qualified technicians only, following the appropriate procedures and warnings as presented in this manual.

| Symptom | Probable Cause |
|-------------------------|---|
| Pump Not Priming | <ol style="list-style-type: none"> 1. Pump not wetted. 2. Worn vanes 3. Suction valve closed. 4. Air leaks in the suction line. 5. Strainer clogged. 6. Suction line or valves clogged or too restrictive. 7. Pump vapor-locked. 8. Pump speed too low for priming. 9. Relief valve partially open, worn or not seating properly. |
| Reduced Capacity | <ol style="list-style-type: none"> 1. Pump speed too low. 2. Suction valves not fully open. 3. Air leaks in the suction line. 4. Excessive restriction in the suction line (undersized piping, too many elbows & fittings, clogged strainer, etc.). 5. Damaged or worn parts. 6. Excessive restriction in discharge line causing partial flow through the relief valve. 7. Relief Valve worn, set too low, or not seating properly. 8. Vanes installed incorrectly (see "Vane Replacement"). |
| Noise | <ol style="list-style-type: none"> 1. Excessive vacuum on the pump due to: <ol style="list-style-type: none"> a. Undersized or restricted fittings in the suction line. b. Pump speed too fast for the viscosity or volatility of the liquid. c. Pump too far from fluid source. 2. Running the pump for extended periods with a closed discharge line. 3. Pump not securely mounted. 4. Bearings worn or damaged. 5. Vibration from improperly anchored piping. 6. Bent shaft, or drive coupling misaligned. 7. Excessively worn rotor. 8. Malfunctioning valve in the system. 9. Relief valve setting too low. 10. Damaged vanes (see following category). 11. Vanes installed incorrectly (see "Vane Replacement"). |
| Damaged Vanes | <ol style="list-style-type: none"> 1. Foreign objects entering the pump. 2. Running the pump dry for extended periods of time. 3. Cavitation. 4. Viscosity too high for the vanes and/or the pump speed. 5. Incompatibility with the liquids pumped. 6. Excessive heat. 7. Worn or bent push rods, or worn push rod holes. 8. Settled or solidified material in the pump at start-up. 9. Hydraulic hammer - pressure spikes. 10. Vanes installed incorrectly (see "Vane Replacement"). |

PUMP TROUBLESHOOTING

| | |
|--------------------------------|--|
| Broken Shaft | <ol style="list-style-type: none"> 1. Foreign objects entering the pump. 2. Viscosity too high for the pump speed - EC Rotor & Shaft required for fluid viscosities over 20,000 SSU. 3. Relief valve not opening. 4. Hydraulic hammer - pressure spikes. 5. Pump/driver misalignment. 6. Excessively worn vanes or vane slots. 7. Settled or solidified material in the pump at start-up. |
| Mechanical Seal Leakage | <ol style="list-style-type: none"> 1. O-rings not compatible with the liquids pumped. 2. O-rings nicked, cut or twisted 3. Shaft at seal area damaged, worn or dirty. 4. Ball bearings overgreased. 5. Excessive cavitation. 6. Mechanical seal faces cracked, scratched, pitted or dirty. |

GEAR REDUCER TROUBLESHOOTING

NOTICE:

Maintenance shall be performed by qualified technicians only, following the appropriate procedures and warnings as presented in this manual.

| Symptom | Probable Cause |
|----------------------------|--|
| Noise and Vibration | <ol style="list-style-type: none"> 1. Worn or damaged bearings. Replace as required. 2. Inadequate lubrication or incorrect lubricant (see "Gear Reducer Lubrication"). 3. Impurities in the lubricant, such as abrasive particles. 4. Excessive overloading. Check horsepower requirements. 5. Worn or damaged gear teeth. 6. Misalignment of pump or motor. Refer to "Gear Reducer Alignment" section of this manual, and Blackmer GX model Dimensions 101-105 – 101-108 for maximum variation of shaft alignment. |

NOTES

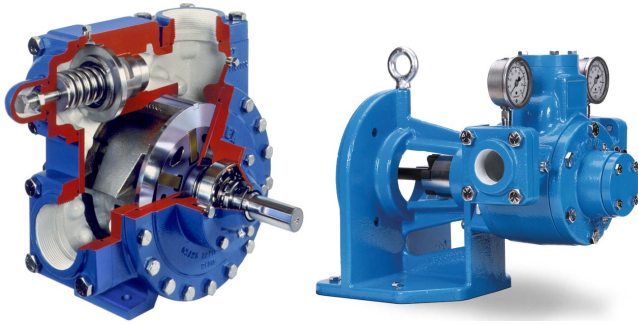

Sliding Vane Pumps: 5 to 2200 GPM
 Refined Fuels, Liquefied Gases, Solvents, Process



Stainless Steel Sliding Vane Pumps
 1 to 265 GPM: Acids, Brines, Sugars, Syrups,
 Beer, Beet Juice, Cider, Flavor Extracts, etc.



System One® Centrifugal Pumps
 10 to 7500 GPM; Process, Marine

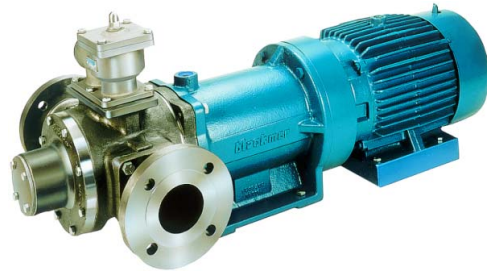

Magnetic Drive Pumps
 Stainless Steel: 14 to 215 GPM

HXL 6, 8 & 10"
 Sliding Vane Pumps
 130 to 2,220 GPM

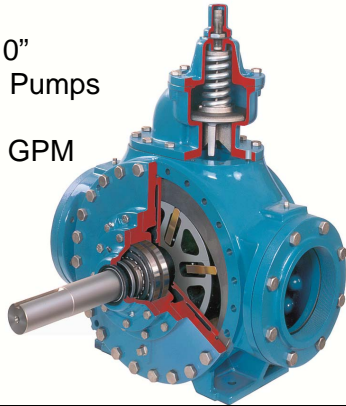

Refineries
 Terminals
 Barges
 Ships



Reciprocating Gas Compressors
 Liquefied Gas Transfer, Boosting, Vapor Recovery



Hand Operated Pumps
 Dispensing, Transfer, In-line



Accessories
 Gear Reducers, Bypass Valves, Strainers

Visit www.blackmer.com for complete information on all Blackmer products



1809 Century Avenue, Grand Rapids, Michigan 49503-1530 U.S.A.
 Telephone: (616) 241-1611 • Fax: (616) 241-3752

E-mail: blackmer@blackmer.com • Internet Address: www.blackmer.com