

EAGO

EAGO Sanitary Ware Co.,Ltd.

Factory Add:Shiling Development Zone,Xiaotang Town,Nanhai District,Foshan City,Guangdong,China

National Service Hotline 800-8301359

EAGO

DZ963F8/DZ964F8/DZ965F8 Installation Instruction

Important safe information

1. Please read this instruction and assemble the steam shower according to it.
2. The leakage protection switch must be installed. Besides, please try it to check whether it is safe enough before formal using.
3. The ground line of the product must be connected to the earth permanently.
4. To Avoid being shocked by the electricity, please prepare enough plugs and fixed them near to the product, please change those old or disrepair wires in time.
5. It is strictly forbidden to use the steam shower after drink or eat some hypnotic medicine.
6. Children should be guided by parents while using.
7. Especially note: The using water temperature should not pass 60 centigrade or 140 Fahrenheit.
8. Do not use any strong chemical liquid such as Vitriol, Hydrochloric acid, Lye and so on to clean the steam shower.
9. There is a connecting screw in the Wire Connecting Box, to avoid being shocked by the electrical, please be sure to connect this screw to the ground wire which is fixed on the power board. It is better to use the same size insulated wire, and the size not less than 1.5 square millimetre cooper-core wire.
10. Warning: To avoid being shocked by the electricity, please be sure to connect the DFCI/RCD to the ground plug.
11. If the steam shower with 3KW/4.5KW/6KW steam generator, the specification of the wires used not less than 2.5square millimeter/ 4square millimeter/ 6square millimeter.
12. It is not allowed to use any moisture enhancing machine in the steam shower.

Installation wiring diagram

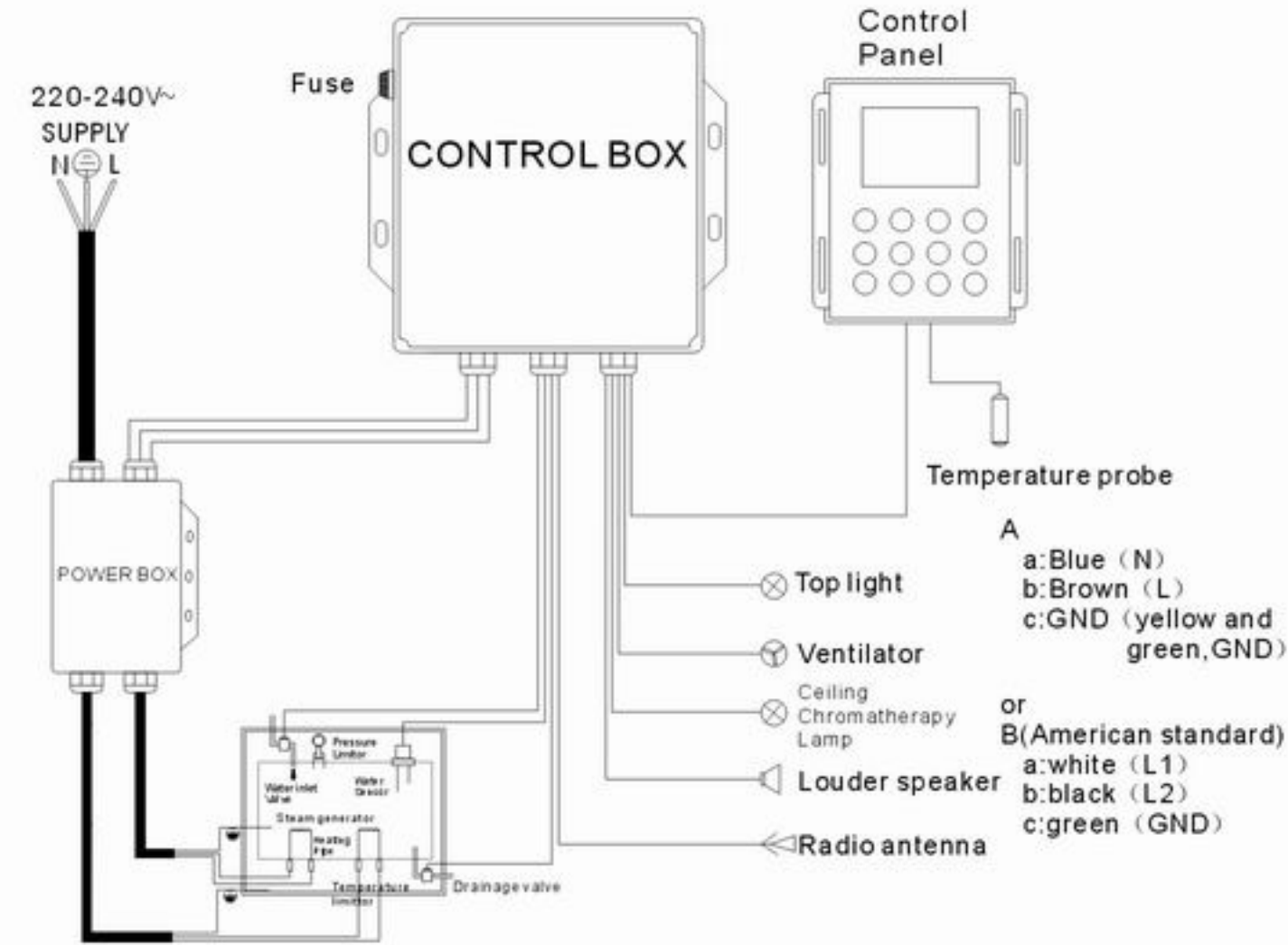

Electrical parts specification

Configuration Parameter	massage pump	steam generator	ceiling light	exhausting fan	Solenoid valves	CPU	Speaker	Note
Rating voltage		AC220-240V/50HZ	DC12V	DC12V	DC12V	AC220V-240V/ 50HZ		
Rating voltage		AC240V/60HZ	DC12V	DC12V	DC12V	AC240V/60HZ		
Rating power		3000W	10W	3W	5W		10W	
Rating power		4500W	10W	3W	5W		10W	
Rating power		6000W	10W	3W	5W		10W	

CONTENTS

- 01-02 Component Directions
- 03 Technical Drawing
- 04-10 Installation steps
- 11-12 Control panel keys and function directions
- 13 Illustration for cleaning function
- 14 Maintenance service card
- 16 Troubles shooting

Parts instruction

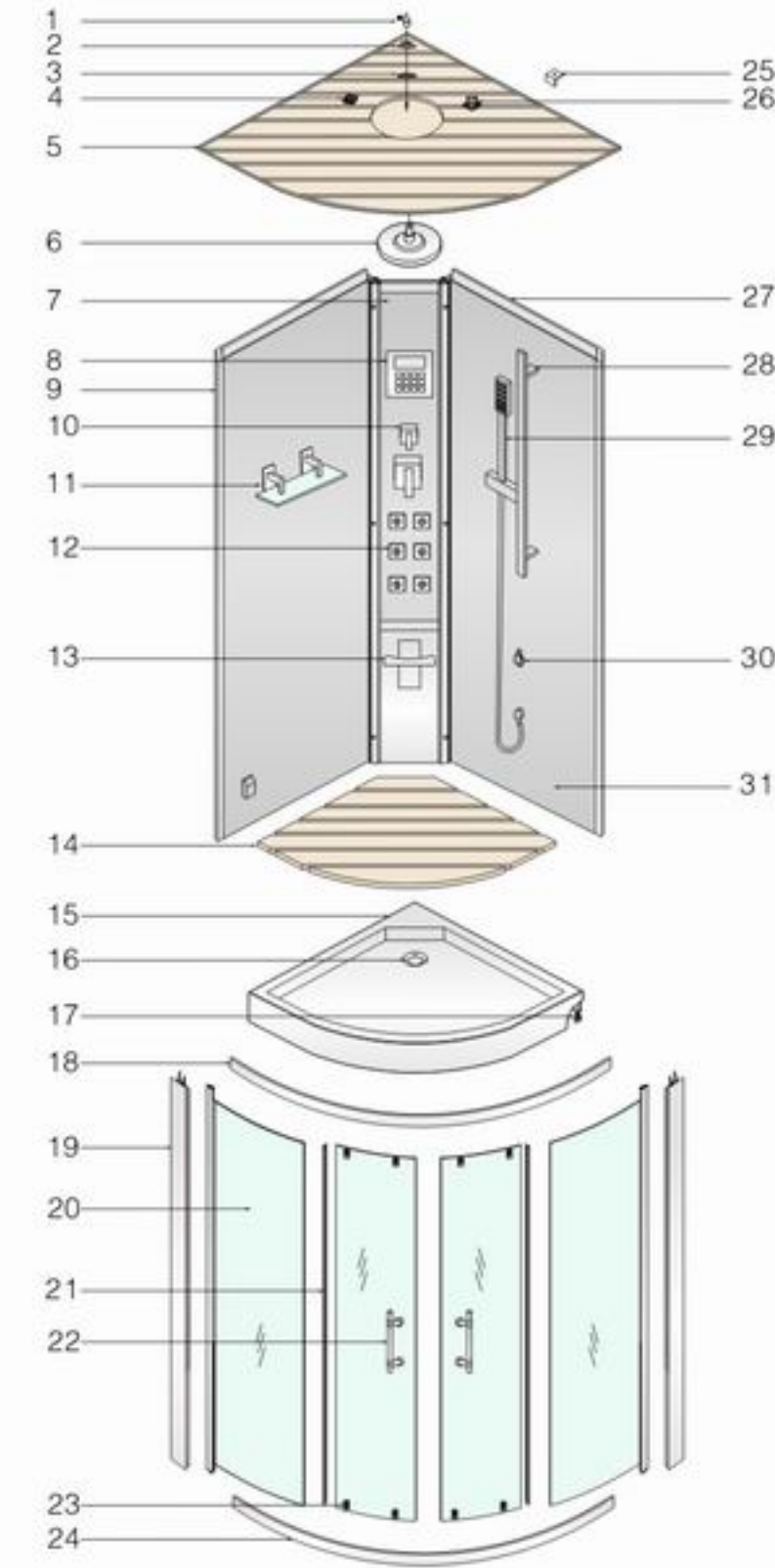

1、4"4 copper elbow	2、1/2" copper nuts	3、4mm plastic seal	4、Ventilator
			
5、Top cover	6、Head shower	7、Mid glass panel	8、F8 control panel
			
9、Side glass panel	10、Square 3 ways faucet	11、Shampoo holder	12、Jet
			
13、Seat	14、963 floor	15、Shower base	16、Plastic drainer
			
17、Adjustable leg	18、Upper	19、Conner aluminum	20、Fixed panel
			
21、L011B waterproof seal	22、Handle(big)	23、Wheels	24、Bottom aluminum track
			

Parts instruction

Parts package

25、962 block	26、Loud speaker	27、Right back panel
		
28、Hand shower bracket	29、1560 hand shower	30、Cleaning cup
		
31、Steam outlet		
		

945 Iron supporter: 2pcs	4x10mm self-locking screw: 29pcs
	
962 Block: 7pcs	Back panels small cover: 6pcs
	
3.5x30 Self-drilling screws: 8pcs	4x16 Self-drilling screws: 6pcs
	
4x25 Self-drilling screws: 6pcs	3mm Hexangular wrench: 1pcs
	

Technical drawing for water and electricity

Size: DZ963F8:1000X1000X2260mm
 DZ964F8:950X950X2260mm
 DZ965F8:900X900X2260mm

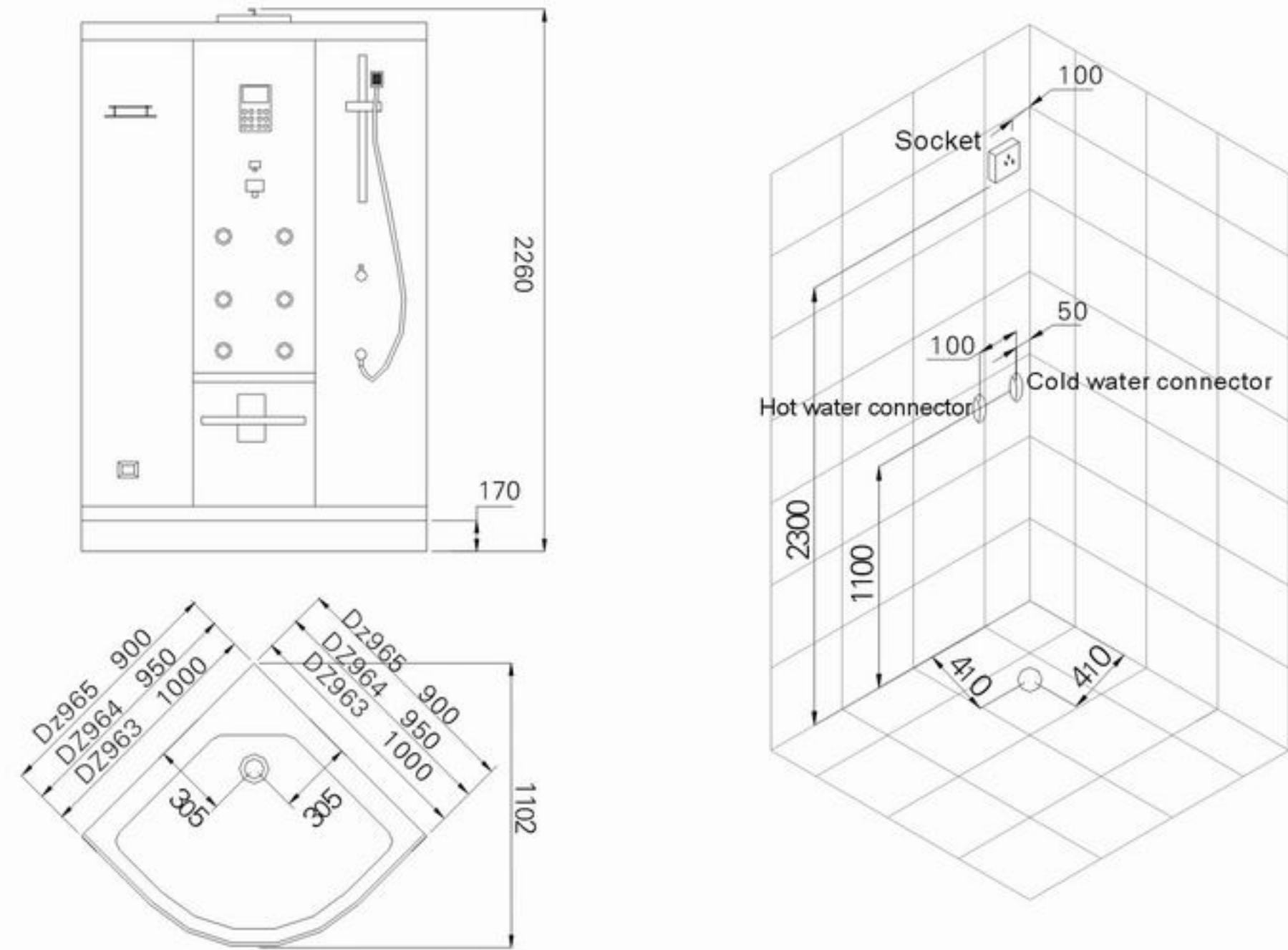

Installation instruction 1

- Install the shower base**
1. Take the shower base out from the carton and put it on the floor carefully. Please check it whether it is level.
 2. Put the level ruler on the shower base to check whether the shower base is level. If not, please adjust the adjusting legs to make the shower base become level. Illustrated in the drawing A.

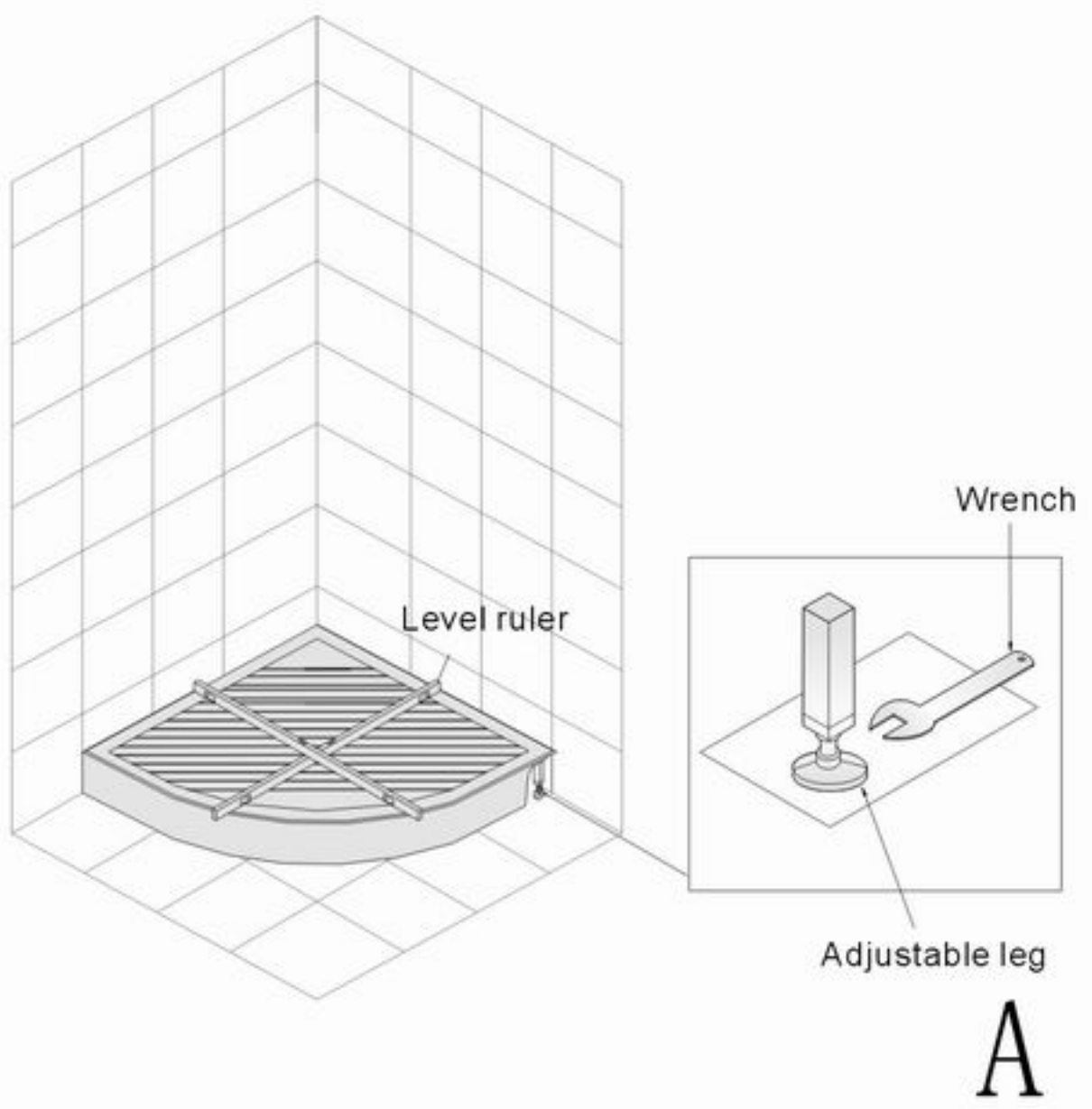

Installation instruction 2

- Install the back panels**
1. Take the No.1 panel out of the carton and put it on the shower base carefully. Please be sure to make one person stand beside to hold it on safely.
 2. Take the No.2 mid panel out and put it beside of the No.1 panel carefully. Insert the No.2 panel to the aluminum profile of No.1 panel. Then make one person hold on the No.1 and the No.2 panels, the other person uses a Philip Screwdriver to fix them with 4x25mm self-locking screws. Illustrated in drawing A. Then cover the small covers to the holes. Illustrated in the drawing B. Note: When users want to amend the spare parts behind of the mid-panel, just need to unscrew the screws in the small holes, then can take the mid-panel off from the base, no need to move the heavy steam shower room out.
 3. Use the same way to install the No.3 right side panel and fix it to the No.2 mid-panel. Also illustrated in the drawing A.
 4. Fix the Iron Supporter on to the No.1 panel and No.3 panel with 4x10mm self-locking screws. Illustrated in the drawing C.

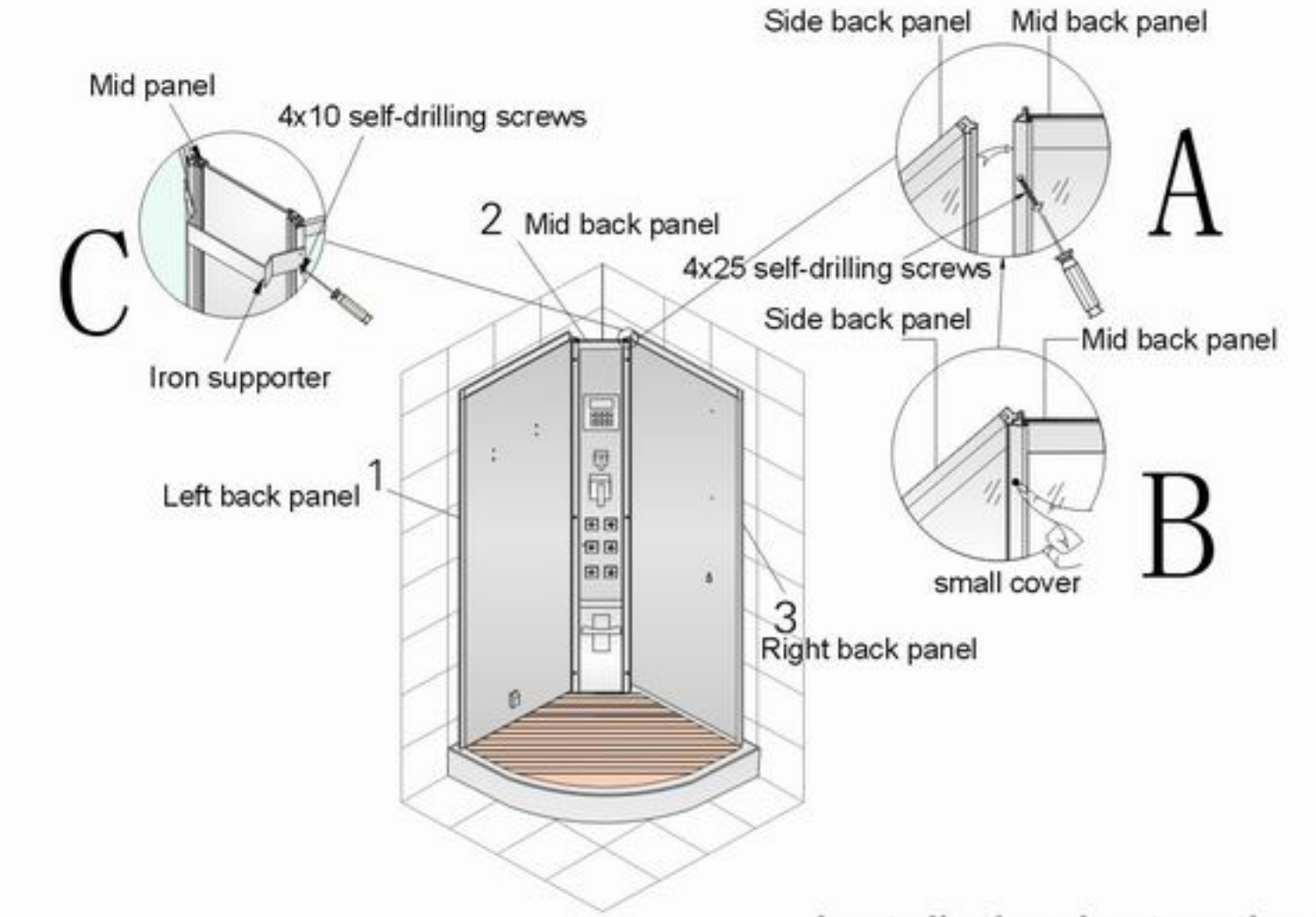

Installation instruction 3

Install front fixed glass doors

1. Put the No.1 lower aluminum track on the floor. Slide the No.3 right fixed door into the No.1 track, then use a Phillip Screwdriver to fix No.1 aluminum track and No.3 fixed door together with 3.5x30mm self-locking screws. Illustrate in the drawing A.
2. Slide the No.3 right door into the No.4 upper aluminum track, use a Phillip Screwdriver to fix them together with 3.5x30mm self-locking screws as well. Also according to the illustration in the drawing A.
3. Use the same way to install the No.2 left fixed door to the No.1 and No.4 aluminum tracks.

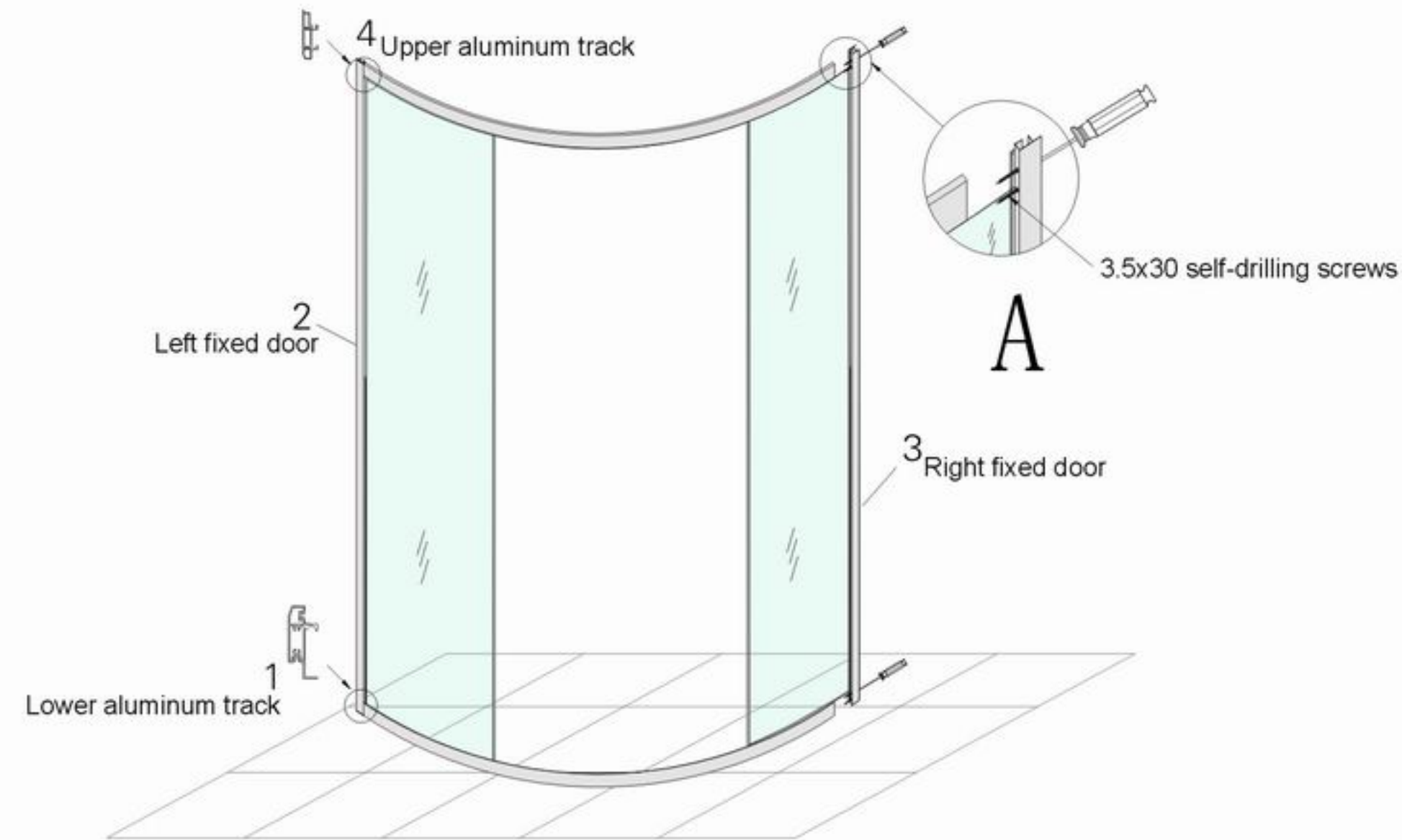

Installation instruction 4

Install the Fixed Glass Doors to the Back Panels and the Shower Base

1. Cover the No.5 right corner aluminum profile onto the No.3 right fixed glass doorframe (illustrated in drawings A). Use the same way to cover the No.6 left corner aluminum profile on the No.2 left fixed glass doorframe.
2. Please ask two persons to carry on the left and the right installed fixed glass doors, and put them on the shower base carefully. Then one person holds on the glass doors, the other person uses a Phillip Screwdriver to fix them to the left and the right back glass panels with 4x10mm self-locking screws. Illustrated in drawing B.

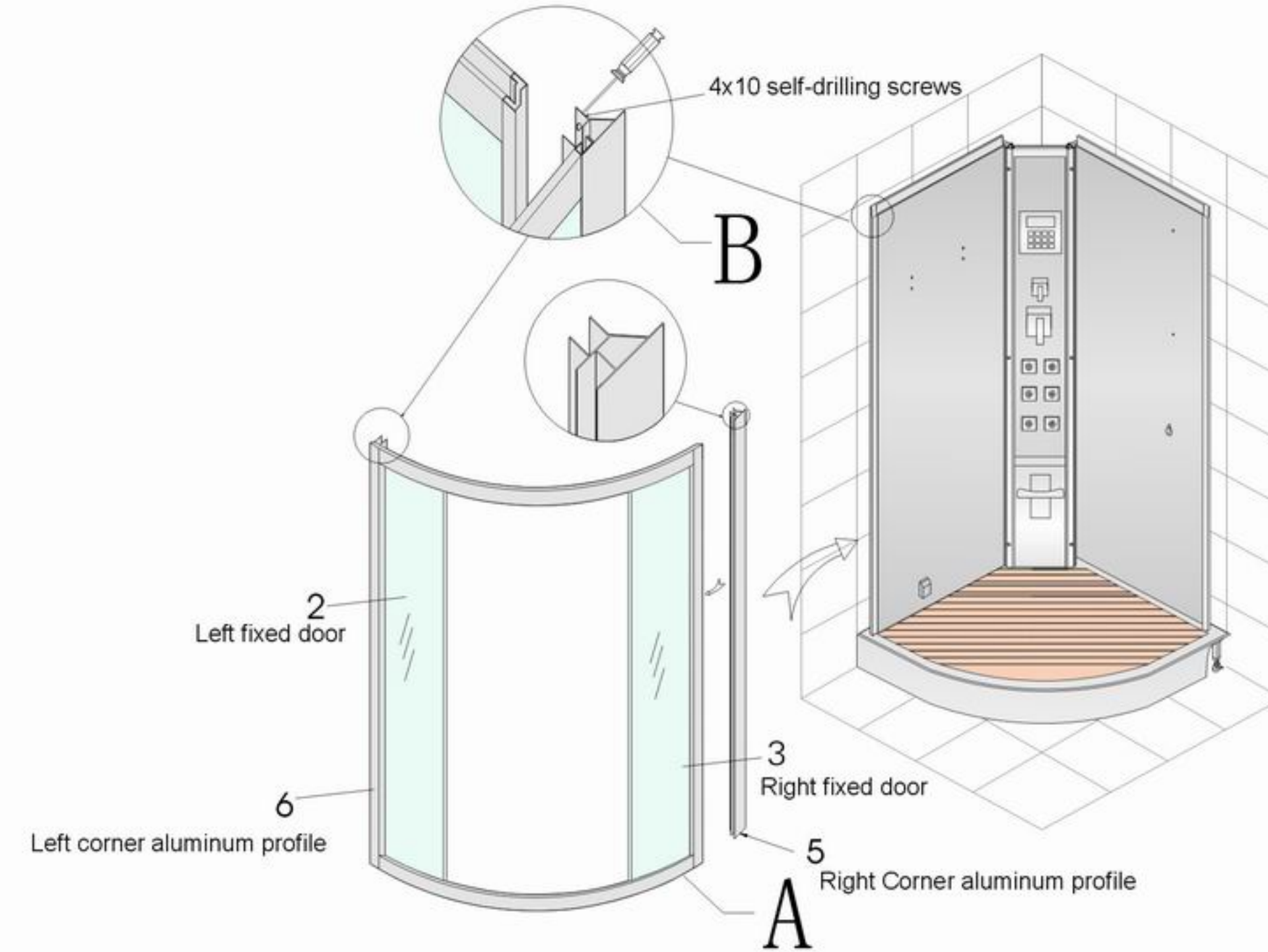

Installation instruction 5

Install Movable Door.

1. Fix the No.3 right fixed door and the No.2 left fixed door to the shower base with 4x10mm self-locking screws. Illustrated in the drawing E.
2. Insert the two plastic seals to the Movable Door. Illustrated in the drawing D.
3. Install Movable door: Hang up the movable door to the upper aluminum track (Illustrated in the drawing A), and then press the lower wheel to hook it into the lower aluminum track (Illustrated in the drawing B). Note: There is a Spring in the Upper Wheel. If there is a gap between the Movable Door and the Fixed Door, or the Movable Door can not swing very well, please adjust the Upper Wheels. Adjust Way: Use a Phillip Screwdriver to adjust the Screw at the bottom of the Upper Wheel, to make the Movable Door vertical.
4. Install the handles with a Hexangular Wrench. Illustrated in the drawing C.

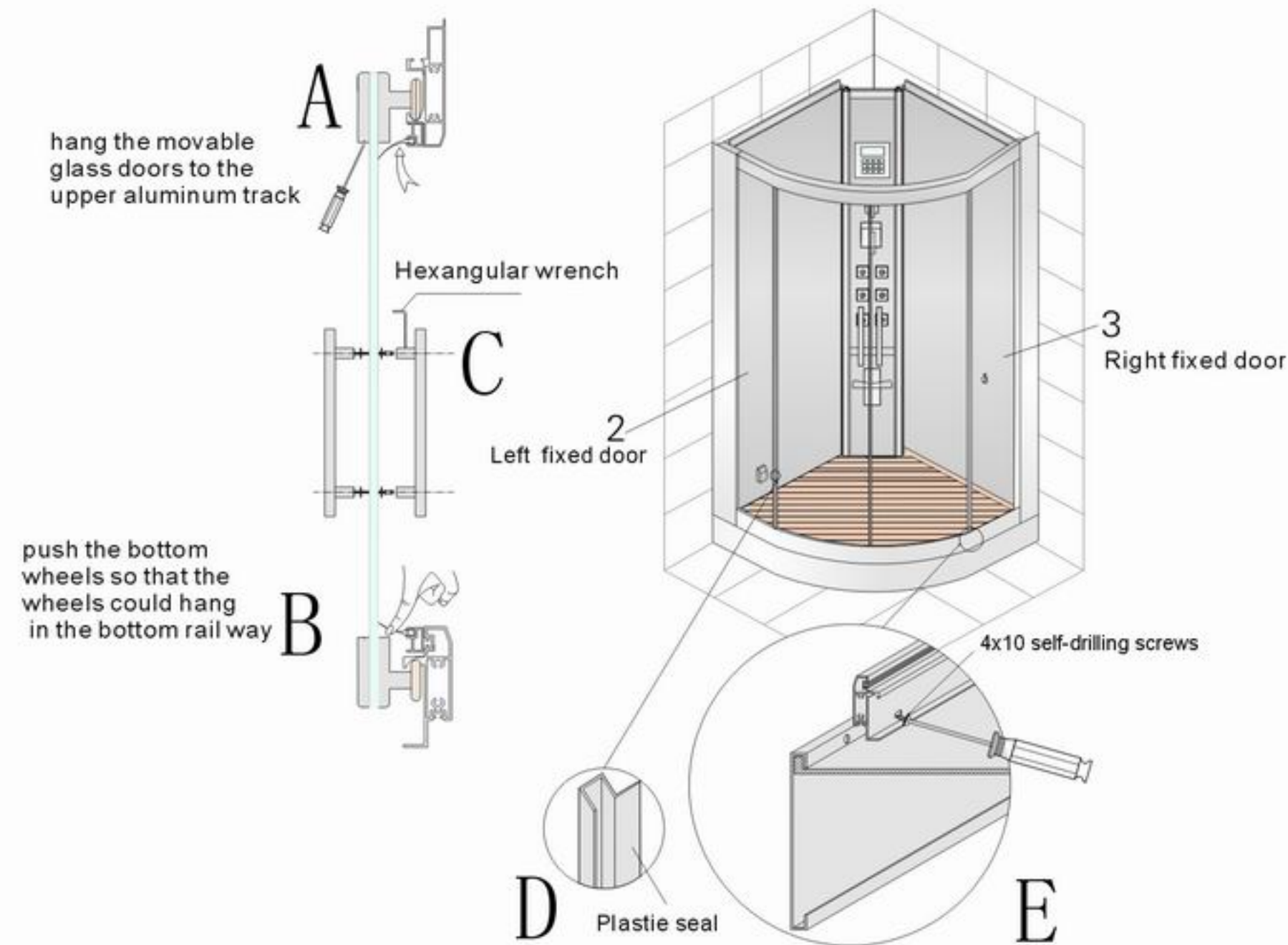

Installation instruction 6

Install Accessories

1. Install the Glass Shelf: Use a Phillip Screwdriver to fix the Glass Clip to the back panel with 4x16mm screws, 4mm plastic cushion, 6mm plastic cushion and 4mm nuts, illustrated in the drawing A. Then put the Glass Shampoo Holder on the track of Glass Clip and use a Phillip Screwdriver to fix them well. Illustrated in the drawing B.
2. Install the Up and Down Hand Shower Socket: Use a Phillip Screwdriver to install the Up and Down Hand Shower Socket to the back panel with 4x16mm screws, 4mm plastic cushion, 6mm plastic cushion and 4mm nuts. Illustrated in the drawing C.
3. Connect the hand shower chain to the hand shower socket. Illustrated in the drawing D.
4. Use a Phillip Screwdriver to fix the back panels to the base with 4x16mm self-locking screw, 4mm cushion, and the Aluminum Bloc. Illustrated in the drawing E.

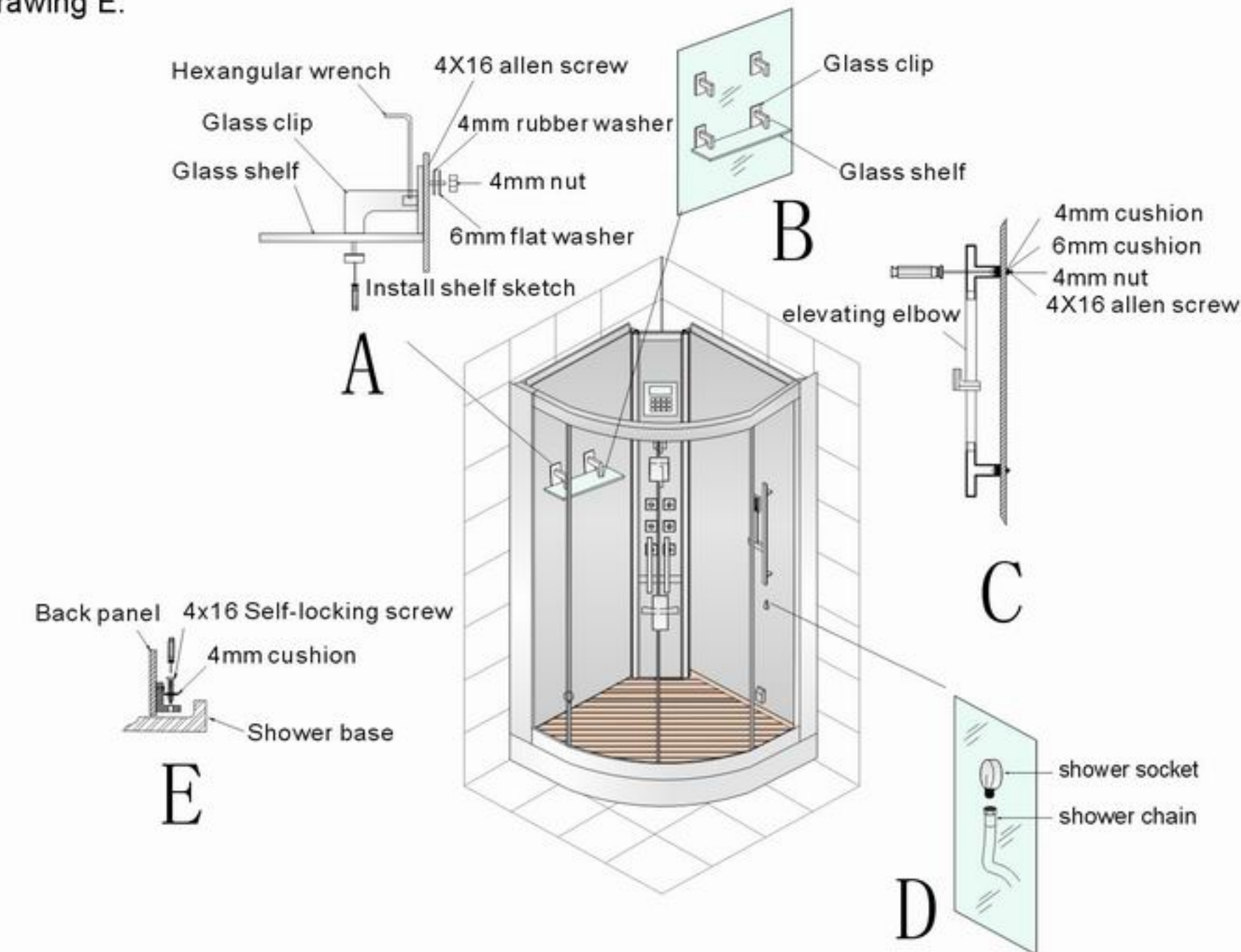

Installation instruction 7

Connect Wires

1. Put the top cover onto the steam shower carefully (Illustrated in the drawing A).
2. Use a Phillip Screwdriver to fix the Top Cover to Back Panels with 4x10mm self-locking screws and Stainless Steel Cushion. Illustrated in the drawing B.
3. Put the Solid Cherry Wood Floor in the steam shower carefully, put the stool on the floor.
4. Find out the Ventilator sign, the Lamp sign, and the Louder Speaker sign which are on the behind of the back panel, then connect the relative wires of these spare parts to the relative sockets. Illustrated in the following drawing.

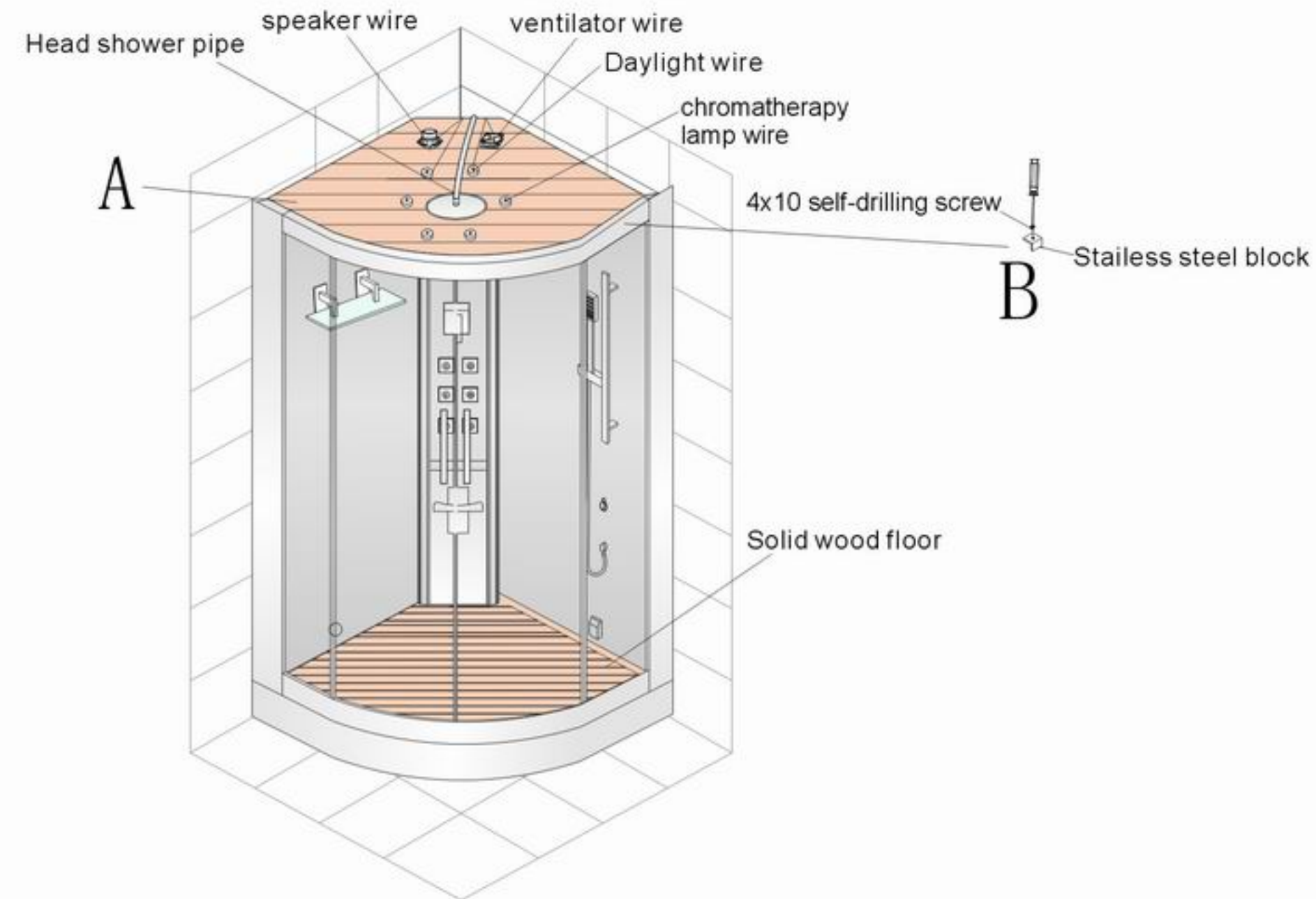

Installation instruction 8

Connect Fittings and Water Pipes

1. Connect the head shower pipe to the head shower joint. Connect the water outlet pipe to the shower base and connect the steam pipe to the steam outlet, illustrated in the drawing A.
2. Connect the hot water inlet pipe and the cold water inlet pipe separately to the relative joints. Illustrated in drawing A, B and C.
3. Especially note: The thermostatic faucet is an optional function, just when customers require to install this spare part and we will do, the standard steam shower is without the thermostatic function. Illustrated in drawing D and E.

Note: Before use the steam shower, please try to test whether all the functions are ok.

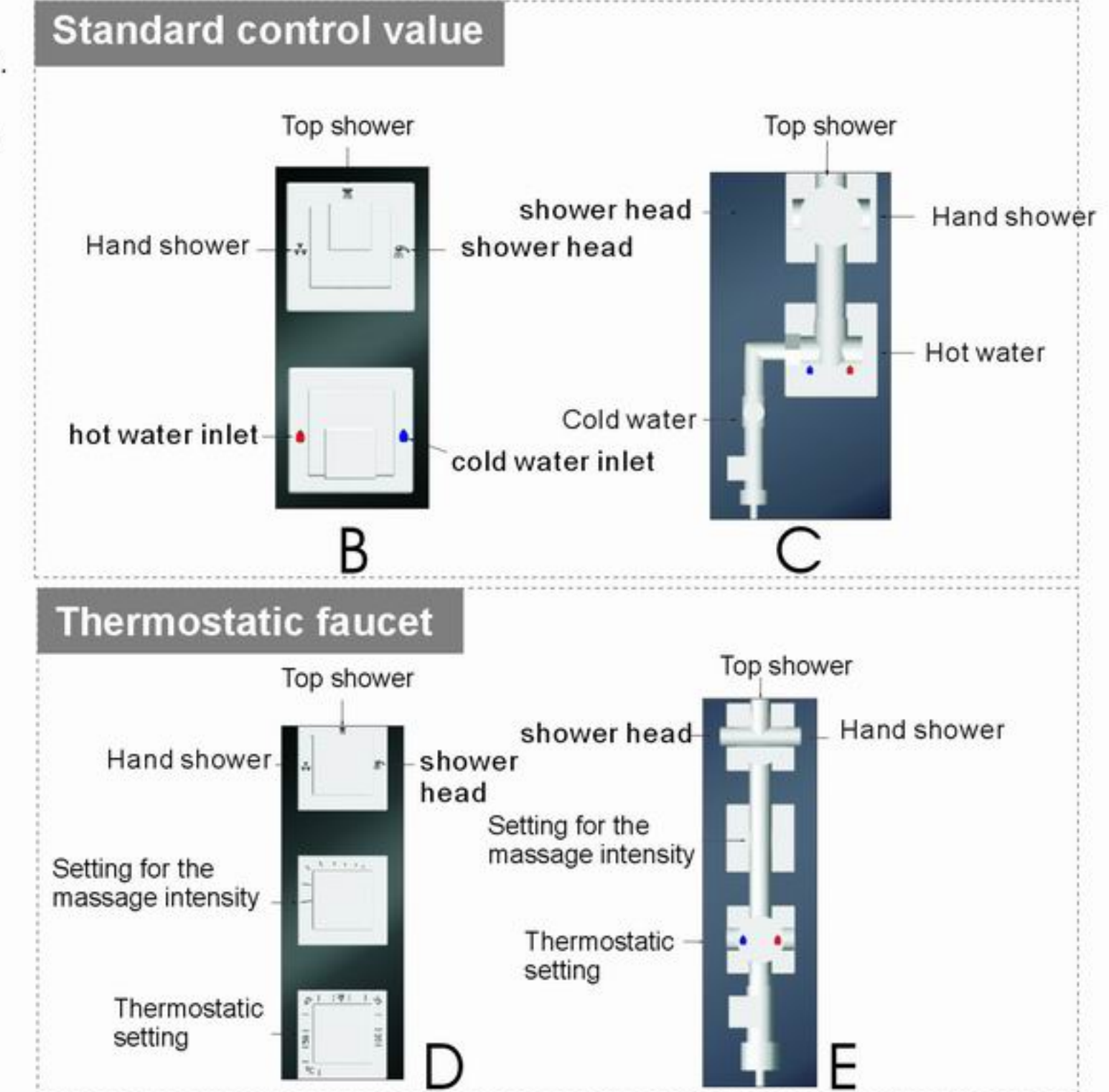
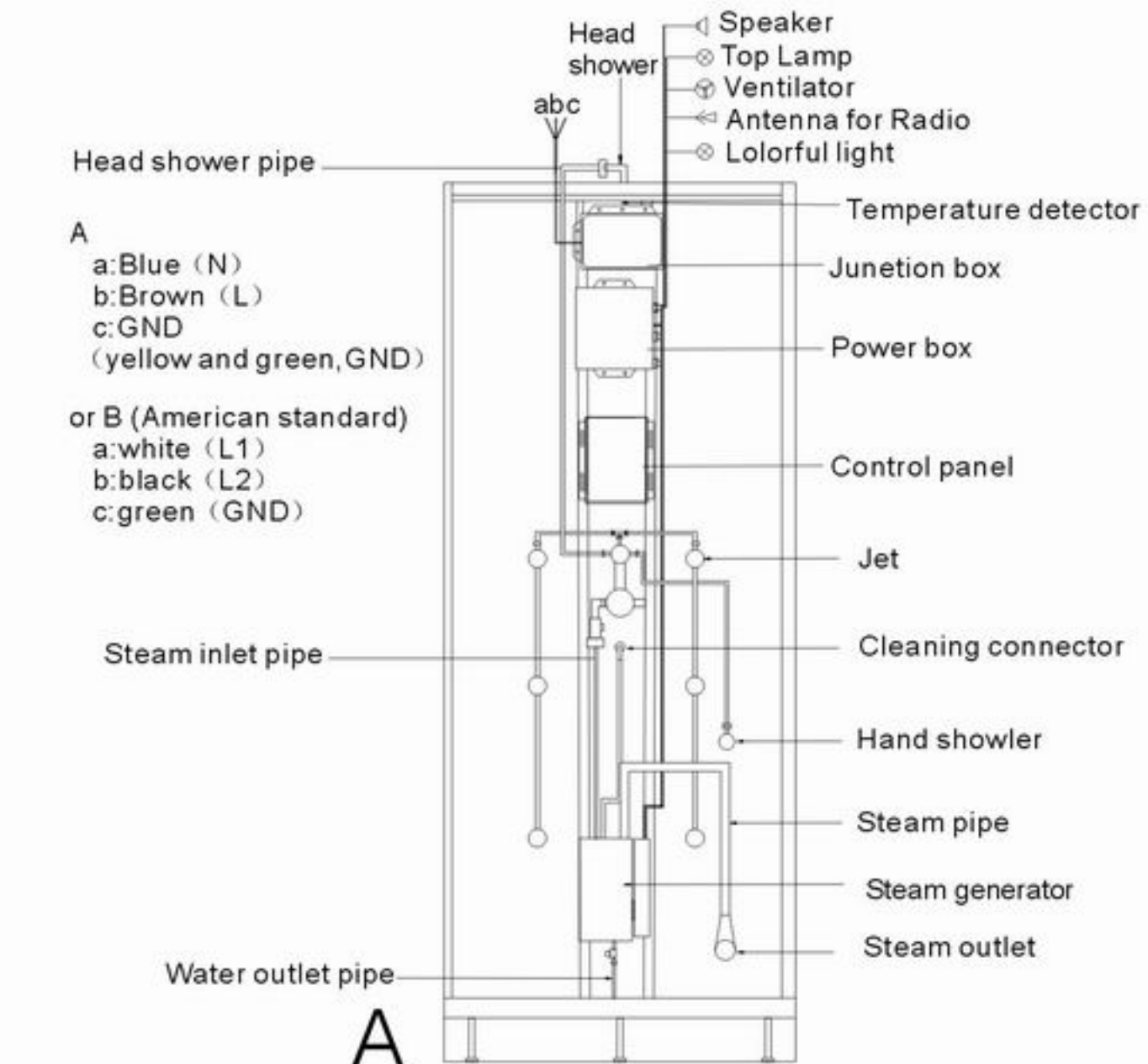

F8 Control panel keys and operating instructions

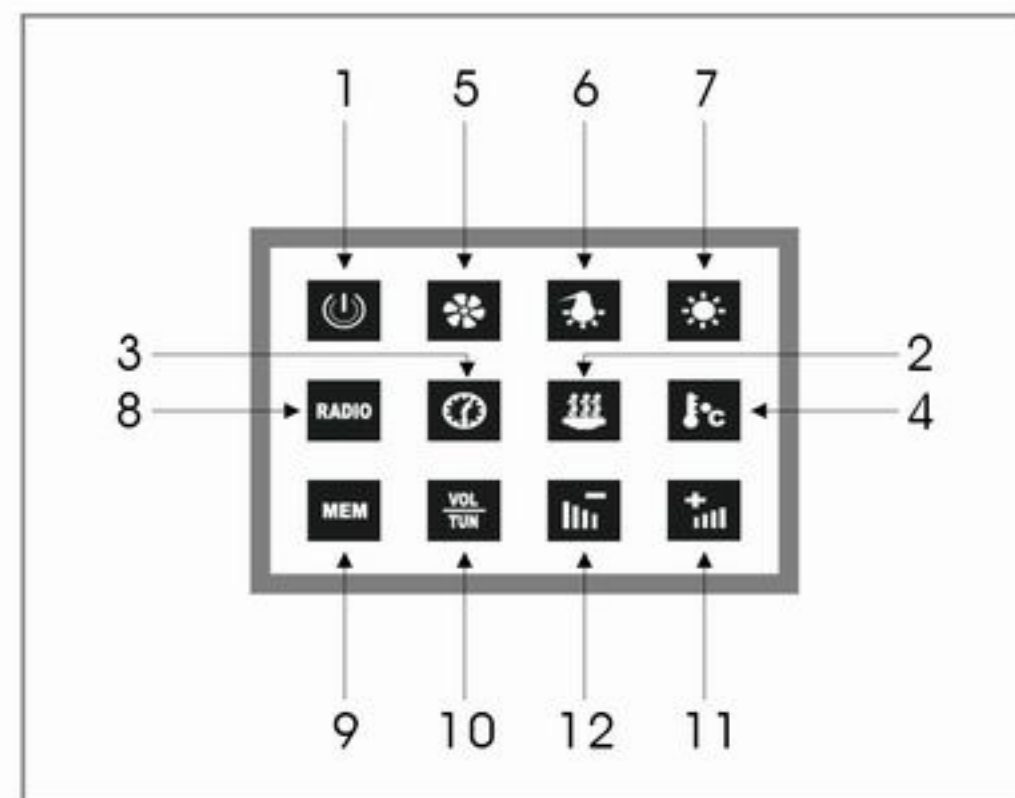

1).Power key

Press to switch on the steam room, press again to switch it off. The steam room will shut down in 60 minutes automatically. (As picture 1)



2).Steam key

Press The steam generator starts working. The temperature will be shown on the control panel like the No.2 picture.



3).Time adjusting

After the steam function is turned on, press will increase the setting time. When press the more than 1 second, the setting time will be increased continuously until you stop pressing. Or, just when it reaches the maximum limiting time (50 minutes) and then it will return to the minimum limiting time (5 minutes) automatically. Note: The time setting range is between 5-50 minutes. The default time setting is 30 minutes.



4).Temperature adjusting key

After steam function is turned on, press will increase the temperature. When press more than 1 second, the setting temperature will be increased continuously until you stop pressing. Or, just when it reaches the maximum limiting temperature and it will return to the minimum limiting temperature automatically. Note: The temperature setting range is between 20 °C-50°C. The controlled temperature tolerance: $\pm 3^{\circ}\text{C}$ The default temperature is 40°C.



5).Ventilator key

Press to turn on the ventilator, press again to turn off the ventilator.



6).Color light key

Press to turn on the color light. After the color light is turned on, each more press will change the different colors of the light. The color light works in this sequence: Turn on, blue ---blue and red ---red----red and orange---orange ---orange and blue---blue---circulating---turn off.



7).Lamp key

Press the key to turn on the lamp, press again and turn it off. (As picture 6)

8).Radio key

Press to turn on the radio, press again to turn off the radio. (As picture 7)



9).Channel memory key

Press and release within 1 second, the frequency of current channel will be changed; Press and hold it more than 1 second, the frequency of current channel will be saved. It can memory total 8 channels.

F8 control panel key and operation instructio

10).Select key

This key gets double functions. When the radio is turned on, this key shows the Frequency function. Press the key and it can be switched from the frequency to the volume function. Press the key, on the Displayer will show like the (Picture 10) or (picture 9). (picture 9) is for volume and (picture 10) is for frequency.

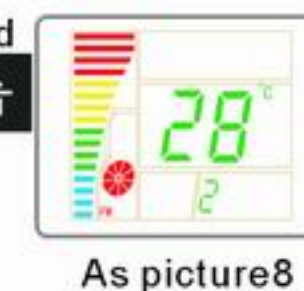

11).Volume up key

After the radio is turned on, (Picture 9) showed on the displayer, press will increase the volume. Hold on the key more than 1 second, volume will keep increasing until the key is released. When (picture 10) shows on the displayer, press will increase the frequency. Hold on the key more than 1 second, the frequency will keep increasing until the key is released.

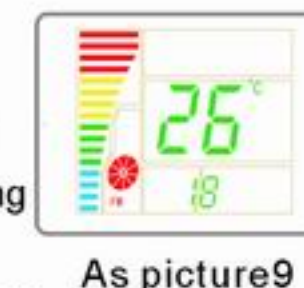

12).Volume down key

After the radio is turned on, when (Picture 9) is shown on the displayer, press will decrease the volume. Hold on the key more than 1 second, volume will keep decreasing until the key is released. When (picture 10) is shown on the displayer, press will decrease the frequency. Hold on the key more than 1 second, the frequency will keep decreasing until the key is released.



User's manual for cleaning the steem generator

Using steps: Turn off the power first, and then open the lid of cleaning cup, put the cleaning liquid in the cleaning cup, after that, cover the lid back. Now turn on the power, start the steam function to make the self-cleaning function work, later turn off the power, and pipe water away.

1).Power off

For safety, it is strictly prohibited to open the lid of the easy cleaning cup during using. In order to avoid steam gas emits out and scald users, please shut down all other functions before using the steam generator  cleaning function. (As picture 11)

2).Open the easy cleaning cup

After Making sure all of functions are turned off, find out the cleaning cup according the right picture illustrated, and rotate the lid of the cleaning cup to the reverse direction, and then take the lid out slightly. (As picture12)



3).put the cleaning liquid

After opening the cleaning cup, use a spoon to take a proper amount of cleaning liquid, such as Citric acid, or neutral compound cleaning liquid (around 5 ml) to put in the cleaning cup. Note: If the cleaning material is solid, first, please dissolve it with water to prevent blocking.Strictly prohibit to use any other acid, alkaline compounds to be poured into the cleaning cup directly(As picture13).



4).Cover the lid

After adding the cleaning liquid, cover the lid back and turn it in clockwise direction to fasten,like this can prevent the steam emitting out to scald users(As picture14).

5).Turn on and start the steam function

After covering the lid, press  to turn on the steam generator function, and the system  will begin to clean the steam box automatically.(As picture15)

6).Turn off the power and drain out the waste water

After 5-10 minutes, press the  to turn off the steam generator, then press the , the waste water will be drained out automatically(As picture16).



As picture 11



As picture 12



As picture 13



As picture 14



As picture 15

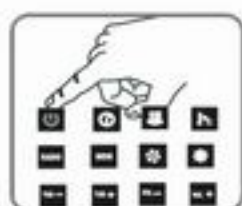

As picture 16

Notice:

1. Strictly prohibit to use the cleaning function while any other function is on;
2. Strictly prohibit to use any other alkaline cleaning compound to clean steam generator;
3. Strictly prohibit to use any solid cleaning agent to clean steam generator, in order to avoid blocking the pipe.

We recommend that you use citric acid solution to clean steam generator!

Maintenance service card

Item number			
Serial number		Purchasing date	
Phone number			

Eago guarantees to keep:

Eago series' products in good repair against the maintenance service card and purchasing receipt since the purchasing date. If it is the product quality problem, it will be free maintenance or change the spare parts. If the problem is not caused by the products itself or over-exceed the one-year guarantee, it will charge the repairing fees and spare parts costs.

The first page is kept for the customer.

Maintenance service card

Item number	
Serial number	
Customer name	
Phone number	
Address	
Agent shop	
Phone number	
Purchasing date	

The second page is sent back to eago head office.

Maintenance service card

Item number	
Serial number	
Customer name	
Phone number	
Address	
Agent shop	
Phone number	
Purchasing date	

Steam shower room trouble shooting

Malfunction Status	Reasons	Solutions
Small volume inlet water	<ol style="list-style-type: none"> 1. Lower inlet water pressure 2. The water inlet pipe is blocked 	<ol style="list-style-type: none"> 1. Check the inlet water pressure, then check with local plumber 2. Clean the filtre
Water divert valve can't divert water	<ol style="list-style-type: none"> 1. Rubber inside the valve damaged or distorted 	<ol style="list-style-type: none"> 1. Change a new one
No signal on the control panel	<ol style="list-style-type: none"> 1. There is no power in the user's house or the wire not connected well 2. Not switch the power on 3. The connecting wire for the control panel becomes loose 	<ol style="list-style-type: none"> 1. Need to wait the power on, connect wires in right way 2. Swtich on the power 3. Take it off and install it again, don't forget fasten it
There is steam signal on the control panle, but no steam comes out	<ol style="list-style-type: none"> 1. The Temperature limiter operate or the heater is broken 	<ol style="list-style-type: none"> 1. Ask help to qualified people
Chromatherapy light doesn't work	<ol style="list-style-type: none"> 1. The connecting wire blew out or the lamp holder loosen 2. Lamp pannel is broken 	<ol style="list-style-type: none"> 1. Change a new one or install it well again 2. Change a new one
Ventilator doesn't work	<ol style="list-style-type: none"> 1. The connecting wire is off 2. The fan blade gets stuck 3. The ventilation fan is broken 	<ol style="list-style-type: none"> 1. Reconnect it well 2. When the fan is on spur the blades slightly 3. Change a new one