

Leica Rugby CLH/CLA/CLI



User Manual
Version 1.0
English

- when it has to be **right**

Leica
Geosystems

Introduction

Purchase

Congratulations on the purchase of a Leica Rotating Laser product.



This manual contains important safety directions as well as instructions for setting up the product and operating it. Refer to "1 Safety Directions" for further information.

Read carefully through the User Manual before you switch on the product.



Product identification

The model and serial number of your product are indicated on the type plate. Always refer to this information when you need to contact your agency or Leica Geosystems authorised service centre.

Validity of this manual

This manual applies to the Rugby CLH/CLA/CLI lasers. Differences between the models are marked and described.

Available documentation

Name	Description/Format		
Rugby CLH/CLA/CLI Quick Guide	Provides an overview of the product. Intended as a quick reference guide.	✓	✓
Rugby CLH/CLA/CLI User Manual	All instructions required in order to operate the product to a basic level are contained in the User Manual. Provides an overview of the product together with technical data and safety directions.	-	✓

Refer to the following resources for all Rugby CLH/CLA/CLI documentation/software:

- the Leica Rugby CD
- <https://myworld.leica-geosystems.com>



myWorld@Leica Geosystems (<https://myworld.leica-geosystems.com>) offers a wide range of services, information and training material.

With direct access to myWorld, you are able to access all relevant services whenever it is convenient for you.

Service	Description
myProducts	Add all products that you and your company own and explore your world of Leica Geosystems: View detailed information on your products and update your products with the latest software and keep up-to-date with the latest documentation.
myService	View the current service status and full service history of your products in Leica Geosystems service centres. Access detailed information on the services performed and download your latest calibration certificates and service reports.

Service	Description
mySupport	View the current service status and full service history of your products in Leica Geosystems service centres. Access detailed information on the services performed and download your latest calibration certificates and service reports.
myTraining	Enhance your product knowledge with Leica Geosystems Campus - Information, Knowledge, Training. Study the latest online training material on your products and register for seminars or courses in your country.
myTrustedServices	Add your subscriptions and manage users for Leica Geosystems Trusted Services, the secure software services, that assist you to optimise your workflow and increase your efficiency.

Calibration Certificate

Calibration Certificates are available in the following formats:

- Rugby CLH Certificate Blue can be downloaded on myWorld.
- Rugby CLA/CLI Certificate Silver can be found printed in every carrying case.

DRAFT

Table of Contents

1	Safety Directions	6
1.1	General	6
1.2	Definition of Use	7
1.3	Limits of Use	7
1.4	Responsibilities	7
1.5	Hazards of Use	8
1.6	Laser Classification	11
1.6.1	General	11
1.6.2	Rugby CLH	11
1.6.3	Rugby CLA	12
1.6.4	Rugby CLI	13
1.7	Electromagnetic Compatibility EMC	14
1.8	FCC Statement, Applicable in U.S.	16
2	Description of the System	18
2.1	System Components	18
2.2	Functionality Packages	19
2.3	Rugby Laser Components	22
2.4	Case Components	24
2.5	Setup	24
3	Operation	26
3.1	Control Panel	26
3.2	Turning the Rugby on and off	26
3.3	The LCD Display	27
3.4	Grade Entry	28
3.5	Axis Identification	31
3.6	Conversion of Slope Into Percent of Grade	31
3.7	Alignment of the Axes	31
3.8	Precise Alignment of the Axes	32
3.9	Laydown Operation (Rugby CLA Only)	33
4	Combo	34
4.1	Description of the Combo	34
4.2	Connecting Screens for the Combo	36
4.3	Combo Menu	36
4.3.1	Access and Navigation	36
4.3.2	Menu Set 1	39
4.3.3	Menu Set 2	45
4.3.4	Grade Entry	49
5	The Rod Eye Receivers	53
5.1	Rod Eye 120, Receiver	53
5.2	Rod Eye 140, Classic Receiver	54
5.3	Rod Eye 160, Digital Receiver	55
6	Applications	56
6.1	Setting Forms	56
6.2	Checking Grades	56
6.3	Manual Grades	58
6.3.1	Manual Grades	58
6.3.2	Manual Grades with Slope Adapter	59
6.4	Batter Boards	59
6.5	Facades	62
6.6	Suspended Ceilings	64
6.7	Layout	66

6.8	Layout with Slope Catch	68
6.9	Grade Dial-in	70
6.10	Smart Target (Slope Catch)	71
6.11	Smart Target (Slope Lock)	71
6.12	Automatic Axis Alignment	72
6.13	Axis Alignment plus Slope Lock	75
6.14	Dual Receiver Setups	75
7	Batteries	77
7.1	Operating Principles	78
7.2	Battery for Rugby	78
7.3	Battery for Combo	80
8	Accuracy Adjustment	81
8.1	Checking the Level Accuracy	81
8.2	Adjusting the Level Accuracy	82
8.3	Adjusting the Vertical Accuracy	83
9	Semi-Automatic Calibration	85
10	Troubleshooting	89
11	Care and Transport	93
11.1	Transport	93
11.2	Storage	93
11.3	Cleaning and Drying	94
12	Technical Data	95
12.1	Conformity to National Regulations	95
12.2	General Technical Data of the Product	95
13	Lifetime Manufacturer's Warranty	98
13.1	Rugby CLH/CLA/CLI	98
13.2	Combo	98
14	Accessories	99

1 Safety Directions

1.1 General

Description

The following directions enable the person responsible for the product, and the person who actually uses the equipment, to anticipate and avoid operational hazards.

The person responsible for the product must ensure that all users understand these directions and adhere to them.

About warning messages





Warning messages are an essential part of the safety concept of the instrument. They appear wherever hazards or hazardous situations can occur.

Warning messages...

- make the user alert about direct and indirect hazards concerning the use of the product.
- contain general rules of behaviour.

For the users' safety, all safety instructions and safety messages shall be strictly observed and followed! Therefore, the manual must always be available to all persons performing any tasks described here.

DANGER, WARNING, CAUTION and **NOTICE** are standardised signal words for identifying levels of hazards and risks related to personal injury and property damage. For your safety, it is important to read and fully understand the following table with the different signal words and their definitions! Supplementary safety information symbols may be placed within a warning message as well as supplementary text.

Type	Description
 DANGER	Indicates an imminently hazardous situation which, if not avoided, will result in death or serious injury.
 WARNING	Indicates a potentially hazardous situation or an unintended use which, if not avoided, could result in death or serious injury.
 CAUTION	Indicates a potentially hazardous situation or an unintended use which, if not avoided, may result in minor or moderate injury.
NOTICE	Indicates a potentially hazardous situation or an unintended use which, if not avoided, may result in appreciable material, financial and environmental damage.
	Important paragraphs which must be adhered to in practice as they enable the product to be used in a technically correct and efficient manner.

1.2

Definition of Use

Intended use

- The Rugby CLH and Rugby CLI cast a horizontal laser plane or a laser beam for the purpose of alignment. The Rugby CLA casts a horizontal and vertical laser plane or a laser beam for the purpose of alignment.
 - The laser beam can be detected by means of a laser detector.
 - Remote control of product.
 - Data communication with external appliances.
-

Reasonably foreseeable misuse

- Use of the product without instruction.
 - Use outside of the intended use and limits.
 - Disabling safety systems.
 - Removal of hazard notices.
 - Opening the product using tools, for example screwdriver, unless this is permitted for certain functions.
 - Modification or conversion of the product.
 - Use after misappropriation.
 - Use of products with obvious damages or defects.
 - Use with accessories from other manufacturers without the prior explicit approval of Leica Geosystems.
 - Inadequate safeguards at the working site.
 - Deliberate dazzling of third parties.
 - Controlling of machines, moving objects or similar monitoring application without additional control and safety installations.
-

1.3

Limits of Use

Environment

Suitable for use in an atmosphere appropriate for permanent human habitation: not suitable for use in aggressive or explosive environments.

DANGER

Working in hazardous areas, or close to electrical installations or similar situations.

Life Risk.

Precautions:

- ▶ Local safety authorities and safety experts must be contacted by the person responsible for the product before working in such conditions.
-

1.4

Responsibilities

Manufacturer of the product

Leica Geosystems AG, CH-9435 Heerbrugg, hereinafter referred to as Leica Geosystems, is responsible for supplying the product, including the user manual and original accessories, in a safe condition.

Person responsible for the product

The person responsible for the product has the following duties:

- To understand the safety instructions on the product and the instructions in the user manual.
- To ensure that it is used in accordance with the instructions.
- To be familiar with local regulations relating to safety and accident prevention.
- To inform Leica Geosystems immediately if the product and the application becomes unsafe.
- To ensure that the national laws, regulations and conditions for the operation of the product are respected.

1.5

Hazards of Use

CAUTION

Dropping, misusing, modifying, storing the product for long periods or transporting the product

Watch out for erroneous measurement results.

Precautions:

- ▶ Periodically carry out test measurements and perform the field adjustments indicated in the User Manual, particularly after the product has been subjected to abnormal use as well as before and after important measurements.

DANGER

Risk of electrocution

Because of the risk of electrocution, it is dangerous to use poles, levelling staffs and extensions in the vicinity of electrical installations such as power cables or electrical railways.

Precautions:

- ▶ Keep at a safe distance from electrical installations. If it is essential to work in this environment, first contact the safety authorities responsible for the electrical installations and follow their instructions.



NOTICE

With the remote control of products, it is possible that extraneous targets will be picked out and measured.

Precautions:

- ▶ When measuring in remote control mode, always check your results for plausibility.

WARNING

Lightning strike

If the product is used with accessories, for example masts, staffs, poles, you may increase the risk of being struck by lightning.

Precautions:

- ▶ Do not use the product in a thunderstorm.

WARNING

Inadequate securing of the working site.

This can lead to dangerous situations, for example in traffic, on building sites and at industrial installations.

Precautions:

- ▶ Always ensure that the working site is adequately secured.
- ▶ Adhere to the regulations governing safety, accident prevention and road traffic.

CAUTION

Not properly secured accessories.

If the accessories used with the product are not properly secured and the product is subjected to mechanical shock, for example blows or falling, the product may be damaged or people can sustain injury.

Precautions:

- ▶ When setting up the product, make sure that the accessories are correctly adapted, fitted, secured, and locked in position.
- ▶ Avoid subjecting the product to mechanical stress.

CAUTION

Inappropriate mechanical influences to batteries

During the transport, shipping or disposal of batteries it is possible for inappropriate mechanical influences to constitute a fire hazard.

Precautions:

- ▶ Before shipping the product or disposing of it, discharge the batteries by running the product until they are flat.
- ▶ When transporting or shipping batteries, the person in charge of the product must ensure that the applicable national and international rules and regulations are observed.
- ▶ Before transportation or shipping contact your local passenger or freight transport company.

WARNING

During dynamic applications, for example stakeout procedures there is a danger of accidents occurring if the user does not pay attention to the environmental conditions around, for example obstacles, excavations or traffic.

Precautions:

- ▶ The person responsible for the product must make all users fully aware of the existing dangers.

WARNING

Unauthorised opening of the product

Either of the following actions may cause you to receive an electric shock:

- Touching live components
- Using the product after incorrect attempts were made to carry out repairs

Precautions:

- ▶ Do not open the product!
- ▶ Only Leica Geosystems authorised service centres are entitled to repair these products.

WARNING

Improper disposal

If the product is improperly disposed of, the following can happen:

- If polymer parts are burnt, poisonous gases are produced which may impair health.
- If batteries are damaged or are heated strongly, they can explode and cause poisoning, burning, corrosion or environmental contamination.
- By disposing of the product irresponsibly you may enable unauthorised persons to use it in contravention of the regulations, exposing themselves and third parties to the risk of severe injury and rendering the environment liable to contamination.

Precautions:

- ▶  The product must not be disposed with household waste. Dispose of the product appropriately in accordance with the national regulations in force in your country. Always prevent access to the product by unauthorised personnel.

Product-specific treatment and waste management information can be received from your Leica Geosystems distributor.

WARNING

Improperly repaired equipment

Risk of injuries to users and equipment destruction due to lack of repair knowledge.

Precautions:

- ▶ Only Leica Geosystems authorised service centres are entitled to repair these products.

⚠ WARNING

Exposure of batteries to high mechanical stress, high ambient temperatures or immersion into fluids

This can cause leakage, fire or explosion of the batteries.

Precautions:

- ▶ Protect the batteries from mechanical influences and high ambient temperatures. Do not drop or immerse batteries into fluids.

⚠ WARNING

Short circuit of battery terminals

If battery terminals are short circuited e.g. by coming in contact with jewellery, keys, metallised paper or other metals, the battery can overheat and cause injury or fire, for example by storing or transporting in pockets.

Precautions:

- ▶ Make sure that the battery terminals do not come into contact with metallic objects.

1.6

Laser Classification

1.6.1

General

General

The following chapters provide instructions and training information about laser safety according to international standard IEC 60825-1 (2014-05) and technical report IEC TR 60825-14 (2004-02). The information enables the person responsible for the product and the person who actually uses the equipment, to anticipate and avoid operational hazards.

- ☞ According to IEC TR 60825-14 (2004-02), products classified as laser class 1, class 2 and class 3R do not require:
 - laser safety officer involvement,
 - protective clothes and eyewear,
 - special warning signs in the laser working areaif used and operated as defined in this User Manual due to the low eye hazard level.
- ☞ National laws and local regulations could impose more stringent instructions for the safe use of lasers than IEC 60825-1 (2014-05) and IEC TR 60825-14 (2004-02).

1.6.2

Rugby CLH

General

The rotating laser built into the product produces a visible laser beam which emerges from the rotating head.

The laser product described in this section is classified as laser class 1 in accordance with:

- IEC 60825-1 (2014-05): "Safety of laser products"

These products are safe for momentary exposures but can be hazardous for deliberate staring into the beam. The beam may cause dazzle, flash-blindness and after-images, particularly under low ambient light conditions.

Description	Value
Maximum peak radiant power	0.6 mW / 3.5 mW
Pulse duration (effective)	500 ms / 1.4 ms, 0.7 ms
Pulse repetition frequency	10 Hz, 20 Hz
Beam divergence	0.2 mrad
Wavelength	635 nm

Labelling



a Laser beam

1.6.3

Rugby CLA

General

The rotating laser built into the product produces a visible laser beam which emerges from the rotating head.

The laser product described in this section is classified as laser class 2 in accordance with:

- IEC 60825-1 (2014-05): "Safety of laser products"

These products are safe for momentary exposures but can be hazardous for deliberate staring into the beam. The beam may cause dazzle, flash-blindness and after-images, particularly under low ambient light conditions.

Description	Value
Maximum peak radiant power	0.8 mW / 2.8 mW
Pulse duration (effective)	Rotating: 500 ms / 5.6 ms, 2.9 ms, 1.4 ms, 1.0 ms, 0.7 ms Scanning: 34 ms, 36 ms, 40 ms
Pulse repetition frequency	0 Hz, 2 Hz, 5 Hz, 10 Hz, 15 Hz, 20 Hz
Beam divergence	0.2 mrad
Wavelength	635 nm

CAUTION

Class 2 laser product

From a safety perspective, class 2 laser products are not inherently safe for the eyes.

Precautions:

- ▶ Avoid staring into the beam or viewing it through optical instruments.
- ▶ Avoid pointing the beam at other people or at animals.

Labelling

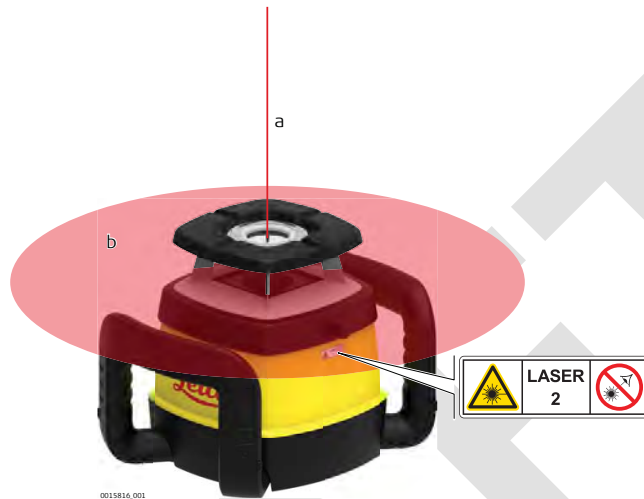

- a Laser beam, Plumb beam
- b Rotating laser beam

1.6.4

Rugby CLI

General

The rotating laser built into the product produces an invisible laser beam which emerges from the rotating head.

The laser product described in this section is classified as laser class 1 in accordance with:

- IEC 60825-1 (2014-05): "Safety of laser products"

These products are safe for momentary exposures but can be hazardous for deliberate staring into the beam. The beam may cause dazzle, flash-blindness and after-images, particularly under low ambient light conditions.

Description	Value
Maximum peak radiant power	3.5 mW
Pulse duration (effective)	1.4 ms, 1.0 ms, 0.7 ms
Pulse repetition frequency	10 Hz, 15Hz, 20 Hz
Beam divergence	0.2 mrad
Wavelength	780 nm



a Invisible laser beam

1.7

Electromagnetic Compatibility EMC

Description

The term Electromagnetic Compatibility is taken to mean the capability of the product to function smoothly in an environment where electromagnetic radiation and electrostatic discharges are present, and without causing electromagnetic disturbances to other equipment.

WARNING

Electromagnetic radiation

Electromagnetic radiation can cause disturbances in other equipment.

Precautions:

- ▶ Although the product meets the strict regulations and standards which are in force in this respect, Leica Geosystems cannot completely exclude the possibility that other equipment may be disturbed.

CAUTION

Use of the product with accessories from other manufacturers. For example field computers, personal computers or other electronic equipment, non-standard cables or external batteries

This may cause disturbances in other equipment.

Precautions:

- ▶ Use only the equipment and accessories recommended by Leica Geosystems.
- ▶ When combined with the product, they meet the strict requirements stipulated by the guidelines and standards.
- ▶ When using computers, two-way radios or other electronic equipment, pay attention to the information about electromagnetic compatibility provided by the manufacturer.

⚠ CAUTION

Intense electromagnetic radiation. For example, near radio transmitters, two-way radios or diesel generators

Although the product meets the strict regulations and standards which are in force in this respect, Leica Geosystems cannot completely exclude the possibility that function of the product may be disturbed in such an electromagnetic environment.

Precautions:

- ▶ Check the plausibility of results obtained under these conditions.

⚠ CAUTION

Operating the product with connecting cables attached at only one of their two ends

If the product is operated with connecting cables attached at only one of their two ends, for example external supply cables, interface cables, the permitted level of electromagnetic radiation may be exceeded and the correct functioning of other products may be impaired.

Precautions:

- ▶ While the product is in use, connecting cables, for example product to external battery, product to computer, must be connected at both ends.

⚠ CAUTION

Use of product with radio or digital cellular phone devices

Electromagnetic fields can cause disturbances in other equipment, in installations, in medical devices, for example pacemakers or hearing aids and in aircraft. It can also affect humans and animals.

Precautions:

- ▶ Although the product meets the strict regulations and standards which are in force in this respect, Leica Geosystems cannot completely exclude the possibility that other equipment can be disturbed or that humans or animals can be affected.
- ▶ Do not operate the product with radio or digital cellular phone devices in the vicinity of filling stations or chemical installations, or in other areas where an explosion hazard exists.
- ▶ Do not operate the product with radio or digital cellular phone devices near to medical equipment.
- ▶ Do not operate the product with radio or digital cellular phone devices in aircraft.

⚠ WARNING

This equipment has been tested and found to comply with the limits for a Class B digital device, pursuant to part 15 of the FCC rules.

These limits are designed to provide reasonable protection against harmful interference in a residential installation.

This equipment generates, uses and can radiate radio frequency energy and, if not installed and used in accordance with the instructions, may cause harmful interference to radio communications. However, there is no guarantee that interference will not occur in a particular installation.

- Reorient or relocate the receiving antenna.
- Increase the separation between the equipment and the receiver.
- Connect the equipment into an outlet on a circuit different from that to which the receiver is connected.
- Consult the dealer or an experienced radio/TV technician for help.

⚠ CAUTION

Changes or modifications not expressly approved by Leica Geosystems for compliance could void the user's authority to operate the equipment.

Labelling Rugby CLH/CLA/CLI



0015817_001

Labelling Combo

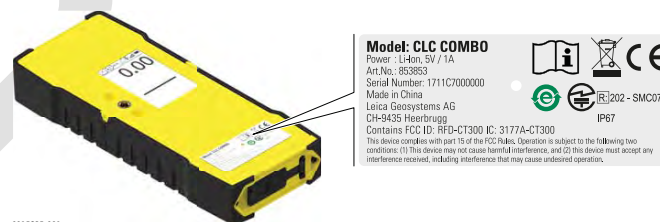

0015825_001



Labelling Rod Eye

Rod Eye 120



Model: RE120
 Power : 3V === / 60mA
 Art.No.: 785490
 Made in China
 Leica Geosystems AG
 CH-9435

This device complies with part 15 of the FCC Rules. Operation is subject to the following two conditions: (1) This device may not cause harmful interference, and (2) this device must accept any interference received, including interference that may cause undesired operation.

  
 IP67 CE

012524.002



Labelling Rod Eye

Rod Eye 140:



Model: RE140
 Power : 3V === / 60mA
 Art.No.: 828507
 Made in China
 Leica Geosystems AG
 CH-9435

This device complies with part 15 of the FCC Rules. Operation is subject to the following two conditions: (1) This device may not cause harmful interference, and (2) this device must accept any interference received, including interference that may cause undesired operation.

  
 IP67 CE

005146.002



Labelling Rod Eye

Rod Eye 160:



Model: RE160
 Power : 3V === / 60mA
 Art.No.: 785492
 Made in China
 Leica Geosystems AG
 CH-9435

This device complies with part 15 of the FCC Rules. Operation is subject to the following two conditions: (1) This device may not cause harmful interference, and (2) this device must accept any interference received, including interference that may cause undesired operation.

  
 IP67 CE

004661.002

2

Description of the System

2.1

System Components

General description

The Rugby CLH/CLA/CLI lasers are tools for general construction, levelling and slope applications such as:

- Setting forms
- Levelling to grade
- Controlling depths for excavations

If set up within the self-levelling range, the Rugby automatically levels to create an accurate horizontal, vertical or sloped plane of laser light. Once the Rugby has levelled, the head starts rotating and the Rugby is ready for use. 30 seconds after the Rugby has completed the levelling, the H.I.Alert system becomes active and protects the Rugby against changes in elevation caused by movement of the tripod to ensure accurate work.

Area of application

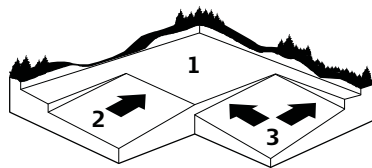

The Rugby CLH/CLA/CLI, depending on the configuration, is a dual grade laser. The laser produces an accurate plane of laser light for applications which require level (1), single slope (2) or dual slope (3).

Available system components





The delivered components depend on the package ordered.

2.2

Functionality Packages

Available functionality packages

A wide range of functionality packages are available for use on the Rugby CLH/CLA/CLI hardware. Depending on the installed package, certain features are available for use in a temporary or permanent state. Contact your dealer/supplier for further information.

Availability	Functionality package	
Permanent	<ul style="list-style-type: none"> • CLX001AG • CLX200 • CLX250 • CLX300 • CLX400 	<ul style="list-style-type: none"> • CLX500 • CLX600 • CLX700 • CLX800 • CLX900
Temporary	<ul style="list-style-type: none"> • CLX20 • CLX25 • CLX30 • CLX40 • CLX50 	<ul style="list-style-type: none"> • CLX60 • CLX70 • CLX80 • CLX90

Basic software features

The following basic software features are included in all CLX functionality packages:

Feature	CLX functionality packages
Horizontal	✓
Self-levelling $\pm 6^\circ$	✓
Accuracy $\pm 10''$	✓
Calibration	✓
Manual mode	✓
H.I.Alert	✓
Temperature alert 50 °C	✓
Battery alert	✓
Head stall alert	✓
Head speed 10	✓
Operating range (diameter) radio Combo 600 m	✓
Operating range (diameter) receiver Combo 1300 m	✓
50 h operating time on 1 charge	✓
Head speed 7, battery	✓

**Software features
Rugby CLH**

Depending on installed functionality package, the following features are usable:

Feature	CLX001AG	CLX200 CLX20	CLX300 CLX30	CLX400 CLX40
Manual slope DG ± 8%	-	✓	✓	✓
Slope Catch and Slope Lock	-	✓	✓	✓
Beam masking	✓	✓	✓	✓
Temperature stability control 2°C, 5°C, Off	✓	✓	✓	✓
Semi-automatic grade	✓	-	✓	✓
Grade dial-in ± 8%	-	-	✓	✓
Single grade	-	-	✓	✓
Dual grade	✓	-	-	✓
Grade dial-in ± 5%	✓	-	-	-
Head speed 15, 20	✓	-	-	-
Semi-automatic calibration	✓	-	-	-

**Software features
Rugby CLA**

Depending on installed functionality package, the following features are usable:

Feature	CLX250 CLX25	CLX500 CLX50	CLX600 CLX60	CLX700 CLX70	CLX800 CLX80
Manual slope DG ± 8%	✓	✓	✓	✓	✓
Slope Catch and Slope Lock	✓	✓	✓	✓	✓
Beam masking	✓	✓	✓	✓	✓
Temperature stability control 2°C, 5°C, Off	✓	✓	✓	✓	✓
Semi-automatic calibration	✓	✓	✓	✓	✓
Head speed 15	✓	✓	✓	✓	✓
Lay down operation	-	✓	✓	✓	✓
Scan catch	-	✓	✓	✓	✓
Scanning 10 °, 45 °, 90 °	-	✓	✓	✓	✓
Head Speed 0, 2, 5	-	✓	✓	✓	✓
Grade dial-in ± 15%	-	-	✓	✓	✓
Auto grade	-	-	✓	✓	✓
Single grade	-	-	✓	✓	✓
Axis alignment	-	-	✓	✓	✓
Dual grade ± 15%	-	-	-	✓	✓
Plumb up beam	-	-	-	✓	✓
Head speed 20	-	-	-	-	✓
Multiple laser operation with Combo, max. 5 lasers	-	-	-	-	✓

Software features Rugby CLI

CLX900 and CLX90 are the available functionality packages for Rugby CLI.
The following features are usable:

Feature	CLX900 CLX90
Manual slope DG \pm 8%	✓
Slope Catch and Slope Lock	✓
Beam masking	✓
Temperature stability control 2°C, 5°C, Off	✓
Semi-automatic calibration	✓
Head speed 15, 20	✓
Grade dial-in \pm 15%	✓
Auto grade	✓
Semi-automatic grade	✓
Axis alignment	✓
Plumb up beam	✓
Multiple laser operation with Combo, max. 5 lasers	✓
Dual grade IR \pm 15%	✓

2.3

Rugby laser components

Rugby Laser Components

Rugby CLH



- a Carry handle
- b Screen
- c Control panel
- d USB-C port, only for Rugby Manager software
- e Battery compartment

Rugby CLA



- a Vertical plumb window
- b Plate for optional scope
- c Carry handle
- d Screen
- e Control panel
- f USB-C port, only for Rugby Manager software
- g Battery compartment

Rugby CLI



- a Plate for optional scope
- b Carry handle
- c Screen
- d Control panel
- e USB-C port, only for Rugby Manager software
- f Battery compartment

DRAFT

2.4

Case Components

Case components



0015902_001

- a Rugby laser
- b User manual, CD, Safety instructions, Quick guide, Protect card
- c Combo with bracket
- d Power bank and cable*
- e Second battery*
- f Case label
- g Charger
- h Flexible name tag*
- i Scope assembly*
- j Rod Eye with bracket*

*Optional

2.5

Setup

Location

- Keep the location clear of possible obstructions that could block or reflect the laser beam.
- Place the Rugby on a stable ground. Ground vibration and extremely windy conditions can affect the operation of the Rugby.
- When working in a very dusty environment place the Rugby up-wind so the dirt is blown away from the laser.

Setting up on a tripod



1. Set up the tripod.
 2. Place the Rugby on the tripod.
 3. Tighten the screw on the underside of the tripod to secure the Rugby on the tripod.
- Attach the Rugby securely to a tripod or laser trailer, or mount on a stable level surface.
 - Always check the tripod or laser trailer before attaching the Rugby. Make sure all screws, bolts and nuts are tight.
 - If a tripod has chains, they should be slightly loose to allow for thermal expansion during the day.
 - Secure the tripod on extremely windy days.

3 Operation

3.1 Control Panel

Overview

Rugby CLA/CLI

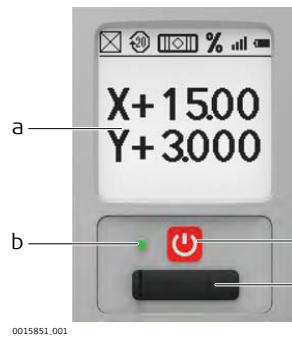

- a LCD display
- b Status LED
- c Power button
- d USB-C port, only for Rugby Manager software

Rugby CLH

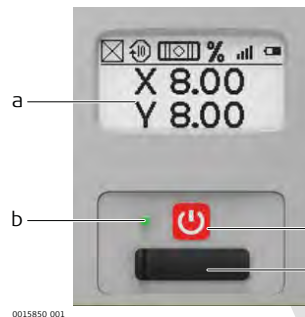

- a LCD display
- b Status LED
- c Power button
- d USB-C port, only for Rugby Manager software

Functions

LCD display	Displays all required user information.
Power button	Press to turn on or off the Rugby.
Status LED	Indicates the level status of the Rugby.

3.2 Turning the Rugby on and off

Turning on and off

Press the Power button to turn on or off the Rugby.

After turning on:

- The LCD display turns on and displays the current status of the Rugby.
- If set up within the $\pm 6^\circ$ self-levelling range (horizontal or vertical), the Rugby automatically levels to create an accurate horizontal plane of laser light.
- Once levelled, the head starts rotating and the Rugby is ready for use.
- The H.I.Alert system becomes active 30 seconds after completing the levelling. The H.I.Alert system protects the laser against changes in elevation caused by any movement or settling of the tripod.
- The self-levelling system and the H.I.Alert function continue to monitor the position of the laser beam to ensure consistent and accurate work.



The H.I.Alert function turns on automatically every time the Rugby is turned on.

3.3

The LCD Display

Main display

The LCD display shows all the information that is required to operate the Rugby. For a more comprehensive display, a Combo is necessary.

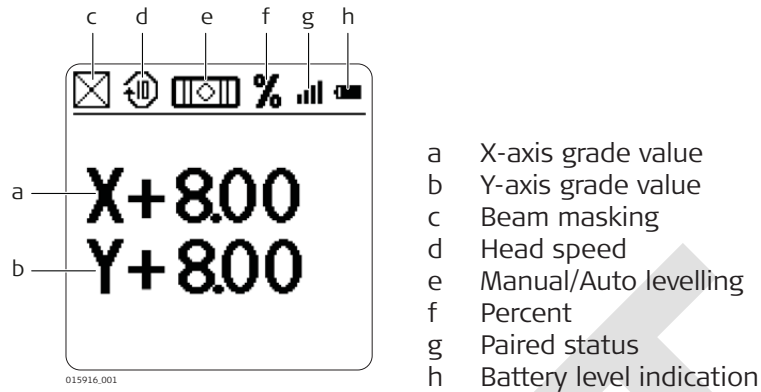

Start-up Screens

When you turn on the Rugby, the LCD displays the Leica welcome screen, the customer name screen and the information screen.

Leica welcome screen



Leica Customer name screen

☞ The screen only appears if you enabled it in the menu. Refer to 4.3.3 Menu Set 2-Customer name. It is limited to the Rugby CLA/CLI models only.



Leica Information screen

The information screen displays the serial number, software revision level and the hours of use until calibration.



Rugby CLH

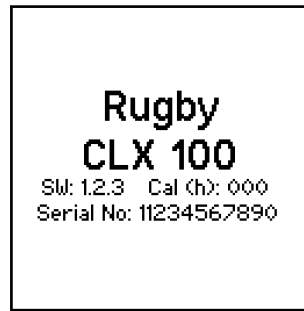

Rugby CLA/CLI

3.4

Grade Entry

Direct grade entry

1. **Rugby CLA/CLI:**
Press the OK/Grade button once to start grade entry mode.



Keypad of the Combo

The X-axis grade value is highlighted to begin.

Press the Down arrow/Sleep mode button to select the Y-axis grade value.

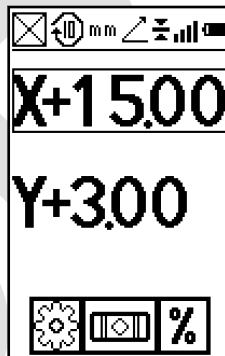

X-axis grade value

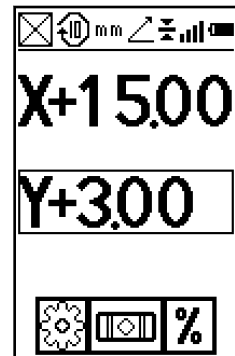

Y-axis grade value

2. Select the grade value.
3. Press the Up arrow/Menu button or Down arrow/Sleep mode button to change the grade value.
4. Press the OK/Grade button to confirm the selection.

- Press the Power/ESC button for a short time to exit grade entry mode.
The Main screen appears.

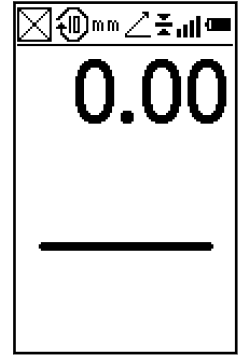

Grade entry by digit

While in grade entry mode, you can easily change the plus/minus sign or individual digits.

- Press the OK/Grade button to enter the grade entry mode.



Keypad of the Combo

- Select the axis and press the Left arrow/Bandwidth button or Right arrow/Volume button to create a cursor. The cursor always appears on the plus/minus sign.

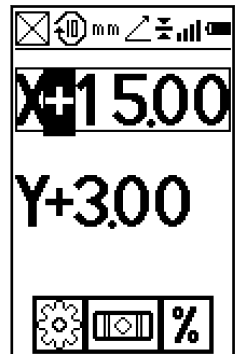

- Select the grade value.
- Press the Up arrow/Menu button or Down arrow/Sleep mode button to change the grade value. Press the Left arrow/Bandwidth button or Right arrow/Volume button to change a digit.

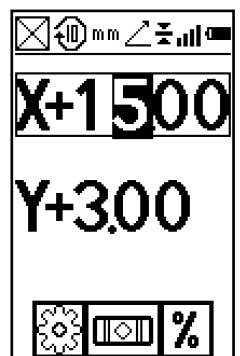

- Press the OK/Grade button to confirm the selection.

- Press the Power/ESC button for a short time to exit grade entry mode.
The Main screen appears.

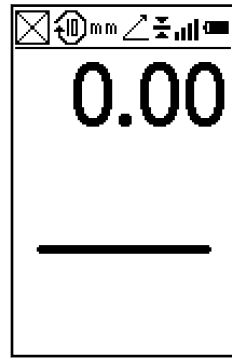

Reset grade value to zero

While in grade entry mode, you can quickly change the grade value back to zero by pressing the Up arrow/Menu button and Down arrow/Sleep mode button simultaneously.

Grade capability

Laser	Grade capability simultaneously in both axes	Grade capability in one axis
Rugby CLH with CLX001AG functionality package	up to 5%	-
Rugby CLH	up to 8%	up to 8%
Rugby CLA	up to 10%	up to 15%
Rugby CLI	up to 10%	up to 15%

 The grade capability depends on the functionality package in operation. Refer to 2.2 Functionality Packages.

Example: Rugby CLA

The Rugby CLA can have up to 10.00% grade simultaneously in both the X and Y axes or up to 15.00% grade in one axis.

Entering grades above 10.00% in one axis is only possible if the cross axis grade is $\pm 3\%$ or lower.

 If you try to enter grades greater than 3% or 10%, a notice appears on the screen when you press the button.

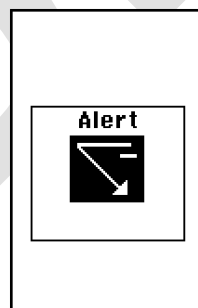

Grade swap

The grade in the X and Y axes can be swapped from positive to negative by changing the plus/minus sign in grade entry mode. Refer to 3.4 Grade Entry-Grade entry by digit.

A typical application for this feature is road building.

Example: The Rugby is set up on the crown of the road and one axis is aligned to the centreline. In order to make the cross axis grade fall to the right or left hand side, simply change the plus/minus sign on the display.

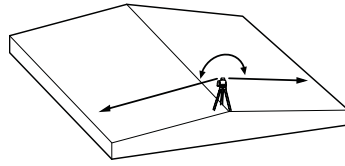

3.5

Axis Identification

Axis identification

When entering grade, it is important to know the correct direction in which the grade is being entered.

Refer to the following illustration to identify the correct directions of the axes.



0015852_001

3.6

Conversion of Slope Into Percent of Grade

Conversion of slope

Slope: The change in elevation per unit of measure (foot, metre, etc.)

Percent of Grade: The change in elevation per 100 units of measure (feet, metre, etc.)

Calculating percent of grade from slope:

$$[\text{Slope}] \times 100 = [\text{Percent of Grade}]$$



Example:

Slope	= 0.0059
Conversion	= 0.0059 x 100
Percent of Grade	= 0.590%

3.7

Alignment of the Axes

Aligning X- and Y-axis

1. Align the X-axis and Y-axis.
 2. Set the desired grade in the display.
-  Ensure that you first align the axes and then set the grade, otherwise the Rugby goes into an alert, for example HI.Alert.
 -  Ensure that the Rugby is properly positioned over a control point.

The direction of the X-axis is seen from the front of the Rugby, sighting over the top of the Rugby.



-
3. Rotate the Rugby slightly until the alignment marks are aligned with your second control point.

 For the Rugby CLA/CLI the Rugby sighting scope can be used to help with the alignment.

-
4. Once the Rugby is aligned, you can start working.
-

3.8

Precise Alignment of the Axes

Precisely aligning X- and Y-axis

Under most conditions, the raised alignment marks on the top of the Rugby are adequate for alignment of the axes. For a more precise alignment, you can use the following procedure.

Objective of a precise alignment:

- To establish Point A on the Y-axis as a reference and take an elevation reading.
- To enter grade into the X-axis and then adjust the position of the laser until the original elevation at Point A is again found.

1. With 0.000% grade in both axes, set up the Rugby directly over a grade stake and roughly align the Y-axis to a second grade stake (Point A).
2. Take an elevation reading at Point A using a Combo receiver and a survey rod.

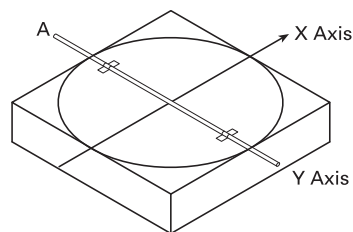

-
3. Enter +5.000% grade into the X-axis. When grade is entered into the X-axis, the Y-axis acts like a hinge or fulcrum.
-

4. With +5.000% in the X-axis, take a second reading at Point A.

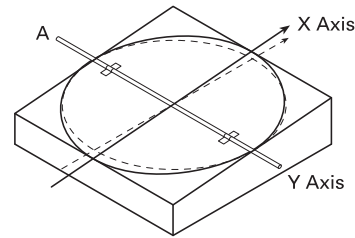

5. Alignment:
- If the second reading is equal to the first reading, the X-axis is aligned correctly.
 - If the second reading is greater than the first reading, rotate the Rugby clockwise (to the right) until the two readings are equal.
 - If the second reading is less than the first reading, rotate the Rugby counter-clockwise (to the left) until the two readings are equal.

 Sighting Scope - An optional sighting scope is available for the Rugby CLA/CLI which improves the axis alignment for second day setups. It is recommended that you first perform the precise alignment procedure, and then adjust the scope to these axes.

 Automatic Axis Alignment - Automatic axis alignment is possible with the Rugby CLA/CLI using the Combo receiver. (Refer to "6.12 Automatic Axis Alignment")

3.9

Laydown Operation (Rugby CLA Only)

Vertical plane of laser light

You can use the Rugby CLA in laying down position to create a vertical plane for layout and alignment jobs.



0016017.001
Rugby laying down position

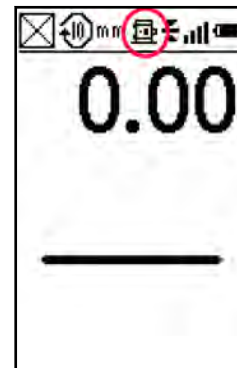

Combo laying down screen

 In laydown operation only manual grade change is possible.

4

Combo

4.1

Description of the Combo

Description

The Combo communicates with the Rugby via RF (radio frequency) and is used to control the functions of the Rugby.

Instrument components part 1 of 2



- a Audio speaker
- b Screen
- c Laser reception window
- d Centre marking
- e Keypad

Component	Description
Audio speaker	Indicates the detector's position: <ul style="list-style-type: none"> • High - Fast beeping • On-grade - Solid tone • Low - Slow beeping
Screen	Front and rear LCD arrow indicate the position of the detector.
Laser reception window	Detects the laser beam. The reception window must be directed towards the laser. Front and rear LCD indicate the position of the detector in relation to the beam, using arrows and the Digital Read Out values.
Centre marking	Indicates the on-grade position of the laser.
Keypad	Power, accuracy and volume functions.

Instrument components part 2 of 2



- a Bracket mounting hole
- b Centre notch
- c Product label
- d Battery door

Component	Description
Bracket mounting Hole	Location to attach the receiver bracket for normal operation.
Centre notch	Use to transfer reference marks. The notch is 85 mm (3.35") below to top of the detector.
Product label	The serial number is located on the product label.

Component	Description
Battery door	Battery compartment can only be opened by an authorised Leica service partner.

Keypad

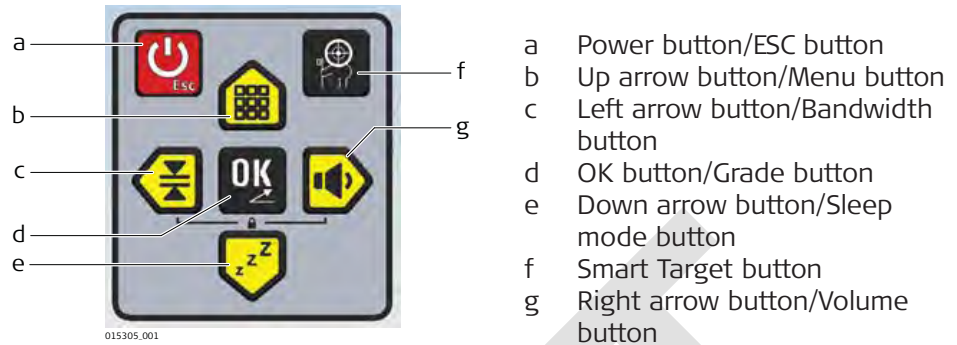

Description of the buttons

Button	Description
Power button/ESC button	Long press to turn on or off the Combo. Short press to leave a screen and return to the main screen.
Up arrow button/Menu button	Press to enter the menu. Press to navigate up in the menu.
Left arrow button/Bandwidth button	Press to toggle the bandwidth/sensitivity. Press to navigate left in the menu.
OK button/Grade button	Press to select or confirm an option. When on main screen, press to start grade entry mode.
Down arrow button/Sleep mode button	Press to enter sleep mode. Press to navigate down in the menu. <ul style="list-style-type: none"> • During sleep mode, all functions are disabled. • The LCD screen indicates that the Rugby is in sleep mode. • The Rugby sleeps for 2 hours, then shuts down automatically and must be turned on again at the laser. • When in sleep mode, pressing any button wakes the Rugby and normal operation is resumed.
Smart Target button	Provides access to various special functions. <ul style="list-style-type: none"> • Slope Catch: Allows you to match an existing grade. • Slope Lock: Monitors the grade position to keep the Rugby on grade. • Axis Alignment: Electronically adjusts the axes of the Rugby to your specific grade stakes. • Scan Catch: Searches for the Combo, and once found, produces a 10 ° scan in the direction of the Combo.

Button	Description
Right arrow button/ Volume button	Press to toggle the volume. Press to navigate right in the menu.
	 Press both left and right simultaneously to lock and unlock the keypad and prevent accidental button presses when on the main screen.

4.2

Connecting Screens for the Combo

Information screens while connecting

There are three screens on the Combo which are displayed when connecting to the Rugby.

Searching animation

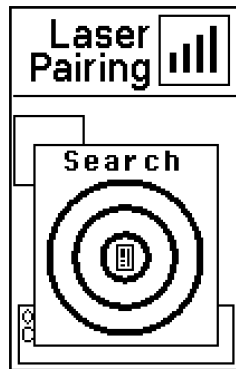

Laser selection screen

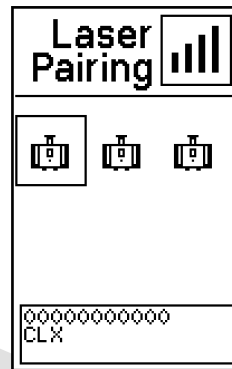

Pairing unsuccessful



Ensure that you are within clear sight of the Rugby and that you have not exceeded the working range.

The amount of discoverable lasers depends on the functionality package installed on the laser that was last paired with the Combo.

4.3

Combo Menu

4.3.1

Access and Navigation

Description

The Combo has several menu options that allow you to optimise the performance of the Rugby for an individual application.

To access the menu of the Combo, press the Up arrow/Menu button while the main screen is displayed.

 The quantity and placement of options shown may not be representative of your product. Features shown depending on the functionality package in operation. Refer to "2.2 Functionality Packages".

Navigation within the Menu:



0016016.001

Keypad of the Combo

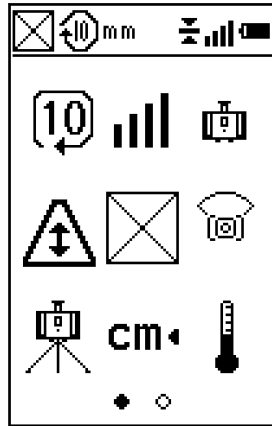

Once in the menu, the buttons Bandwidth, Volume, Sleep and Menu all work according to the shape of the button, rather than the button icon (Up and Down arrow buttons, Left and Right arrow buttons).

Press the Up arrow/Menu button or Down arrow/Sleep mode button to move the cursor and highlight an icon or an option.

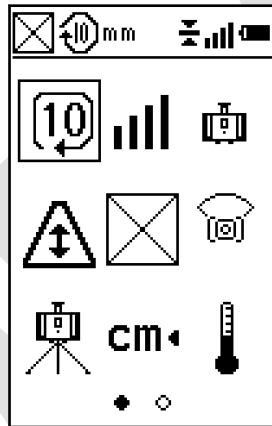

A highlighted icon is surrounded by a box.

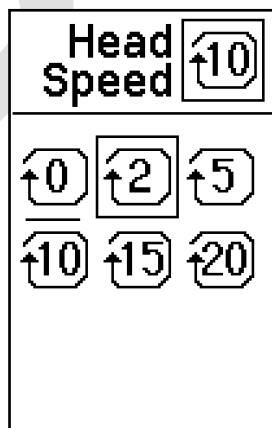

The currently active option is underlined. Press the OK/Grade button to select an icon. To navigate to the second menu page, press Right arrow/Volume button until page two is displayed.

Navigation within the menu without connected or powered on Rugby:

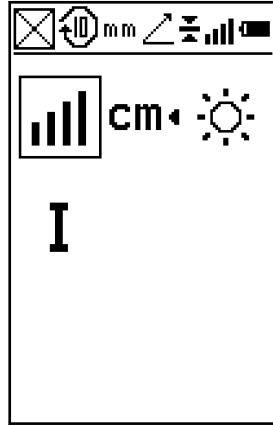

If there is no Rugby paired with the Combo a reduced menu screen is shown. This menu is limited to features that allow for the Combo to be used as a standalone receiver only.

Crossed out icons

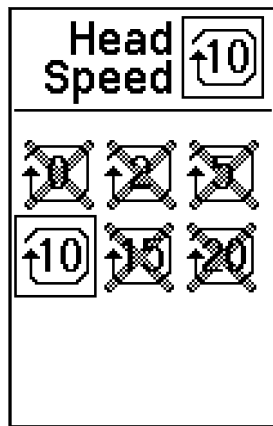

The quantity and placement of options shown may not be representative of your product. Features shown depending on the functionality package in operation. Refer to 2.2 Functionality Packages.

Overview

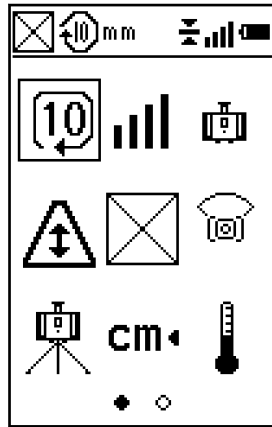

Menu Set 1

In the Menu Set 1, you can select the following options, depending on the functionality package in operation:

- Head speed
- Pairing
- Beam down mode
- H.I.Alert
- Beam masking
- Scanning mode
 - Scanning width
 - Scanning direction
 - Scanning axis
- Sensitivity
- Unit
- Temperature sensitivity



To exit the menu, press the Power/ESC button for a short time.



Press the Right arrow/Volume button until page 2 is displayed to display the Menu Set 2.

Head speed

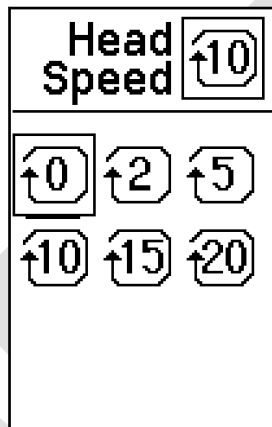

You can select six head speed settings, depending on the functionality package in operation:

- 0 rps
- 2 rps
- 5 rps
- 10 rps
- 15 rps
- 20 rps

Pairing

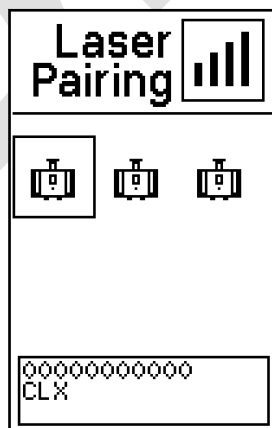

The Rugby and the Combo include radio modules that allow you to activate the functions on the Rugby remotely up to 300 m (1000') away.

☞ With a new Rugby and Combo package, the Rugby and the Combo come pre-paired.

If the Combo has to be paired with one or more Rugby lasers (depending on functionality package in operation), do the following:

1. Turn on the Rugby and the Combo.
2. Enter the menu screen on the Combo.
3. Select the pairing search menu.
The searching process begins.

☞ When the search is successful:
At least one laser icon or maximal five laser icons appear. To establish which the desired laser is, cycle through the icons and observe which laser gives an alert. The laser displays a flashing screen and gives an audio feedback.

☞ When the search is **not** successful:
Either no lasers are found or the desired laser is not available.

4. Press the OK/Grade button to select the laser.

Beam down mode



0016017-001

For layout work, use the Beam down mode to position the beam over a reference point. Then use the Scan mode to move the small scan quickly to a position to the left or right of the laser.

Alternatively, press Beam down to stop the rotating head (0 rps). Refer to 4.3.2 Menu Set 1-Head speed. The position of the beam moves to the downward position to allow for alignment of the Rugby over a reference point on the floor.

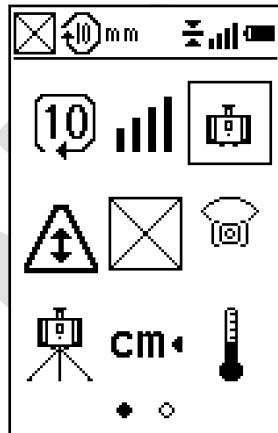

☞ When the Rugby is moved to laydown position the beam down mode is activated automatically.

Beam masking

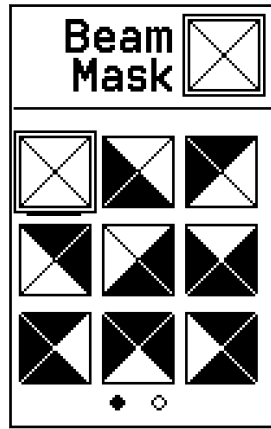

Beam masking screen

Beam masking allows you to turn off the laser beam on selected sides of the laser. It prevents interference with other lasers or receivers that could be working in the same working area.



Additionally, beam masking is useful, when you work in a sensitive environment, close to public eyeline or near reflective surfaces.

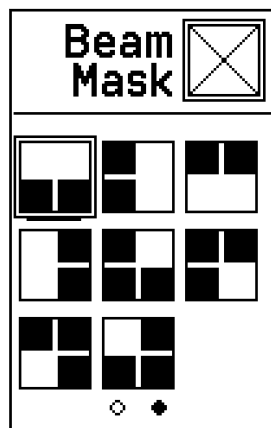

Possible combinations

You can choose to block a quarter, half or three quarters of the rotating laser beam. Each of the four displayed combinations is available in four different variants. The dark area represents the area where the laser beam is turned off. Use the Up arrow/Menu button and Down arrow/Sleep mode button or Left arrow/Bandwidth button and Right arrow/Volume button to choose from the 16 possible combinations over 2 pages.



008451_003

Example

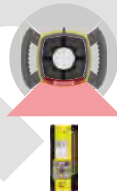

Scanning mode

While a 360 ° range of movement is the default Rugby setting, it is possible to restrict the beam to certain predefined ranges. This Scanning mode can be altered in terms of width, direction and axis. To activate this feature, toggle between 360 ° range and Scanning mode by entering the Scanning mode screen.

Scanning width

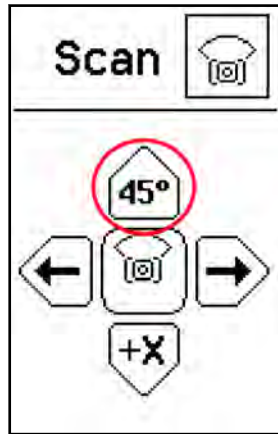

While in Scanning mode, there are three scanning widths available:

- 10 °
- 45 °
- 90 °

Press the Up arrow/Menu button repeatedly to change the scanning widths.

Scanning direction

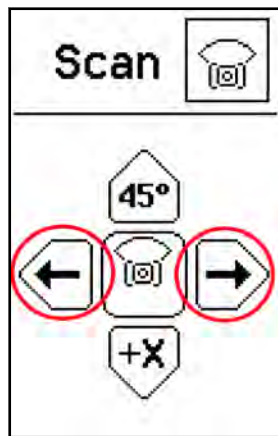

While in Scanning mode, the default direction of the scan is directly in the +X axis. Within the Scanning direction submenu, it is possible to control the direction of the scan manually.

Press the Left arrow/Bandwidth button or Right arrow/Volume button to control the direction.

Scanning axis

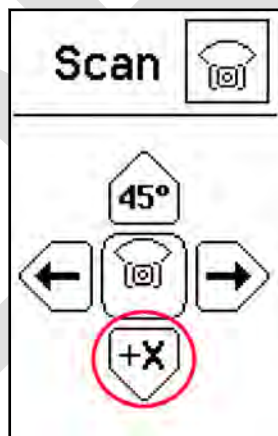

While in Scanning mode, the default direction of the scan is directly in the +X axis. Within the Scanning axis submenu, it is possible to redirect the scan to another axis.

Press the Down arrow/Sleep mode button to toggle between the four axes.

Returning to 360 ° range

Press the OK/Grade button while on the Scanning mode screen to return the Rugby to full 360 ° range.

H.I.Alert - On/Off

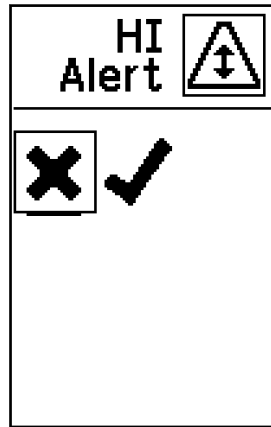

H.I.Alert select

You can choose to enable or disable the H.I.Alert function:

- On
- Off

When enabled, the H.I.Alert function turns on automatically every time the Rugby is turned on. The function becomes active 30 seconds after turning on the Rugby.

How does the H.I.Alert function work

The Height of Instrument (H.I.) or Elevation Alert function prevents incorrect work caused by movement or settling of the tripod that would cause the laser to level at a lower height.

30 seconds after the Rugby has levelled and the head of the laser starts rotating, the H.I.Alert function becomes active.



H.I.Alert activated

The H.I.Alert function monitors the movement of the laser; if disturbed, the H.I.Alert screen flashes and the Rugby beeps rapidly.

To stop the alert, turn the Rugby off and on again. Check the height of the laser before beginning to work again.

Refer to 10 Troubleshooting-Alerts and message screens.



The H.I.Alert function turns on automatically every time the Rugby is turned on.

Sensitivity

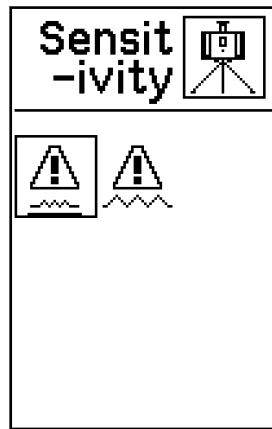

While levelling, the Rugby responds to disturbances, for example wind or vibrations, and stops the head rotation, if necessary. You can choose between two levels of sensitivity:

- Sensitivity Setting 1: For normal performance - wind, vibration and other disturbances are minimal.
- Sensitivity Setting 2: For situations when wind, vibration and other disturbances are more severe.

When enabled, the H.I.Alert function turns on automatically every time the Rugby is turned on. The function becomes active 30 seconds after turning on the Rugby.

Refer to 10 Troubleshooting-Alerts and message screens.

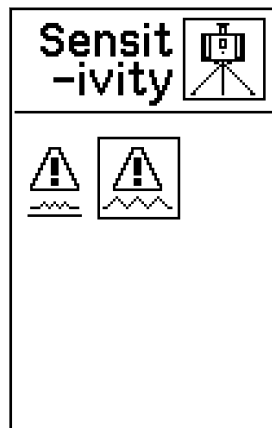

Unit select

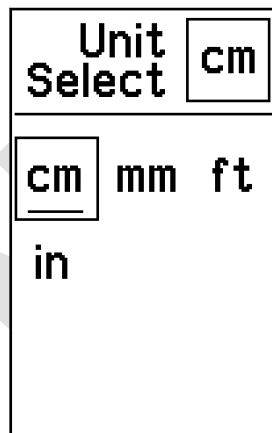

While a beam is being detected on the main screen, the digital read out displays the distance the beam is to the centre point on the Combo. Within the Unit settings menu, it is possible to select the units of the distance measurement:

- cm
- mm
- Inches
- Feet

Temperature sensitivity

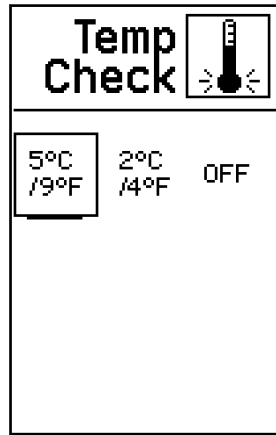

For each change in temperature of $\pm 5^{\circ}\text{C}$ ($\pm 9^{\circ}\text{F}$) the Rugby returns to the level position to check if the change in temperature has led to a change of the main levelling system. For a more sensitive unit, you can change the setting to $\pm 2^{\circ}\text{C}$ ($\pm 4^{\circ}\text{F}$) temperature change.

Alternatively, you can completely disable this feature. As a result, changes in temperature are not monitored for the purposes of the internal levelling system functionality.

Disabling the feature turns off the controlling mechanism.

Available intervals:

- Temperature is checked every $5^{\circ}\text{C}/9^{\circ}\text{F}$
- Temperature is checked every $2^{\circ}\text{C}/4^{\circ}\text{F}$
- Off

Temperature check wait screen

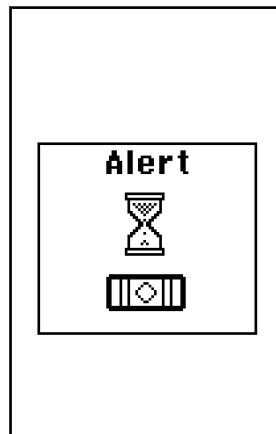

When the Rugby is re-levelling, the Temperature check wait screen is displayed. Wait until the process is finished before using the laser again. The Status LED flashes on the Rugby to indicate normal levelling.

4.3.3

Menu Set 2

Overview

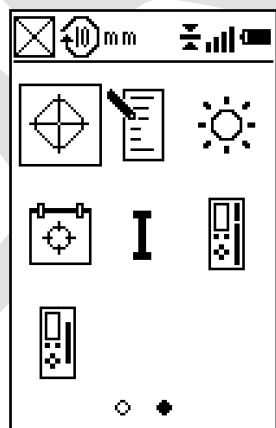

Menu Set 2

In the Menu Set 2, you can select the following parameters, depending on the functionality package in operation:

- Calibration
- Customer name
- Screen contrast
- Calibration alert function
- System info
- Centre line offset
- Combo receiving window modification

To exit the menu, press the Power/ESC button for a short time.

Calibration

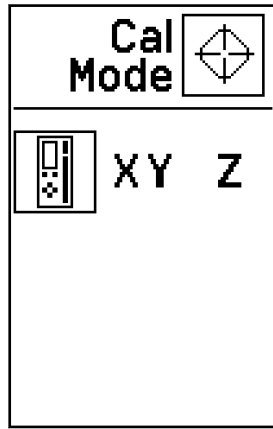

In the calibration menu, you can select the following options:

- Semi-auto calibration. Refer to 9 Semi-Auto-matic Calibration.
- Manual calibration of X & Y. Refer to 8.2 Adjusting the Level Accuracy.
- Manual calibration of Z. Refer to 8.3 Adjusting the Vertical Accuracy.

Customer name

The Customer name setting allows you to enter user details and to enable/disable the Customer name screen when turning on the Rugby.



You can enter 3 lines of text with up to 15 characters per line. The fields are specified as:

- Company
- Town
- Phone Number

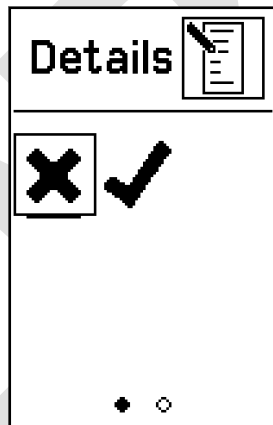

Enable/Disable the Display Name on Start-up

Before entering the name entry, the Display Name on Start-up screen is displayed. Select between two options:

- Display (YES): The Customer name screen is displayed each time the Rugby is turned on.
- Save only (NO): The information entered in the Customer name screen is stored in the laser, but is only visible when the Customer name entry screen is accessed.

Screen contrast

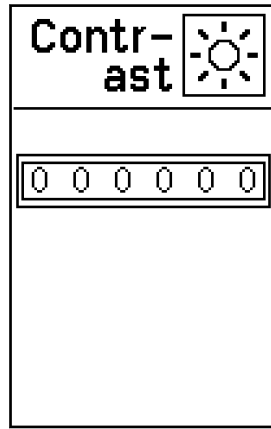

With this setting, you can change the screen contrast of the Combo.

Use the Left arrow/Bandwidth button and Right arrow/Volume button to adjust the contrast.

Calibration alert function

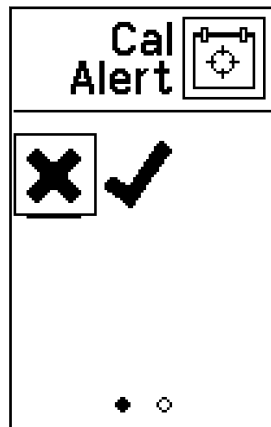

Enable/Disable the calibration alert function

The calibration alert function is based on hours of use.

- ON: Calibration alert is enabled.
- OFF: Calibration alert is disabled.

Calibration alert on Start-up

If you enabled the calibration alert function, the calibration alert hours are displayed on the start-up screen after turning on the Rugby:

Calibration alert hours on Start-up screen

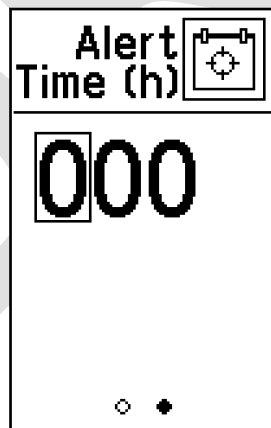

To be alerted of a calibration after X hours of use, enter the desired time before an alert appears.

Calibration alert flashing screen

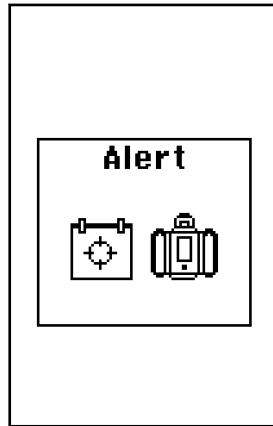

When the number of planned hours is reached, the calibration alert is displayed for 8 seconds. After calibrating the Rugby, the calibration alert hours are automatically reset. Changing or disabling the calibration alert is only possible by accessing the menu option "Calibration alert function".

Centre line offset

The Centre line offset allows you to change the position of the centre line.

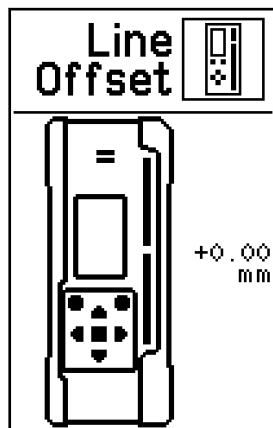

1. Move the Combo so the beam is on the desired centre line position.
2. Press the OK/Grade button to confirm the new centre line position.



Centre line offset is not compatible with Combo receiving window modification.

Combo receiving window modification

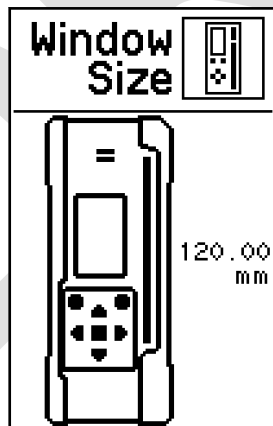

The default height of the Combo window is 120 mm/ 4.72 inches.

The height can be reduced by 50 mm/ 1.97 inches: 25 mm/ 0.98 inches from top and bottom.

1. Press the Up arrow/Menu button and Down arrow/Sleep mode button to modify the window size.
2. Press the OK/Grade button to confirm the new window size.



Combo window modification is not compatible with Centre line offset.

Overview

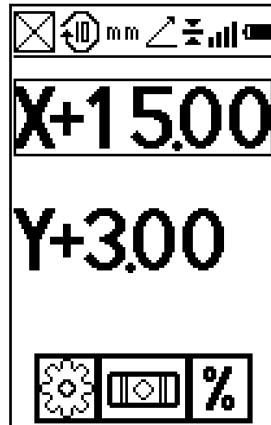

Grade entry screen

In the Grade entry screen you can modify the grade values and select the following parameters:

- Automatic/Manual Mode
- Display - Percent/Per Mil
- Display - Thousandths/Hundredths
- Save Grade Enabled/Disabled
- Negative Grade Enabled/Disabled



To exit the menu, press the Power/ESC button for a short time.

Automatic/Manual mode

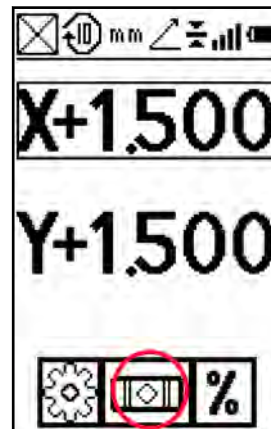

Automatic/Manual mode settings

You can select from three different modes:

- Automatic mode (default)
- Manual mode
- Manual mode with grade



You can choose to disable the automatic self-levelling mode. The Rugby always turns on in automatic mode regardless of the previous selection.

Automatic mode

The Rugby always turns on in automatic mode and continuously self-levels to maintain grade accuracy.

Manual mode

In manual mode the self-levelling function is turned off. The Manual mode screen is displayed instead of the normal main screen.

The plane of laser light can be manually sloped using the same buttons as for direct grade entry, but no value for the grade is shown in the display.

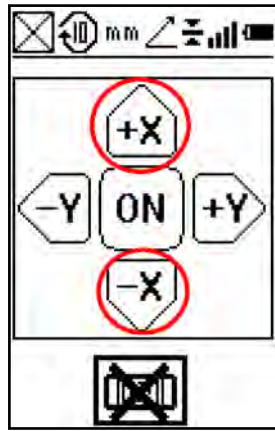

Manual Grade Entry X-Axis

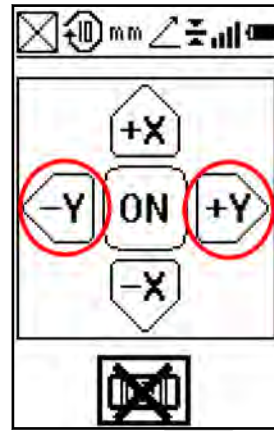

Manual Grade Entry Y-Axis

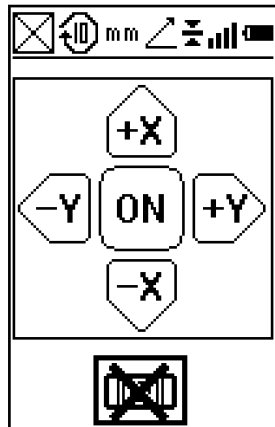

Manual Mode screen

Manual mode with grade

In manual mode with grade the self-levelling function is turned off. The Manual mode with grade screen is displayed instead of the normal main screen.

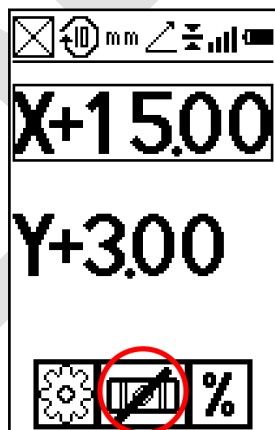

Manual mode with grade X-axis

The plane of laser light can be manually sloped using the same buttons as for direct grade entry. The value of the entered grade is displayed in the Manual Grade Entry screens.

When using this mode, the Rugby first levels to the selected grade, then returns to manual mode.

Display - Percent/Per Mil

You can select to display the grade in percent of grade or per mil:

- 1.000% = 1 metre rise per 100 metres
- 1.00‰ = 1 metre rise per 1000 metres

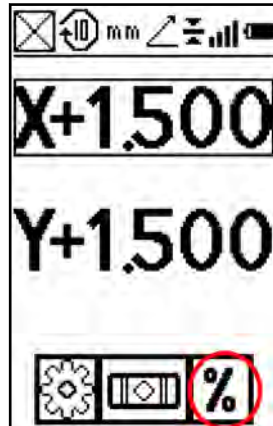

Display Percent

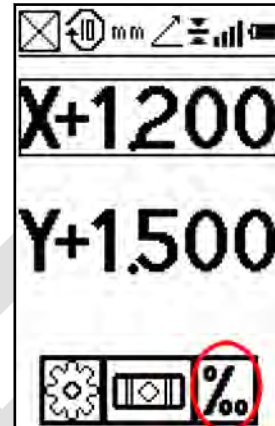

Display per Mil

Standard usage is percent of grade.

Display - thousandths or hundredths

You can select to display percent of grade in thousandths or hundredths:

- .000 - Standard usage is to display thousandths or three digits after the decimal point.
- .00 - If you choose to display hundredths, only two digits are displayed after the decimal point.

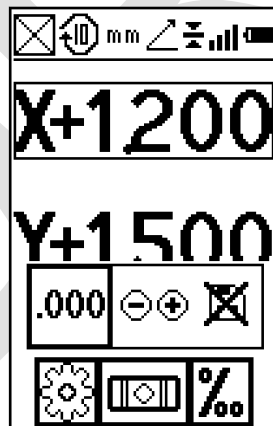

Display thousandths

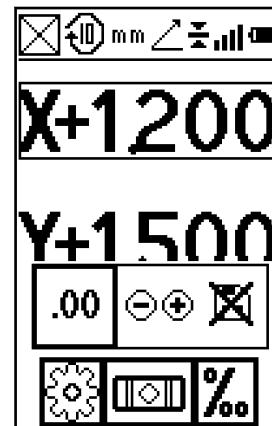

Display hundredths

Save grade

Normally, the grade value is reset to 0.000% every time you turn on the Rugby.

If you prefer to display the previous grade settings when turning on the Rugby, you can enable the option **Save Grade**.

- Show 0.000: The grade settings are reset to 0.000% on power up (default).
- Show Grade: The previous grade settings are displayed on power up.

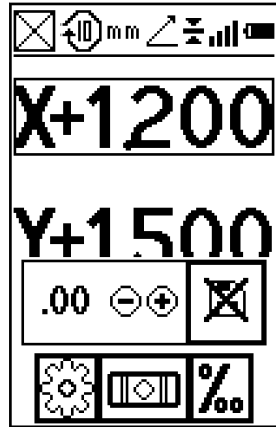

Save grade option disabled

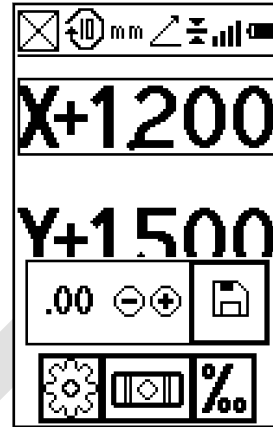

Save grade option enabled

5

The Rod Eye Receivers

5.1

Rod Eye 120, Receiver

Description

The Rugby CLH/CLA/CLI can be sold with the Leica Rod Eye 120 receiver. Additional information on the receiver can be found in the individual User Manuals also on this CD.

Instrument components part 1 of 2

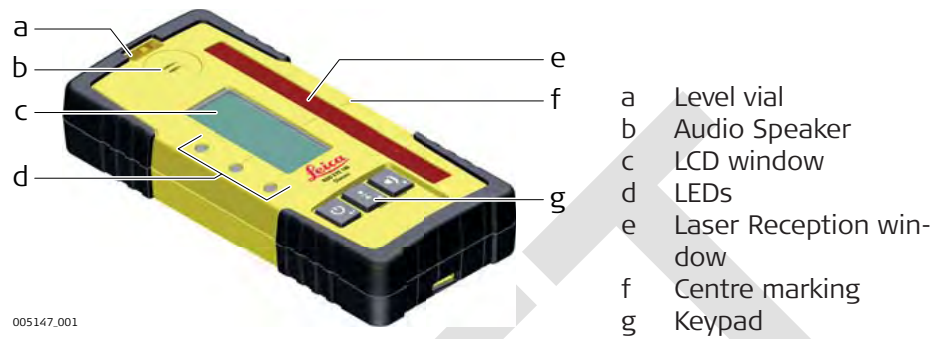

Component	Description
Level vial	Aids to keep the rod plumb when taking readings.
Audio Speaker	Indicates the detector's position: <ul style="list-style-type: none"> • High - Fast beeping • On-grade - Solid tone • Low - Slow beeping
LCD window	Front and rear LCD arrow indicate the detector's position.
LEDs	Display the relative position of the laser beam. Three channel indication: <ul style="list-style-type: none"> • High - Red • On-grade - Green • Low - Blue
Laser reception window	Detects the laser beam. The reception windows must be directed towards the laser.
Centre marking	Indicates the on-grade position of the laser.
Keypad	Power, accuracy and volume functions. Refer to "Description of the buttons" for detailed information.

Instrument components part 2 of 2

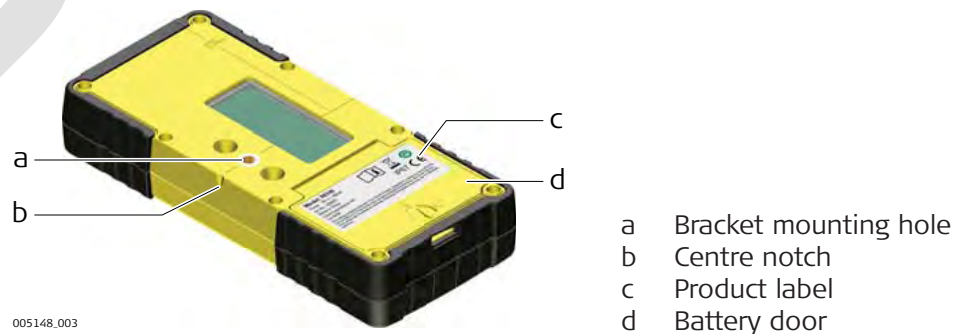

Component	Description
Bracket Mounting Hole	Location to attach the receiver bracket for normal operation.
Centre notch	Use to transfer reference marks. The notch is 85 mm (3.35") below to top of the detector.
Product label	The serial number is located inside the battery compartment.
Battery door	Refer to Chapter "Changing the alkaline batteries step-by-step" in Rod Eye 120 User Manual for detailed information.

Description of the buttons



- a Power
- b Audio
- c Bandwidth

Button	Function
Power	Press once to turn on the receiver.
Audio	Press to change the audio output.
Bandwidth	Press to change detection bandwidth.

Menu access and navigation

To access the menu of the Rod Eye 120 Receiver, press the Bandwidth button and Audio button simultaneously.

- Use the Bandwidth button and Audio button to change parameters.
- Use the Power button to scroll through the menu.

5.2 Rod Eye 140, Classic Receiver

Description

The Rod Eye 140 Classic Receiver provides you with basic position information by using an arrow display.

Instrument components

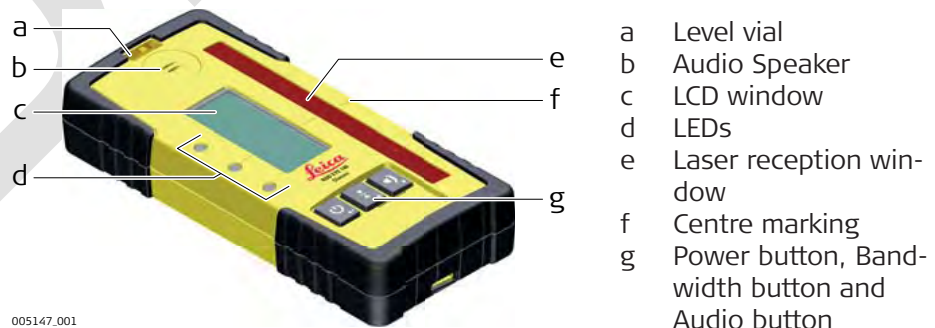

- a Level vial
- b Audio Speaker
- c LCD window
- d LEDs
- e Laser reception window
- f Centre marking
- g Power button, Bandwidth button and Audio button

Description of the buttons



- a Power
- b Audio
- c Bandwidth

Button	Function
Power	Press once to turn on the receiver.
Audio	Press to change the audio output.
Bandwidth	Press to change detection bandwidth.

Menu access and navigation

To access the menu of the Rod Eye 140 Receiver, press the Bandwidth button and Audio button simultaneously.

- Use the Bandwidth button and Audio button to change parameters.
- Use the Power button to scroll through the menu.

5.3

Rod Eye 160, Digital Receiver

Description

The Rod Eye 160 Digital Receiver provides you with basic position information by using an arrow display plus digital readout.

Instrument components



- a Speaker
- b LCD Digital Display
- c LED Display
- d Power button
- e Laser man button
- f Reception window
- g Bandwidth button
- h Audio button

Description of the buttons

Button	Function
Power	Press once to turn on the receiver.
	Press 1.5 seconds to turn off the receiver.
Laser man	Press to capture the digital reading.
Bandwidth	Press to change detection bandwidths.
Audio	Press to change the audio output.

Menu access and navigation

To access the menu of the Rod Eye 160 Digital Receiver, press the Bandwidth button and Audio button simultaneously.

- Use the Bandwidth button and Audio button to change parameters.
- Use the Power button to scroll through the menu.

6 Applications

6.1 Setting Forms

Setting forms step-by-step

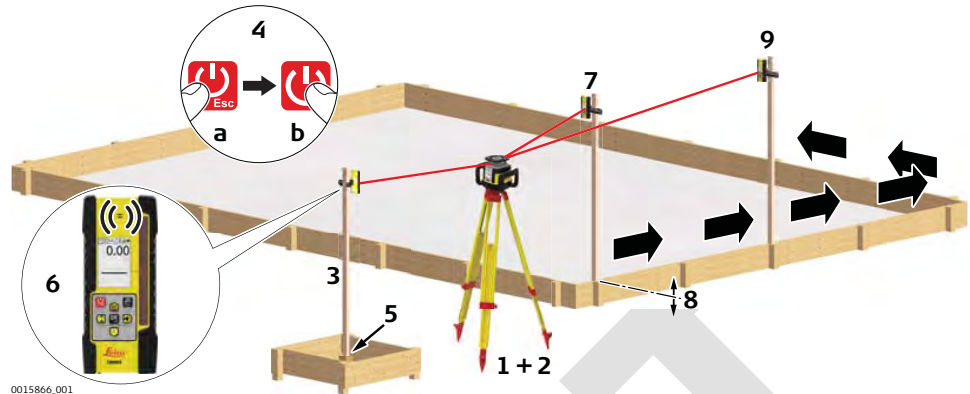

1. Set up the Rugby on a tripod.
2. Set up the tripod on a stable surface outside the working area.
3. Attach the Combo to a rod.
4. Turn on the Rugby and the Combo.
5. Set the base of the rod on a known point for the finished height of forms.
6. Adjust the height of the Combo on the rod until the on-grade (centre-line) position is indicated on the Combo by:
 - the centre bar
 - a solid audio tone
 - the digital display
7. Set the rod with the attached Combo on top of the form.
8. Adjust the height of the form until the on-grade position is again indicated.
9. Continue to additional positions until the forms are levelled to the rotating plane of the Rugby.

6.2 Checking Grades

Availability

Only available for:

- CLX001AG
- CLX20
- CLX200
- CLX250
- CLX30
- CLX300
- CLX40
- CLX400
- CLX50
- CLX500
- CLX60
- CLX600
- CLX70
- CLX700
- CLX80
- CLX800
- CLX90
- CLX900

Checking grades step-by-step

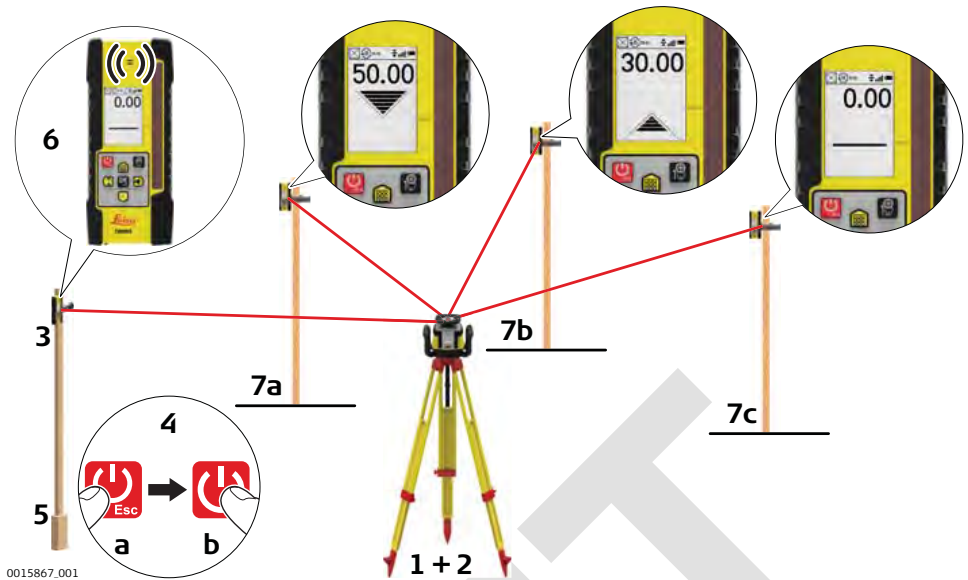

1. Set up the Rugby on a tripod.
2. Set up the tripod on a stable surface outside the working area.
3. Attach the Combo to a rod.
4. Turn on the Rugby and the Combo.
5. Set the base of the rod on a known point for the finished grade.
6. Adjust the height of the Combo on the rod until the on-grade (centre-line) position is indicated on the Combo by:
 - the centre bar
 - a solid audio tone
 - the digital display
7. Set the rod with the attached Combo on top of the excavation or concrete pour to check for correct elevation.
8. Variances can be read in precise measurements with the Combo.
 - 7a: Position is too high.
 - 7b: Position is too low.
 - 7c: Position is on grade.

6.3 Manual Grades

6.3.1 Manual Grades

Manual grades step-by-step

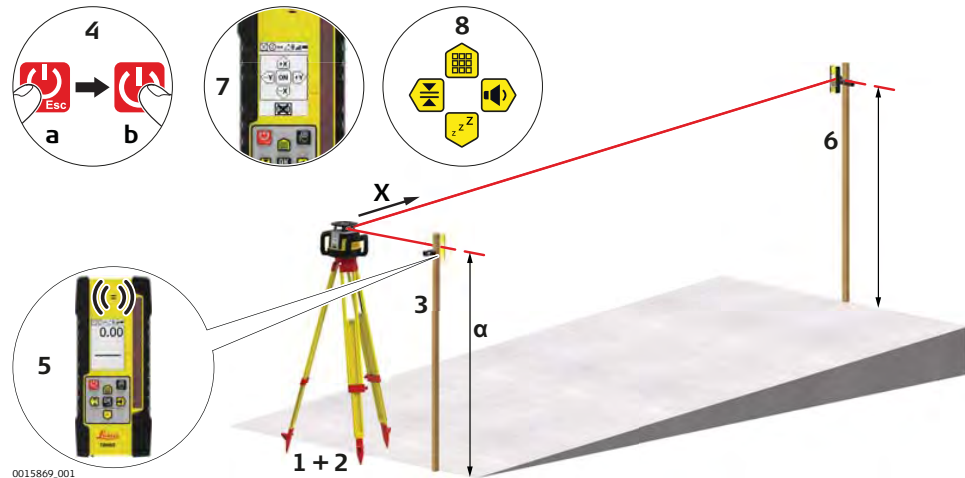



1. Set up the Rugby on a tripod.
2. Set up the tripod at the base of a slope with the x-axis pointing in the direction of the slope.
3. Attach the Combo to a rod.
4. Turn on the Rugby and the Combo.
5. At the base of the slope, adjust the height of the Combo on the rod until the on-grade (centre-line) position is indicated on the Combo by:
 - the centre bar
 - a solid audio tone
 - the digital display
6. Move the rod and the attached Combo to the top of the slope.
7. Change the levelling to Manual mode on the grade screen.
8. Use the Up and Down arrow button on the Rugby to move the laser beam up and down until the on-grade (centre-line) position is indicated on the Combo by:
 - the centre bar
 - a solid audio tone
 - the digital display

6.3.2

Manual Grades with Slope Adapter

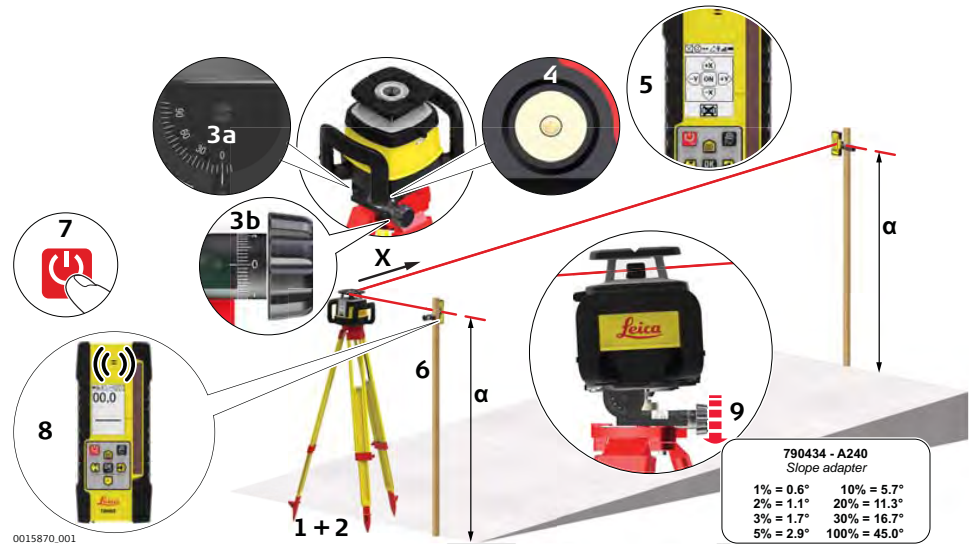
Manual grades with slope adapter step-by-step



1. Set up the Rugby and the slope adapter on a tripod.
 2. Set up the tripod at the base of the slope with the Rugby and the slope adaptor pointing in the direction of the desired slope.
 3. Set the slope adapter to the zero position on the bracket and on the knob.
 4. Roughly level the top of the tripod using the circular level on the slope adapter.
 5. Before entering grade in the slope adapter, start the Rugby in Manual Mode on the grade screen.
 6. Attach the Combo to a rod.
 7. Turn on the Combo.
 8. At the base of the slope, adjust the height of the Combo on the rod until the on-grade (centre-line) position is indicated on the Combo by:
 - the centre bar
 - a solid audio tone
 9. The desired slope can be set with the slope adapter.
-  The Combo can now be used to control the grade of the slope.

6.4

Batter Boards

Description

The Rugby and the Combo create a vertical plane of laser light that acts as a virtual string line for batter board setups.

Laser setup

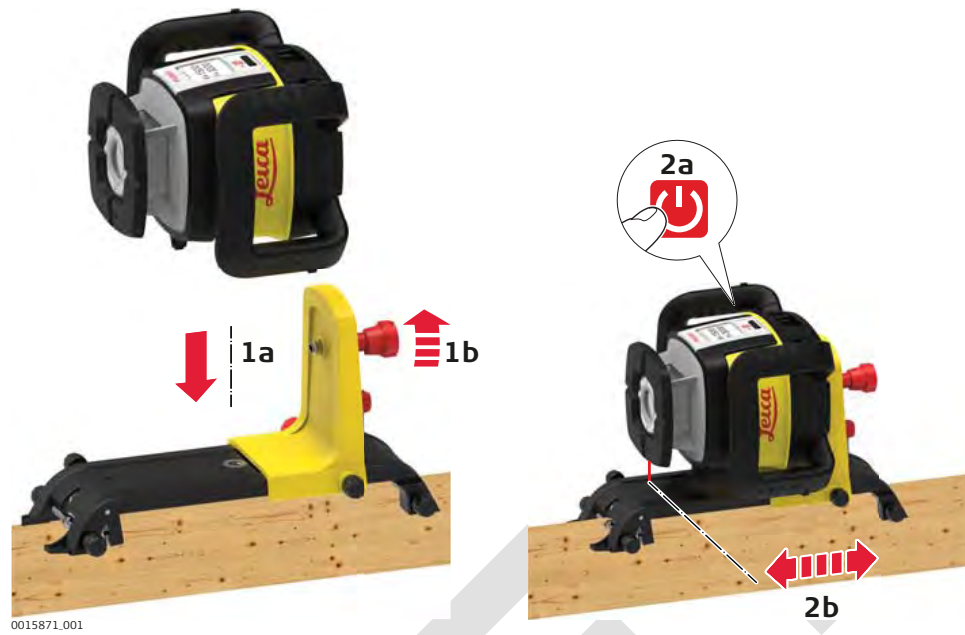

1. Mount the Rugby to the smart adapter and then the smart adapter to the batter board.
2. Turn on the Rugby. The laser beam will automatically point downwards so that the laser and the smart adapter can be positioned directly over the surveyed reference nail.

Combo setup

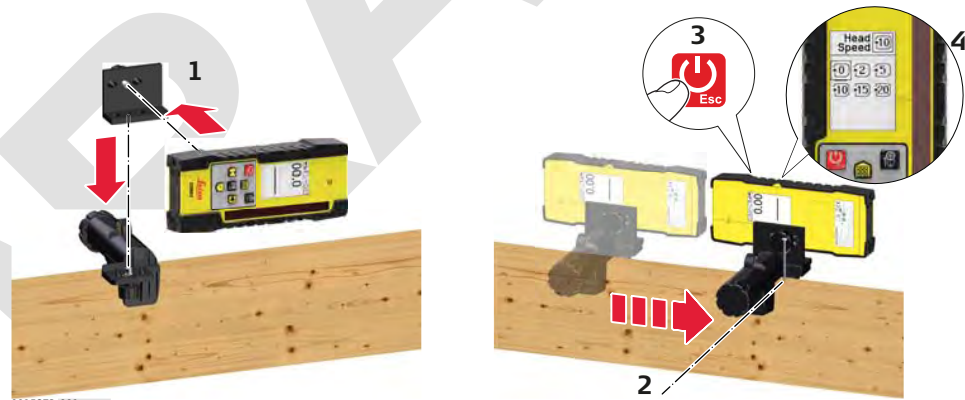

1. Mount the Combo to the Combo bracket using the 90 ° adapter.
2. Attach the bracket to the batter board. The top of the Combo bracket should be tight against the surveyed reference nail.
3. Turn on the Combo.
4. Set the head rotation to the fastest speed. The speed depends on the functionality package in operation.

Alignment

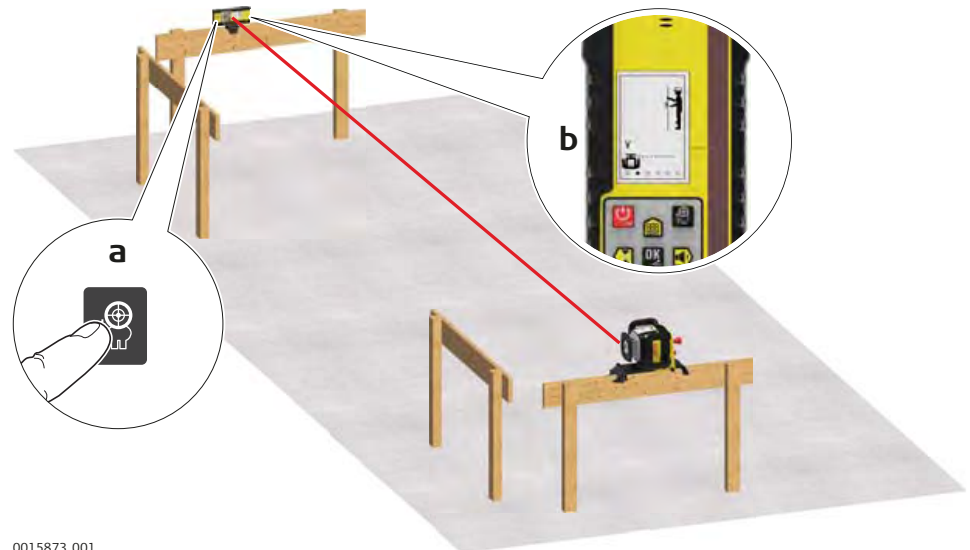

0015873.001

1. Use the Combo to move the rotating laser beam left or right until the Combo displays an on-grade position.

OR

1. Use the Slope Catch function of the Combo to automatically align the vertical rotating plane to the Combo.

2. Press the Smart Target button on the Combo.

3. Navigate to the required process and press the OK/Grade button.

Monitoring



The monitoring process allows for certain position deviations over time. An example of this is the slight positional changes that occur over the course of a day due to temperature fluctuations. Adjustments are made to the Y-axis to ensure the Combo and Rugby maintain the desired grade setting.

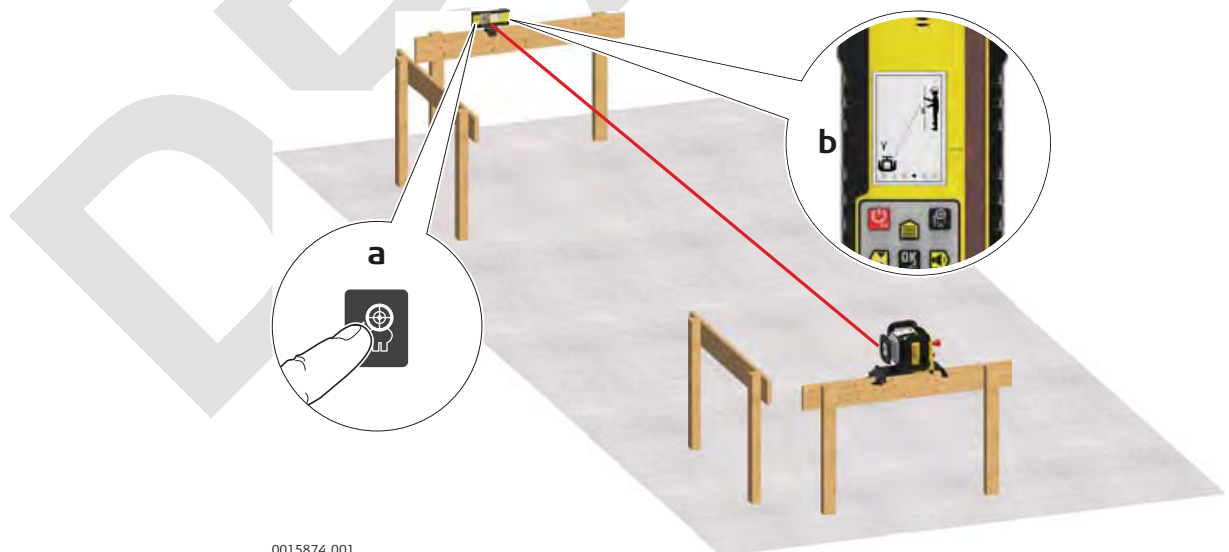

0015874.001

1. Use the Slope Catch function of the Combo to align and then monitor the laser beam automatically.

2. Press the Smart Target button on the Combo.

3. Navigate to the required process and press the OK/Grade button.

 The Combo notifies you when complete.

6.5

Facades

Description

The Rugby and the Combo create a vertical plane of laser light that is aligned to the building and acts as a constant reference for facade installations.

Setup

Mounting the facade adapter brackets



004808_002

1. Mount the facade adapter brackets to the side of the building in locations where it is desired to have a laser and receiver setup.

Laser setup



0015932_001



1. Mount the Rugby to the Smart Adapter and then the Smart Adapter to the facade adapter bracket.
-
2. Turn on the Rugby. The laser beam automatically points downwards so that the laser and the Smart Adapter can be positioned at the desired distance from the surface of the building.

Combo setup

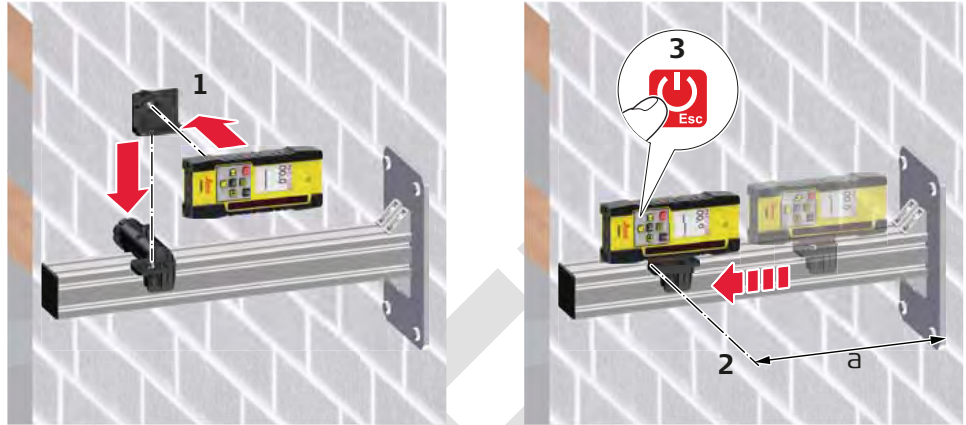

1. Mount the Combo to the receiver bracket using the 90 ° adapter.
-
2. Attach the bracket to the facade adapter bracket. The top of the Combo bracket should be set at the same distance from the surface of the building as the laser for proper alignment.
-
3. Turn on the Combo.
-
4. Set the head rotation to the fastest speed.

Alignment

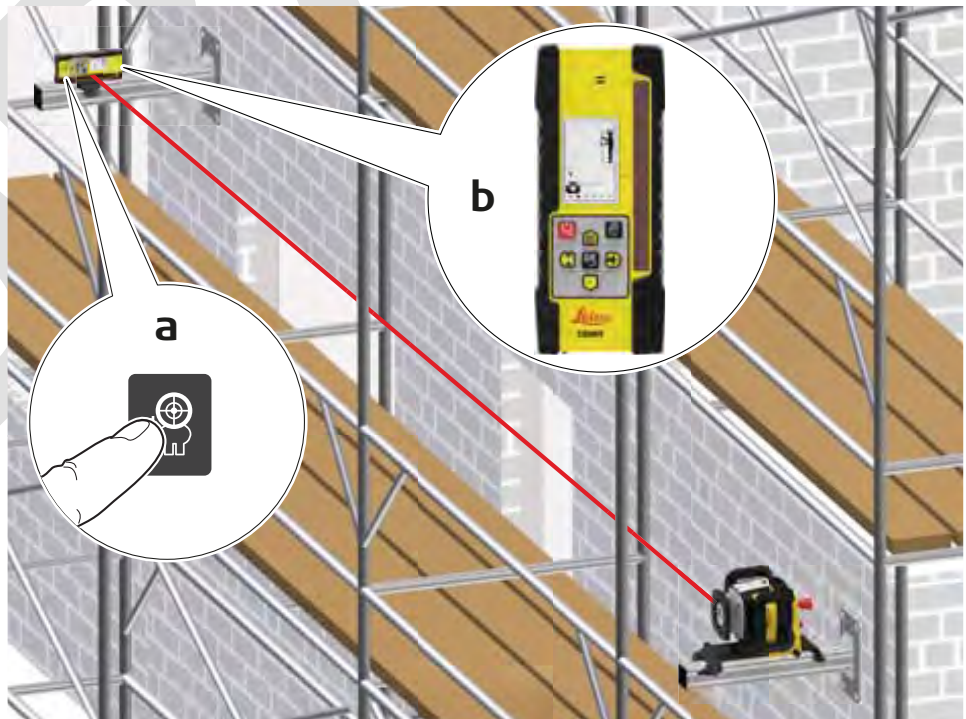

0015934_001

1. Use the Combo to move the rotating laser beam left or right until the Combo displays an on-grade position.
2. Use the Slope Catch function of the Combo to align the vertical rotating plane to the Combo automatically.
3. Press the Smart Target button on the Combo.
4. Navigate to the required process and press the OK/Grade button.

Monitoring

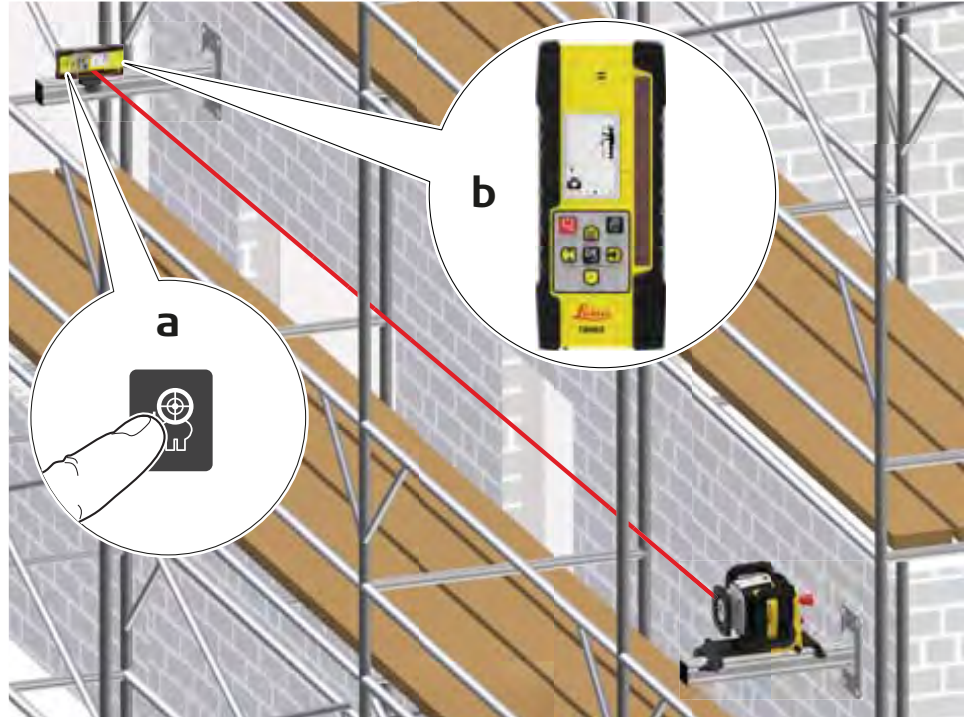

1. Use the Slope Lock function of the Combo to align and then monitor the laser beam automatically.
2. Press the Smart Target button on the Combo.
3. Navigate to the required process and press the OK/Grade button. The Combo notifies you when complete.

6.6

Suspended Ceilings

Description

The Rugby can also be used for suspended ceiling installations.

Mounting the laser



1. Attach the Rugby to the Smart Adapter.

Application

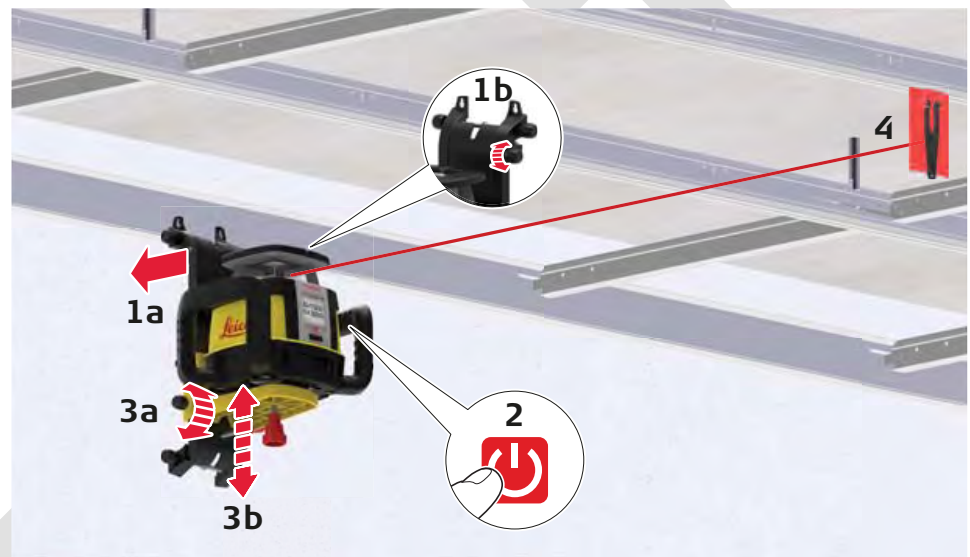

1. After mounting the first strip of ceiling trim at the desired height (centre position of the ceiling target) below, attach the Smart Adapter and laser to the trim. Tighten the locking knobs on the top of the Smart Adapter.
2. Press the Power button to turn on the Rugby and allow the Rugby to self-level.
3. Adjust the Rugby so that the rotating beam is at the desired height below the ceiling grid. Loosen the adjustment knob on the side of the Smart Adapter and slide the Rugby up or down. When at the desired height, tighten the adjustment knob.
4. Install the ceiling grid using the ceiling grid target and laser beam as your reference.

Setup with the Combo

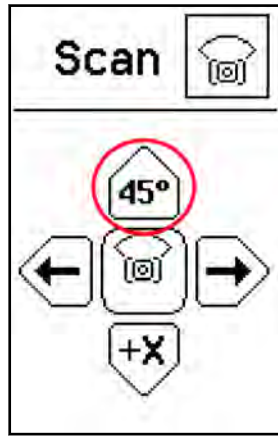

When installing suspended ceilings use the Combo to change to scanning mode for increased visibility.

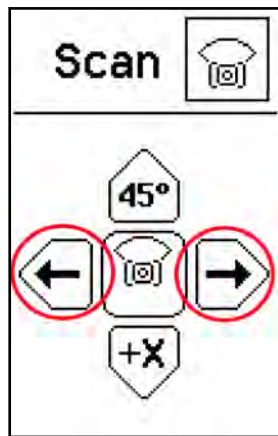

The scanning beam can be rotated using the left and right option on the Combo.

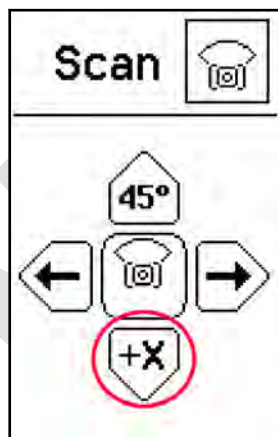

The scanning beam can be moved quickly in 90 ° increments using the Scan 90 ° option.

6.7

Layout

Description

In the laying down position the Rugby can be used for laying out wall positions, squaring, transferring points and more.



Features shown depending on the functionality package in operation. Refer to 2.2 Functionality Packages.

Layout

The Rugby projects two laser beams at a 90 ° angle to each other.

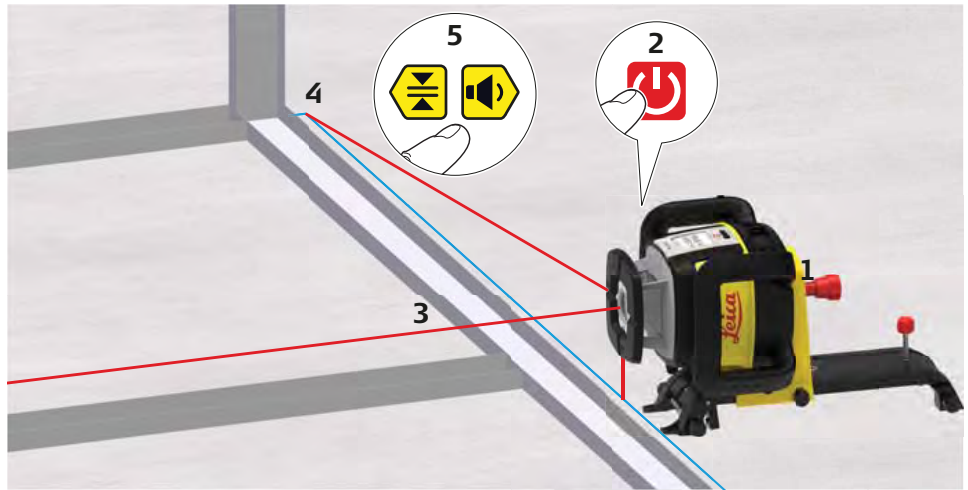

0016023_001

1. Attach the Rugby to the Smart Adapter and place in the laydown position.

2. Press the Power/ESC button to turn on the Rugby. Allow the Rugby to self-level.
 The Rugby will always turn on in Automatic Mode.

3. In the laying down position the laser beam points downwards for alignment over your reference automatically.

4. Start the head rotation or scanning motion to roughly align the beam to a second control point.

5. Enter the grade screen on the Combo by pressing the OK/Grade button. Using the directional buttons on the Combo to fine adjust the beam until striking the second control point.

- Once aligned the split beam and rotating beams can be used to locate 90 ° angles for layout. The rotating beam also creates a vertical plane for transferring points from the floor to the ceiling.

Setup with the Combo

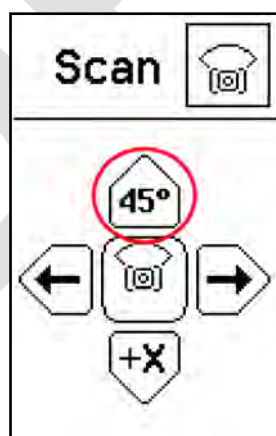

When using the Rugby in the laydown position use the directional buttons on the Combo to align the vertical plane or plumb beam to the second reference point.

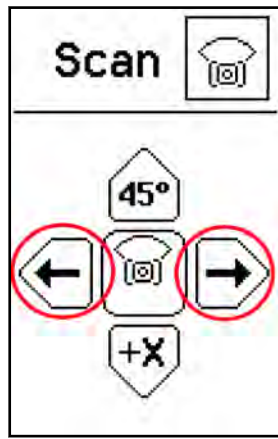

The scanning beam can be moved to the left or right side of the laser using the Scan 90 ° option.

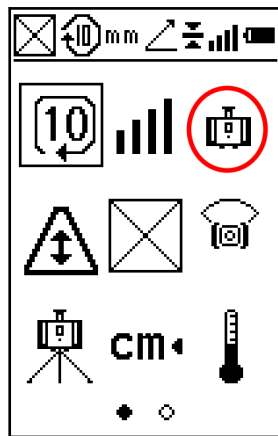

Press the Beam down option to check the alignment over a point.

6.8

Layout with Slope Catch



Features shown depending on the functionality package in operation. Refer to 2.2 Functionality Packages.

Layout with Slope Catch

The Rugby projects two laser beams at a 90 ° angle to each other.

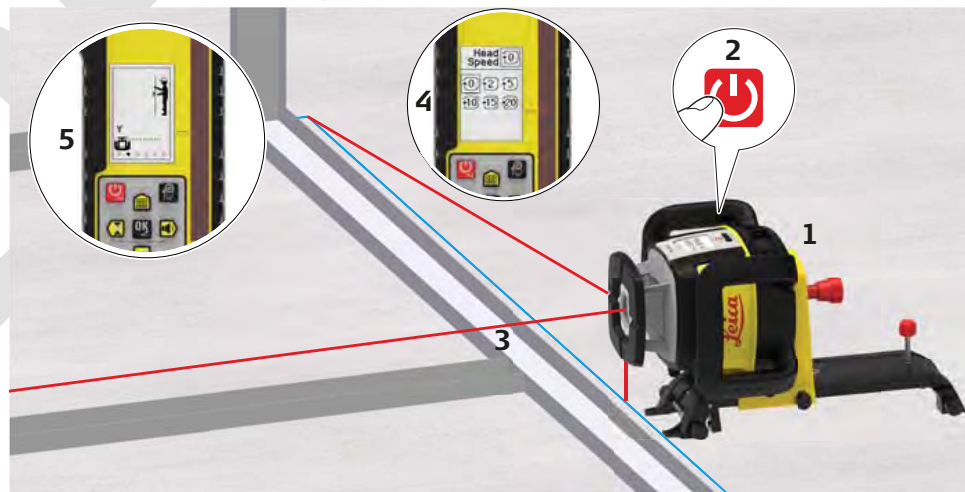

0016025_001

1. Attach the Rugby to the Smart Adapter and place in the laydown position.

2. Press the Power button to turn on the Rugby. Allow the Rugby to self-level.
 ☞ The Rugby will always turn on in Automatic Mode.

3. In the laying down position the laser beam points downwards for alignment over your reference automatically.

4. Start the head rotation or scanning motion to roughly align the beam to a second control point.

5. Press the Smart Target button, navigate to the Slope Catch feature and press the OK/Grade button.
 ☞ When the Slope Catch process is complete, the Combo alerts you.

- ☞ Once aligned the split beam and rotating beams can be used to locate 90 ° angles for layout. The rotating beam also creates a vertical plane for transferring points from the floor to the ceiling.

Setup with the Combo

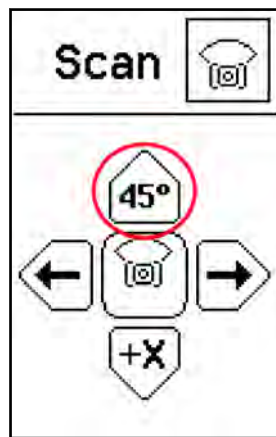

When using the Rugby in the laydown position use the directional buttons on the Combo to align the vertical plane or plumb beam to the second reference point.

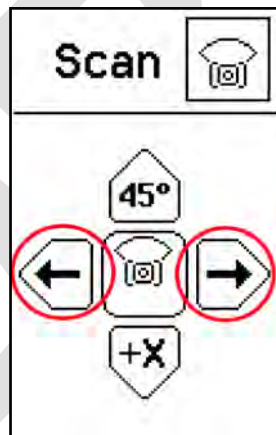

The scanning beam can be moved to the left or right side of the laser using the Scan 90 ° option.

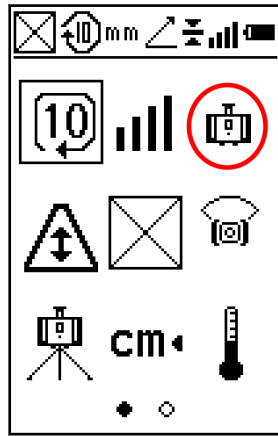

Press the Beam down option to check the alignment over a point.

6.9

Grade Dial-in

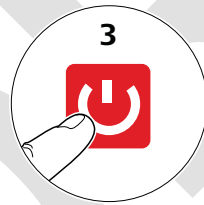
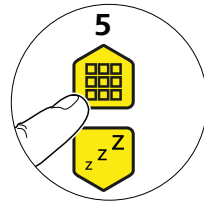

Grade dial-in step-by-step

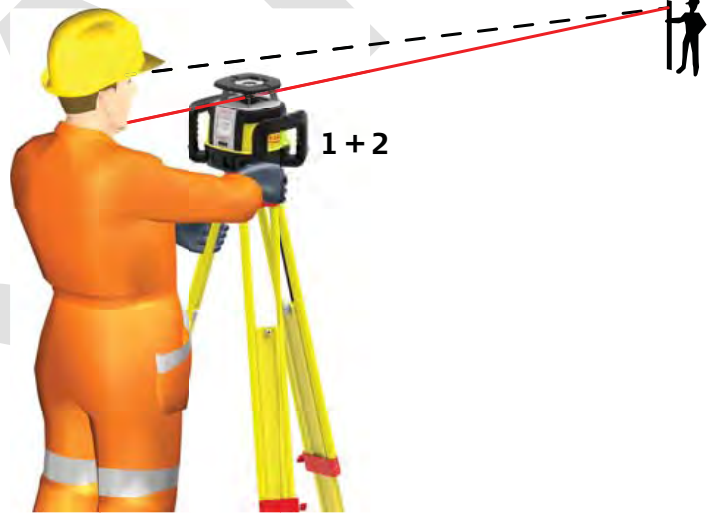
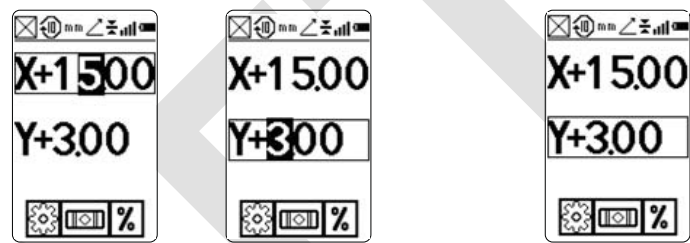

0015875.001



1. Set up the Rugby on a tripod.
2. Set up the Rugby and the tripod in line with one axis of the job and align the top of the Rugby in the direction of the axis.
3. Turn on the Rugby.
4. Press the OK/Grade button.
5. Press the Up arrow/Menu button or Down arrow/Sleep mode button to select an axis. Press the OK/Grade button to confirm your selection.
6. Press the Up arrow/Menu button or Down arrow/Sleep mode button to edit a selected character. Press the Left arrow/Bandwidth button and Right arrow/Volume button to navigate the characters.

7. Once grade is entered, the Rugby begins to adjust to grade. Do not disturb the Rugby during this process.
 -  The values flash while the levelling is in process.
-  Press the Up arrow/Menu button and Down arrow/Sleep mode button simultaneously to reset the grade value to zero while in grade entry mode.

6.10

Smart Target (Slope Catch)

Slope Catch step-by-step using the Combo

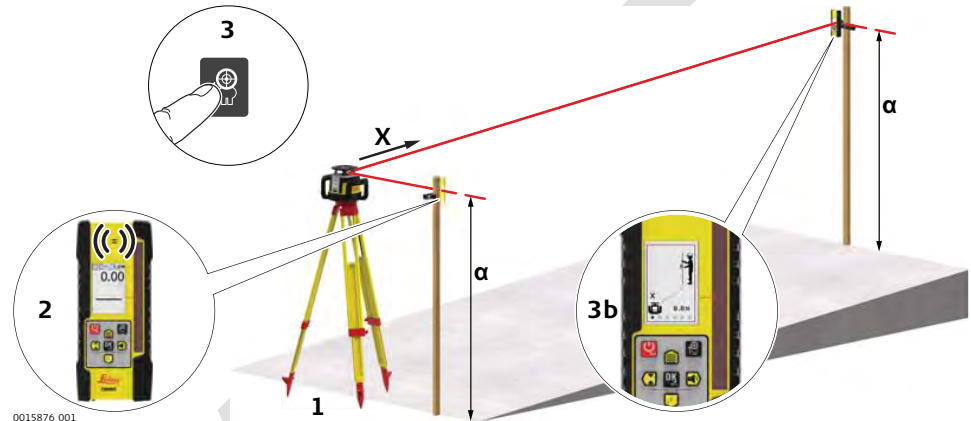

Using the Slope Catch feature you can match an existing grade. The Rugby moves to the new grade position, displays the grade found and begins self-levelling to maintain the grade over time. Maximum range is 100 m (300').



1. Set up the Rugby at the base of a slope with no grade dialled into the Rugby and with the X-axis pointing in the direction of the slope.
2. Adjust the height of the Combo on the rod at the base of the slope until the on-grade (centreline) position is indicated on the Combo by:
 - the centre bar
 - a solid audio tone
 - the digital display
3. Move the rod with the Combo to the top of the slope. To start the Slope Catch process, press the Smart Target button and select the first option.

The Rugby searches for the Combo until the on-grade position is found. Once the on-grade position is found, the Combo screen displays a tick and the Combo returns to normal operation.

4. After this signal, the receiver can be moved and used as normal. The grade for the sloped axis is displayed on the screen and the Rugby now self-levels to this new slope.

-  To use Slope Catch for the Y-axis, press the Smart Target button and choose the second option. The process is identical.
-  You can set up either one or both axes by using this procedure.

6.11

Smart Target (Slope Lock)

Slope Lock step-by-step using Combo

Using the Slope Lock feature, you can match an existing grade. The Rugby moves to the new grade position, displays the grade found and begins self-levelling to maintain the grade over time. Maximum range is 100 m (300').

Press the Smart Target button and select option 3 or 4 to begin the lock mode. The Combo must remain in place to monitor any movements of the rotating beam. Thus, an accurate grade setup is maintained.

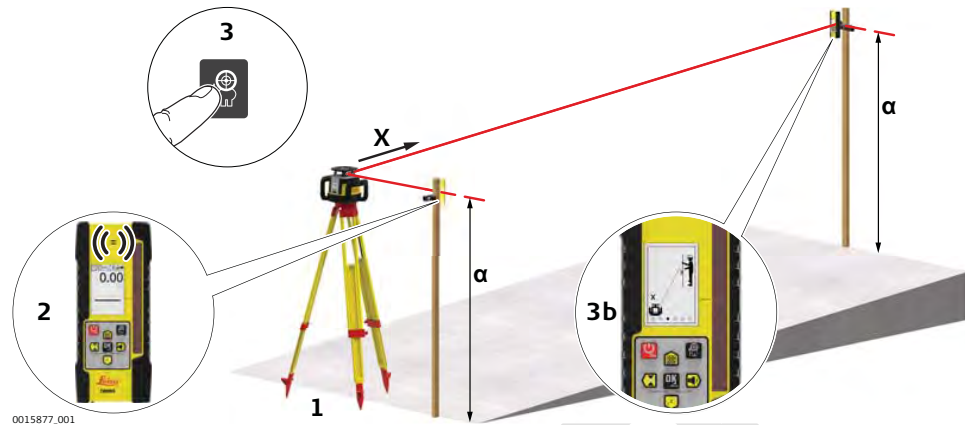

1. Ensure that the grade value is set to zero. Set up the Rugby at the base of a slope with the X-axis pointing in the direction of the slope.

2. At the base of the slope, adjust the height of the Combo on the rod until the on-grade (centreline) position is indicated on the Combo by:
 - the centre bar
 - a solid audio tone
 - the digital display

3. Press the Smart Target button and select option 3 to begin the lock mode X-axis slope catching and lock process.

The Rugby searches for the Combo until the on-grade position is found. Once the on-grade position is found, the Combo displays a tick on the screen.

4. After this signal, the Combo must remain in place to monitor any movements of the rotating beam. The grade for the sloped axis is displayed on the screen of the Rugby.
 - ☞ To use Slope Lock for the Y-axis, press the Smart Target button and select option 4. The process is identical.
 - ☞ Using this procedure, you can set up either one or both axes.
 - ☞ To turn off lock mode on the Combo, hold the Power/ESC button for 1.5 seconds.
 - ☞ To lock and monitor the rotating beam of an existing grade, mount the Combo in the plane of the laser before starting the Slope Lock procedure.

6.12

Automatic Axis Alignment

Description

The automatic axis alignment electronically adjusts the axes of the Rugby to your grade stakes. The procedure is the same as the procedure described in "3.8 Precise Alignment of the Axes" - except that the alignment is done electronically, using the Combo.

For the automatic axis alignment, it is only necessary to position the laser and Combo in line with two grade stakes and to start the procedure. The following steps are done automatically:

- The Rugby searches for the Combo on the Y-axis until it is found and locked on grade.
- Once found, the Rugby drives grade into the X-axis and monitors the position of the beam on the Combo.

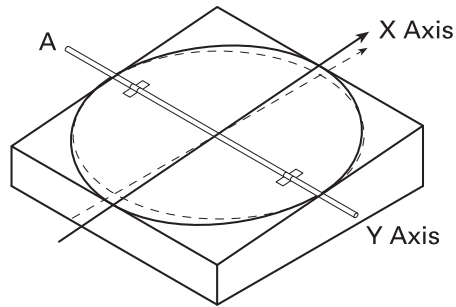

- The Rugby electronically compensates for any misalignment by adjusting the beam until it is again locked on the Combo.
- The procedure is then complete and the Rugby returns to the grades that you entered. The laser is now properly aligned.

Automatic axis alignment step-by-step

1. Dial in the required grade for the X- and Y-axis.
2. Position the Rugby at Point A in line with the Y-axis. Alternatively, the laser can also be aligned to the X-axis.
3. Roughly align the Y-axis using the alignment marks on top of the Rugby.
Position the Combo also in line with the Y-axis. The height of the Combo is not important for this procedure. Maximum range is 100 m (300').
4. To start the automatic alignment of the Y-axis, press the Smart Target button on the Combo and select option 2.
The Rugby starts searching for the Combo. The Combo displays AAY (Axis Alignment Y-axis) during the alignment procedure.
The automatic alignment procedure takes approximately 2 minutes.
☞ Ensure that the Combo is held steady until the procedure is complete!
5. If the procedure is successful:
The Combo displays a tick icon one second, then returns to normal operation.
If the procedure is **not** successful:
The Combo displays a cross icon for 5 seconds, then turns off.

Information screens during alignment procedure

During and after the alignment procedure the Rugby displays information screens to indicate the status of the procedure. During the alignment procedure, the WAIT screen is displayed.

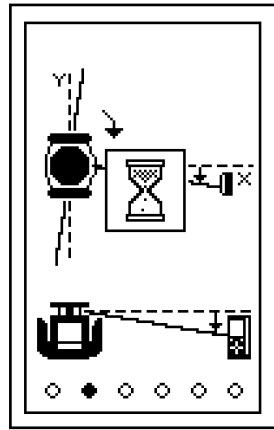

When the alignment procedure is successful, the Rugby displays the COMPLETE screen for 8 seconds, then resumes normal operation.

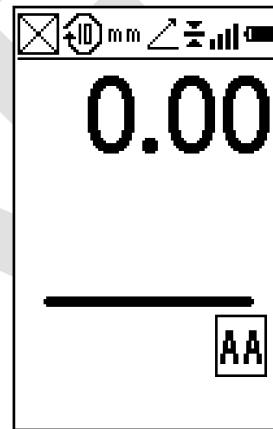
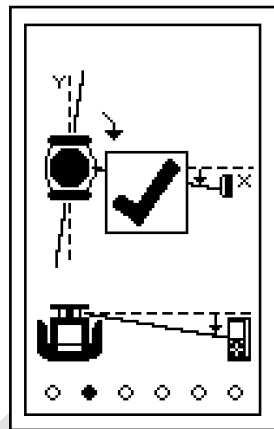

If the alignment procedure is not successful, the Rugby displays the ERROR screen for up to 2 minutes, then shuts down.

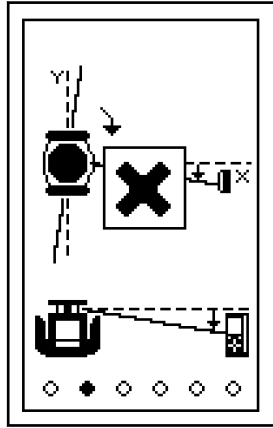

6.13

Axis Alignment plus Slope Lock

Axis Alignment plus Slope Lock

If you also want the Combo to monitor the beam after the axis alignment, you have to place the Combo's on grade position exactly in the plane of the laser and start the Slope Lock process.

Refer to 6.11 Smart Target (Slope Lock).

6.14

Dual Receiver Setups

Dual Receiver setups using the Rugby CLH/CLA/CLI

It is possible to use the Smart Target features of the Combo to catch and lock both axes of the laser. To do this, perform the actions above for the first axis, and then repeat the actions for the second axis using a second Combo.

☞ Once the Slope Lock process is started, the receivers must remain in place.

More applications

Exterior Applications

- Setting elevation of forms and footings
- Squaring of forms
- Checking elevations and benchmarks
- Landscaping
- Drainage and septic systems
- Fences and retaining walls
- Decks and patios
- Simple driveways or small parking lots
- Facade Installations
- Batter board setups
- Road levelling
- Rail levelling
- Land levelling

Interior Applications

- Suspended ceilings
 - Walls and partitions
 - Vertical alignment
 - Transferring points from floor to ceiling
 - Vertical plumb
 - Layout of floors
 - Squaring of angles
 - Setting cabinets
 - Chair rails and wainscoting
 - Alignment of wall and floor tiles
 - Trim carpentry
 - Setting sprinkler head heights
 - Sloped ceilings
-

DRAFT

Description

The Rugby CLH/CLA/CLI and Combo can only be purchased with a rechargeable Li-Ion battery pack.

The following information is appropriate only to the model you have purchased.



The following advice is only valid for battery charger, power adapter and car adapter.

 WARNING
Unauthorised opening of the product

Either of the following actions may cause you to receive an electric shock:

- Touching live components
- Using the product after incorrect attempts were made to carry out repairs

Precautions:

- ▶ Do not open the product!
- ▶ Only Leica Geosystems authorised service centres are entitled to repair these products.



The following advice is only valid for batteries, power adapter or docking station.

 WARNING
Electric shock due to use under wet and severe conditions

If unit becomes wet it may cause you to receive an electric shock.

Precautions:

- ▶ If the product becomes humid, it must not be used!
- ▶ Use the product only in dry environments, for example in buildings or vehicles.



- ▶ Protect the product against humidity.

7.1

First-time use/ charging batteries

Operating Principles

- The battery must be charged before using it for the first time because it is delivered with an energy content as low as possible.
- The permissible temperature range for charging is from 0 °C to +40 °C/ +32 °F to +104 °F. For optimal charging, we recommend charging the batteries at a low ambient temperature of +10 °C to +20 °C/+50 °F to +68 °F if possible.
- It is normal for the battery to become warm during charging. Using the chargers recommended by Leica Geosystems, it is not possible to charge the battery once the temperature is too high.
- For new batteries or batteries that have been stored for a long time (> three months), it is effectual to make only one charge/discharge cycle.
- For Li-Ion batteries, a single discharging and charging cycle is sufficient. We recommend carrying out the process when the battery capacity indicated on the charger or on a Leica Geosystems product deviates significantly from the actual battery capacity available.

Operation/ discharging

- The batteries can be operated from -20 °C to +55 °C/-4 °F to +131 °F.
- Low operating temperatures reduce the capacity that can be drawn; high operating temperatures reduce the service life of the battery.

7.2

Charging the Li-Ion battery pack step-by- step

Battery for Rugby

The rechargeable Li-Ion battery pack on the Rugby can be charged without removing the battery pack from the laser.



1. Slide the locking mechanism on the battery compartment to the left to expose the charge jack.
2. Plug the AC connector into the appropriate AC power source.
3. Connect the charger plug into the charge jack on the Rugby battery pack.
4. The small LED next to the charge jack flashes indicating that the Rugby is charging. The LED is on solid when the battery pack is fully charged.
5. When the battery pack is fully charged, disconnect the charger plug from the charge jack.

6. Slide the locking mechanism to the centre position to prevent dirt from getting into the charging jack.



The battery pack reaches a full charge in approximately 5 hours if completely empty. A one-hour charge should allow the Rugby to run for a full 8 hours.

Changing the Li-Ion batteries step-by-step

With the rechargeable Li-Ion battery pack the battery indicator on the Rugby LCD display shows when the battery pack is low and needs to be charged. The charge indicator LED on the Li-Ion battery pack indicates when the pack is being charged (flashing slowly) or fully charged (on, not flashing).



0015878_001



The batteries are inserted in the front of the laser.



The rechargeable battery pack can be recharged without being removed from the laser. Refer to 7.2 Battery for Rugby-Charging the Li-Ion battery pack step-by-step.

1. Slide the locking mechanism on the battery compartment to the right and open the cover of the battery compartment.
2. To remove the batteries: Remove the batteries from the battery compartment.
To insert the batteries: Insert the batteries into the battery compartment.
3. Close the cover of the battery compartment and slide the locking mechanism to the left centre position until it locks into position.

7.3

Battery for Combo

Charging the Li-Ion battery step-by-step

Charging with charger A100



0016071.001

 Only use the charger delivered with the Rugby/Combo package.

1. Open the cover to expose the charge jack.
2. Plug the AC connector into the appropriate AC power source.
3. Connect the charger plug into the charge jack.
4. When the battery pack is fully charged, disconnect the charger plug from the charge jack.
5. Close the cover to prevent dirt from getting into the charging jack.

Charging with power bank

1. Open the cover to expose the USB-C port.
2. Plug the USB cable into the power bank.
3. Connect the USB plug into the USB-C port.
4. When the battery pack is fully charged, disconnect the USB plug from the USB-C port.
5. Close the cover to prevent dirt from getting into the USB-C port.

8

Accuracy Adjustment

About

- It is the responsibility of the user to follow operating instructions and to periodically check the accuracy of the laser and work as it progresses.
- The Rugby is adjusted to the defined accuracy specification at the factory. It is recommended to check the laser for accuracy upon receipt and periodically thereafter to ensure accuracy is maintained. If the laser requires adjustment, contact your nearest authorised service centre or adjust the laser using the procedures described in this chapter.
- Only enter the accuracy adjustment mode when you plan to change the accuracy. Accuracy adjustments should only be performed by a qualified individual that understands basic adjustment principles.
- It is recommended to perform this procedure with two people on a relatively flat surface.

8.1

Checking the Level Accuracy

Checking the level accuracy step-by-step

1. Place the Rugby on a flat, level surface or tripod approximately 30 m (100 ft) from a wall.

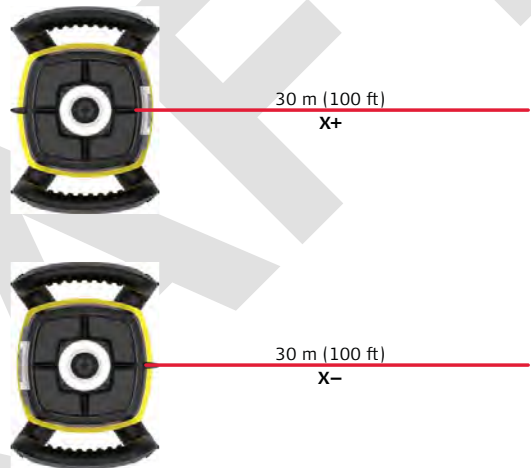

2. Align the first axis so that it is square to a wall. Allow the Rugby to self-level completely (approximately 1 minute after the Rugby begins to rotate).
3. Mark the position of the beam.
4. Rotate the laser 180° and allow it to self-level.
5. Mark the opposite side of the first axis.

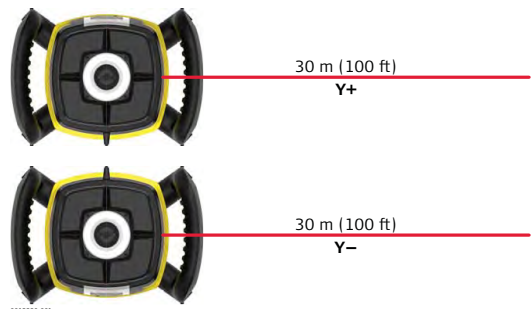

6. Align the second axis of the Rugby by rotating it 90° so that this axis is square to the wall. Allow the Rugby to self-level completely.

7. Mark the position of the beam.
 8. Rotate the laser 180° and allow it to self-level.
 9. Mark the opposite side of the second axis.
-  The Rugby is within its accuracy specification if the four marks are within ± 1.5 mm ($\pm 1/16$ ") from the centre.

8.2 Adjusting the Level Accuracy

Description

In Calibration mode the X-axis calibration screen indicates changes to the X-axis.

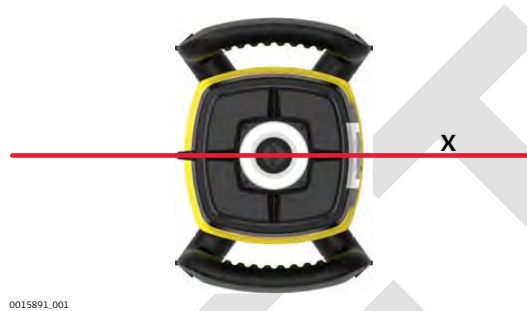

0015891.001

The Y-axis calibration screen indicates changes to the Y-axis.



0015892.001

Entering calibration mode step-by-step

1. Enter the calibration menu.
2. Select the axis you want to calibrate.
3. Modify the values as appropriate.

 In Calibration mode, the LED does not blink and the laser head continues to rotate. An hour-glass indicates that the Rugby is levelling.

Calibrating the X-axis step-by-step

When entering Calibration mode, the X-axis calibration screen appears:

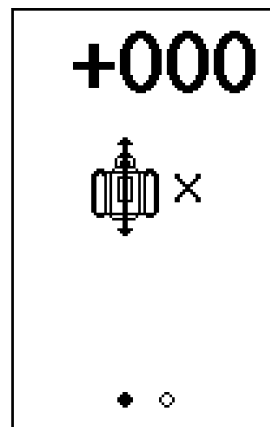

1. When the hour glass has disappeared, indicating that the Rugby has levelled, check both sides of the X-axis.

2. Press the Up arrow/Menu button and Down arrow/Sleep mode button to bring the plane of laser light to the specified level position.
 - ☞ Each step represents approximately 2 arc seconds of change. Therefore, 5 steps equal approximately 1.5 mm at 30 m (1/16" at 100').

3. Press the OK/Grade button to accept the adjusted position and to switch to the Y-axis calibration screen.

Calibrating the Y-axis step-by-step

After calibration of the X-axis, the Y-axis calibration screen appears:

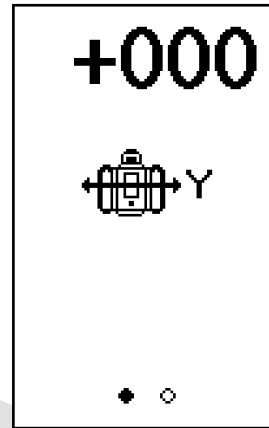

1. When the hour glass has disappeared, indicating that the Rugby has levelled, check both sides of the Y-axis.

2. Press the Up arrow/Menu button and Down arrow/Sleep mode button to bring the plane of laser light to the specified level position.
 - ☞ Each step represents approximately 2 arc seconds of change. Therefore, 5 steps equal approximately 1.5 mm at 30 m (1/16" at 100').

3. Press the OK/Grade button to accept the adjusted position and exit the calibration screen.

Exiting calibration mode

Press the OK/Grade button to accept the adjusted position and exit the calibration screen.



Press the Power/ESC button quickly at any time while in calibration mode to exit the mode without saving changes.

8.3 Adjusting the Vertical Accuracy

Entering calibration mode for the Z-axis step-by-step

1. Enter the calibration menu.

2. Put the Rugby in laydown position.

3. Select the axis you want to calibrate.

4. Modify the values as appropriate.



In Calibration mode, the LED does not blink and the laser head continues to rotate. An hour-glass indicates that the Rugby is levelling.

Calibrating the Z-axis step-by-step

When entering calibration mode for the Z-axis, the Z-axis calibration screen appears:



0016017.001

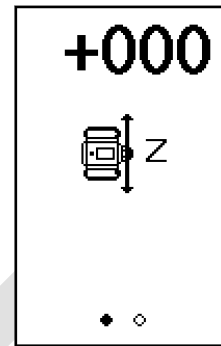

Rugby laying down position

Combo Z-axis calibration screen

1. Press the Up arrow/Menu button and Down arrow/Sleep mode button to increment the vertical position of the laser beam.
2. Continue to press the Left arrow/Bandwidth button and Right arrow/Volume button and monitor the beam until the Rugby is within its specified range.
3. Press the OK/Grade button to accept the adjusted position and exit the calibration screen.



Press the Power/ESC button quickly at any time while in calibration mode to exit the mode without saving changes.

9

Semi-Automatic Calibration

About

This procedure is unique to the Rugby lasers and uses the digital readout of the Combo to measure, then adjust the plane of each axis. This procedure is an alternative to the traditional method described in "8 Accuracy Adjustment".

Description

Objective: To rotate the laser to all four axes, then allow the receiver to adjust the beam automatically.

Setup

1. Pair the Combo to the laser if not already done. Refer to 4.2 Connecting Screens for the Combo.
2. Mount the laser on a flat, level surface or tripod.
3. Turn on the laser and align the X-axis toward the Combo position.
4. Mount the Combo to a fixed position, for example a stationary grade rod, approximately 30 metres (100 ft) from the laser.
5. Turn on the Combo and position the height of the Combo near or at the on-grade position. It is not necessary to be exact.
6. Enter the calibration screen within the menu and proceed with the semi auto cal.
7. The display will show the necessary steps animated.
8. Monitor the process on the screen until completion.



- With each rotation it may take up to 10 seconds for the calibration process to identify the axis being checked. Note the displayed screen indications.
- Each step of the process is very exact and may take 1 minute to complete before the ROTATE screen is displayed.
- It is important to note the screen indications to know the status of each axis in the process.
- It is not necessary to follow the steps in the exact order, but different rotation sequences result in different screen indications.
- Increasing the distance between the laser and Combo beyond 30 metres (100 ft) does not increase the accuracy of the calibration process.

Calibrating step-by-step

Step 1 - Align the X-axis (X+) towards the Combo

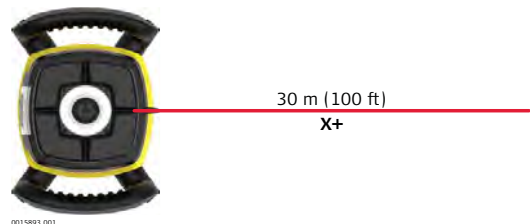

Screen Indication

Description

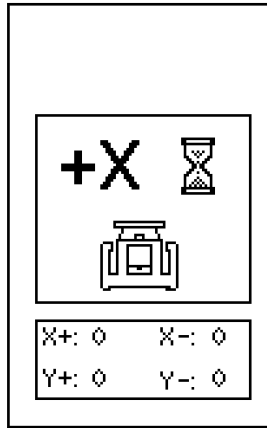
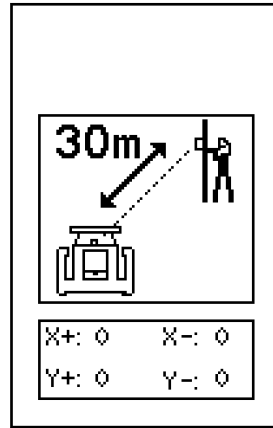

While aligning, the Rugby displays an "hour glass" screen. When the axis is successfully aligned, a "ROTATE" screen is displayed on which the first axis shows "OK".

Step 2 - Rotate the Rugby 90° and align Y-axis (Y-) towards the Combo



Screen Indication

Description

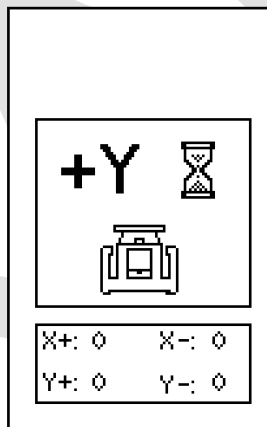
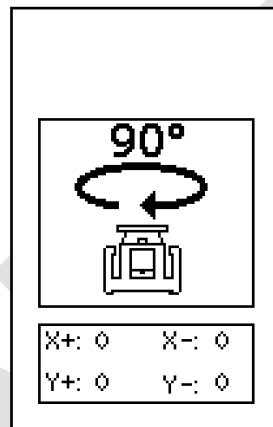

While aligning, the Rugby displays an "hour glass" screen. When the axis is successfully aligned, a "ROTATE" screen is displayed on which the second axis shows "OK".

Step 3 - Rotate the Rugby 90° and align X-axis (X-) towards the Combo

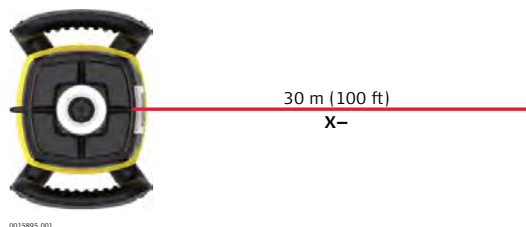

Screen Indication	Description
	<p>While aligning, the Rugby displays an "hour glass" screen.</p> <p>When the axis is successfully aligned, a "ROTATE" screen is displayed on which the third axis shows "OK".</p>

Step 4 - Rotate the Rugby 90° and align Y-axis (Y+) towards the Combo



Screen Indication	Description
	<p>While aligning, the Rugby displays an "hour glass" screen.</p> <p>When the axis is successfully aligned and the process is complete, a "COMPLETE" screen is displayed on which the fourth axis shows "OK".</p>

Calibration successful:

When all four axes have been checked and the calibration process was successful, the Rugby beeps at 5 Hz for 3 seconds, then returns to the main screen.



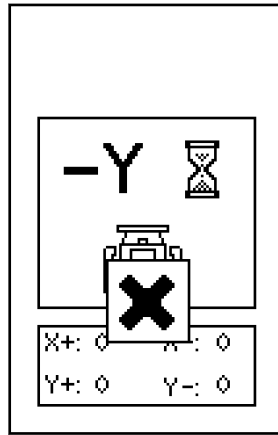

Calibration not successful:



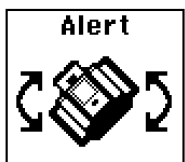

If the Rugby encounters a problem and the calibration process was not successful, the Rugby displays an "ERROR" screen for up to 2 minutes, then shuts off.

DRAFT

Alerts and message screens

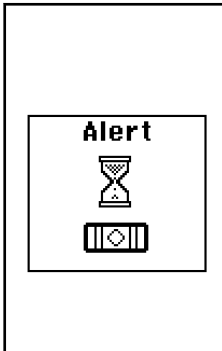
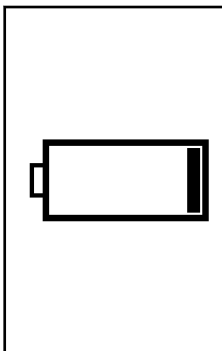
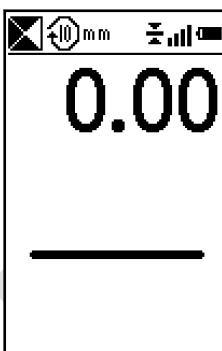
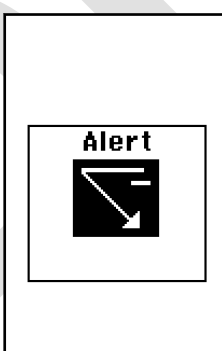
Alert	Symptom	Possible causes and solutions
	<p>Low battery indication on the display.</p>	<p>The batteries are low. Recharge the Li-Ion battery pack. Refer to 7 Batteries.</p>
	<p>Elevation (H.I.) Alert: The Elevation (H.I.) Alert screen is shown and the audio beeps. (level position)</p>	<p>The Rugby has been bumped or tripod was moved. Turn off Rugby to stop alert, check the height of the laser before beginning to work again. Allow Rugby to re-level and check the height of the laser. After 2 minutes in the alert condition, the unit will shut off automatically.</p>
	<p>Servo Limit Alert The servo limit alert screen is shown.</p>	<p>The Rugby is tipped too far to reach a level position. Relevel the Rugby within the 6 degree self-levelling range. After 2 minutes in the alert condition, the unit will shut off automatically.</p>
	<p>Tilt Alert The tilt alert screen is shown.</p>	<p>The Rugby is tipped more than 45° from level. After 2 minutes in the alert condition, the unit will shut off automatically.</p>
	<p>Temperature Alert The temperature alert screen is shown.</p>	<p>The Rugby is in an environment where it cannot operate without damaging the laser diode, for example being exposed to the heat from direct sunlight. Shade the Rugby from the sun. After 2 minutes in the alert condition, the unit will shut off automatically.</p>

Alert	Symptom	Possible causes and solutions
	<p>Temperature Check The temperature check alert screen is shown.</p>	<p>The Rugby has detected a change in temperature of 5°C and is checking the level position.</p> <p>☞ Wait until procedure is complete. Refer to 4.3.2 Menu Set 1-Temperature sensitivity for changing the setting between 5°C and 2°C.</p>
	<p>The “empty battery” icon flashes.</p>	<p>The Rugby has reached a low battery condition and changes the head speed to 7rps. If the Combo or Rod Eye detects the Rugby rotating at 7 rps, it displays a small flashing Rugby.</p> <p>☞ Check the battery of the Rugby.</p>
	<p>The beam is not emitting from all sides of the laser.</p>	<p>Beam masking is activated for two or more sides of the laser. To de-activate or change beam masking, refer to 4.3.2 Menu Set 1-Beam masking.</p>
	<p>It is not possible to enter grade greater than 10.00% or 3.000%.</p>	<p>The Rugby allows for up to 10% grade entry in both axes simultaneously. If the grade entry for one axis is greater than 10%, the cross axis is limited to 3%.</p>

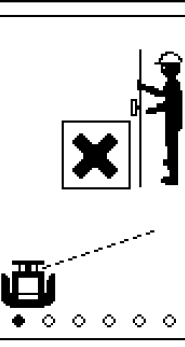
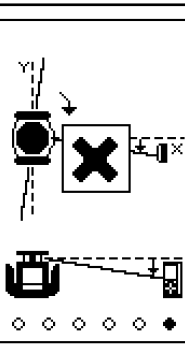
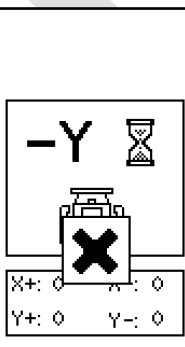
Alert	Symptom	Possible causes and solutions
	<p>The Rugby is not communicating with the Combo.</p>	<p>The Rugby has lost the communication link to the remote control.</p> <p>☞ Ensure that you are within clear sight of the Rugby and that you have not exceeded the 100 m (300') working range.</p>
	<p>Smart Target features do not work.</p>	<p>The Smart Target feature could not be completed.</p> <p>☞ Ensure that you are working on the correct axis and that you have not exceeded the 100 m (300') working range.</p>
	<p>Axis Alignment does not work.</p>	<p>The Axis Alignment procedure could not be completed.</p> <p>☞ Ensure that you are working on the correct axis and that you have not exceeded the 100 m (300') working range.</p>
	<p>Semi-automatic Calibration does not work.</p>	<p>The Semi-automatic Calibration procedure could not be completed.</p> <p>☞ Repeat the procedure. If the procedure is still not successful, contact an authorised service centre.</p>

Troubleshooting

Problem	Possible causes	Suggested solutions
The Rugby does not turn on.	The batteries are low or dead.	Check the batteries and change or charge the batteries if necessary. If the problem continues, return the Rugby to an authorised service centre for service.
The distance of the Rugby is reduced.	Dirt is reducing the laser output.	Clean the windows of the Rugby and the Combo. If the problem continues, return the Rugby to an authorised service centre for service.
The Combo is not working properly.	The Rugby is not rotating. It may be levelling or in H.I.Alert.	Check for proper operation of the Rugby.
	The Combo is out of usable range.	Move closer to the Rugby. For normal operation, the Combo works up to 300 m (1,000').
	The batteries of the Combo are low.	Check the low battery symbol on the Combo display. Change the batteries.
The display is too dark or too light.	The setting of the display contrast is unsuitable.	The contrast for the Combo can be reset in the menu. Refer to 4.3.3 Menu Set 2-Screen contrast.
The grade is shown in percent(%) or per mil (‰).	The wrong setting has been selected.	Choose the desired setting on the grade screen.
The grade resets to zero each time the laser is turned on.	The wrong setting has been selected.	Choose the desired setting on the grade screen.
The laser stops too often to re-level.	The sensitivity setting may be set to the "fine" setting (Setting 1).	The sensitivity for the Rugby can be reset in the menu of the laser. Refer to 4.3.2 Menu Set 1-Sensitivity.
	The Tripod may be unstable.	Check your tripod for stability. Tighten all screws. Use sand bags on the legs if necessary.
	The wind is causing the Rugby to move too much.	Shelter the Rugby from the wind. Press the tripod legs more firmly into the ground.
The screen of the Combo freezes or behaves unusually.	Software malfunction or strong interference from external power sources.	Try to power the Combo off and on again. If this does not resolve the issue, press the Power/ESC button of the Combo for 10 seconds.

11 Care and Transport

11.1 Transport

Transport in the field	<p>When transporting the equipment in the field, always make sure that you</p> <ul style="list-style-type: none">• either carry the product in its original container,• or carry the tripod with its legs splayed across your shoulder, keeping the attached product upright.
Transport in a road vehicle	<p>Never carry the product loose in a road vehicle, as it can be affected by shock and vibration. Always carry the product in its container, original packaging or equivalent and secure it.</p>
Shipping	<p>When transporting the product by rail, air or sea, always use the complete original Leica Geosystems packaging, container and cardboard box, or its equivalent, to protect against shock and vibration.</p>
Shipping, transport of batteries	<p>When transporting or shipping batteries, the person responsible for the product must ensure that the applicable national and international rules and regulations are observed. Before transportation or shipping, contact your local passenger or freight transport company.</p>
Field adjustment	<p>Periodically carry out test measurements and perform the field adjustments indicated in the User Manual, particularly after the product has been dropped, stored for long periods or transported.</p>

11.2 Storage

Product	<p>Respect the temperature limits when storing the equipment, particularly in summer if the equipment is inside a vehicle. Refer to "12 Technical Data" for information about temperature limits.</p>
Field adjustment	<p>After long periods of storage inspect the field adjustment parameters given in this user manual before using the product.</p>
Li-Ion batteries	<ul style="list-style-type: none">• Remove batteries from the product and the charger before storing.• After storage recharge batteries before using.• Protect batteries from damp and wetness. Wet or damp batteries must be dried before storing or use.• A storage temperature range of 0 °C to +30 °C / +32 °F to +86 °F in a dry environment is recommended to minimize self-discharging of the battery.• At the recommended storage temperature range, batteries containing a 40% to 50% charge can be stored for up to one year. After this storage period the batteries must be recharged.

11.3

Cleaning and Drying

Product and accessories

- Blow dust off lenses and prisms.
 - Never touch the glass with your fingers.
 - Use only a clean, soft, lint-free cloth for cleaning. If necessary, moisten the cloth with water or pure alcohol. Do not use other liquids; these can attack the polymer components.
-

Damp products

Dry the product, the transport container, the foam inserts and the accessories at a temperature not greater than 40°C /104°F and clean them. Remove the battery cover and dry the battery compartment. Do not repack until everything is completely dry. Always close the transport container when using in the field.

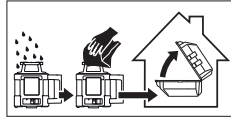

Cables and plugs

Keep plugs clean and dry. Blow away any dirt lodged in the plugs of the connecting cables.

12

Technical Data

12.1

Conformity to National Regulations

Conformity to national regulations

- FCC Part 15 (applicable in US)
- Hereby, Leica Geosystems AG declares that the radio equipment type Rugby CLH/CLA/CLI, Combo is in compliance with Directive 2014/53/EU and other applicable European Directives.
The full text of the EU declaration of conformity is available at the following internet address: <http://www.leica-geosystems.com/ce>.



Class 1 equipment according to European Directive 2014/53/EU (RED) can be placed on the market and be put into service without restrictions in any EEA member state.

- The conformity for countries with other national regulations not covered by the FCC part 15 or European Directive 2014/53/EU has to be approved prior to use and operation.
- Japanese Radio Law and Japanese Telecommunications Business Law Compliance.
 - This device is granted pursuant to the Japanese Radio Law (電波法) and the Japanese Telecommunications Business Law (電気通信事業法).
 - This device should not be modified (otherwise the granted designation number will become invalid).

Frequency band

2400 - 2483.5 MHz

Output power

< 100 mW (e. i. r. p.)

Antenna

Rugby CLH/CLA/CLI:	Chip antenna
Combo:	Chip antenna

12.2

General Technical Data of the Product

Operating range

Operating range (diame-ter)	Value
Rugby CLH/CLA/CLI	1300 m/4265 ft

Self-levelling accuracy

Type	Value
Self-levelling accuracy	±1.5 mm at 30 m (±1/16" at 100 ft)

Self-levelling accuracy is defined at 25°C (77°F).

Self-levelling range

Type	Value
Self-levelling range	±6°

Head speed

Type	Value
Head speed	0, 2, 5, 10, 15, 20 rps

Dimensions

Rugby CLH/CLA/CLI



Combo

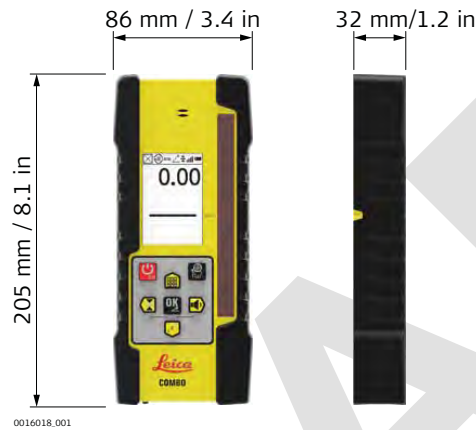

Weight

Type	Value
Rugby CLH/CLA/CLI weight with battery	3.4 kg/7.5 lbs.
Combo	0.4 kg/0.9 lbs

Internal battery for Rugby and Combo

Type	Operating times* at 20°C
Lithium-Ion (Li-Ion Pack)	50 h

*Operating times are dependent upon environmental conditions.

 Charging the Li-Ion battery pack takes a maximum of five hours.

Environmental specifications for Rugby and Combo

Temperature

Operating temperature	Storage temperature
-20°C to +50°C (-4°F to +122°F)	-40°C to +70°C (-40°F to +158°F)

Protection against water, dust and sand

Protection
Rugby: IP68 (IEC 60529) / MIL-STD-810G
Combo: IP67 (IEC 60529) / MIL-STD-810G

Protection

Dust tight

Protected against continuous immersion in water.

A100 Lithium-Ion charger

Type	Value
Type	Li-Ion battery charger
Input voltage	100 V AC-240 V AC, 50 Hz-60 Hz
Output voltage	12 V DC
Output current	3.0 A
Polarity	Shaft: negative, Tip: positive

CLB Lithium-Ion battery pack

Type	Value
Type	Li-Ion battery pack
Input voltage	12 V DC
Input current	2.5 A
Charge time	5 hours (maximum) at 20°C

DRAFT

13

Lifetime Manufacturer's Warranty

13.1

Rugby CLH/CLA/CLI

Description



Lifetime Manufacturer's Warranty

Warranty coverage for the entire usage time of the product under PROTECT according to Leica Geosystems International Limited Warranty and PROTECT General Terms & Conditions set out under www.leica-geosystems.com/protect. Free charge repair or replacement of all products or any parts under PROTECT that suffer defects as a result of faults in materials or manufacturing.

5 Years No Costs

Additional services should the product under PROTECT become defective and require servicing under normal conditions of use, as described in the user manual, at no additional charge.

Description

Two Year Knockdown Warranty

In addition to the lifetime manufacturer's warranty and the "No Cost" period for additional services, the internal self-levelling system of the product under PROTECT is covered. Should any accident or knockdown occur within two years of the purchase date, all repairs to the internal self-levelling assembly will be covered under PROTECT General Terms & Conditions.

13.2

Combo

Description



Lifetime Manufacturer's Warranty

Warranty coverage for the entire usage time of the product under PROTECT according to Leica Geosystems International Limited Warranty and PROTECT General Terms & Conditions set out under www.leica-geosystems.com/protect. Free charge repair or replacement of all products or any parts under PROTECT that suffer defects as a result of faults in materials or manufacturing.

3 Years No Costs

Additional services should the product under PROTECT become defective and require servicing under normal conditions of use, as described in the user manual, at no additional charge.

Accessories for power supply**A100 - Li-Ion Charger (790417)**

The A100 Li-Ion charger comes complete with four separate AC adaptors.

A130 - 12 Volt Battery Cable (790418)

The A130 12 volt battery cable connects the Rugby to a standard 12 volt automotive battery as a backup for the battery of the unit. Length: 4 metres/13 feet.

A140 - Car Adapter Cable (797750)

The A140 car adapter cable connects the Rugby to a standard automotive accessory jack as a backup for the battery of the unit or to charge in a vehicle. Length: 2 metres/6.5 feet.

Smart Adapter (864855)

The Smart Adapter combines the features of a wall mount bracket and a batter-board clamp. It also comes with a 90 ° Combo batter-board clamp.

CLB - Li-Ion Battery Pack (855974)

The CLB Li-Ion battery pack is included as part of the standard rechargeable package. To complete the Li-Ion battery solution, it is also necessary to purchase the A100, Li-Ion battery charger.

Rugby - Scope and Plate (864859)

The A260 Scope and Mount attaches magnetically to the top of the Rugby CLA/CLI and provides a repeatable solution for axis alignment and second day setups. The scope must be initially aligned to individual units.

A100



CLB



Rugby Scope & Plate



A130



A140



0016024.001

DRAFT

870220-1.0.0en

Original text (870220-1.0.0en)

Published in Switzerland

© 2018 Leica Geosystems AG, Heerbrugg, Switzerland

Leica Geosystems AG

Heinrich-Wild-Strasse
CH-9435 Heerbrugg
Switzerland
Phone +41 71 727 31 31

www.leica-geosystems.com



- when it has to be **right**

Leica
Geosystems