



Use the clip  or the loop  to connect

## Hammock

Attach connector cord to the bottom of the hammock by your left hip

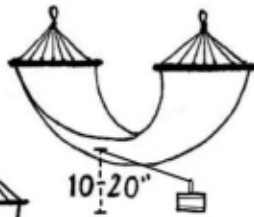
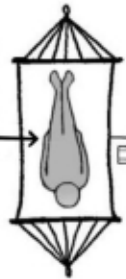

Move RokitMan into this area so that the lever is vertical in the middle of the slot

# - POWERUP -

## plug-in RokitMan

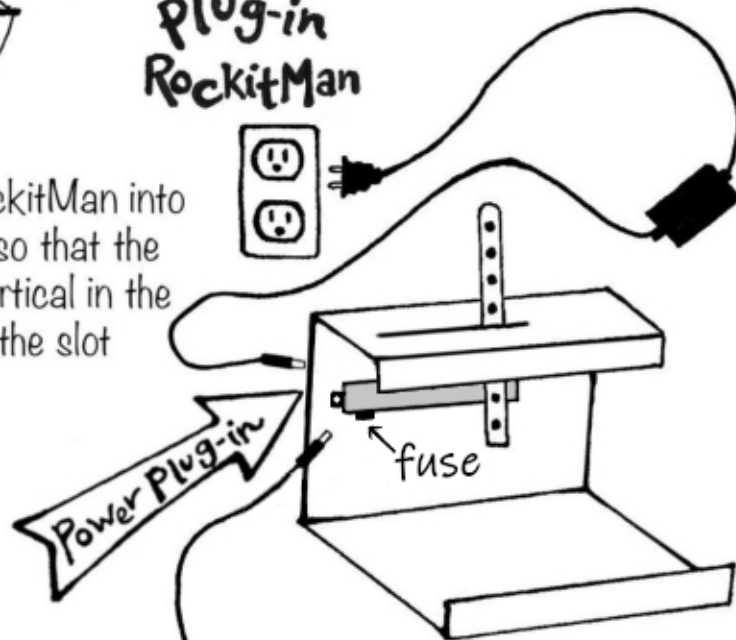
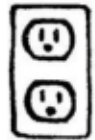

## Battery RokitMan

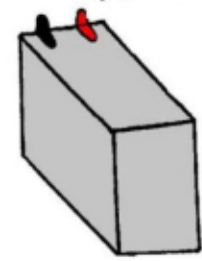

**NOTE:**  
The battery cable has one **RED** connecting wire and one **BLACK** connecting wire.

The **RED** wire must be connected to the **RED** battery post and the **BLACK** wire must be connected to the **BLACK** battery post.

If reversed, the RokitMan will not rock it, and you will need to replace the fuse on the green circuit board.

## Hammock

Get in on the side opposite RokitMan

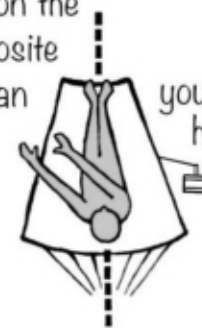

Center yourself in the hammock



Wave your arms side to side once per second to start

## Porch swing

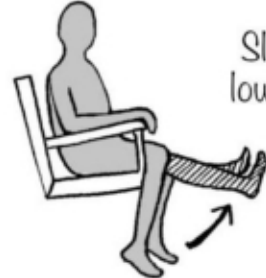

Slowly kick lower legs to start

## Hammock chair



Slowly kick lower legs to start

## Porch swing



Attach connector cord near center of swing

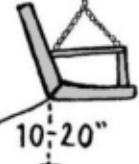

## Hammock chair



Attach connector cord to front or back of chair



Centered side to side

# - TROUBLESHOOTING -

If your RockitMan™ won't rock:

Make sure you have **POWER**

**Battery** ✓ Battery fully charged?  
**RockitMan** ✓ Check the fuse on the green circuit board

**plug-in** ✓ Plugged in on both ends?  
**RockitMan** ✓ Check the circuit breaker

Make sure RockitMan is in the **right position**

When you are lying/sitting still  
in your hammock/swing,  
RockitMan should  
look like this:

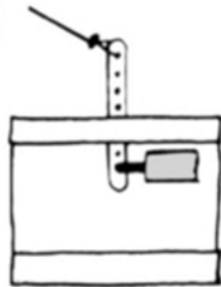

When you are swinging,  
RockitMan should look like this:

Taut when hammock  
swings **away** from  
RockitMan

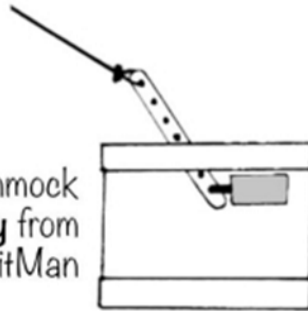

or

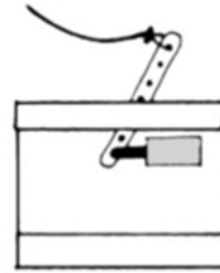

Slack when hammock  
swings **toward**  
RockitMan

Not like this:

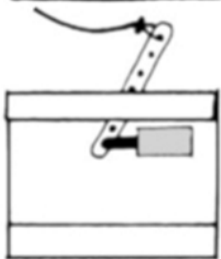

or

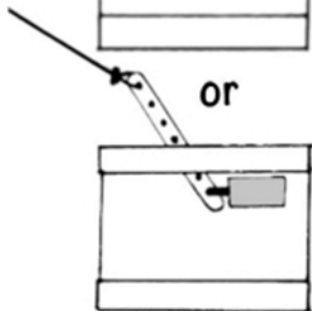

If it looks like this instead:

Move RockitMan  
**away** from your  
hammock/swing  
until it looks like  
this

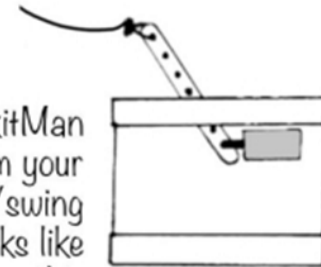

or

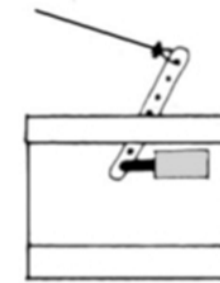

Move RockitMan  
**toward** your  
hammock/swing  
until it looks like  
this