

# SIDELINE® ELITE SERIES ELECTRIC FIREPLACE HEATER

Model # : 80036, 80037, 80038, 80042, 80044, 80050

## OWNER'S MANUAL

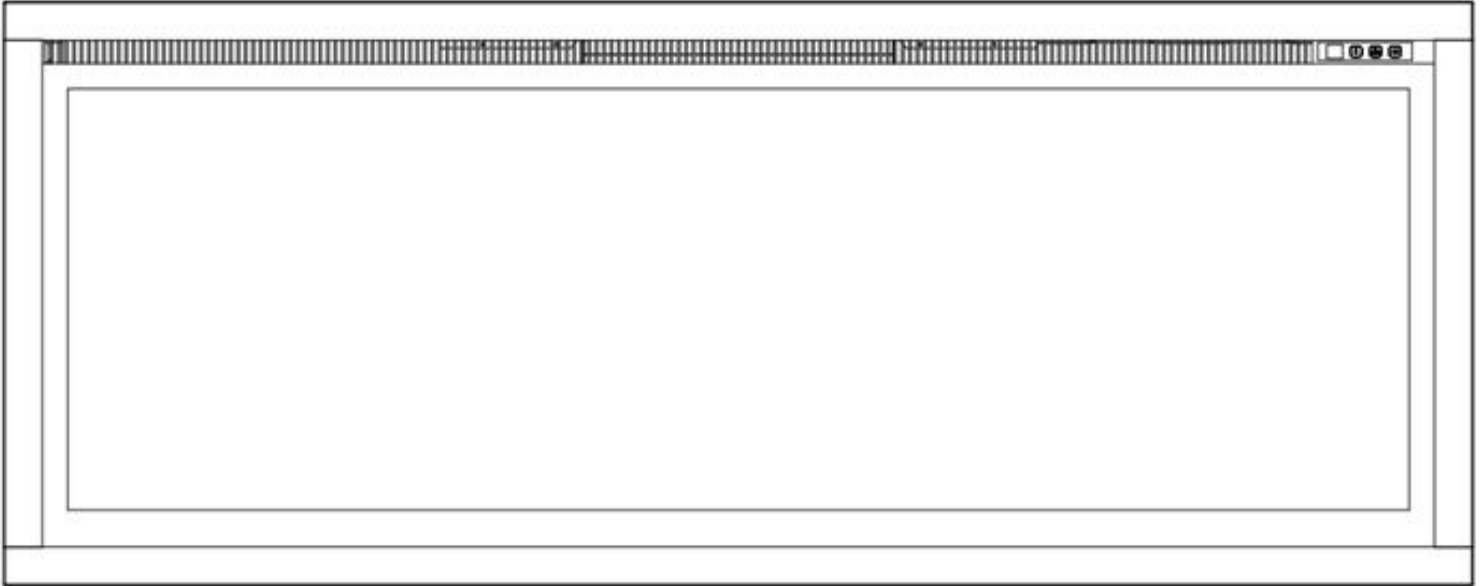

### Sideline® Elite Series 42", 50", 60", 72", 84", 100" Recessed Electric Fireplace

AC 110-120V 60Hz 1500W

#### WARNING

Read and understand this entire owner's manual, including **all safety information**, before plugging in or **using** this product. Failure to do so could result in **fire, electric shock, or serious personal injury**.

#### CAUTION

Keep this owner's manual for future reference. If you sell or give this product away, **make sure this manual accompanies this product**.



PREMIUM  
ELECTRIC FIREPLACES  
& TV LIFTS

Exceeding Expectations



## Table of Contents

General Information.....	4
<i>CSA Approval Listing Information</i> .....	4
<i>Fireplace Specifications</i> .....	4
<i>Serial Number Label</i> .....	5
<i>Dimensional Drawings</i> .....	6
80036 – Sideline® Elite 50” Dimensions.....	6
80037 – Sideline® Elite 60” Dimensions.....	7
80038 – Sideline® Elite 72” Dimensions.....	8
80042 – Sideline® Elite 42” Dimensions.....	9
80044 – Sideline® Elite 100” Dimensions.....	10
80050 – Sideline® Elite 84” Dimensions.....	11
Unpacking Your Fireplace.....	12
<i>Parts and Hardware</i> .....	12
<i>Unpacking and Setup</i> .....	12
<i>Wiring</i> .....	13
<i>Hard Wire Connection</i> .....	14
Installation.....	15
<i>Choosing Installation Location</i> .....	15
<i>Removing The Glass Panel</i> .....	16
<i>Recessed Installation</i> .....	17
<i>Installing the Crystal Embers and Drift Wood Logs</i> .....	20
Crystal Ember Installation .....	20
Installing the Drift Wood Logs.....	20
<i>Reinstalling the Glass Panel</i> .....	21
<i>Wall Mounted Installation</i> .....	22
Operating Fireplace.....	25
<i>Power</i> .....	25
<i>Methods of Operation</i> .....	25
Control Panel Functions.....	26
Wireless Remote Control Functions .....	27
<i>Remote Control Operation</i> .....	29
Changing Remote Battery.....	<b>Error! Bookmark not defined.</b>
<i>Temperature Limiting Control</i> .....	29
Care and Maintenance.....	30
<i>Cleaning</i> .....	30
<i>Maintenance</i> .....	30
Warranty .....	31

# IMPORTANT SAFETY INFORMATION WARNING!

- **THIS FIREPLACE IS HOT WHEN IN OPERATION AND CAN CAUSE SEVERE BURNS**
- Do not operate fireplace before reading and understanding operating instructions. Failure to operate fireplace according to operating instructions could cause fire or injury.
- Risk of burns. This fireplace is HOT when in operation and heating element is ON. Power to the fireplace should be turned off and the fireplace allowed to cool before servicing. To disconnect power to the fireplace, turn controls to off, then remove plug from outlet.
- Do not install damaged, incomplete, or substitute components.
- Young children should be carefully supervised when they are in same room with fireplace. Toddlers, young children and others may be susceptible to accidental contact burns. A physical barrier is recommended if there are at risk individuals in the house. To restrict access to the fireplace, install an adjustable safety gate to keep toddlers, young children and other at risk individuals away from the fireplace and hot surfaces.
- Clothing and other flammable material should not be placed on or near the fireplace.
- Due to high temperatures, the fireplace should be located out of traffic and away from furniture and draperies.
- Ensure that you have incorporated adequate safety measures to protect infants/toddlers from touching hot surfaces.
- It is imperative that the control compartments, circulating blower, and its passageway is kept clean.
- Under no circumstances should this fireplace be modified.
- Do not use the fireplace if any part has been under water.
- Do not operate the fireplace with the glass panel removed, cracked or broken.
- Keep the packaging material out of the reach of children. As with all plastic bags, these are not toys and should be kept away from children and infants.
- Servicing should only be done while the fireplace is disconnected from the power outlet.
- Unplug fireplace if not being used for an extended period of time.
- Do not operate this fireplace with a damaged cord or plug after the fireplace malfunctions, has been dropped, or damaged in any manner.
- Do not use outdoors.
- Never locate fireplace where it may fall into a bathtub or other water container.
- Do not run the cord under carpeting. Do not cover cord with throw rugs, runners, or the like. Arrange cord away from traffic area and where it will not be tripped over.
- Connect to properly grounded outlets only.
- Do not insert foreign objects into any ventilation or exhaust opening as this may cause an electric shock, fire, or damage to the fireplace.
- To prevent a possible fire, do not block the air intakes or exhaust in any manner. Do not use on soft surfaces, like a carpet, where openings may be blocked.
- Ensure clearances to combustibles are maintained when building a mantel or shelves above the fireplace. Elevated temperatures on the wall or in the air above the fireplace can cause melting, discoloration or damage to the decorations, a TV or other electronic components.

## General Information

### CSA Approval Listing Information

This fireplace has been tested in accordance with the CSA Standards for fixed and location-dedicated electric room appliances in the United States and Canada. If you need assistance during installation, please contact our technical support department at 800-215-1990.

**Note: This fireplace must be electrically wired and grounded in accordance with local codes or, in the absence of local codes, with National Electric Code ANSI/NFPA 70-latest edition in the United States or the Canadian Electric Code, CSA C22.1 in Canada.**

### Fireplace Specifications

Model Number	80036	80037	80038
Description	Sideline® Elite 50"	Sideline® Elite 60"	Sideline® Elite 72"
Voltage	120v AC	120v AC	120v AC
Watts	Max 1500W	Max 1500W	Max 1500W
Amps	15 AMP	15 AMP	15 AMP
Fireplace Width	49 ¾"	59 ¾"	71 ¾"
Fireplace Height	19 ¾"	19 ¾"	19 ¾"
Fireplace Depth	5 ½"	5 ½"	5 ½"
Shipping Weight	63 lbs	73 lbs	90 lbs
Fireplace Weight	50 lbs	60 lbs	77 lbs

Model Number	80042	80044	80050
Description	Sideline® Elite 42"	Sideline® Elite 100"	Sideline® Elite 84"
Voltage	120v AC	120v AC	120v AC
Watts	Max 1500W	Max 1500W	Max 1500W
Amps	15 AMP	15 AMP	15 AMP
Fireplace Width	41 ¾"	99 ¾"	83 ¾"
Fireplace Height	19 ¾"	19 ¾"	19 1/4"
Fireplace Depth	5 ½"	5 ½"	5 ½"
Shipping Weight	48 lbs	140 lbs	120 lbs
Fireplace Weight	40 lbs	127 lbs	102 lbs

## Serial Number Label

Each Touchstone Home Products Electric Fireplace contains a serial number label on the shipping box. Please remove the shipping label and place the label on the back page of this manual for future reference.



## Dimensional Drawings

### 80036 – Sideline® Elite 50” Dimensions

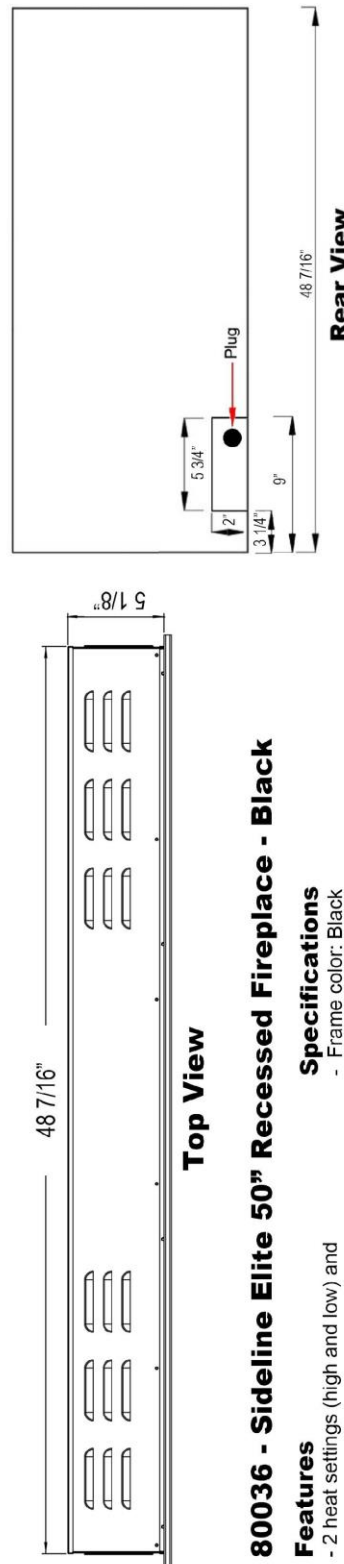
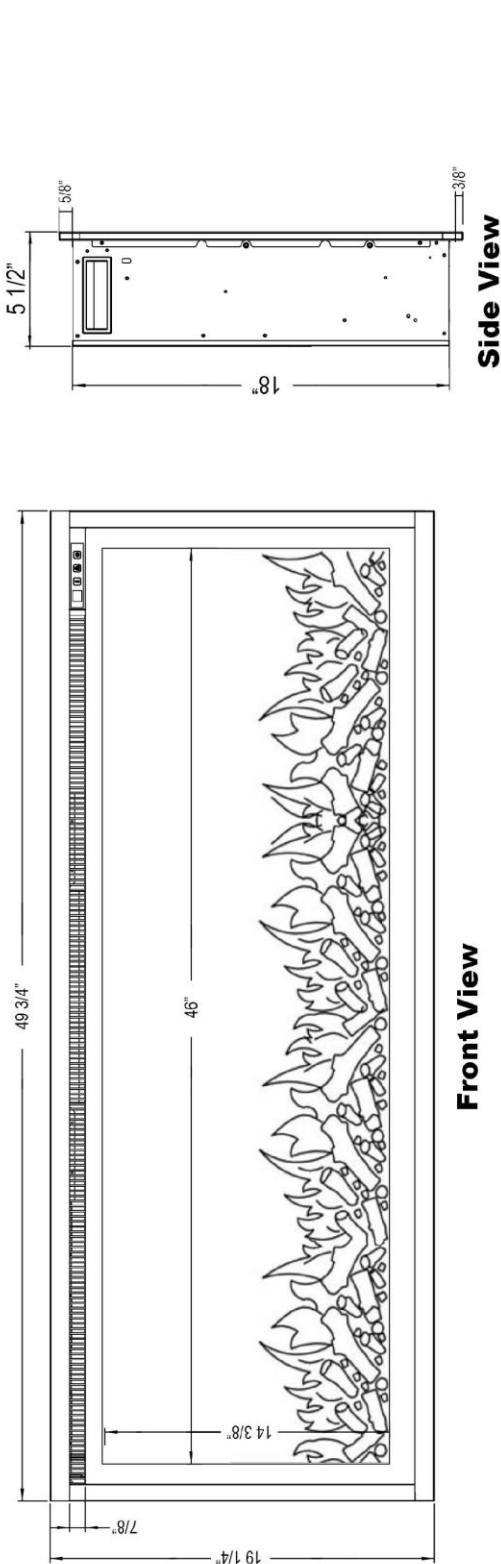

#### 80036 - Sideline Elite 50” Recessed Fireplace - Black

##### Features

- 2 heat settings (high and low) and Programmable thermostat
- 3 speed flame options
- 10 color media bed and 6 color flame options
- Designed for recessed mounting in wall
- Remote control for heat and flame setting (batteries not included)
- Dual mode, operates with or without heat for only flame effect
- Built in timer: 1 to 8 hours
- Faux drift wood fire logs and glass crystal media options

##### Specifications

- Frame color: Black
- Watts: 1,500
- BTUs: 5,000
- Room Coverage: 400 ft.
- Voltage: 110V-120V
- Amperes: 12
- Rough Opening: 48 3/4"W x 18 1/4"H x 6"D

#### Sideline Elite 50” Recessed Fireplace PN: 80036



PREMIUM  
ELECTRIC FIREPLACES  
& TV LIFTS

Exceeding Expectations

Updated: 04/17/2019

## 80037 – Sideline® Elite 60” Dimensions

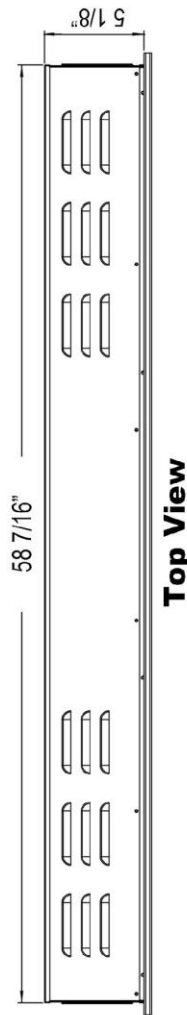
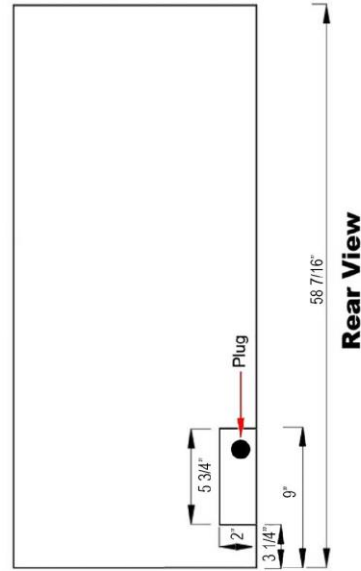
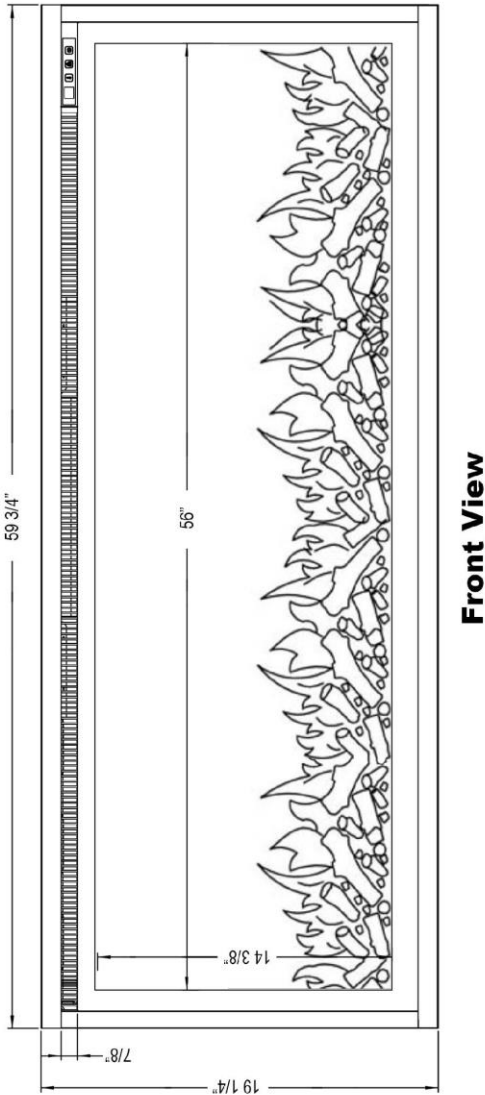
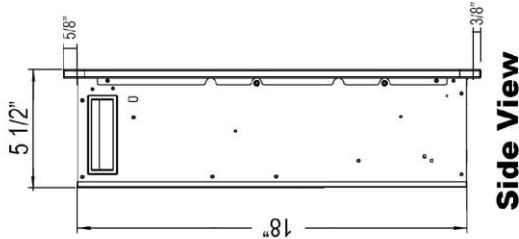

### 80037 - Sideline Elite 60” Recessed Fireplace - Black

**Features**

- 2 heat settings (high and low) and Programmable thermostat
- 3 speed flame options
- 10 color media bed and 6 color flame options
- Designed for recessed mounting in wall
- Remote control for heat and flame setting (batteries not included)
- Dual mode, operates with or without heat for only flame effect
- Built in timer: 1 to 8 hours
- Faux drift wood fire logs and glass crystal media options

**Specifications**

- Frame color: Black
- Watts: 1,500
- BTU's: 5,000
- Room Coverage: 400 ft.
- Voltage: 110V-120V
- Amperes: 12
- Rough Opening: 58 3/4"W x 18 1/4"H x 6"D

Sideline Elite 60” Recessed Fireplace  
PN: 80037



**PREMIUM  
ELECTRIC FIREPLACES  
& TV LIFTS**

Exceeding Expectations

## 80038 – Sideline® Elite 72” Dimensions

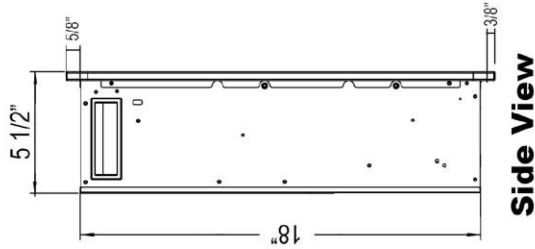

**Side View**

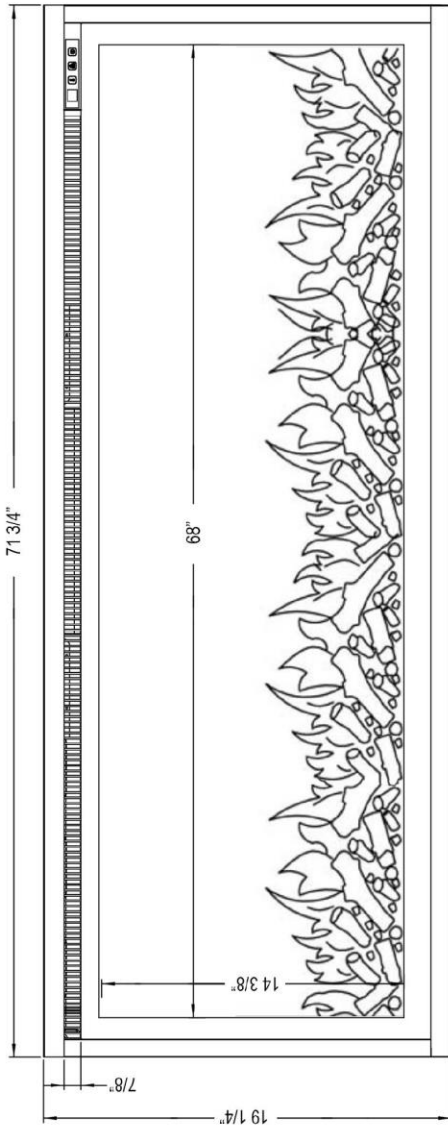

**Front View**

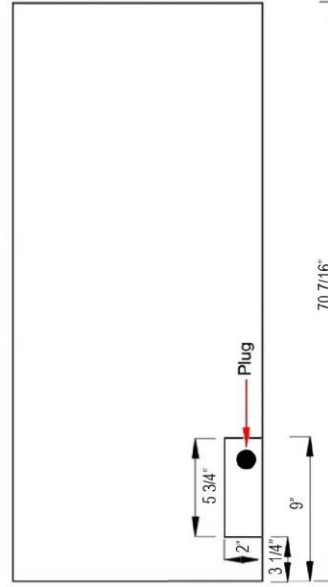

**Rear View**

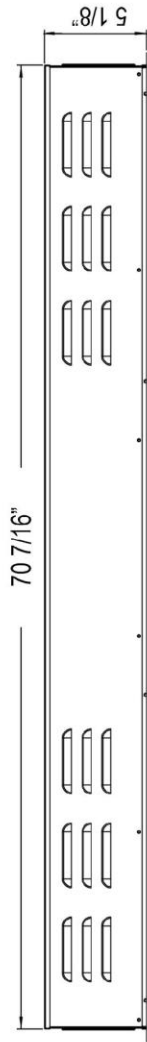

**Top View**

### 80038 - Sideline Elite 72” Recessed Fireplace - Black

**Features**

- 2 heat settings (high and low) and Programmable thermostat
- 3 speed flame options
- 10 color media bed and 6 color flame options
- Designed for recessed mounting in wall
- Remote control for heat and flame setting (batteries not included)
- Dual mode, operates with or without heat for only flame effect
- Built in timer: 1 to 8 hours
- Faux drift wood fire logs and glass crystal media options

**Specifications**

- Frame color: Black
- Watts: 1,500
- BTU's: 5,000
- Room Coverage: 400 ft.
- Voltage: 110v-120v
- Amperes: 12
- Rough Opening: 70 3/4"W x 18 1/4"H x 6"D

Sideline Elite 72” Recessed Fireplace  
PN: 80038



**PREMIUM  
ELECTRIC FIREPLACES  
& TV LIFTS**

Exceeding Expectations



## 80042 – Sideline® Elite 42” Dimensions

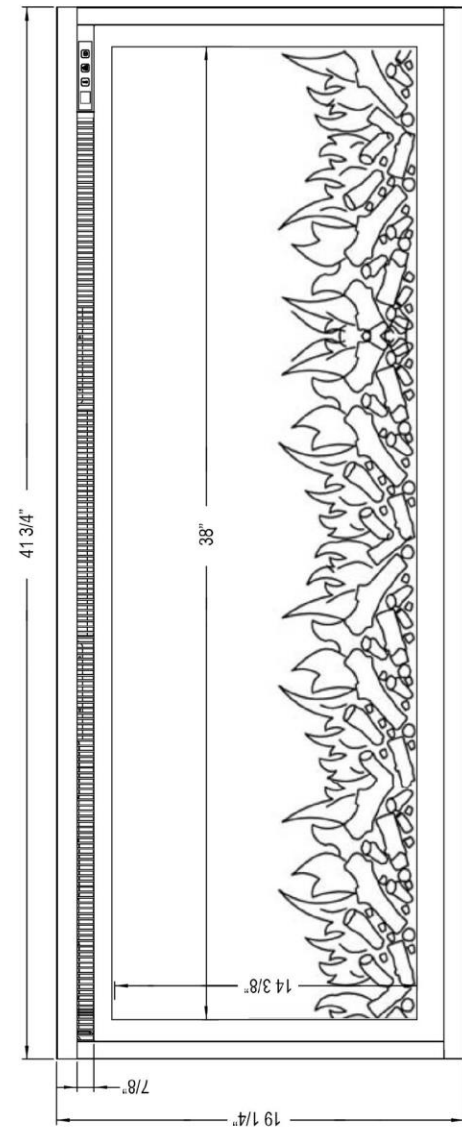
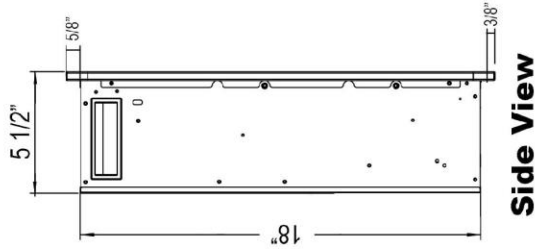

**Front View**

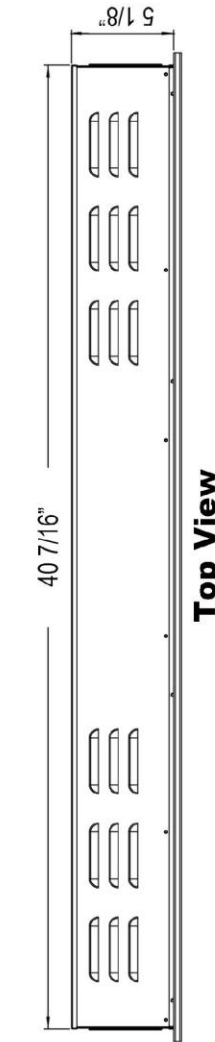
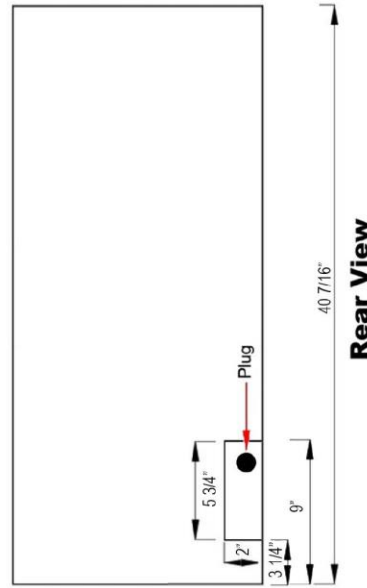

**Top View**

### 80042 - Sideline Elite 42” Recessed Fireplace - Black

**Features**

- 2 heat settings (high and low) and Programmable thermostat
- 3 speed flame options
- 10 color media bed and 6 color flame options
- Designed for recessed mounting in wall
- Remote control for heat and flame setting (batteries not included)
- Dual mode, operates with or without heat for only flame effect
- Built in timer: 1 to 8 hours
- Faux drift wood fire logs and glass crystal media options

**Specifications**

- Frame color: Black
- Watts: 1,500
- BTU's: 5,000
- Room Coverage: 400 ft.
- Voltage: 110v-120v
- Amperes: 12
- Rough Opening: 40 3/4"W x 18 1/4"H x 6"D

Sideline Elite 42” Recessed Fireplace  
PN: 80042



PREMIUM  
ELECTRIC FIREPLACES  
& TV LIFTS

Exceeding Expectations

Updated: 09/12/2019

## 80044 – Sideline® Elite 100” Dimensions

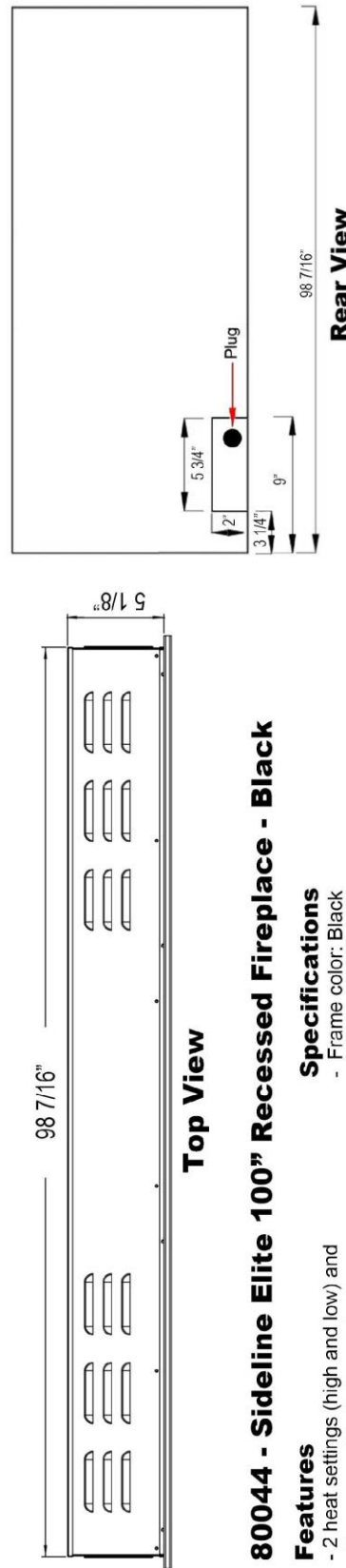
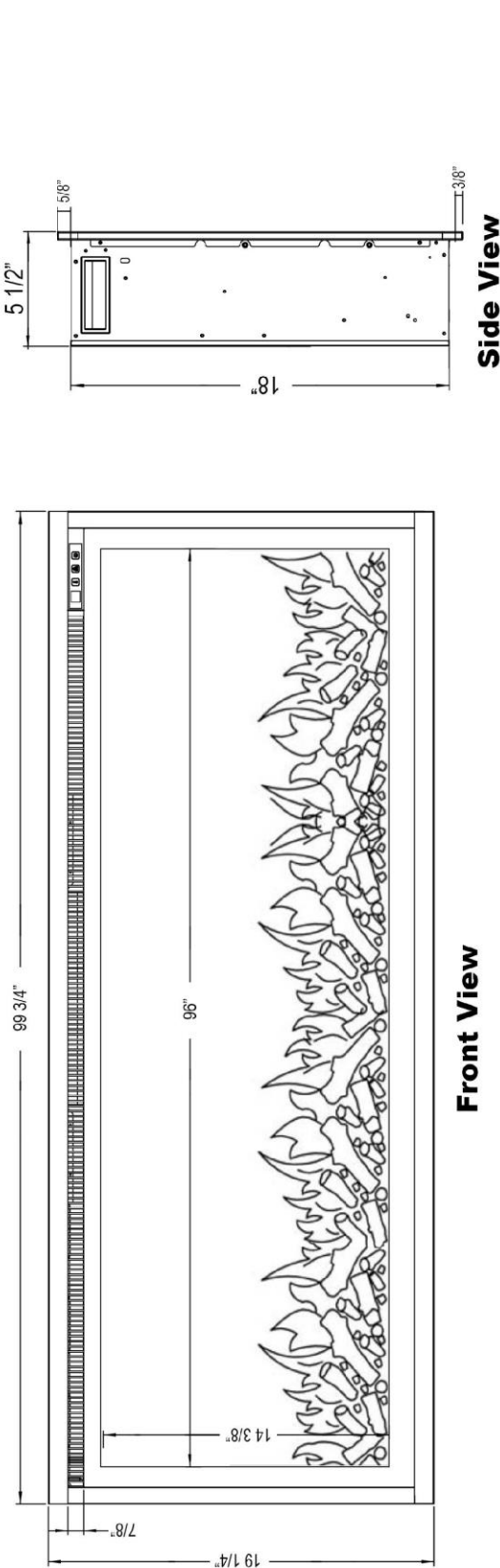

### 80044 - Sideline Elite 100" Recessed Fireplace - Black

**Features**

- 2 heat settings (high and low) and Programmable thermostat
- 3 speed flame options
- 10 color media bed and 6 color flame options
- Designed for recessed mounting in wall
- Remote control for heat and flame setting (batteries not included)
- Dual mode, operates with or without heat for only flame effect
- Built in timer: 1 to 8 hours
- Faux drift wood fire logs and glass crystal media options

**Specifications**

- Frame color: Black
- Watts: 1,500
- BTUs: 5,000
- Room Coverage: 400 ft.
- Voltage: 110v-120v
- Amperes: 12
- Rough Opening: 98 3/4"W x 18 1/4"H x 6"D

Sideline Elite 100" Recessed Fireplace  
 PN: 80044



**PREMIUM  
 ELECTRIC FIREPLACES  
 & TV LIFTS**  
 Exceeding Expectations

## 80050 – Sideline® Elite 84” Dimensions

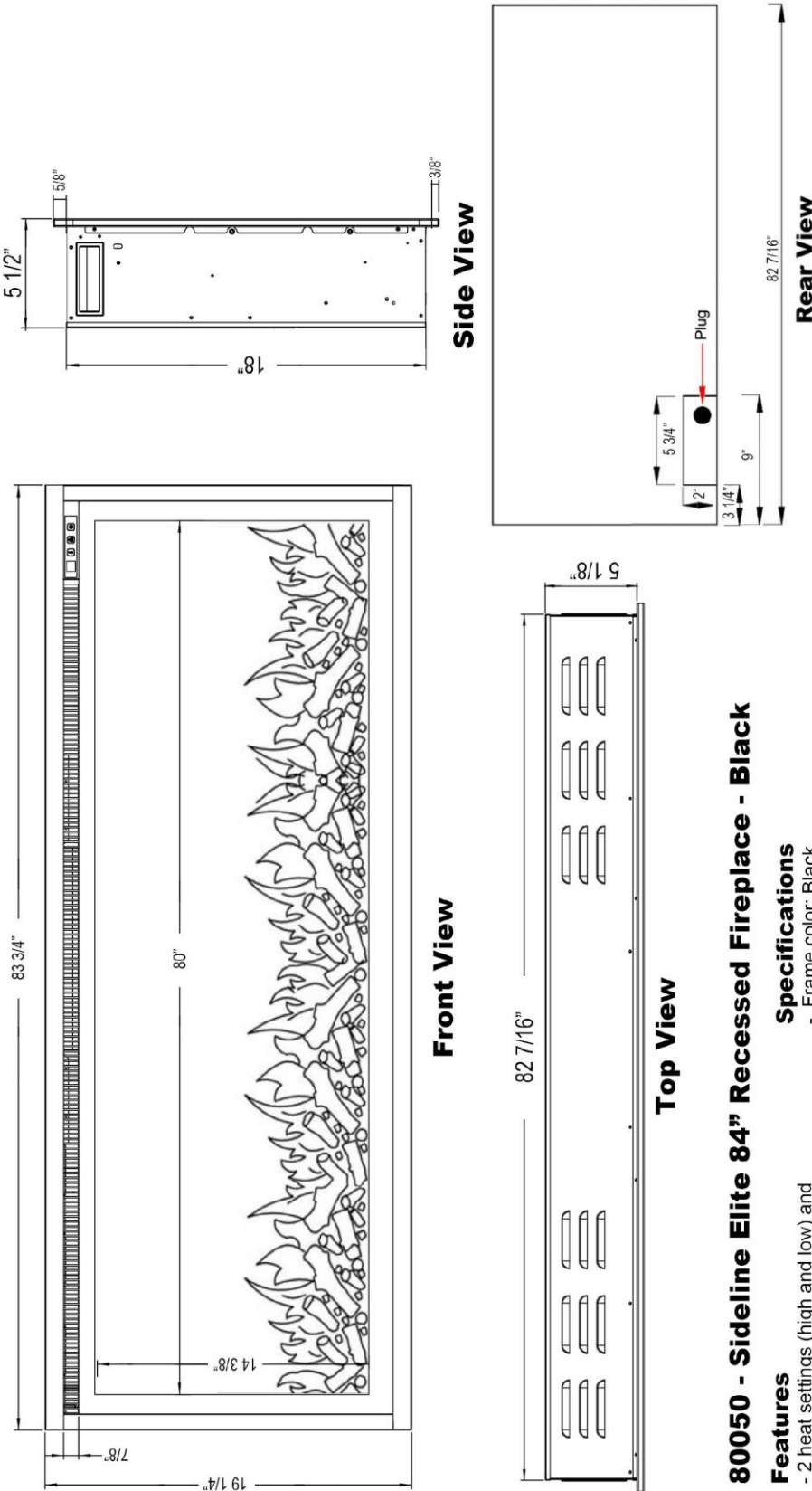

**Sideline Elite 84” Recessed Fireplace**  
 PN: 80050



Updated: 2/28/2022

### 80050 - Sideline Elite 84” Recessed Fireplace - Black

**Features**

- 2 heat settings (high and low) and Programmable thermostat
- 3 speed flame options
- 10 color media bed and 6 color flame options
- Designed for recessed mounting in wall
- Remote control for heat and flame setting (batteries not included)
- Dual mode, operates with or without heat for only flame effect
- Built in timer: 1 to 8 hours
- Wifi-Enabled through the Tuya Smart App
- Amazon Alexa and Google Assistant Compatible
- Faux drift wood fire logs and glass crystal media options

**Specifications**

- Frame color: Black
- Watts: 1500
- BTU's: 5000
- Room Coverage: 400 ft.
- Voltage: 110V-120V
- Amperes: 12
- Rough Opening: 82 3/4"W x 18 1/4"H x 6"D









# Unpacking Your Fireplace

## Parts and Hardware

### Tools Required

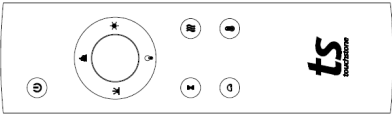
- Phillips screwdriver
- Stud finder
- Level
- Tape measure
- Electric drill
- 1/4” wood drill bit

### What’s in the Box

 <p>Sideline Elite Fireplace</p>	 <p>Wood Screws - 6</p>	 <p>Drywall Anchors - 6</p>
 <p>Wall Mount Bracket (attached to back of fireplace)</p>	 <p>Remote Control</p>	 <p>Metal Bracket</p>
 <p>Crystal Embers (Large and Small)</p>	 <p>Plastic Tray (installed under log set in fireplace)</p>	 <p>Drift Wood Fire Logs</p>

## Unpacking and Setup

### Unpacking Instructions

- Remove all parts and hardware from the carton and place them on a clean, soft, dry surface. Check the parts list to make sure no parts are missing. If parts are missing, please contact technical support at 800-215-1990 for replacement parts.

**NOTE:** *Dispose of plastic bag, as it may cause choking hazard with young children. Do not let children play with plastic bag.*

## Wiring

The Sideline® Elite series recessed fireplace can either be plugged into a grounded 3-prong outlet or hard wire connection.

### Testing the Fireplace Prior to Installation

- Before installing the fireplace, test the fireplace to make sure that it operates properly.
- Plug fireplace into approved outlet and power on fireplace. Once fireplace is tested, continue with installation.
- If you have any problems, please contact technical support at 800-215-1990 opt 2.

### 3-prong Outlet Installation

- Only use this fireplace on a 120V AC, 15-Amp grounded circuit. Never overload the circuit. If this fireplace trips the circuit breaker, unplug all other appliances on the same circuit before the next use. Avoid plugging other appliances into the same circuit as this fireplace.
- Always check the fireplace plug and connections before each use.
- Never plug this fireplace into an outlet that is cracked or has any loose wires or connections. Plugging this fireplace into a faulty outlet could result in the outlet overheating or catching fire.
- Make sure this plug fits securely into the outlet. Faulty wall outlet connections or loose plugs can cause the outlet to overheat. If the outlet or faceplate is hot, discontinue use immediately and have a qualified electrician inspect and/or replace the faulty outlet.
- The power cord supplied with the heater has three prongs: two flat blades (live and neutral) and one round pin (ground). If a 3-slot receptacle is not available, an adapter **MUST** be used. The adapter **MUST** be **properly grounded** to the outlet box (see figure below).

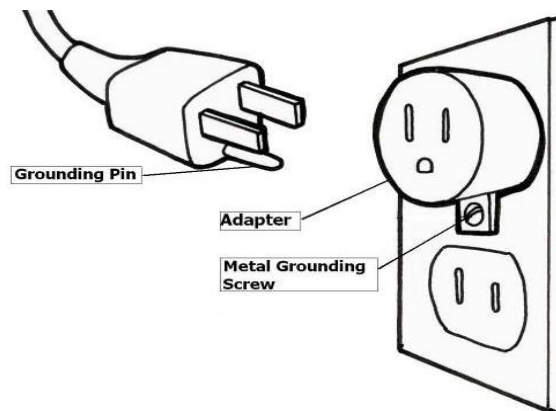

**NOTE: Adapter NOT INCLUDED.**

## Hard Wire Connection

If it is necessary to hard wire this appliance, a qualified electrician must remove the cord connection, and wire the appliance directly to the house hold wiring.

This appliance must be electrically connected and grounded in accordance with local codes, if hard wired. In the absence of local codes, use the current ANSI/NFPA 70 NATIONAL ELECTRICAL CODE in the United States or the current CSA C22.1 CANADIAN ELECTRICAL CODE in Canada.

Fig. 1

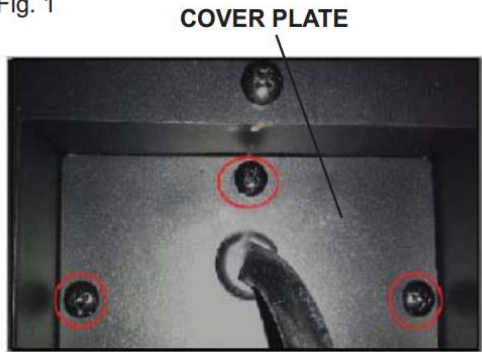
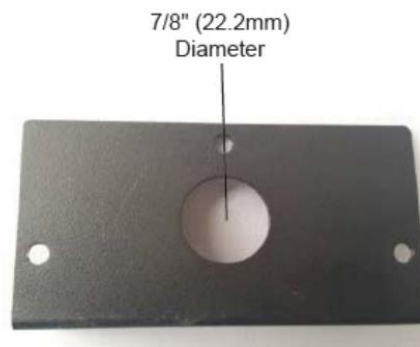
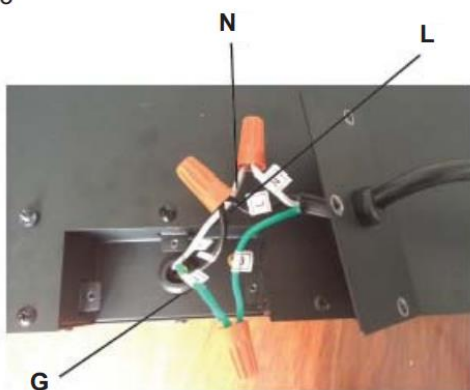

Fig. 2



- A. Remove the cover plate from the right side bottom of the appliance by removing the three screws, as shown above. Save screws for installation of new cover plate.
- B. Remove the wire connectors from the power cord. Keep power cord, in case needed in future.
- C. Remove the power cable and wires from the cover plate. Thread your wiring through the hole in the cover plate for connecting to the wires in the Sideline® Elite fireplace.
- D. Using the wire connectors, connect the ground green wires (G), the common white wires (N) together, and then the hot black wires (L) Refer to Figure 3 when complete.
- E. Reinstall the cover plate using the three screws, as shown in Figure 1.

Fig. 3



# Installation

## WARNINGS

- Due to high temperatures, keep the fireplace out of high traffic locations.
- Keep combustible materials, such as furniture, pillows, bedding, papers, clothes, and curtains at least 36” away from the front of the fireplace.
- Never install the fireplace where it may fall into a bathtub or other body of water.
- Wear safety gloves and safety glasses for protection during installation. Broken glass may cause injury or harm.
- Prevent contact with loose insulation. Do not install the fireplace against a vapor barrier or exposed insulation.
- Do not expose the fireplace to the elements (rain, etc).

## Choosing Installation Location

### Choosing Wall Location

- Measure wall location to ensure that fireplace will fit on desired wall location.
- Minimum clearances (measurements taken from front of glass panel):

<b>Bottom of Fireplace to Floor:</b>	6”	<b>Top of Fireplace:</b>	8” to mantel
<b>Sides of Fireplace:</b>	0”	<b>Top of Fireplace:</b>	8” to TV
<b>Back of Fireplace:</b>	0”	<b>Top of Fireplace:</b>	8” to ceiling

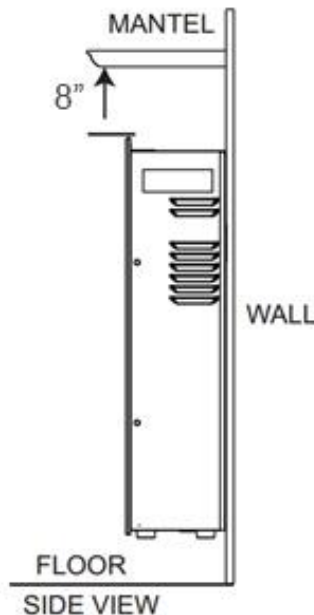

- Select a location that is not prone to moisture and is located at least 36” away from combustible materials such as curtains, drapes, furniture, bedding, or other combustible materials.
- See Safety Information on p. 4 for warnings about safe placement, safe installation, and proper use of this product.

## Removing The Glass Panel

Remove the glass panel prior to installation. Please remove glass panel as per instructions below:

### Instructions:

1. There are 2 screws in the top vent opening, one on the far left and one on the far right that secure the left and right trim pieces in place. Remove both screws to remove the trim pieces.

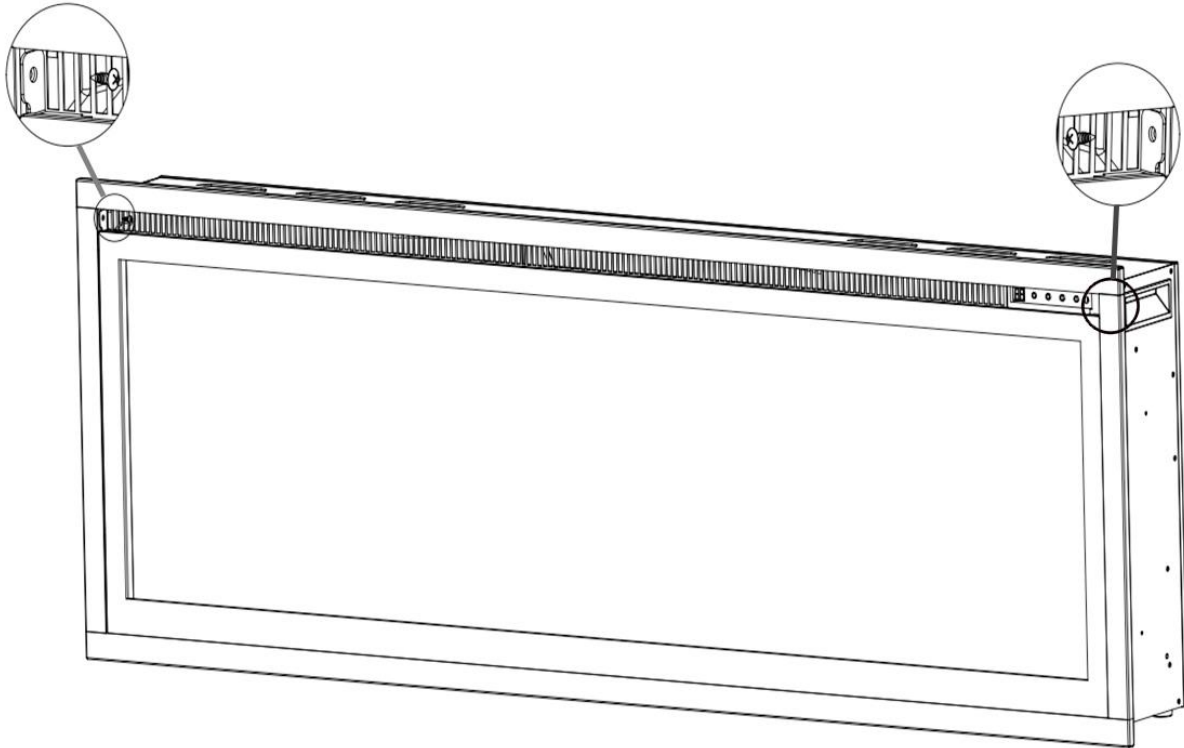

2. After removing screws, tilt glass panel away from the fireplace. Lift the glass panel away from the fireplace to remove the glass panel. Store the glass panel in a soft, dry place.

**CAUTION:** It is recommended that 2 people remove the glass panel to minimize chance of breakage.

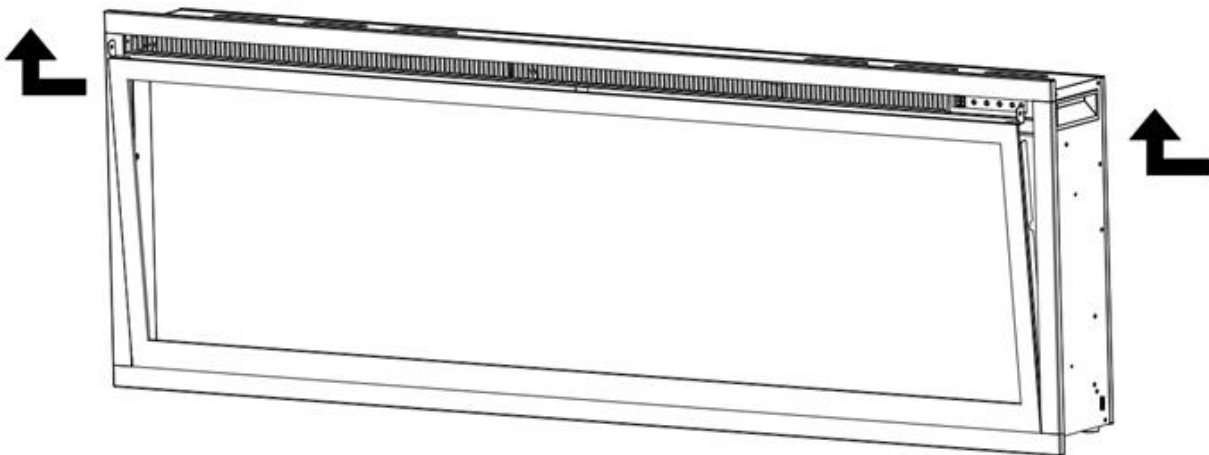



## Recessed Installation

- Due to many different finish materials used on walls, it is highly recommended that you consult your local builder before you install this fireplace in the wall.
- Select a location that is not prone to moisture and is located at least 36” away from combustible materials such as curtains, drapes, furniture, bedding, or other combustible materials.
- In order to avoid the possibility of exposed insulation or vapor barrier coming in contact with the fireplace, it is recommended that the walls of the fireplace enclosure be “finished” (ie. Sheetrock, drywall, etc) as you would finish any other outside wall of your home. This will ensure that clearance to combustibles is maintained within the wall cavity.
- Never install fireplace into load-bearing walls. When recessing fireplace in a wall, recess into non-load bearing walls ONLY!

### Instructions:

1. Choose a location in the wall to install fireplace.
2. Create opening in the wall that is no more than ¼” larger than metal firebox portion of fireplace.

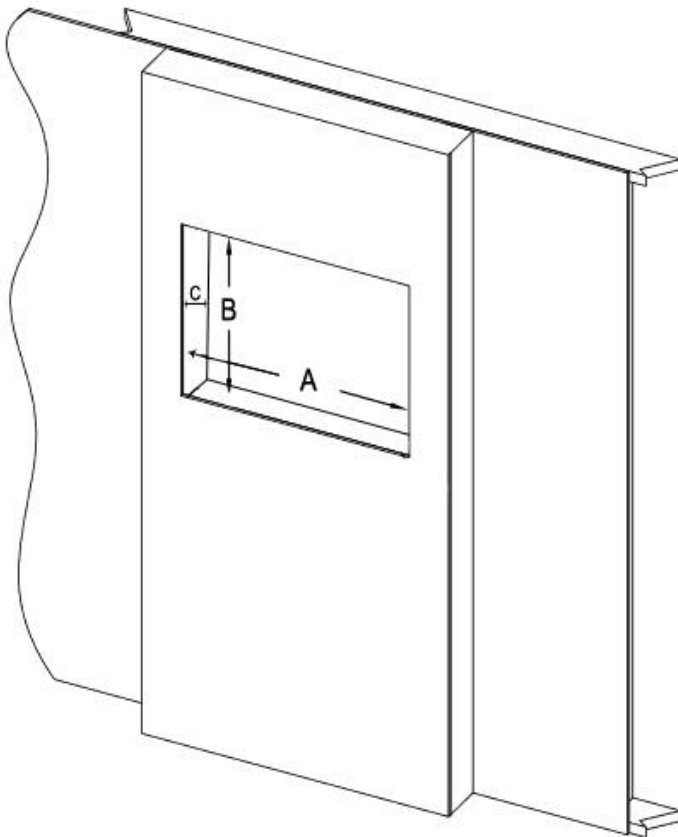

**Rough Opening Dimensions**

Model	A (Width)	B (Height)	C (Depth)
<b>80036</b>	48 ¾”	18 ¼”	6”
<b>80037</b>	58 ¾”	18 ¼”	6”
<b>80038</b>	70 ¾”	18 ¼”	6”
<b>80042</b>	40 ¾”	18 ¼”	6”
<b>80044</b>	98 ¾”	18 ¼”	6”
<b>80050</b>	80 ¾”	18 ¼”	6”

## Recessed Installation – cont.

3. Install the wall anchors (if wall opening is covered in sheetrock) according to the dimensions shown in the drawing below:

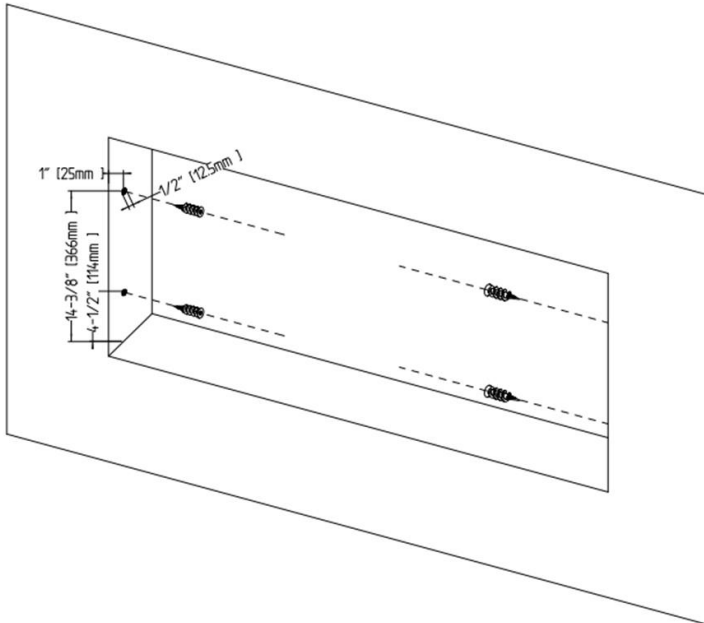

a. Install wall anchors

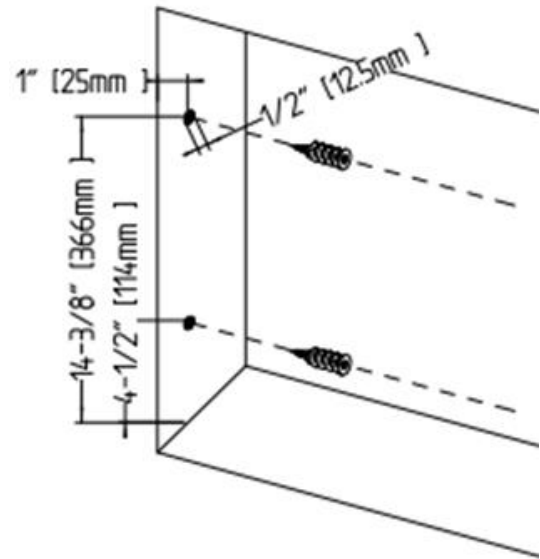

b. Close-up for dimensions for wall anchor installation

4. Remove the 2 brackets on each side of the flame area as shown below. Keep the screws and brackets handy, as they will be re-installed later.

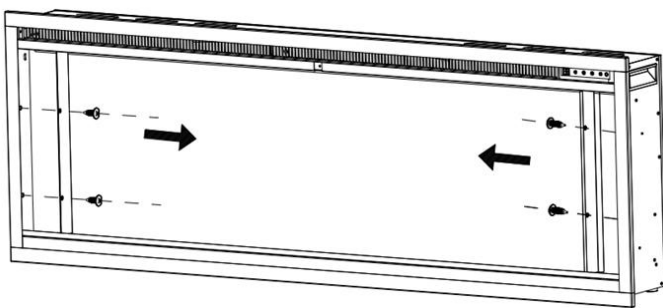

a. Remove screws holding brackets in place

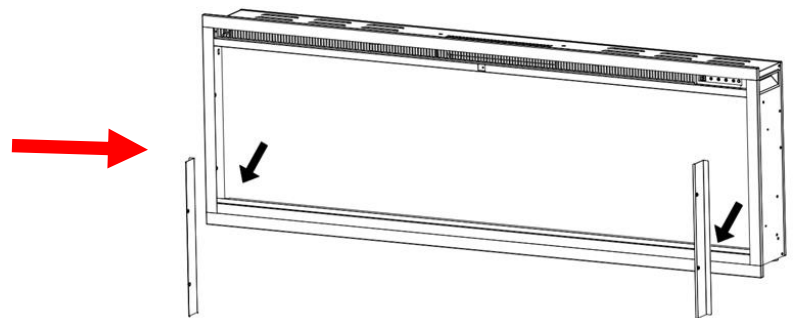

b. Remove brackets

## ***Recessed Installation – cont***

5. With the help of a second person, insert the fireplace into the wall opening. Use the screws provided to fasten the fireplace to your framing studs.

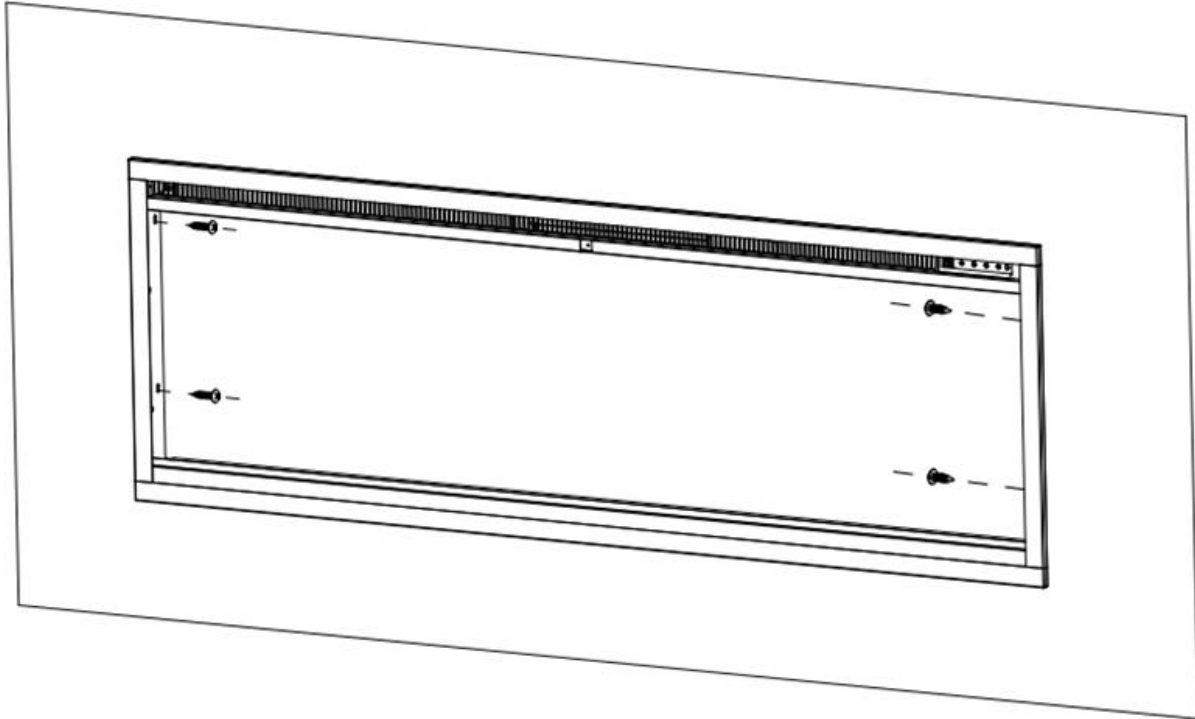

6. Once the fireplace is secure, reinstall the 2 brackets removed in step 4.

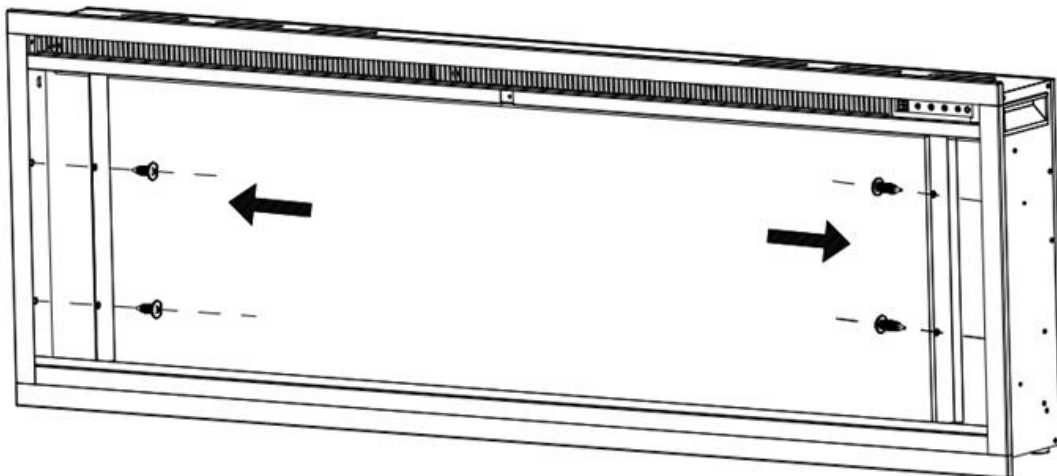

The fireplace is now ready to have the crystal embers and drift wood logs placed inside of the fireplace.

## Installing the Crystal Embers and Drift Wood Logs

Once the fireplace is installed in the wall, place crystal embers or drift wood in the fireplace.

### Crystal Ember Installation

1. Remove the log set from the fireplace. Once the log set is removed, a plastic strip will be beneath the log set.

*Note: If the LED lights can clearly be seen, then the crystal strip is missing. Please call customer service for a replacement if missing.*



2. Carefully, place crystal embers on plastic strip as illustrated in the picture to the right. Apply an even layer from side to side.



### Installing the Drift Wood Logs

1. Place drift wood log pieces in the fireplace as shown below.



## Reinstalling the Glass Panel

Once completed installing crystal embers or fire log, you are now ready to reinstall the glass panel.

1. Fit the bottom of the glass panel into the slot in the bottom of the firebox (A). Once in place, push the top of the glass panel back toward the firebox (B).

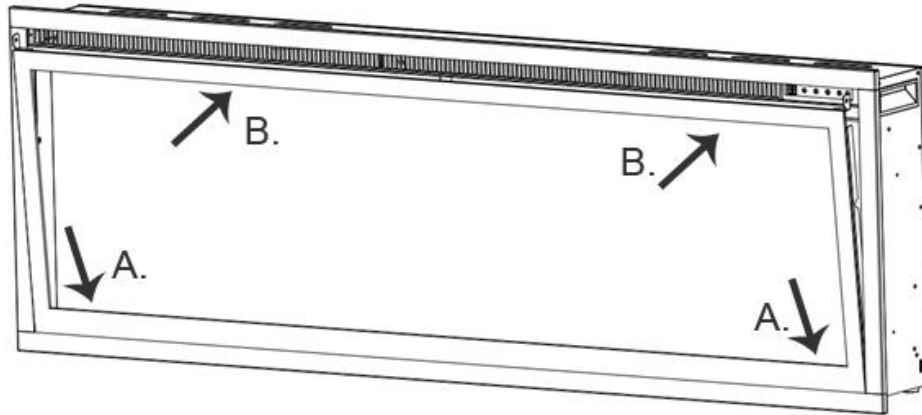

2. Once the glass panel is in place, secure the glass panel to the firebox using the 2 screws removed in Remove the Glass Panel section.

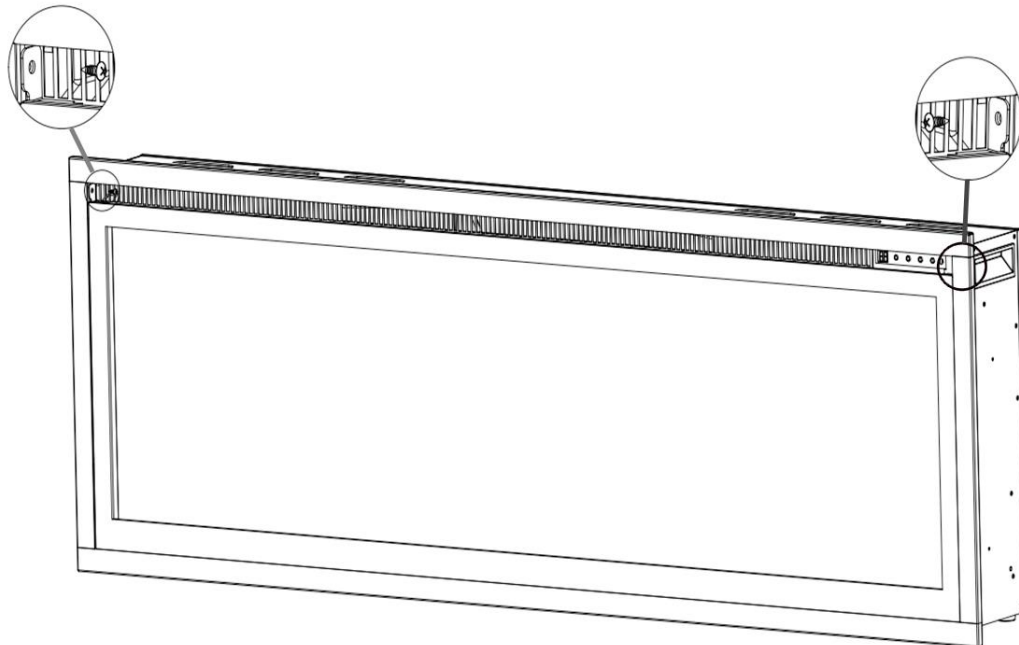

Your Sideline® Elite Series fireplace is now ready for use!

## Wall Mounted Installation

- Due to many different finish materials used on walls, it is highly recommended that you consult your local builder before you install this fireplace on the wall.
- Select a location that is not prone to moisture and is located at least 36” away from combustible materials such as curtains, drapes, furniture, bedding, or other combustible materials.

### Instructions

1. Select a location that is not prone to moisture and is located at least 36” away from combustible materials, such as curtains, drapes, furniture, bedding, paper, etc.
2. With glass panel removed (see p.11 for instructions on removing glass panel), have two people hold the fireplace against the wall to determine the final location.
3. Place the unit face down on a soft, non-abrasive surface. Remove the bracket from the back of the unit by removing the screws holding the bracket to the back of the fireplace.

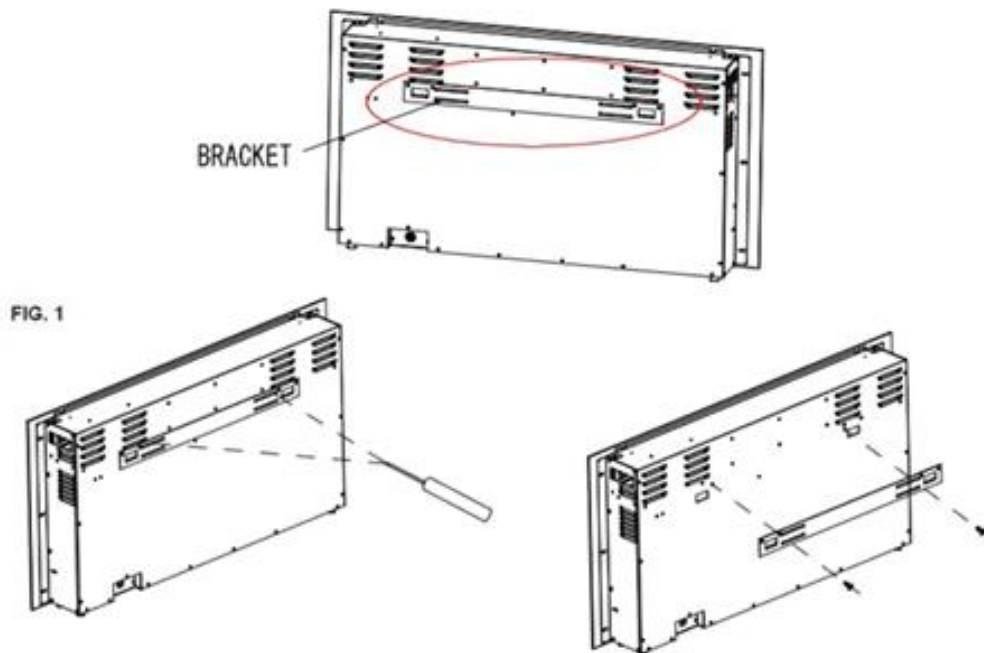

Wall Bracket Removal (1 bracket)

## Wall Mounted Installation – cont.

4. Mark location of bracket on wall and then mount the bracket to the wall using the supplied screws and dry wall anchors. The hooks in the bracket MUST be pointed away from the wall, upward, and level.

**Note: Mount bracket to at least 2 studs. If 2 studs cannot be used, ensure that the supplied dry wall anchors are used to affix the bracket to the wall and the bracket is adequately secured before moving to the next step.**

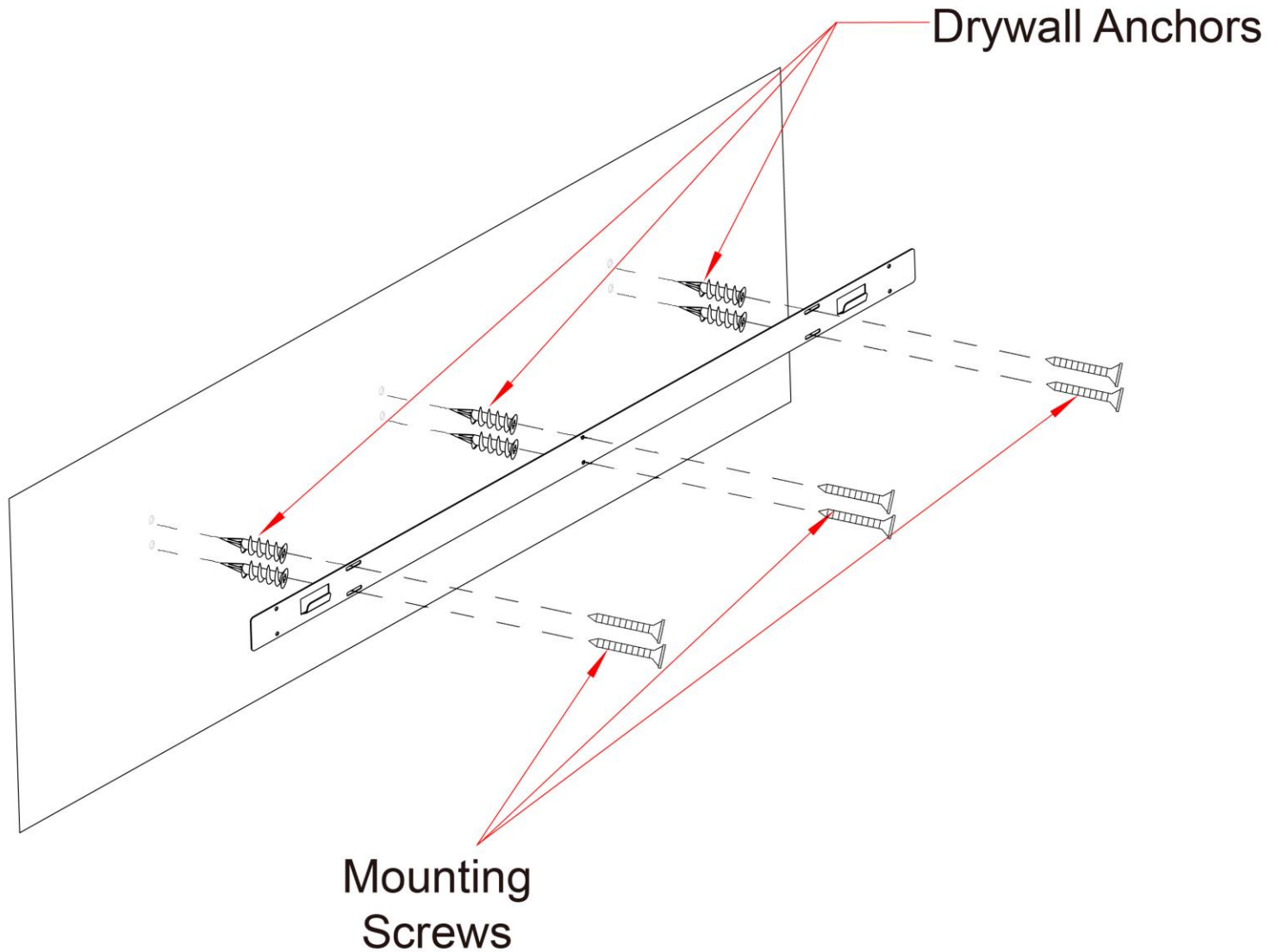

## Wall Mounted Installation – cont.

5. With the wall mounting bracket installed, have 2 people lift the fireplace up and insert the 2 hooks on the bracket into the back of the fireplace. The 2 hooks on the mounting bracket will line up with the 2 holes on the back of the fireplace. Once aligned, the hooks will insert into the holes in the back of the fireplace and lock in the down position.

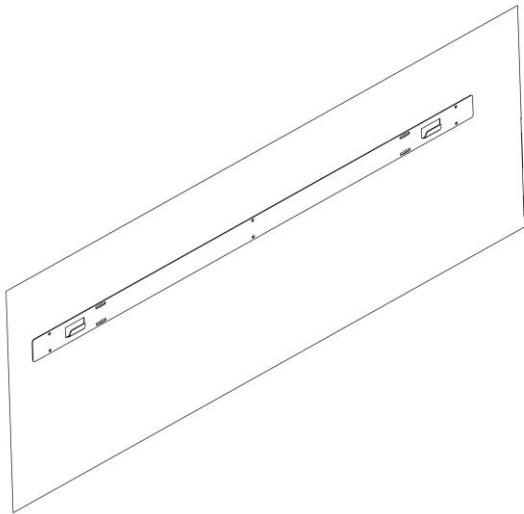

Mounting bracket installed on wall

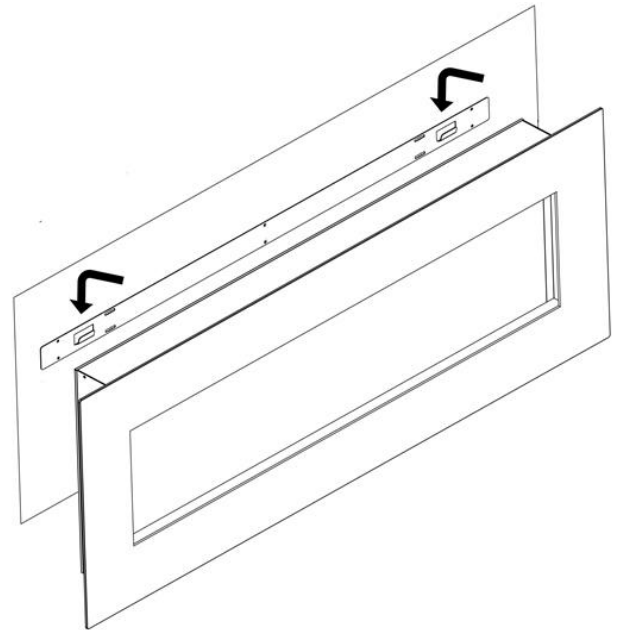

Hang fireplace on mounting bracket hooks

6. Check the fireplace for stability, ensuring that the bracket will not pull free from the wall. Once satisfied, install crystal embers/fire log and reinstall glass panel.



## Operating Fireplace

Once the fireplace has been plugged into a grounded outlet, the fireplace is now ready for operation. Ensure that the house circuit breakers for the power supply are turned on.

### Power

Plug the power cable into a 110v 15 amp grounded outlet. Make sure the outlet is in good condition and that the plug is not loose. **NEVER** exceed the maximum amperage for the circuit. **DO NOT** plug other appliances into the same circuit.

### Methods of Operation

This electric fireplace can be operated by the CONTROL PANEL, located in the upper righthand corner of the fireplace, or by the WIRELESS REMOTE CONTROL. The operation and functions of both methods are the same.

#### Control Panel

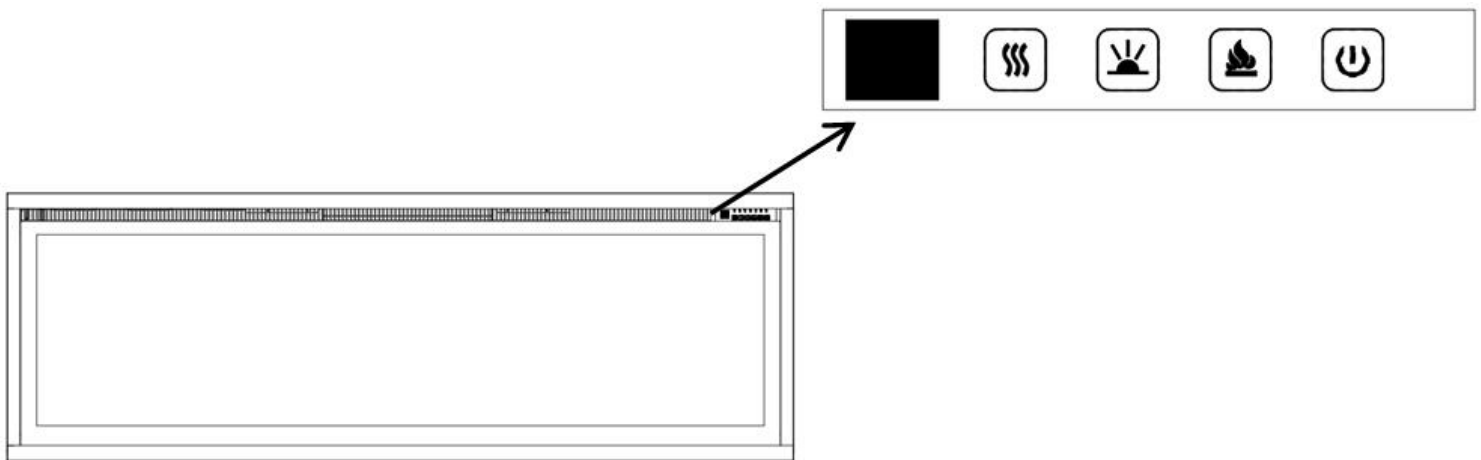



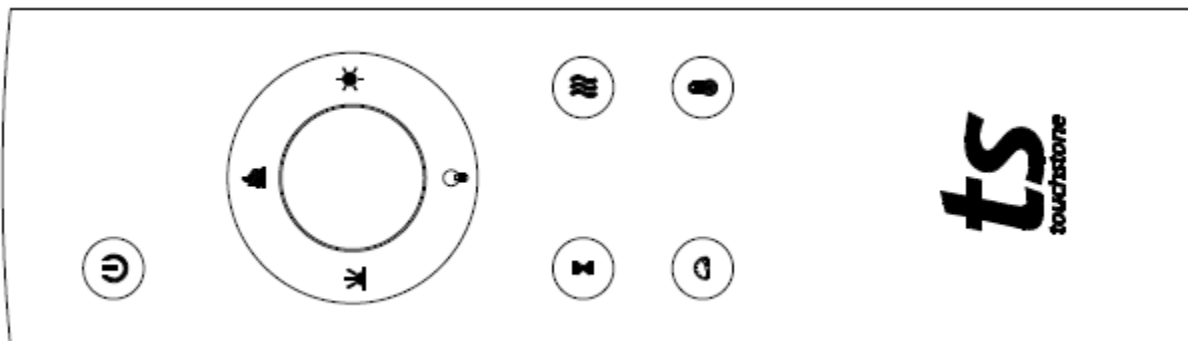

#### Wireless Remote Control







**Method of Operation – cont.**

**Control Panel Functions**

BUTTON	FUNCTION	ACTION & INDICATION
 <b>POWER</b>	<p><b>ON:</b> Enables control panel functions and remote control. Turns on flame effect.</p> <p><b>OFF:</b> Disables control panel functions and remote control. Turns off flame effect.</p>	<ol style="list-style-type: none"> <li><b>Press once.</b> Indicator light turns on. Power turns on. All functions enabled.</li> <li><b>Press again.</b> Flame effect turns off. Unit goes to standby. All functions turn off.</li> </ol>
 <b>FLAME COLOR</b>	<p><b>Flame Color button:</b> Changes the color flame effect.</p> <p><b>NOTE:</b> Color effect stays on until power button is turned off. Color flame effect must be on for heater to turn on.</p> <p><b>NOTE:</b> The fireplace will remember the last flame color used when the fireplace is turned off. Unplugging the fireplace will reset the color to the default color.</p>	<ol style="list-style-type: none"> <li><b>Press once</b> to change the flame color.</li> <li><b>Press again</b> until desired setting is reached. There is a total of 6 different flame color combinations.</li> </ol>
 <b>EMBER LIGHTS</b>	<p><b>LED Ember Light button:</b> Changes the color of the embers below the crystals/logs.</p> <p><b>NOTE:</b> Ember color effect stays on until power button is turned off.</p> <p><b>NOTE:</b> The fireplace will remember the last flame color used when the fireplace is turned off. Unplugging the fireplace will reset the color to the default color.</p>	<ol style="list-style-type: none"> <li><b>Press once</b> to change the ember color.</li> <li><b>Press again</b> until desired setting is reached. There is a total of 10 different ember color combinations.</li> <li><b>Auto-cycle function:</b> When pressing with the 11<sup>th</sup> time, the LED ember light will do auto-cycling (<b>NOTE: It will take 15 seconds to switch between colors.</b>)</li> </ol>
 <b>HEATER</b>	<p><b>Heater button:</b> Turns heater on and off.</p> <p><b>NOTE:</b> The heater only works when the flame effect is ON. If the flame effect is OFF, the heater will not turn on.</p> <p><b>NOTE:</b> To prevent overheating, the heater blows cool air for 10 seconds before the heater turns on, and after it turns off.</p>	<ol style="list-style-type: none"> <li><b>Press once.</b> Indicator lights up. Fan blows cool air for 10 seconds. Low heater turns on and blows warm air.</li> <li><b>Press again.</b> Indicator lights up. High heater turns on and blows hot air.</li> <li><b>Press again.</b> Heaters turn off. The fan blows cool air for 10 seconds and then turns off.</li> </ol>





## Method of Operation – cont.

### Wireless Remote Control Functions

BUTTON	FUNCTION	ACTION & INDICATION																																																				
 <b>POWER</b>	<p><b>ON:</b> Enables control panel functions and remote control. Turns on flame effect.</p> <p><b>OFF:</b> Disables control panel functions and remote control. Turns off flame effect.</p>	<ol style="list-style-type: none"> <li><b>Press once.</b> Indicator light turns on. Power turns on. All functions enabled.</li> <li><b>Press again.</b> Flame effect turns off. Unit goes to standby. All functions turn off.</li> </ol>																																																				
 <b>TEMP</b>	<ol style="list-style-type: none"> <li><b>Press once:</b> Touch panel indicator activates</li> <li><b>Press again</b> until desired temperature is reached. Digital display shows setting circles as below:</li> </ol> <table border="1" data-bbox="280 653 1515 821"> <tr> <td>NO</td><td>0</td><td>1</td><td>2</td><td>3</td><td>4</td><td>5</td><td>6</td><td>7</td><td>8</td><td>9</td><td>10</td><td>N</td> </tr> <tr> <td>°C</td><td>20</td><td>21</td><td>22</td><td>23</td><td>24</td><td>25</td><td>26</td><td>27</td><td>28</td><td>29</td><td>30</td><td>C</td> </tr> <tr> <td>°F</td><td>68</td><td>70</td><td>72</td><td>74</td><td>76</td><td>78</td><td>80</td><td>82</td><td>84</td><td>86</td><td>88</td><td>F</td> </tr> <tr> <td></td><td>69</td><td>71</td><td>73</td><td>75</td><td>77</td><td>79</td><td>81</td><td>83</td><td>85</td><td>87</td><td></td><td></td> </tr> </table> <p><b>NOTE:</b> Press and HOLD the button for 5 seconds to switch between °C and °F.</p> <p><b>NOTE:</b> If the room temperature is ABOVE the temperature listed on the display, the heater will not turn ON. The room temperature needs to be below the temperature listed on the display for the heater to turn ON.</p>	NO	0	1	2	3	4	5	6	7	8	9	10	N	°C	20	21	22	23	24	25	26	27	28	29	30	C	°F	68	70	72	74	76	78	80	82	84	86	88	F		69	71	73	75	77	79	81	83	85	87			
NO	0	1	2	3	4	5	6	7	8	9	10	N																																										
°C	20	21	22	23	24	25	26	27	28	29	30	C																																										
°F	68	70	72	74	76	78	80	82	84	86	88	F																																										
	69	71	73	75	77	79	81	83	85	87																																												
 <b>HEATER</b>	<p><b>Heater button:</b> Turns heater on and off.</p> <p><b>NOTE:</b> The heater only works when the flame effect is ON. If the flame effect is OFF, the heater will not turn on.</p> <p><b>NOTE:</b> To prevent overheating, the heater blows cool air for 10 seconds before the heater turns on, and after it turns off.</p>	<ol style="list-style-type: none"> <li><b>Press once</b> and the indicator lights up. Fan blows cool air for 10 seconds. Low heater turns on and blows warm air.</li> <li><b>Press again</b> and the indicator lights up. High heater turns on and blows hot air.</li> <li><b>Press again</b> and the heater turns OFF. The fan blows cool air for 10 seconds and then turns off.</li> </ol>																																																				
 <b>SPEED</b>	<p><b>Flame Speed button:</b> Controls the speed of the flame. There are 3 flame speed settings: 01 (slowest), 02 (Medium), 03 (fastest).</p>	<ol style="list-style-type: none"> <li><b>Press once</b> to change the flame speed.</li> <li><b>Press again</b> until desired setting is reached. Display shows the setting.</li> </ol> <p><b>NOTE:</b> The Default setting is 02 (medium speed)</p>																																																				

**Method of Operation – cont.**

**Wireless Remote Control Functions – cont.**

BUTTON	FUNCTION	ACTION & INDICATION
 <b>TIMER</b>	<p><b>Timer button:</b> Controls timer settings to turn off fireplace at selected time.                      Settings range from 1 hour to 8 hours.</p>	<ol style="list-style-type: none"> <li><b>Press once</b> and the indicator lights up. Timer is set to 1 hour.</li> <li><b>Press again until desired setting is reached.</b> Indicator lights will show the timer setting.</li> </ol>
 <b>FLAME BRIGHTNESS</b>	<p><b>Flame button:</b> Each press of the flame button makes flame effect dimmer and brighter.  <b>NOTE:</b> Flame effect stays on until power button is turned off. Flame effect must be on for heater to turn on.</p>	<ol style="list-style-type: none"> <li><b>Press once</b> to change the flame brightness.</li> <li><b>Press again</b> until desired flame brightness setting is reached.</li> </ol>
 <b>FLAME COLOR</b>	<p><b>Flame Color button:</b> Changes the color flame effect.  <b>NOTE:</b> Color effect stays on until power button is turned off. Color flame effect must be on for heater to turn on.  <b>NOTE:</b> The fireplace will remember the last flame color used when the fireplace is turned off. Unplugging the fireplace will reset the color to the default color.</p>	<ol style="list-style-type: none"> <li><b>Press once</b> to change the flame color.</li> <li><b>Press again</b> until desired setting is reached. There is a total of 6 different flame color combinations.</li> </ol>
 <b>EMBER LIGHTS</b>	<p><b>LED Ember light button:</b> Changes the color of the embers below the crystals/logs.  <b>NOTE:</b> Ember color effect stays on until power button is turned off.  <b>NOTE:</b> The fireplace will remember the last flame color used when the fireplace is turned off. Unplugging the fireplace will reset the color to the default color.</p>	<ol style="list-style-type: none"> <li><b>Press once</b> to change the ember color.</li> <li><b>Press again</b> until desired setting is reached. There is a total of 10 different ember color combinations.</li> <li><b>Auto-cycle function:</b> When pressing with the 11<sup>th</sup> time, the LED ember light will do auto-cycling (<b>NOTE: It will take 15 seconds to switch between colors.</b>)</li> </ol>
 <b>EMBER BRIGHTNESS</b>	<p><b>LED Ember light brightness button:</b> Makes the LED ember lights on bottom effect change brightness.  <b>NOTE:</b> LED Ember light brightness effect stays on until power button is turned off.</p>	<ol style="list-style-type: none"> <li><b>Press once.</b> LED ember light color changes brightness.</li> <li><b>Press again</b> until desired setting is reached. In total 5 levels.                      From L1 - L2 - L3 - L4 - L5</li> </ol>

---

## **Remote Control Operation**

- This remote control uses 3 AAA batteries (**Included**).
- Instructions for battery installation are located on the remote control battery compartment door.
- To improve operation of the remote control, aim the remote control at the front of the fireplace. **DO NOT PRESS the buttons too quickly.** Give the unit time to respond to each command.
- **NOTICE: NEVER** dispose of batteries in fire. Failure to observe this precaution **may result in an explosion.** Dispose of batteries at your local hazardous material processing center.

## **Temperature Limiting Control**

This heater is equipped with a Temperature Limiting Control. Should the heater reach an unsafe temperature, the heater will automatically **TURN OFF**. To reset, please do the following:

1. Unplug the power cord from the outlet.
2. Turn ON/OFF switch on the CONTROL PANEL to OFF. Wait 5 minutes for fireplace to cool down.
3. Inspect the fireplace to make sure no vents are blocked or clogged with dust or lint. If they are, use a vacuum to clean the vent areas.
4. With the POWER switch in the OFF position, plug the power cord back into the outlet.
5. If the problem continues, have your outlet and wiring inspected by a professional. If the outlet is OK, please contact our customer support department at 800-215-1990.

---

## Care and Maintenance

### *Cleaning*

- **ALWAYS** turn the heater **OFF** and unplug the power cord from the outlet before cleaning, performing maintenance, or moving the fireplace. Failure to do so could result in electric shock, fire, or personal injury.
- **NEVER** immerse in water or spray with water. Doing so could result in electric shock, fire, or personal injury.

### **Metal:**

- Buff using a soft cloth, slightly dampened with citrus oil-based product.
- **DO NOT** use brass polish or household cleaners, as these products will damage the metal trim.

### **Glass:**

- Use a good quality glass cleaner sprayed onto a cloth or towel. Dry thoroughly with a paper towel or lint-free cloth.
- **NEVER** use abrasive cleansers, liquid sprays, or any cleaner that could scratch the surface.

### **Vents:**

- Use a vacuum or duster to remove dust and dirt from the heater and vent areas.

### **Plastic:**

- Wipe gently with a slightly damp cloth and a mild solution of dish soap and warm water.
- **NEVER** use abrasive cleansers, liquid sprays, or any cleaner that could scratch the surface.

### *Maintenance*

- **RISK OF ELECTRIC SHOCK! DO NOT OPEN any panels. No user-serviceable parts inside!**
- **ALWAYS** turn the heater **OFF** and unplug the power cord from the outlet before cleaning, performing maintenance, or moving the fireplace. Failure to do so could result in electric shock, fire, or personal injury.

### **Electrical and Moving Parts:**

- The fan motors are lubricated at the factory and will not require lubrication.
- Electrical components are integrated in the fireplace and are not serviceable by the customer.

### **Storage:**

- Store fireplace in a clean, dry place when not in use.

## Warranty

Touchstone Home Products®, Inc warrants our electric fireplaces to be free of defects in material and workmanship for one year from date of purchase. Touchstone will repair or replace any fireplace or fireplace part that is deemed defective or becomes defective during normal use within one year after the date of purchase.

Electrical components, such as fan motor, heater motor, control board, remote control, and control panel are covered under warranty for one year from date of purchase. Touchstone Home Products® will provide replacement parts free of charge during the first year of the warranty.

Replacement parts and fireplace units are covered under a 90-day warranty or the remainder of the original one year manufacturer's warranty from original date of purchase, whichever is greater.

Touchstone Home Products®, Inc does not warrant its products against damage caused by third parties.

Touchstone Home Products®, Inc does not cover damages caused by misuse, alterations, accident, lack of maintenance, abuse or neglect. Parts installed from other manufacturers will void this warranty.

The warranty does not cover paint scratches, cosmetic blemishes, dents, corrosion, or other normal wear and tear associated with the fireplace. Damage to fireplace or other components due to water, weather damage, long periods of dampness, condensation, damaging chemicals or cleaners are not covered under warranty.

This warranty does not cover breakage of fireplace glass panel.

Touchstone Home Products® will not be responsible for installation, labor, or any other expenses related to the reinstallation of a warranted part, and such expenses are not covered under warranty.

Extended warranty coverage for the fireplace is available by contacting Touchstone Home Products® directly at 1-800-215-1990.

 **CALL US FIRST!**   
**DO NOT RETURN TO STORE.**

For immediate help with assembly, product information,  
or if your product arrives damaged, call our toll-free number at

**800-215-1990**

or email:

[customerservice@thpus.com](mailto:customerservice@thpus.com)

**Our staff is ready to provide assistance.**

Affix Serial Number Label Here