

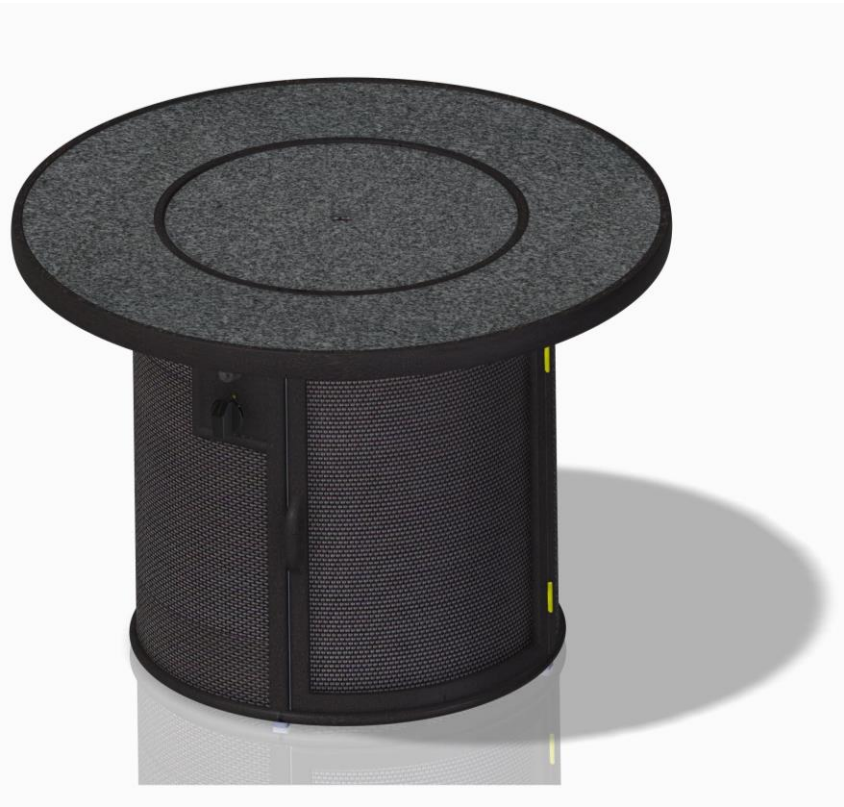

THE OUTDOOR
GREATROOM
COMPANY

Stonefire Fire Pit Table

Installation Instructions for SF-32-K



IMPORTANT

Please consult your Crystal Fire instruction manual for detailed instructions and important information related to the burner installation including: lighting and operating instructions, safety information, and proper tightening of connections with two wrenches.

DO NOT ATTEMPT TO INSTALL CRYSTAL FIRE BURNER WITHOUT FIRST CONSULTING THE CRYSTAL FIRE OWNER'S MANUAL.

Contents

Required Tools.....	3
Included with your Fire Pit.....	4
Assembly Instructions.....	5
Gas Connections.....	7
Igniter Installation.....	9
Glass Installation.....	10
Position Your Tank.....	11

Required Tools



- Utility Knife

To cut and remove packaging



- 2 Open Ended Wrenches

To secure gas connections



- Leather Gloves

To protect hands from glass and sharp edges during install



- One AAA Battery (not included)

Required for electric spark igniter installation



- Phillips Screwdriver

To attach mounting screws to control panel



- **Two people are required for this installation**

Included with your Fire Pit

Bolt Cap



[X4]

Clear Silicone Pads



[X4]

Gas Valve Kit

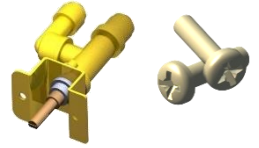

Gas Valve

Mounting screws [X2]

Bolt A [X4]



M6X20

M6 Allen Wrench



[X1]



Control knob [X1]

Top [X1]



Glass Cover [X1]



Base [X1]



Assembly Instructions

1. Unpack all the contents from the box and remove the individual packaging from each component.
2. Carefully lay the Top, with underside facing upwards, on a soft and flat surface.
3. Using the M6 Allen Wrench, attach Bolt A (x4) to securely fasten the Top to the Base.



4. Do a final tightening on the bolts you have installed in your fire pit. Then, with the help of another person, turn the table right side up.

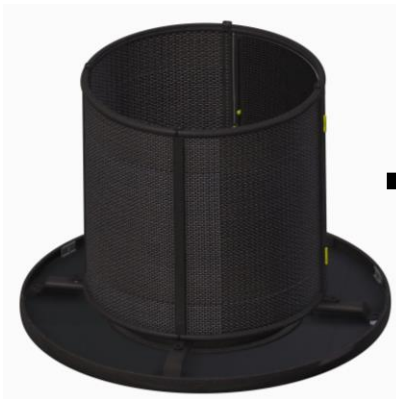

5. Hold the Gas Valve in place from behind the control panel as shown while inserting the two included Mounting Screws. Use a Phillips screwdriver to fasten.

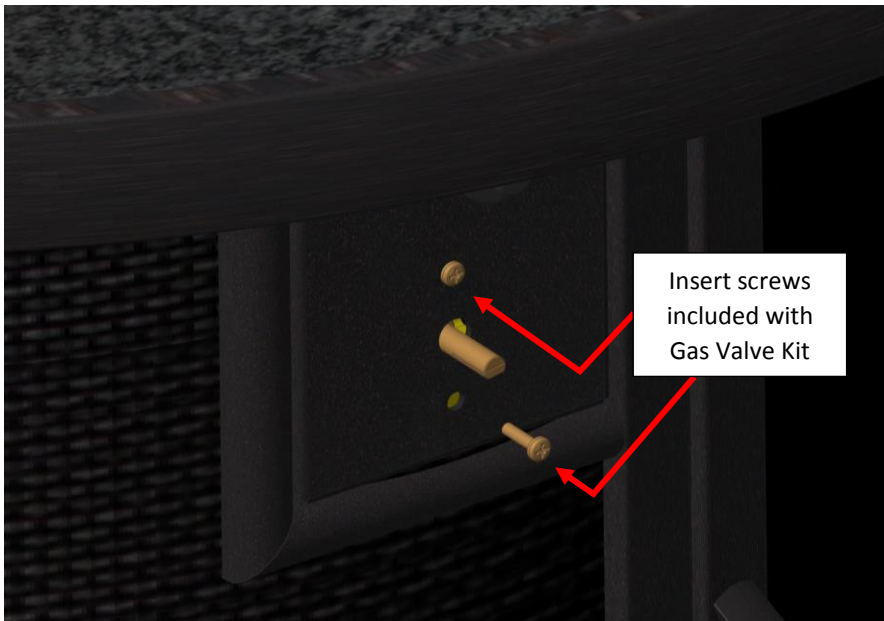

6. Attach Control Knob by pressing on to the valve stem.



Gas Connections

Read and understand your Crystal Fire owner's manual before beginning burner hookups or using the device.

Do not use Teflon tape or pipe dope on flare fittings.

1. Reach inside the burner cut-out and attach natural gas supply line using a 3/8" flare fitting, or attach the included black rubber propane hose and regulator to the bottom fitting of the control valve.

TIGHTEN SECURELY WITH A WRENCH

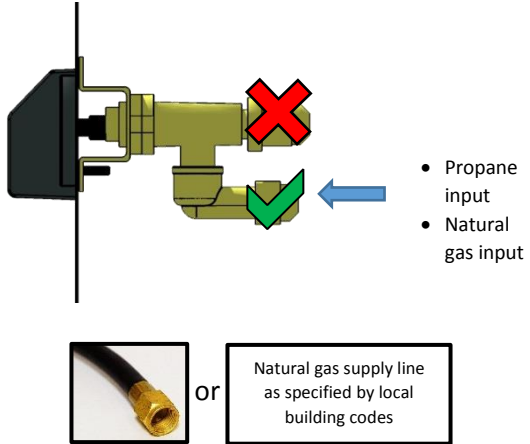
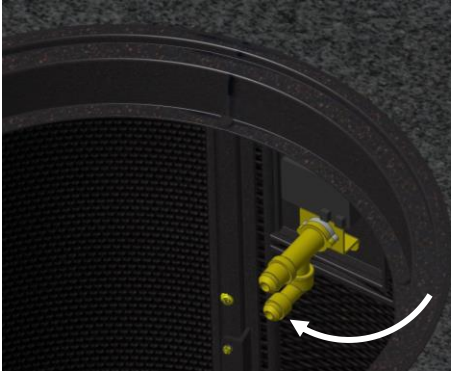

2. Lay the burner upside down on a flat, soft surface to avoid scratching the polished metal. Ensure the correct orifice is installed for the fuel type you are using (see Crystal Fire user manual included with burner for orifice sizing information). Attach the included metal flex hose to the burner.

TIGHTEN SECURELY WITH TWO WRENCHES

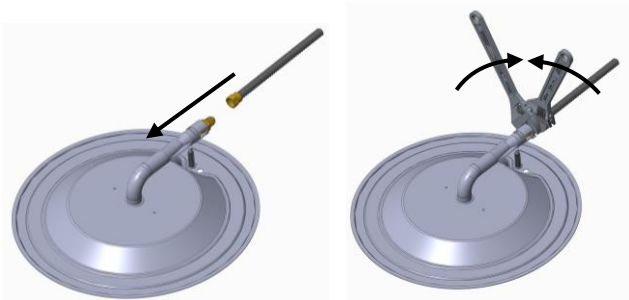

3. Set Burner into the fire pit base as shown below.

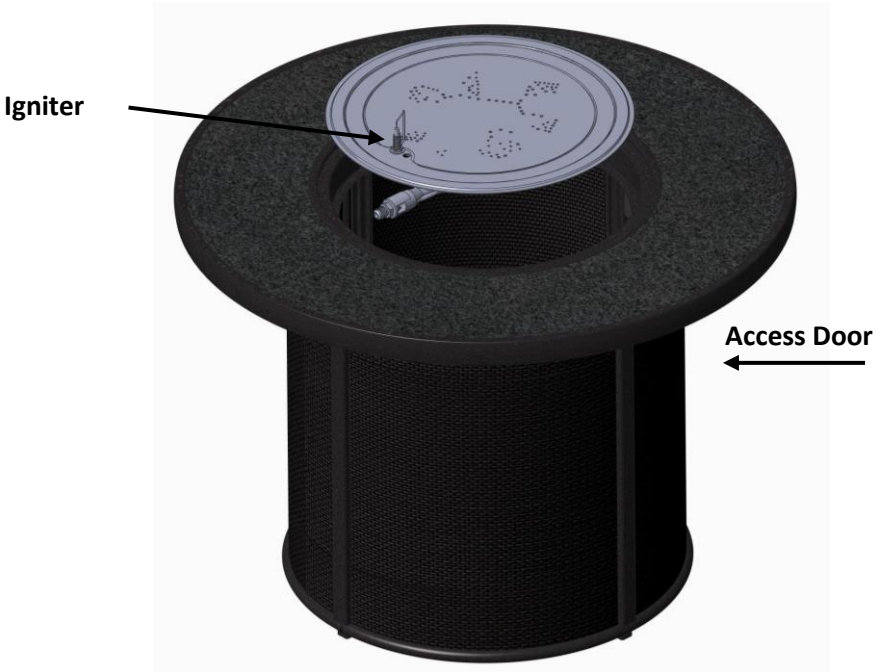

4. Attach flex line from the burner to gas valve as shown below.

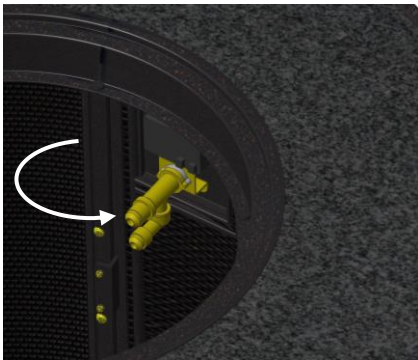

TIGHTEN CONNECTION
SECURELY WITH WRENCH

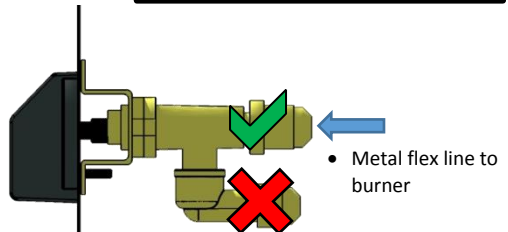

Igniter Installation

1. Make sure the valve is in the OFF position before beginning.
2. Install sparker as shown, using a AAA battery (not included). Negative end should be placed inside the CF-SPARKER, positive end outside of the CF-SPARKER.

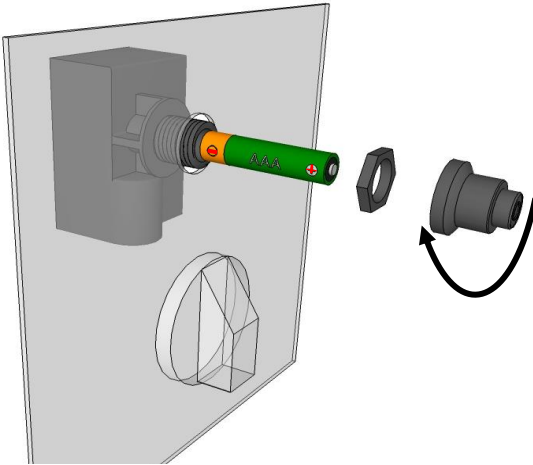
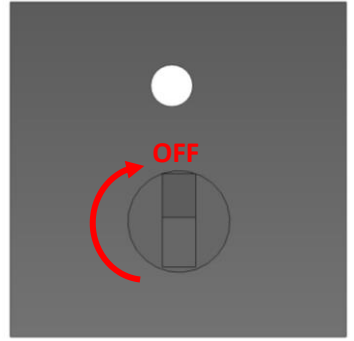

Sparker will not operate correctly without an ignition **and** ground wire attached.

- Plug both **BLACK** wires hanging from the burner into the back of the sparker box.

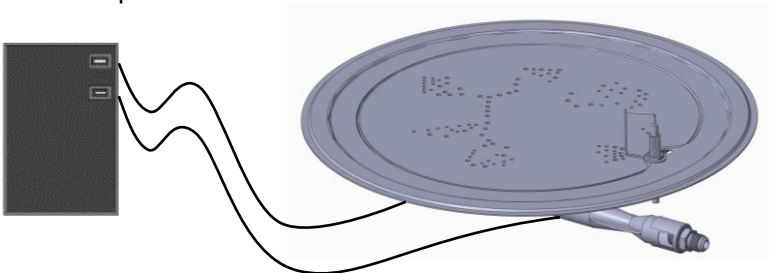

- Test system by pushing the button on the igniter. Consult the troubleshooting section of the Crystal Fire Owner's Manual, if the spark is weak, intermittent, or not present. 9

Glass Installation

1. Scatter all of the included Glass Beads evenly onto burner surface.
DO NOT OPERATE CRYSTAL FIRE BURNER WITHOUT GLASS BEADS OR OTHER DECORATIVE MEDIA PRESENT



2. Attach the Clear Silicone Pads (x4) to the **bottom** of your Glass Cover. Space the pads evenly apart on the outer most edge of the cover.
3. Place the Glass Cover on top of the burner, with silicone pads facing downwards.

DO NOT OPERATE CRYSTAL FIRE BURNER WITH GLASS COVER IN PLACE

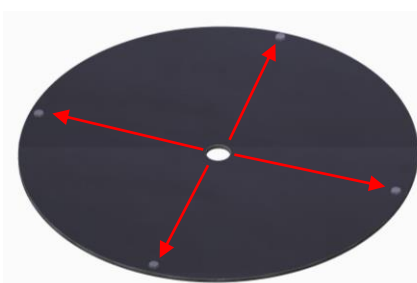

After installing sparker and making gas connections, verify that all connections are tight and that no leaks are present using a solution of soapy water or a commercially available leak-check solution.

Position Your Tank (if applicable)

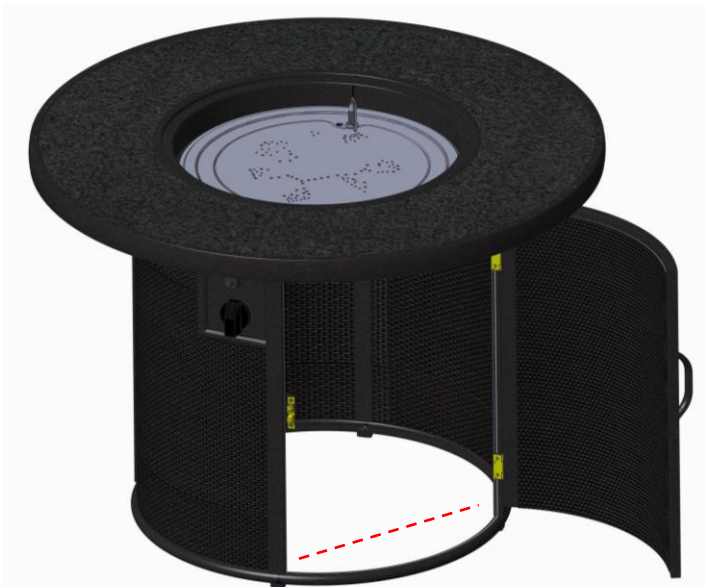

1. Connect the propane hose/regulator to the propane tank and hand tighten (DO NOT USE A WRENCH) and slide the propane tank past the dotted line to ensure the Access Door closes properly.
2. With the tank inside, ensure that no hoses, wires, or any other components are kinked or touching the burner pan.

IMPORTANT

Please consult your Crystal Fire instruction manual for detailed instructions and important information related to the burner installation including: lighting and operating instructions, safety information, and proper tightening of connections with two wrenches.

DO NOT ATTEMPT TO INSTALL CRYSTAL FIRE BURNER WITHOUT FIRST CONSULTING THE CRYSTAL FIRE OWNER'S MANUAL.

WARNING

After consulting the manual and following instructions, remember; before operating, all gas connections must be fully checked for leaks

Warranty: Fire pit tables are covered under a 1-year manufacturer's warranty. Please visit <http://www.outdoorrooms.com/warranty-form/> to register your product.



WARNING: This product can expose you to chemicals including Carbon Monoxide and Benzene which are known to the State of California to cause cancer or birth defects or reproductive harm. For more information, visit www.P65Warnings.ca.gov

