

# WALL MOUNTED STUDIO SUITE DISPLAY FOR THE LANDSCAPE PRO MULTI FIREPLACE

Owner/Installation Guide

Covers Part Numbers:

**WMC-xxLPM-xxx**

44-56-68-80

CS-DW-RTF-WW



## HOW TO INSTALL VIDEO



Digital Copy

# Assembly, Parts & Hardware List

## What's in the Box

- Instruction guide



- Power Cord



- Cabinet mount brackets P/N: 02-00595

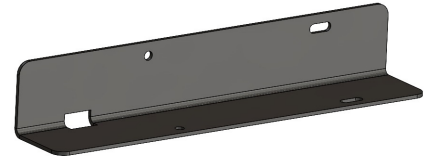

- Top/Bottom LPM cabinet suite

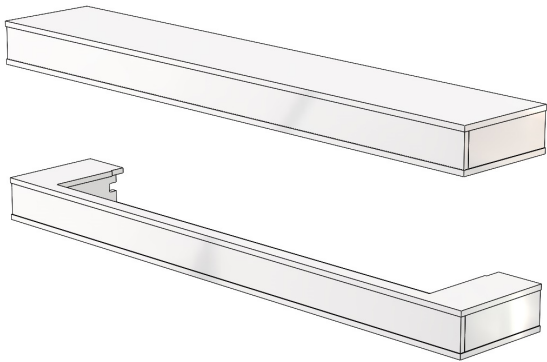

- Matching side pieces



- WMC spacers (Not applicable to all fireplaces).



- Size-specific wall mount bracket

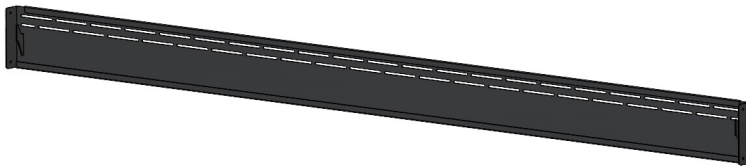

- Hardware kit: Image is example only.

#8x1" Screws



#8x1-5/8" Screws



#Hollow wall anchors



#8x3/4" Self-drilling screws



#8x1" Screws



# Assembly, Parts & Hardware List

Verify you have the correct suite for your fireplace by checking the part number.

**WMC-xxLPM-xxx**

Size of the fireplace  
44-56-68-80

Finish of the Suite  
CS-DW-RTF-WW

## EXAMPLE OF FINISH

(RTF is a ready-to-paint white primer finish, not shown.)



# Installation and Assembly

## Installed suite dimensions

- 44in LPM Version = 58.5" W x 28" H x 14.5" D.
- 56in LPM Version = 70.5" W x 28" H x 14.5" D.
- 68in LPM Version = 82.5" W x 28" H x 14.5" D.
- 80in LPM Version = 94.5" W x 28" H x 14.5" D.



- 1 Select a suitable location for your installation while taking into consideration the type of installation, the running of your electrical, and the overall size of the finished installation.

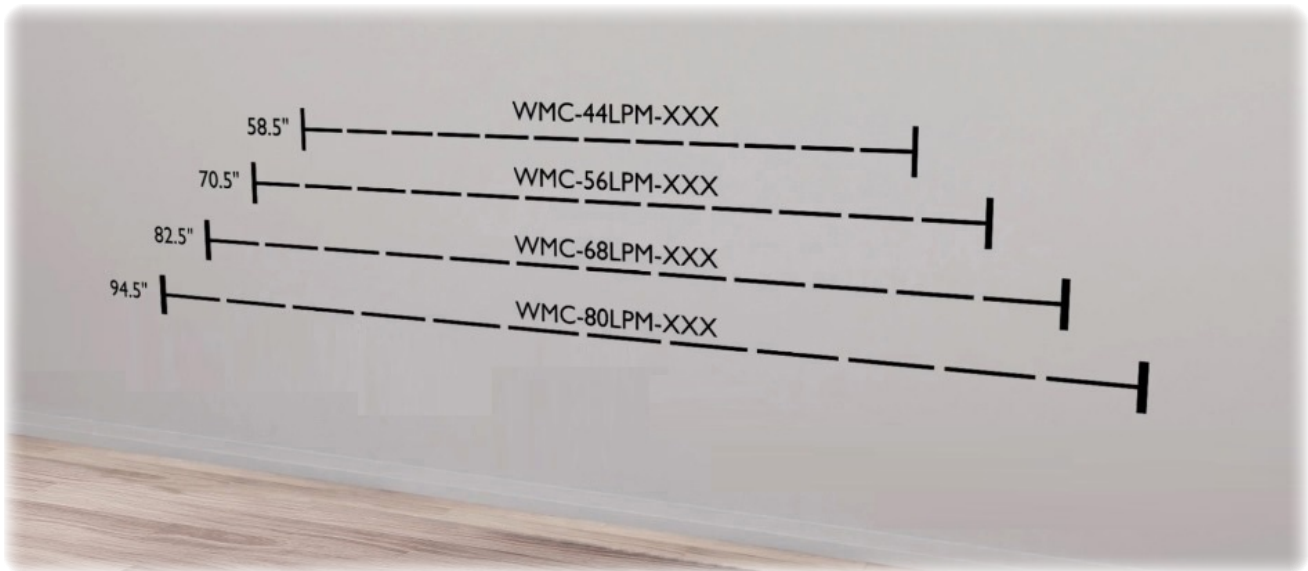

- 2 Unpack and separate the contents of the Wall mounted Studio Suites for the Landscape Pro Multi. Reference page 2 to verify contents. For any content that is missing, contact Modern Flames customer service at 1-877-246-9353 or via email at [customerservice@modernflames.com](mailto:customerservice@modernflames.com).

# Installation and Assembly

- 3 Locate the studs on the wall to install size-specific wall mount bracket. You must be able to secure a minimum of 2 studs for proper installation and as close to the end of the bracket as possible. The hollow wall anchors provided are only for additional support between studs.



- 4 To assist in locating the fireplace bracket on the wall, first install the bracket onto the fireplace. Once installed, measure from the top of the bracket to the top of the fireplace. After locating the top placement of the fireplace on the wall, measure down using the previous measurement and mark the location. This will be the top location of the bracket for mounting purposes. With the wall mount bracket removed from the fireplace, press it against the wall and line it up with the previous location mark. Ensure to level the bracket and mark any slots that will be used for securing the bracket to the wall.

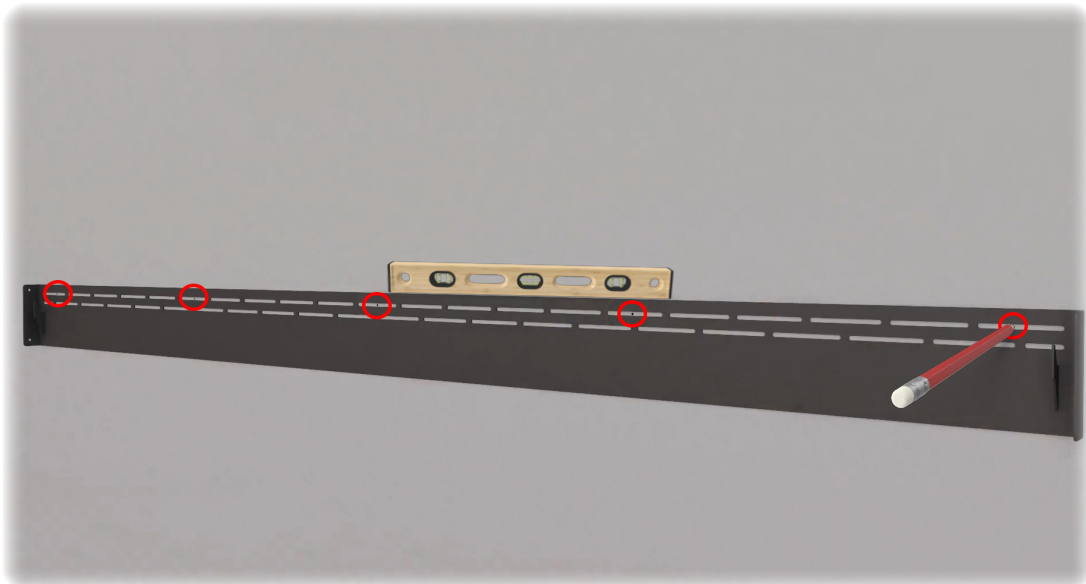

# Installation and Assembly

- 5 Align the bracket with the marks previously made and mount the bracket to the wall. Note:
- It is recommended to pre-drill mounting holes before installation with a  $7/64$ " drill bit (not included).
  - The hollow wall anchors will need to be installed before the wall mounting bracket.
  - It is recommended that the anchors be installed with a Phillips tip screwdriver for proper installation.

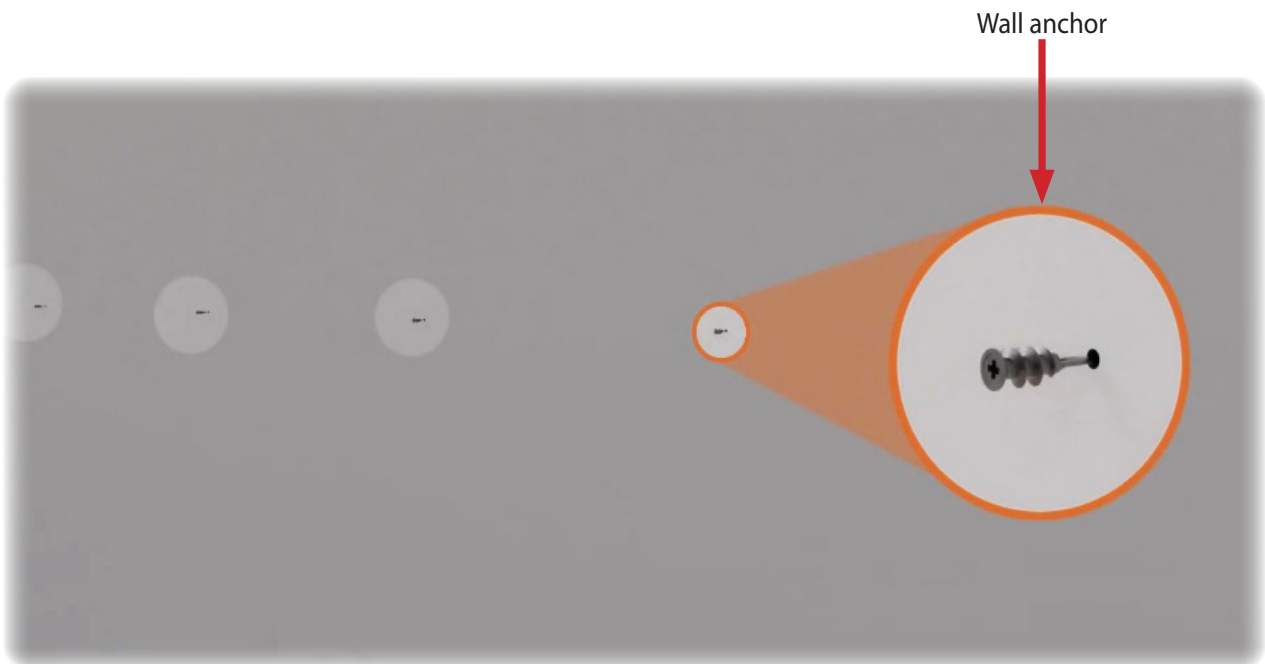
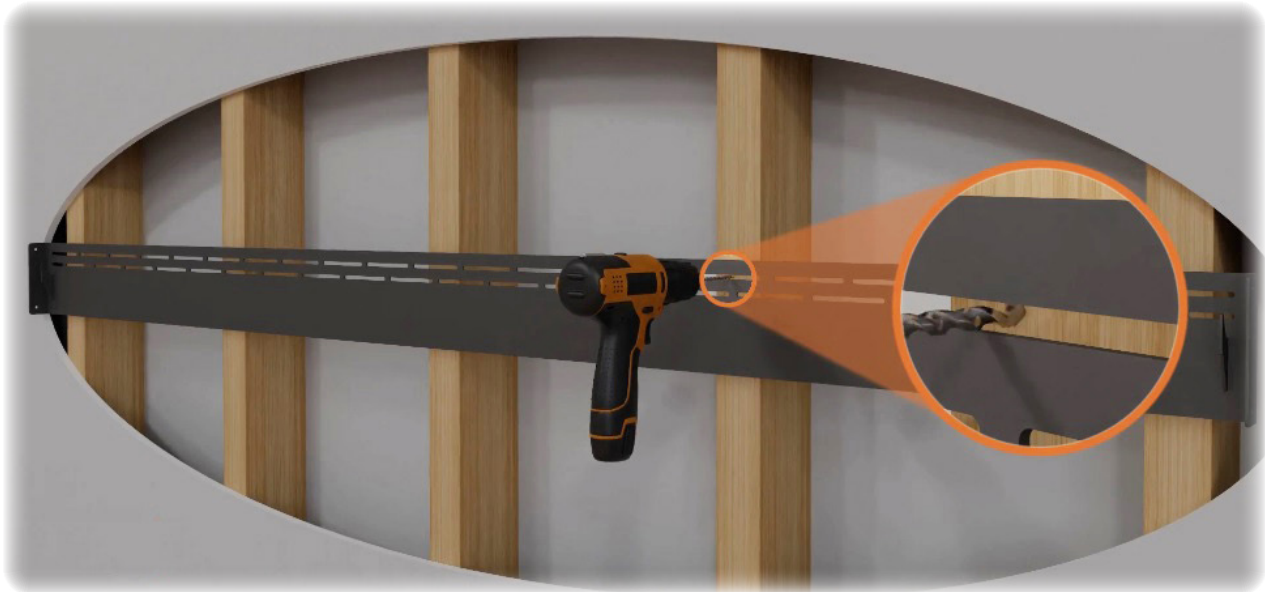

# Installation and Assembly

- 6 Run a hardwire line or locate an outlet 2.25" from the right side of the bracket to the center of the outlet. The space where the outlet can be installed measures: 4"W x 4.5" H. Outlet position can be horizontal or vertical.

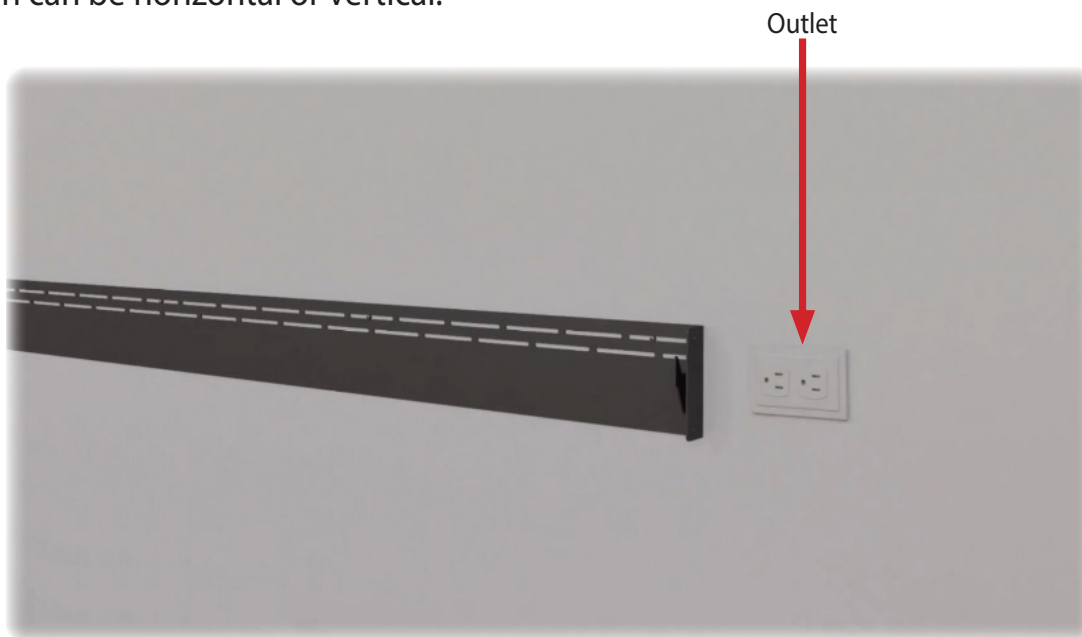

- 7 Depending on your fireplace, you may need to install two (x2) spacers, 1 per side of the fireplace as shown in the image. If your fireplace needs the spacer, locate and remove the 2 screws shown below. Using the removed screws, align and install the spacers on each side.

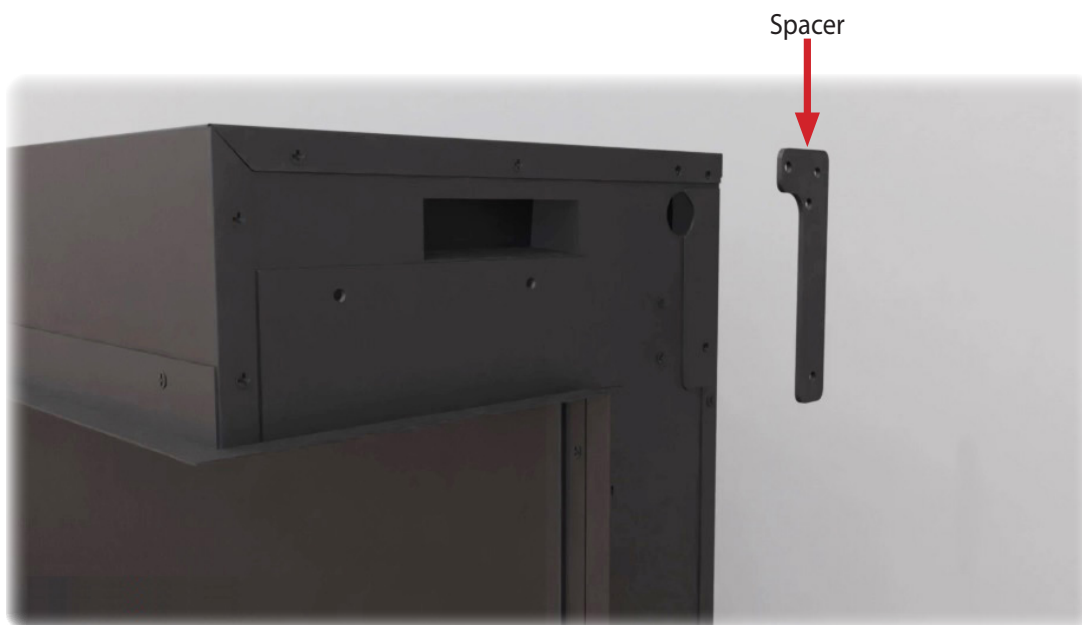

# Installation and Assembly

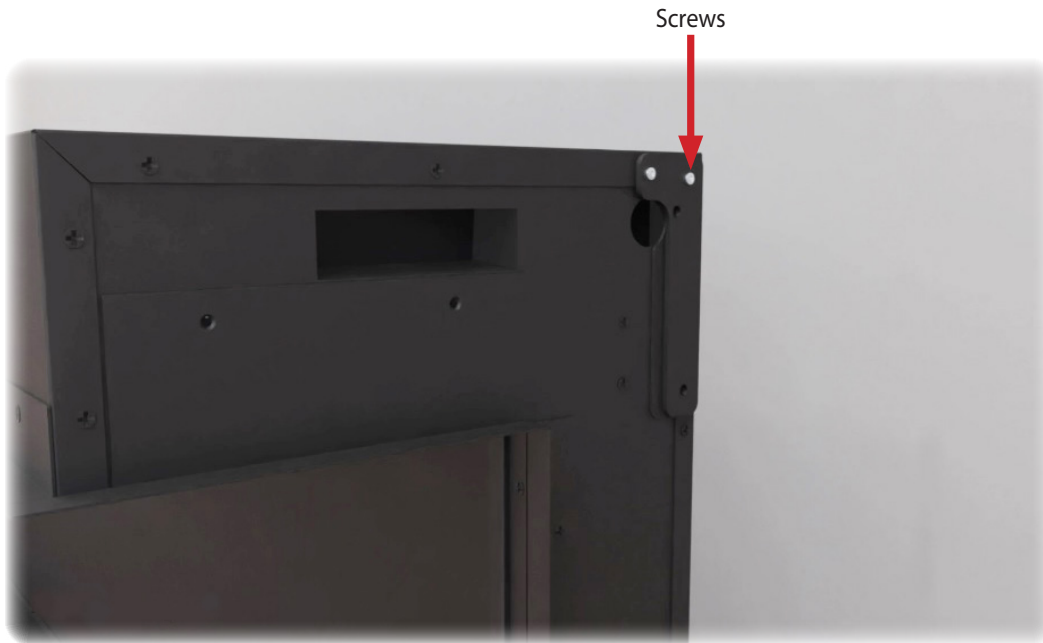

8

If using the power cord, attach the power cord to the fireplace going through the side access. Connect the power cord hot connection (black wire) to L1 on the fireplace terminal block, the power cord neutral connection (white wire) to N on the terminal block, and the ground wire (green wire) to the ground on the terminal block.

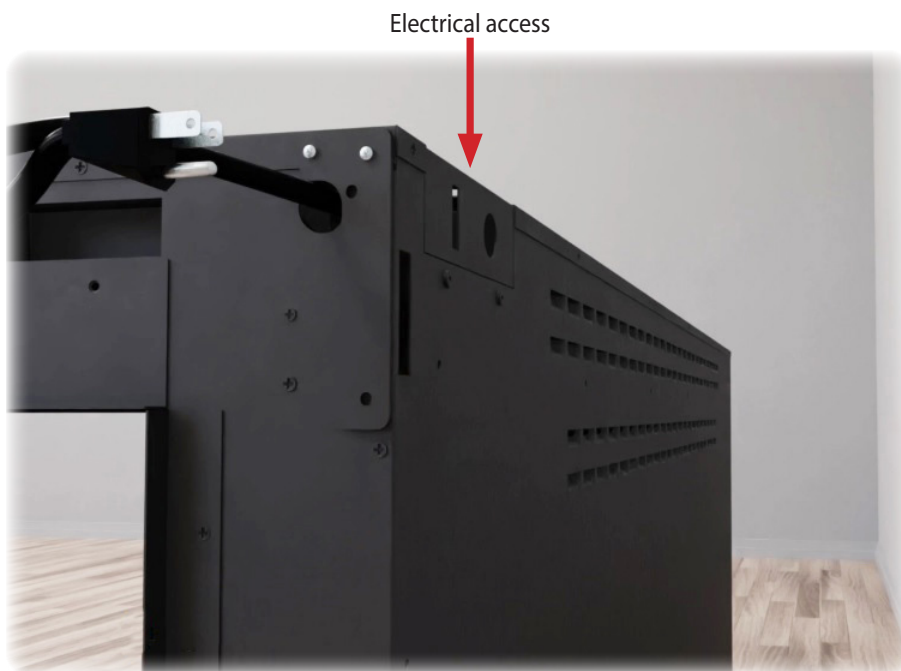



# Installation and Assembly

 **TURN OFF POWER FROM CIRCUIT BREAKER FIRST**

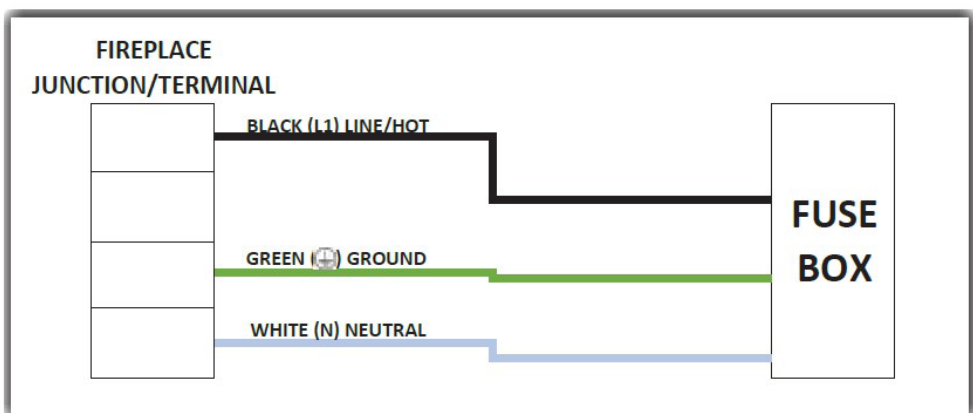
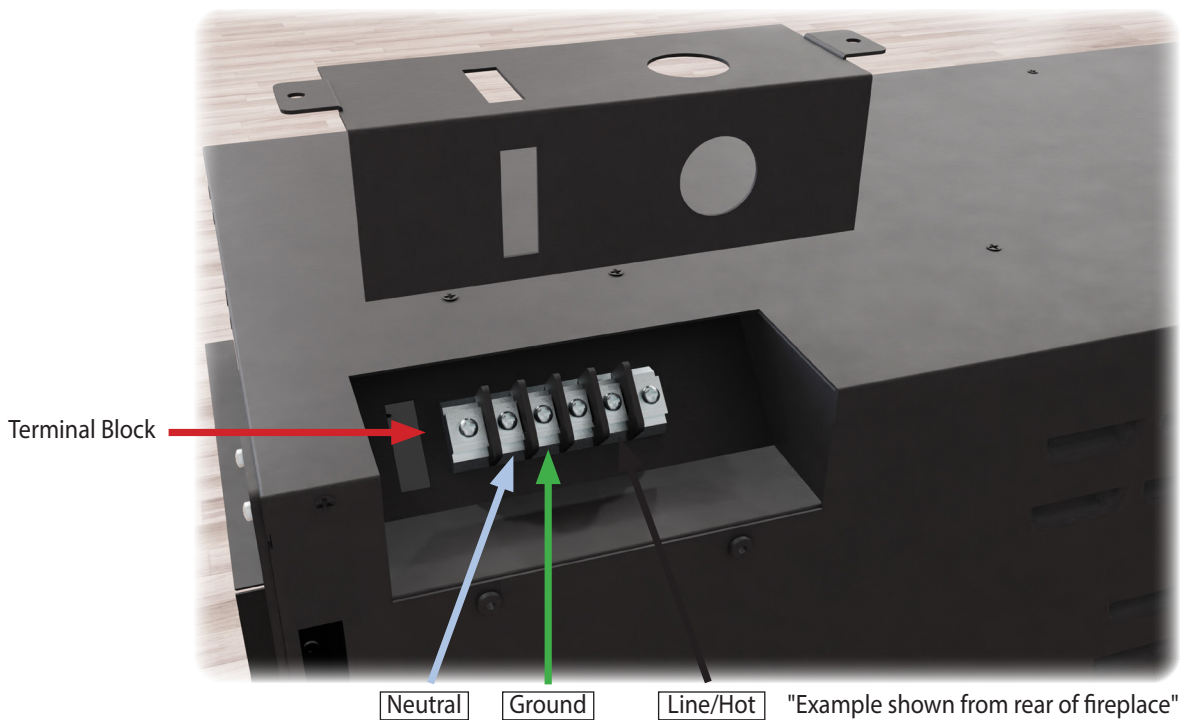

# Installation and Assembly



- 9 Lift the fireplace onto the wall mount bracket, ensuring both hooks on the bracket secure into the fireplace.



Slots in fireplace for bracket hooks.

# Installation and Assembly

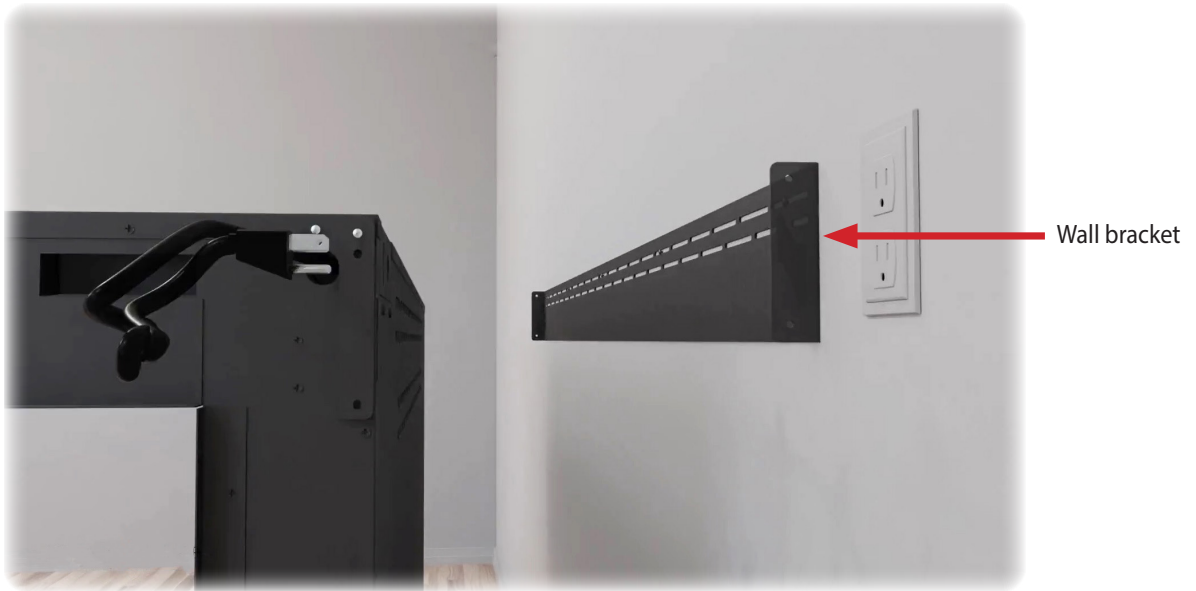

- 10 While pushing the fireplace towards the bracket and with the #8x3/4" self-drilling screws (x4), secure the fireplace to the bracket.

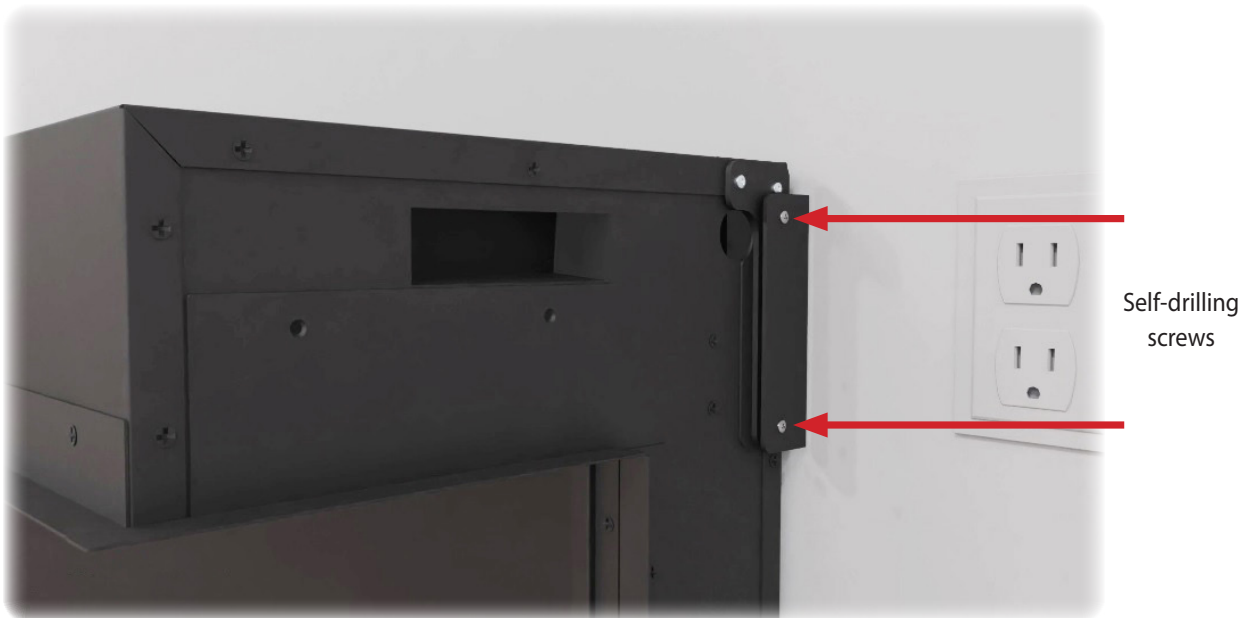

# Installation and Assembly

- 11 Power cord can now be connected to the outlet. Secure excess cable.

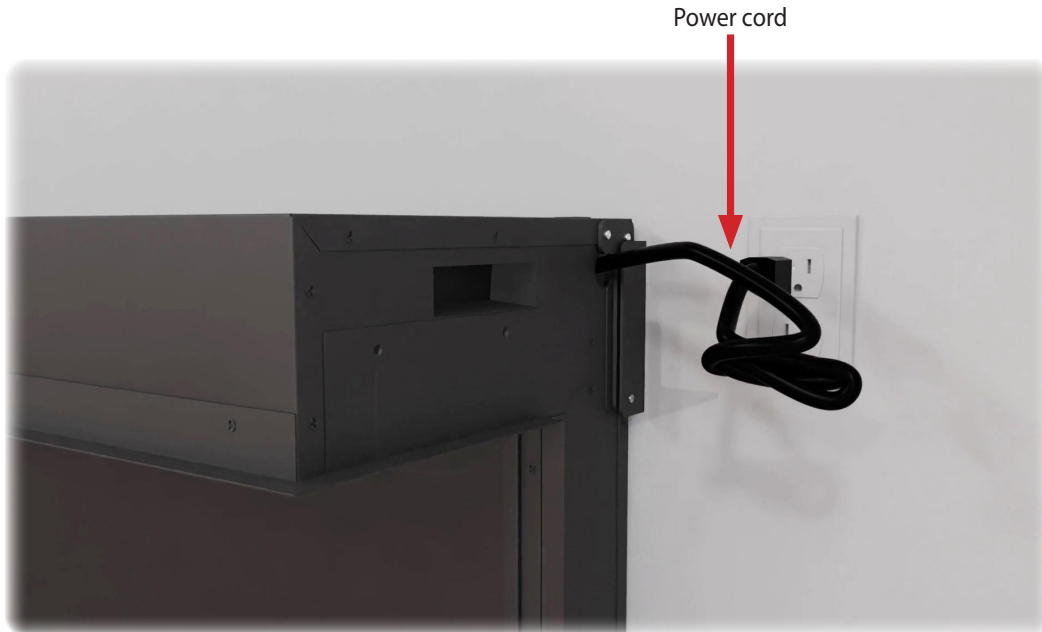

- 12 Install cabinet mount brackets to all four corners. See the below examples. On some versions of the LPM fireplace, a self-tapping screw for the front hole will be needed.

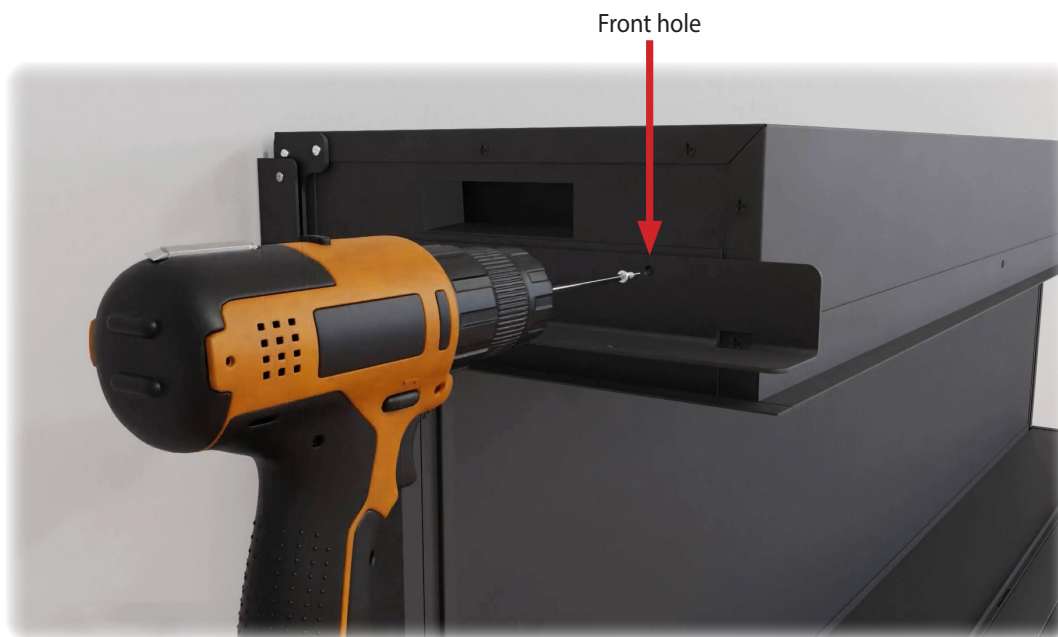

# Installation and Assembly

- 13** Binding may occur if there is not a 3/4" gap between bracket and drywall stop and if top or bottom suite is not inserted leveled and evenly on both sides.



- 14** Fireplace media and glass can now be installed. Reference the fireplace manual for details.

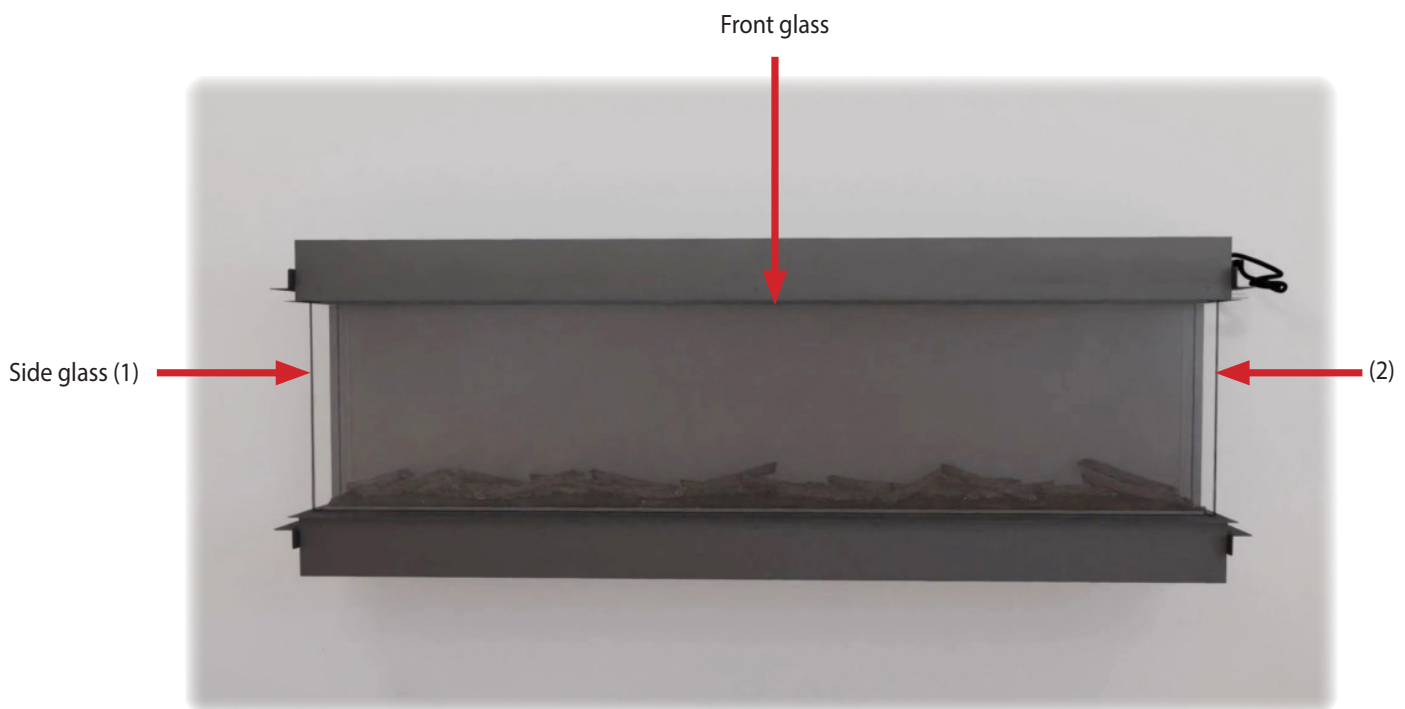

# Installation and Assembly

- 15 Evenly slide the bottom suite onto the fireplace by sliding it between cabinet mount brackets and drywall stops. If binding occurs ensure it is being inserted evenly and level.

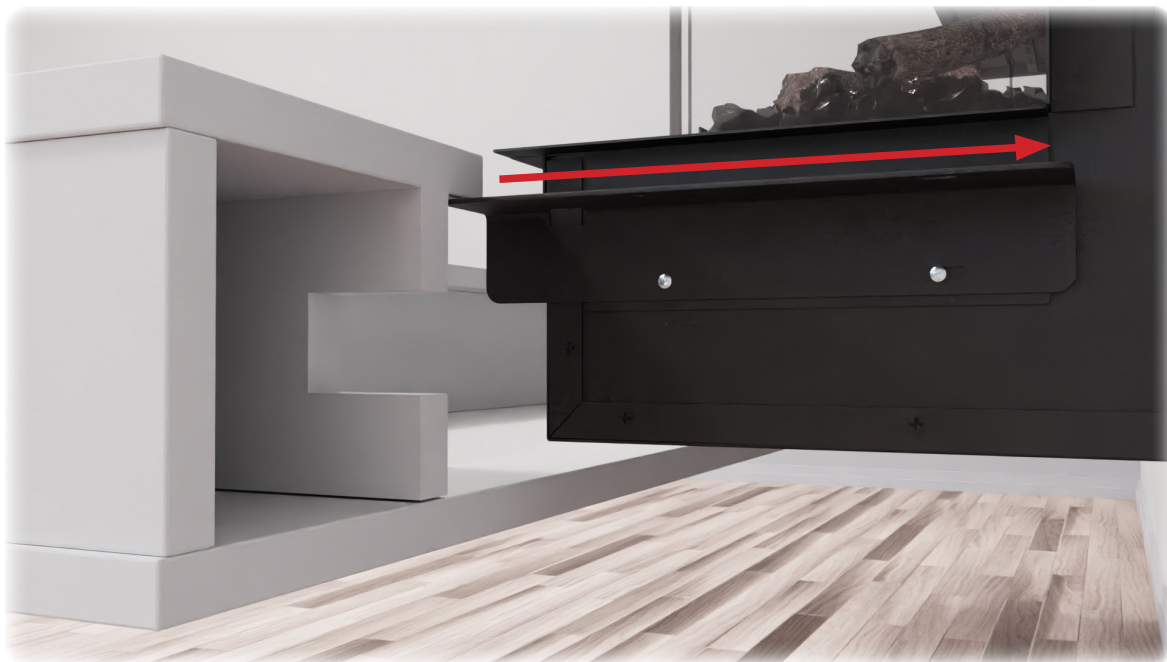

# Fireplace Installation



- 16** Evenly slide the top suite onto the fireplace by sliding it between cabinet mount brackets and drywall stops. Tuck any excess power cord wire in the cabinet cavity to ensure the top is fully inserted. If binding occurs ensure it is being inserted and leveled.



# Fireplace Installation





# Fireplace Installation

- 17 Starting at drywall stop, slide the side piece in, then push the remaining into place. Repeat the same step on the other side of the fireplace. Note these are friction fit, if there is not enough friction, a construction adhesive or double sided tape may be used to secure it to the fireplace.

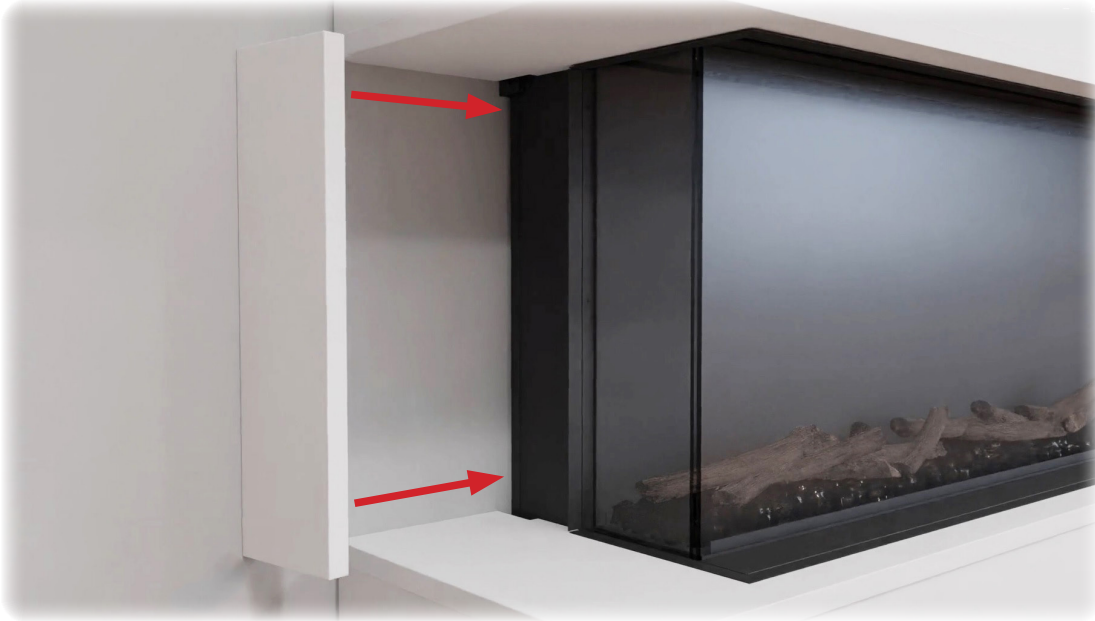

# Fireplace Installation

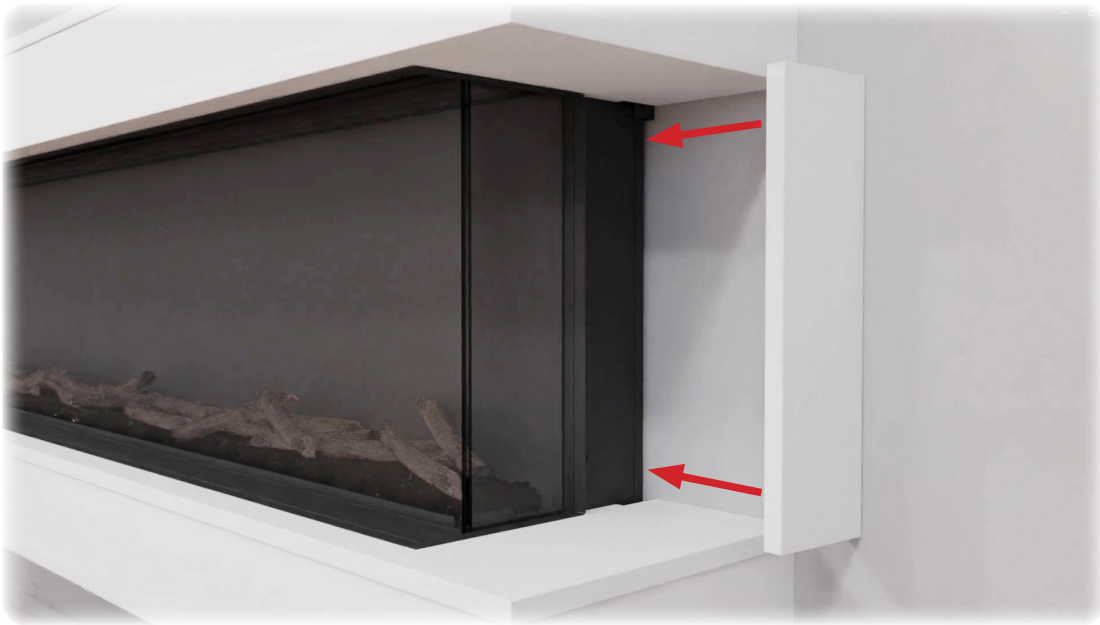

Note, the Studio studio suites for the LPM fireplace are simply slid in place for ease of installation. No additional screws or adhesive are required for the installation of the suite tops and bottoms. A silicone caulking can be used to finish where the suites meet the walls but it is not required.



# DO NOT RETURN TO STORE! CALL US FIRST

For immediate help with installation, product information  
or if your product arrives damaged,

please call our toll free number at:

1-877-246-9353

(Monday - Friday, 8:00AM - 5:00PM, AZ Mountain Time)

Or email us at:

[customerservice@modernflames.com](mailto:customerservice@modernflames.com)

OUR STAFF IS READY TO PROVIDE ASSISTANCE

# MODERN FLAMES

Thank you for choosing Modern Flames, we appreciate all our customers and hope you have many years of enjoyment of our products.

Take a look at our other products from our RPG Brands family of companies



[GrandCanyonGasLogs.com](http://GrandCanyonGasLogs.com)

For all your indoor, outdoor gas fireplaces & fire feature products.



[Wildfireoutdoorliving.com](http://Wildfireoutdoorliving.com)

For all your outdoor living products, such as grills, refrigerators and accessories.



Digital Copy

03012023

## RPG BRANDS

RPG BRANDS FAMILY OF COMPANIES

