



Cove 54" Linear Gas Fire Pit Table

with 12" x 42" Crystal Fire® Plus DSI Burner Kit

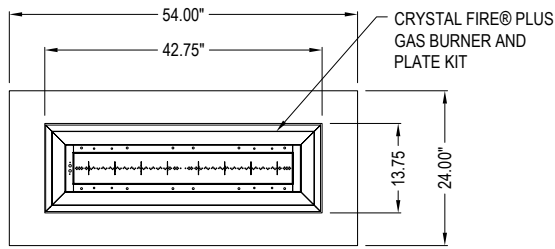
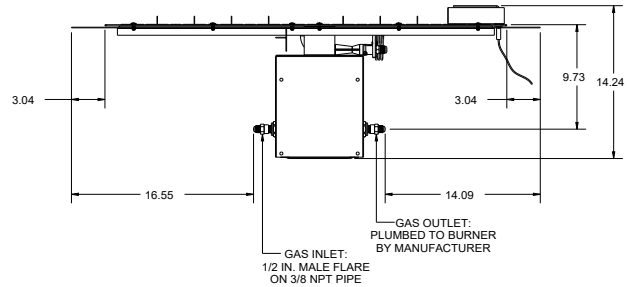

TABLE TOP VIEW



BURNER FRONT ELEVATION

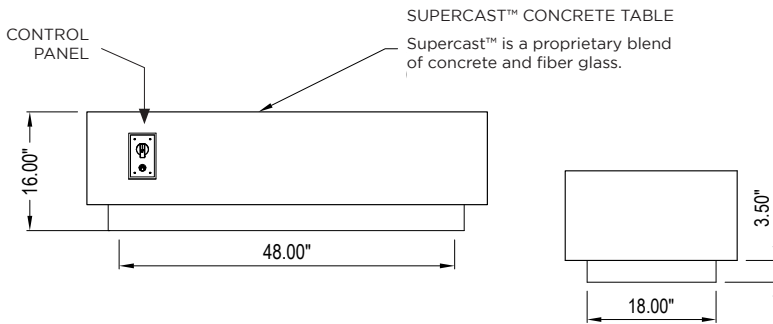
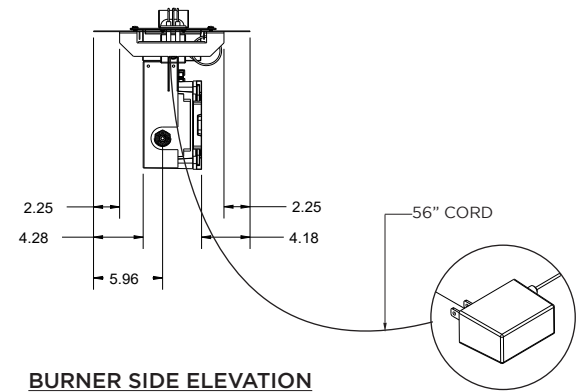

TABLE FRONT VIEW

TABLE SIDE VIEW



BURNER SIDE ELEVATION

Specifications:

PRODUCT NAME*	WEIGHT	BTUs (LP/NG)	FIRE MEDIA	BURNER KIT USED	KIT WEIGHT
CV-54, CV-54MM, CV-54WT + CF-DSI-NG or CF-DSI-LP (REQUIRED)	375 LBS	80K	20 LBS	BP1242DSILP-A/BP1242DSING-A	40 LBS

*COLOR OPTIONS: NATURAL GREY, MIDNIGHT MIST, OR WHITE.
*EACH BOWL INCLUDES CLEAR GLASS GEMS. OTHER FIRE MEDIA AND GLASS WIND GUARD (GLASS GUARD-1242) SOLD SEPARATELY.
TESTING AGENCY: UNDERWRITERS LABORATORIES (UL LLC)
STANDARD: ANSI Z21.97-02017 / CSA 2.41-2017 OUTDOOR DECORATIVE GAS APPLIANCES

Notes:

- CLEARANCE TO COMBUSTIBLES**
 - 72" from top of burner to any overhead combustible material. 24" from edge of burner trim to any combustible side walls. 4" from bottom of burner to combustible materials.
- GAS SUPPLY**
 - Natural gas - Operating Supply Pressure: Min 6" W.C.; Max 10.5" W.C.; Ideal 7" W.C.
 - Liquid Propane gas - Operating Supply Pressure: Min 8" W.C.; Max 14" W.C.; Ideal 11" W.C.
- ELECTRICAL**
 - RECOMMENDED: A readily accessible outlet on GFCI circuit should be installed within the enclosure to local electrical code. A weather proof cover (PT# CF-DSI-JB or equivalent) should be used. Must follow required local electrical code.
- CONTROLS**
 - Controls located on the Appliance Structure: Low voltage switch comes standard with DSI Burners. Optional 60-Minute Timer (PT# CF-DSI-60MT) or 4-Hour Timer (PT# 4HRTC) can replace low voltage switch.
 - Controls located away from the Appliance Structure: Outdoor-rated switches and timers (PT# CF-DSI-60MT) can be located on GFCI Circuit to control power to the junction box. Note: If operating burner with switch away from the appliance, the low voltage switch must be set to the ON position. Another option is to bypass the switch with PT# CF-DSI-SB.
 - Emergency Gas Shut Off: The E-Stop ships standard with the Direct Spark Ignition (DSI) burner and can be installed on the GFCI circuit to cut power to the appliance's junction box which will shut off flame.