

# MORE!

## Mountain Off-Road Enterprises Specialty Parts for Jeep Vehicles



Toll Free 877-JEEP-A2Z  
[www.mountainoffroad.com](http://www.mountainoffroad.com)



# Catalog Contents

**ARB Mounts and Accessories..... 29**  
**Axle Off-Set Plates..... 9**  
**Axle Mounting Hardware ..... 30**  
**Battery Tray..... 28**  
**Body Lift Kits/Systems..... 16-17**  
**Brake Lines ..... 11**  
**Bumpers/RockProof™ ..... 13-15**  
**Emergency Brake Cables ..... 26**  
**Frame Reinforcing Plates ..... 23**  
**Hide-a-Step ..... 29**  
**JK Skid Plates & Accessories ..... 28-30**  
**Lubeable Bolt/Bushing Kits..... 8**

**Motor Mounts/BombProof™ ..... 18-22**  
**Rod Ends/Tube Ends ..... 10**  
**Shackles/Lubeable ..... 8**  
**Shackle Reversal Systems..... 3-7**  
**Shock Mounts..... 27**  
**Spacers..... 10**  
**Spring Shackle Hangers..... 12**  
**Steering Components ..... 24-25**  
**Tie Rods, Drag Links, Trac Bars ..... 26**  
**Transmission Mounts ..... 11**  
**Universal Bushing Assemblies & Tabs..... 10-11**  
**Zerk Bolts & Protectors..... 9**



## Jeep® CJ Full Width Axle Kits

Our Full Width Axle Kit fits 1976-1986 Jeep® CJ's. This kit is designed to work with full width axles measuring 31-1/4" or 31-1/2" spring center to spring center. It also incorporates our S.R.S. design and will lift your Jeep 1" to 1-1/2" over stock height. Will work with any engine, stock or aftermarket bumpers and spring under or spring over applications. Cutting, grinding and welding required.

- 7686-FWK20.... 1976-1986 CJ's with 2.0" springs.
- 7686-FWK20NP.... 1976-1986 CJ's with 2.0" springs (Bare Steel)
- 7686-FWK25.... 1976-1986 CJ's with 2.5" springs.
- 7686-FWK25NP.... 1976-1986 CJ's with 2.5" springs (Bare Steel)

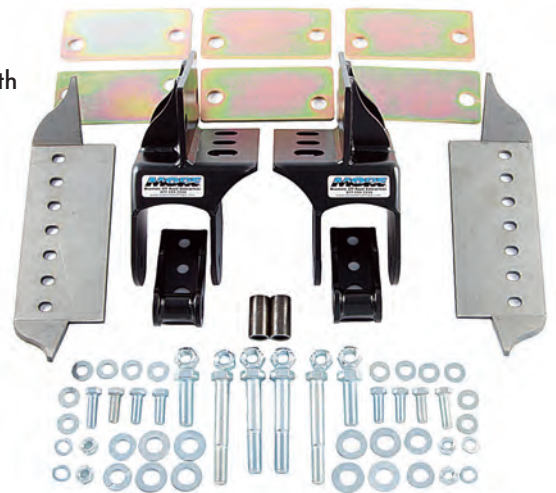

## YJ, TJ & JK Dead Pedal

M.O.R.E. has a new product for enhancing your comfort level while driving your Jeep YJ, TJ or JK. This new easy bolt-in Dead Pedal helps with leg fatigue that many of us get while driving when you do not have a place to support your foot. Powder Coated. Automatic only.

- DP0709DS (fits JK 07-current Driver Side)
- DP0709PS (fits JK 07-current Passenger Side)
- DP9706DS - Drivers Side (fits all TJ & YJ. Automatic only)
- DP9706PS - Passenger Side (fits all TJ & YJ. Automatic only)



DP9706PS  
Passenger Side

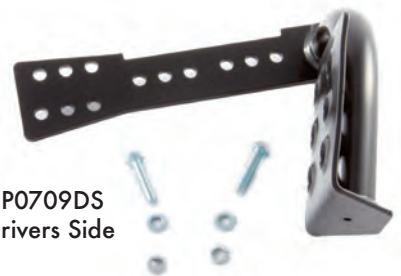

DP0709DS  
Drivers Side



# Jeep® Shackle Reversal Systems (S.R.S™)

Why install a S.R.S.™? Because it allows the front suspension to travel in a much more natural action when the spring compresses. In stock form (shackles in front of the front axle) when the front tire comes in contact with an obstruction, the impact is partially transmitted back to the frame via the solid rear pivot point. Reversing the pivot point to a point in front of the axle allows the impact to be better absorbed by the spring and shackle. The result is a more natural suspension flow over the obstacle. At higher speeds, a smoother ride and improved handling is noticeable, less wandering and darting are some other advantages.

All M.O.R.E.™ S.R.S.™ have a very important design feature built into the front pivot brackets. They move the front axle forward from the stock location. Why? When the shackle is reversed to behind the front axle, it will swing rearward and the tire will move slightly aft as the suspension compresses. Pushing the wheelbase forward will help keep the tire from contacting the fender during suspension compression. This is the only correct way to build a reversal system. Due to the action of this suspension movement, the front drive shaft needs to have more slip-yoke travel than stock (almost double!). With this in mind, the front drive shaft will have to have a longer travel slip-yoke installed by a professional drive line builder. Also, a stock pitman

arm may need to be retained (no drop) but will vary depending on the amount of lift you have on your Jeep®.

All bracketry is manufactured from .250" thick steel, Laser cut, holes laser cut or punched (not drilled), and precision bent to exact tolerances, all on CNC equipment, assembled in fixtures and pulse-welded for superior strength. No wimpy stuff here! Built to handle the abuses of gung-ho Jeepin'. All hardware is included with instructions and several pictures.

For the do-it-yourselfers, we offer our S.R.S.™ bare steel. None of the parts have been Powder Coated or zinc plated. This saves you money and allows you to customize your rig with any color you desire.

For the budget minded, we also offer them in Kit form. All of the pieces to build your own S.R.S.™ are included. If you are a welder/fabricator and can handle the assembly of the pivot brackets, weld them together by using your Jeep® frame as a jig. We've done all the cutting, punching of holes and slots, bending and most importantly, geometry for correct axle placement. All hardware is included (no powder coating or plating) along with detailed instructions for assembly.

The following pages detail the different S.R.S.™ that M.O.R.E.™ offers. Please read the information completely and you will find that your questions should be answered.



The above photo shows a 1994 YJ Wrangler with a 3.5" lift and stock shackles mounted in the factory stock location.



This photo is the same YJ with our S.R.S.™ installed with optional Lubeable Shackles (# LS9040). Notice how the axle is forward from the stock location.

## M.O.R.E. Product Review from 4X4 Review.com By Jody Campbell

After installation, we took the jeep out for a test drive. A medium-speed drive down a washed out road was no longer a thrill ride! I can now control the jeep on washboards and the front end feels planted on the road. Off-road and in the rocks the Jeep feels smoother and compresses the front end much easier. I also gained an additional 1.5 inches of suspension droop, but am told this is not always gained with every Jeep. The truly amazing result of this kit is the highway and city driving. The Jeep now feels totally different, no darting, jolting or wandering when I hit a bump. In my opinion, this kit is the single best handling improvement you will ever make to your Jeep, both on road and off!



## Shackle System

7686-10.....fits 1976-1986 Jeep® CJ-5, CJ-7, CJ-8 vehicles. This S.R.S. is in kit form. All of the pieces to build your own shackle reversal system are included. You simply weld the pivot brackets together yourself. Peg and hole construction for easy alignment, just square up and you weld the kit out and save.





# S.R.S.™ for Jeep® CJs

7686-1..... fits 1976-1986 Jeep® CJ-5, CJ-7, CJ-8 vehicles. Stock width springs (2") are required. The front pivot brackets are fully welded, powder coated, and ready to bolt into existing holes in your CJ frame. Spacers are provided for the purpose of different winch mounting possibilities, and/or if you want to use our frame plates (FP300). The shackles provided in this system are 3/8" thick steel, zinc plated gold. The mounting method for the shackles is unique with this system. You must drill a hole in each frame rail, then weld in 2" wide steel tubes. Polyurethane bushings insert into the tubes which support the shackle plates. The shackles hang from each side of the frame rails. This method of attachment keeps the drive shaft and caster angles as close to stock as possible, and gives ample clearance for off road obstacles. This system will work with stock springs and after market lift springs, however, it will not provide any lift in itself. It will work with springs under the axle (stock set-up) or if you have installed the springs over the axles (custom).

Stubby Frt. Brackets now Available. These brackets gain you 1 7/8" more clearance.

7686-2.....fits 1976-1986 Jeep® CJ-5, CJ-7, CJ-8 vehicles. This system has all of the features as the 7686-1, however it comes with wider (2.5") tubes to insert in the frame so you can install the wider Jeep® YJ Wrangler springs. Why you ask? The Wrangler springs typically have a softer spring rate than CJ's adding flexibility and ride quality. This system comes with the pivot brackets fully welded and powder coated, all hardware and instructions included. Wider U-bolt plates not included.

7686-2NP..... Same as above except no powder coating or plating. You save money.

7686-2SB\* .....Same as above except with the Stubby frt. brackets.

7686-2SBNP\* .....Same as above except with the stubby frt. brackets and no coating.

7686-20....fits 1976-1986 Jeep® CJ-5, CJ-7, CJ-8 vehicles. This SRS is in kit form. You weld the pivot brackets and install Wrangler springs under your CJ. None of the parts are coated. Wider U bolt plates not included.

Notes: The use of the Stubby Front Brackets may lower the front end 1.5" and increase the caster angle 3-4 degrees. This will depend on how the shackles are hung.

7686-1NP.....Same as above except no powder coating or plating.

7686-1SB\* .....Same as above except with the Stubby frt. brackets.

7686-1SBNP\* .....Same as above except with the Stubby frt. brackets and no paint.

7686-1

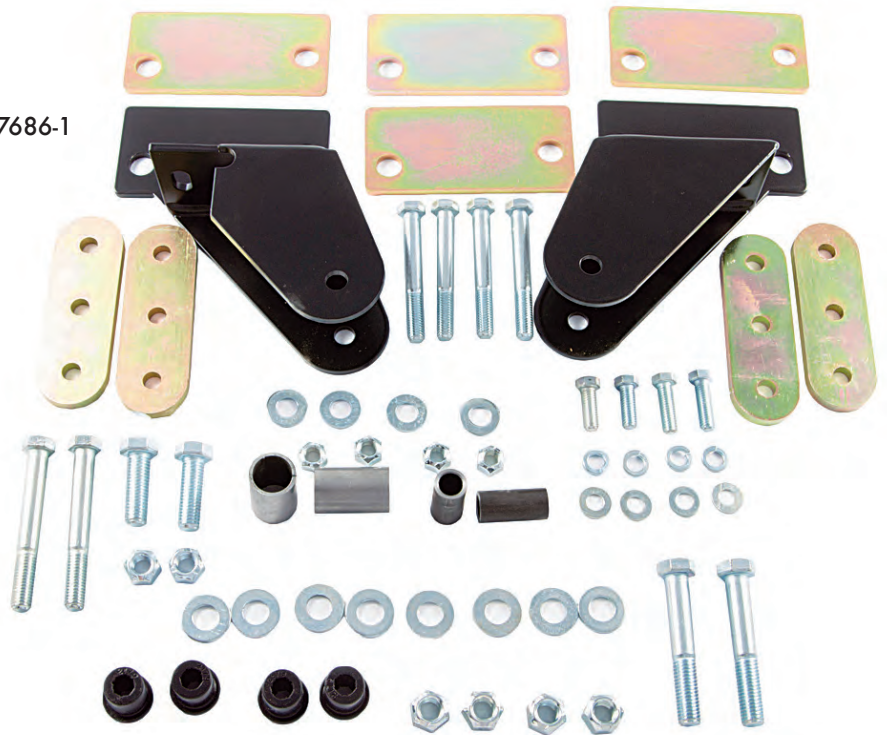

7686-2

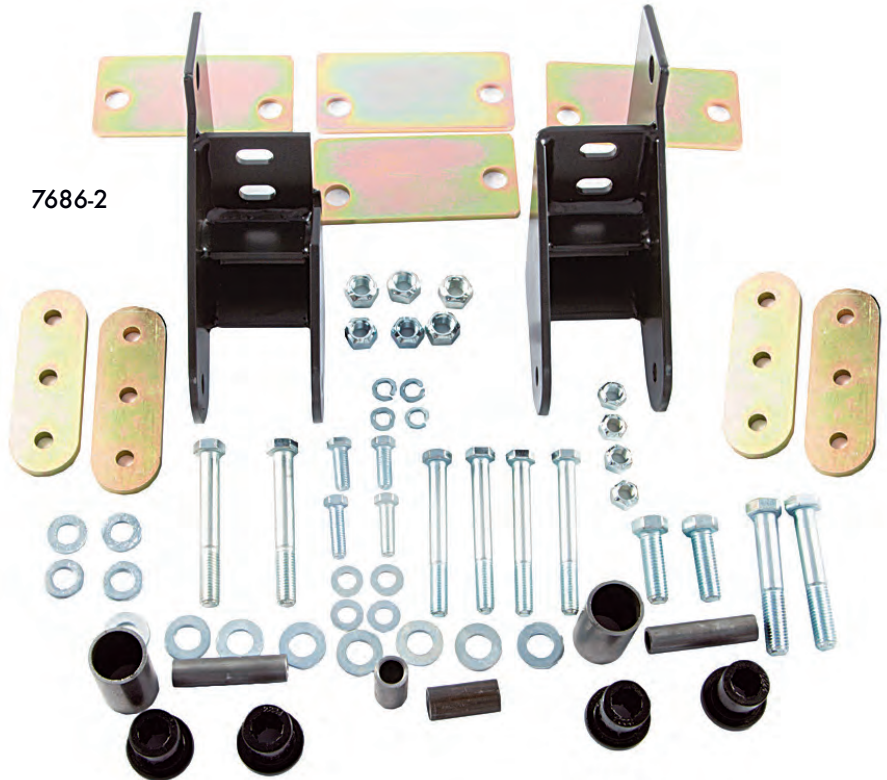

## Jeep® CJ Stubby Front Brackets

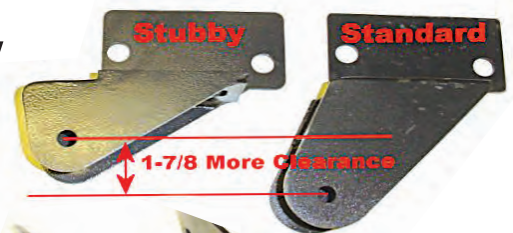

\*The use of the Stubby Front Brackets may lower the front end 1.5" & increase Caster angle 3-4°. This will depend on how the shackle is hung.





# S.R.S.<sup>™</sup> for Jeep<sup>®</sup> CJs

M.O.R.E. has come out with another way to attach your shackle to the frame on your CJ. This bracket is a complete bolt on and allows the use of either a stock 2" wide spring or the popular 2.5" YJ springs. Both the 7686-4 & 7686-6 kits will lift the Jeep 1.5" with the Standard front brackets.

7686-4..... fits 1976-1986 Jeep<sup>®</sup> CJ-5, CJ-7, CJ-8 vehicles. Stock width springs (2") are required. The front pivot brackets are fully welded, powder coated, and ready to bolt into existing holes in your CJ frame. Spacers are provided for the purpose of different winch mounting possibilities, and/or if you want to use our frame plates (FP300). The mounting method for the shackles is unique with this system. The Shackle Hanger is a complete Bolt-On bracket that is adjustable (fore & aft) on the frame. This is important for all the different leaf spring combinations. It will work with or without a lift kit, spring under or over the axles. This S.R.S.<sup>™</sup> will lift the front of your Jeep<sup>®</sup> one and a half inches. All brackets are fully assembled and powder coated, ready to bolt on. No welding required. Your shackles are retained.

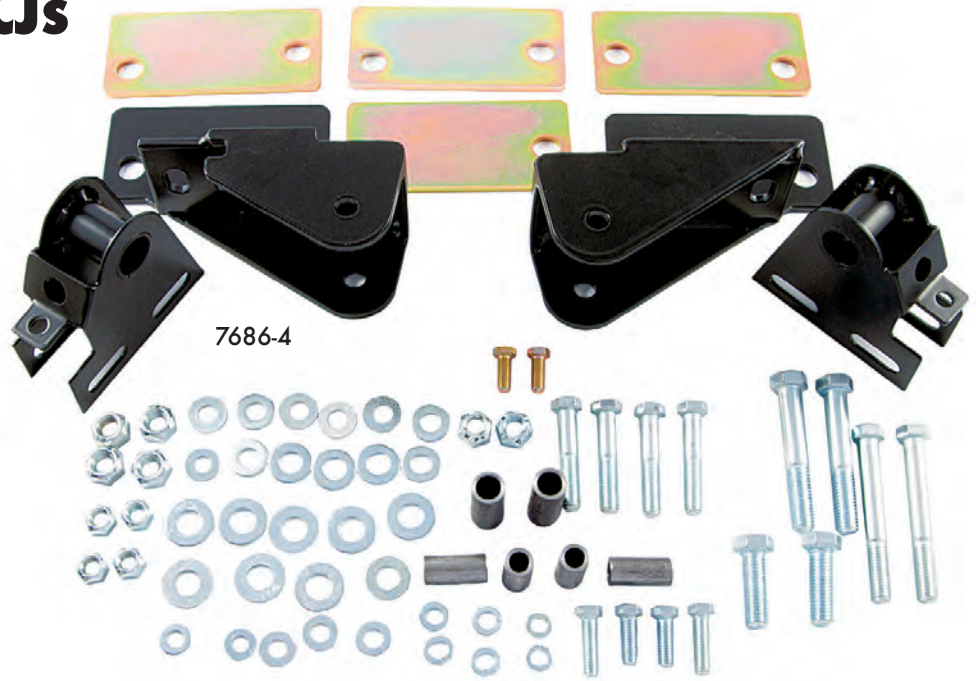

7686-4NP..... Same as above except no powder coating or plating.  
 7686-4SB\*..... Same as above except with the Stubby frt. Brackets.  
 7686-4SBNP\*..... Same as above except with the Stubby frt. Brackets and no powder coating or plating.

7686-6..... fits 1976-1986 Jeep<sup>®</sup> CJ-5, CJ-7, CJ-8 vehicles. For use with the 2.5" YJ springs. The front pivot brackets are fully welded, painted, and ready to bolt into existing holes in your CJ frame. Spacers are provided for the purpose of different winch mounting possibilities, and/or if you want to use our frame plates (FP300). The mounting method for the shackles is unique with this system. The Shackle Hanger is a complete Bolt-On bracket that is adjustable (fore & aft) on the frame. This is important for all the different leaf spring combinations. It will work with or without a lift kit, spring under or over the axles. This S.R.S.<sup>™</sup> will lift the front of your Jeep<sup>®</sup> one and a half inches. All brackets are fully assembled and powder coated, ready to bolt on. No welding required. Your shackles are retained.

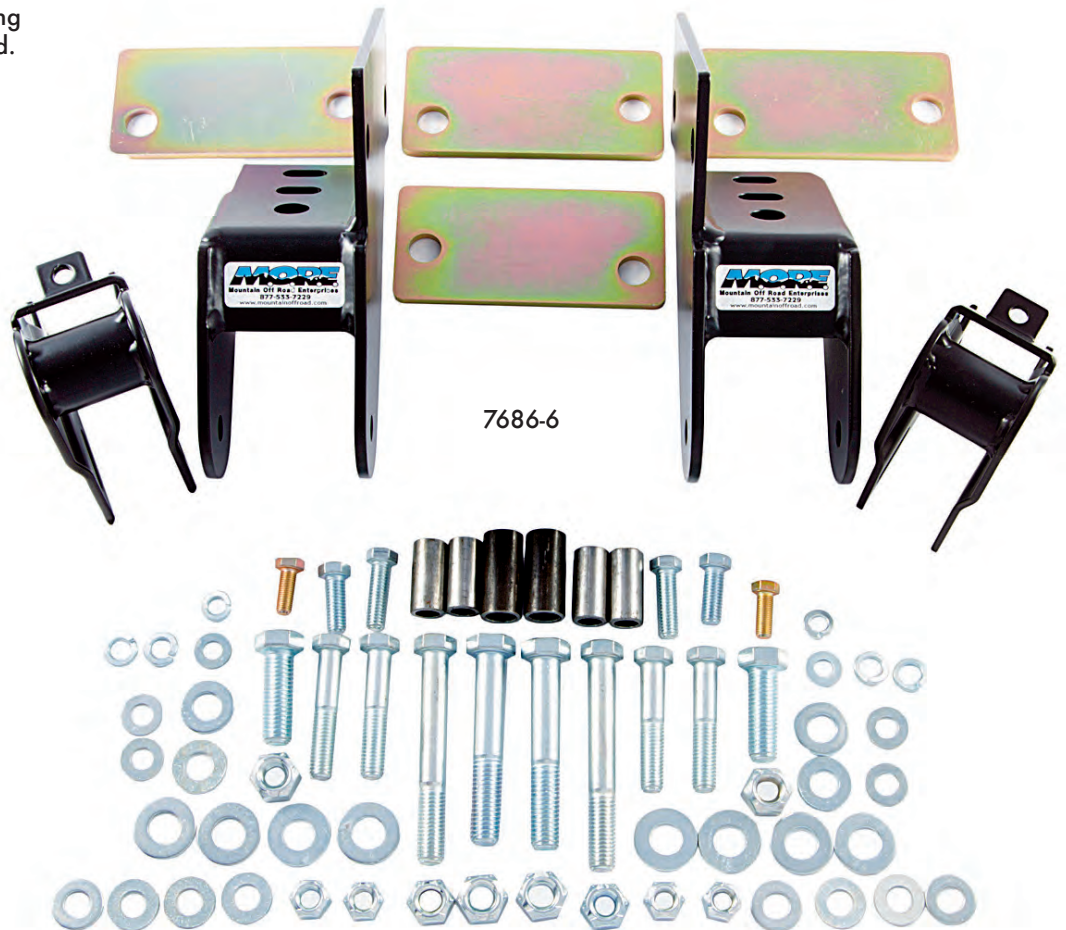

7686-6NP..... Same as above except no powder coating or plating.  
 7686-6SB\*..... Same as above except with the Stubby frt. Brackets.  
 7686-6SBNP\*..... Same as above except with the Stubby frt. Brackets and no powder coating or plating.



# S.R.S.™ for Jeep® CJs

Stock width springs (2") are required. The front pivot brackets are fully welded, painted and ready to bolt into existing holes in your CJ frame. Spacers are provided for the purpose of different winch mount possibilities and or if you want to use our frame plates (FP300) The mounting method for the shackles is unique with this system. The Shackle Hanger is a complete Bolt-ON bracket that is adjustable (fore & aft) on the frame. This is important for all different leaf spring combinations. It will work with or without a lift kit, spring under or over axles. This S.R.S. will lift the front of your Jeep 1-1/2". All brackets are fully assembled and powder coated, ready to bolt on. No welding required. Your shackles are retained.

7686-5.....fits 1976-1986 Jeep® CJ-5, CJ-7, CJ-8 vehicles. For the person who wants to buy just the front brackets and hardware and mount the shackles you own way. Brackets are fully welded and powder coated, instructions included.

7686-5NP.....Same as above except no powder coating or plating.

7686-5SB\* .....Same as above except with the Stubby front brackets.

7686-5SBNP\* .....Same As above except with the Stubby frt. brackets and no powder coating.

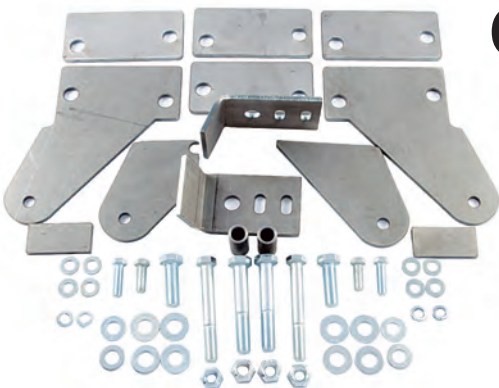

## CJ Stubby Front Brackets

\*The use of the Stubby Front Brackets may lower the front end 1.5" & increase Caster angle 3-4°. This will depend on how the shackle is hung.



7686-50.....fits 1976-1986 Jeep® CJ-5, CJ-7, CJ-8 vehicles. Front brackets and hardware in kit form.

You weld it and you save money. Peg and hole construction for easy alignment, just square up and you weld the kit out. No powder coating or plating.

# S.R.S.™ for Jeep® YJ Wrangler

8795-2.....1987-1995 Jeep® YJ Wrangler vehicles with ANY engine. The front pivot brackets are fully welded and powder coated. They bolt to the stock shackle mount and lower front bumper mounting holes and additional holes that you must drill in the frame. Your shackles mount to our unique shackle hanger that is adjustable (fore & aft) on the frame. This is important for all of the different leaf spring combinations available. It will work with or without a lift kit, spring under or over the axles. This S.R.S.TM will lift the front of your Jeep® one and a half inches. All brackets are fully assembled and powder coated, ready to bolt on. No welding required. Your shackles are retained. As with all of our Wrangler S.R.S.TM, we recommend using our SlipLoc™, or DoubleJointed™ tracbar.

8795-2NP.....Same as above except no powder coating

8795-2SB\* .....Same as above except with the Stubby front brackets.

8795-2SBNP\* .....Same as above except with the Stubby front brackets and no powder coating.

8795-20.....1987-1995 Jeep® YJ Wrangler vehicles with ANY engine. This S.R.S.TM is in kit form. All of the pieces to build your own S.R.S.TM are included. Use the frame of your Jeep® as a jig and weld the pivot brackets together yourself and save money. Your shackles mount to our unique shackle hanger that is adjustable (fore & aft) on the frame. This is important for all of the different leaf spring combinations available. It will work with or without a lift kit, spring under or over the axles. This S.R.S.TM will lift the front of your Jeep® one and a half inches. All hardware is included along with detailed instructions with lots of pictures. Peg and hole construction for easy alignment, just square up and you weld the kit out and save. Welding Required We recommend using our SlipLoc™, or DoubleJointed™ trac bar.

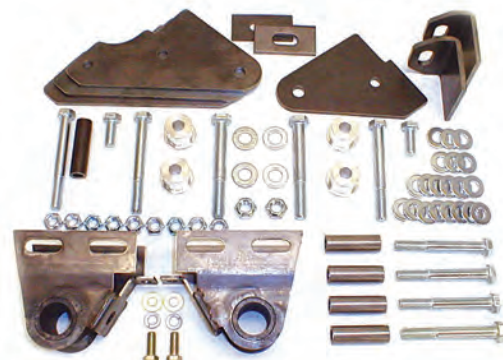



# S.R.S.™ for Jeep® YJ Wrangler



8798-3

8795-3.....1987-1995 Jeep® YJ Wrangler vehicles with ANY engine. The front pivot brackets are fully welded and powder coated. They bolt to the stock shackle mount and lower front bumper mounting holes and additional holes that you must drill in the frame. This S.R.S. mounts the shackle through the frame. You must drill a hole in the frame and weld a tube in it, then polyurethane bushings (provided) insert into the tube and the shackles (provided) hang from each side of the frame. This method will not lift the Jeep®.

8795-5.....1987-1995 Jeep® YJ Wrangler vehicles (all). For the person who wants to buy just the front brackets and hardware, then mount the shackles their own way. The pivot brackets are fully assembled and powder coated. No means of attaching your shackles are provided with this system.

8795-3NP.....Same as above except no powder coating.  
 8795-3SB\*.....Same as above except with the Stubby frt. brackets.  
 8795-3SBNP\*.....Same as above except with the Stubby frt. brackets and no powder coating.

8795-5SB\*.....Same as above except with the Stubby front brackets.  
 8795-5SBNP\*.....Same as above except with the stubby front brackets and no powder coating.

8795-50.....1987-1995 Jeep® YJ Wrangler vehicles (all). For the person who wants to buy just the front brackets and hardware, in "kit" form, weld the brackets together to save money. Peg and hole construction for easy alignment, just square up and you weld the kit out and save. No means of attaching your shackles are provided with this system.



8798-5

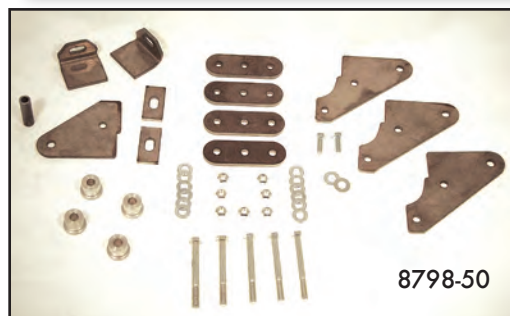

8798-50

## YJ Stubby Front Brackets

\*The use of the Stubby Front Brackets may lower the front end 1.5" & increase Caster angle 3-4°. This will depend on how the shackle is hung.

1 3/4" MORE clearance with Stubby

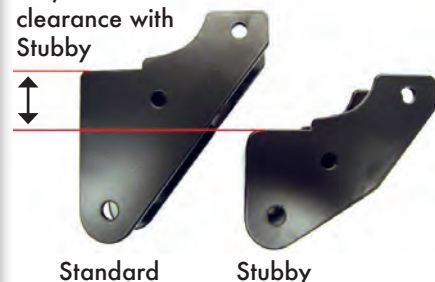

Standard

Stubby



# Shackles/Lubeable

M.O.R.E. Lubeable Shackles are laser cut out of 3/8" thick steel plate. We chose this method, over stamping them out of thinner steel. Super strong and Heavy Duty! A thick walled center brace bolts in place with grade 5 hardware. The bolts are "rifle" drilled and a grease zerk is installed. The black polyurethane bushings are channeled to allow the grease to flow throughout. Crimp lock nuts hold all parts in place. Zinc plated gold for corrosion resistance and good looks. Sold in pairs.

## Applications:

LS9033.....1946-1975 Jeep® CJ's (all). These shackles are 4-1/2" center to center. This will lift the vehicle 3/4" over stock. 3/8" Plate. Like LS9040.

LS9034.....1976-1986 Jeep® CJ-5, CJ-7, CJ-8 rear. These shackles are 4" center to center. This will lift the vehicle 1/2" over stock. 3/8" Plate. Like LS9040.

LS9035...1976-1986 Jeep® CJ-5, CJ-7, CJ-8 front. These shackles are 4" center to center. This will lift the vehicle 1/2" over stock. 3/8" Plate. Like LS9040.

LS9039....1987-1995 Jeep® YJ Wrangler rear\*. These shackles are 4" center to center. No lift. No center brace. 3/8" Plate. Like LS9040.

LS9039HD....1987-1995 Jeep® YJ Wrangler rear\*. These Heavy Duty shackles have larger 9/16" diameter holes. They are 4" center to center. No lift. No center brace. 3/8" thick plate. Like LS9040.

\*The above shackles come with bushings that measure 1-1/4" diameter.

\*\* The above shackles come with bushings that measure 1-1/2" diameter

LS9033



LS9039



LS9034



LS9035

# Lubeable Bolts/Bushing Kits

Have you got shackles that you're happy with, but want to make them Lubeable? Not a problem. We have Bolt-Bushing kits that provide you with grade 5 "rifle" drilled bolts with grease zerks installed, crimp-lock nuts, "channeled" black polyurethane bushings and drilled sleeves (where applicable). Makes any shackle "Lubeable". Available for the shackle end of the spring/frame and the main eye (pivot) end.

- KJ02018.....Shackle Bolt/Bushing Kit, 1946-1975 Jeep® CJ's (front or rear)
- KJ02019.....Shackle Bolt/Bushing Kit, 1976-1986 Jeep® CJ's (front)
- KJ02020\*.....Shackle Bolt/Bushing Kit, 1987-1995 Jeep® YJ's (front or rear)
- KJ02021.....Shackle Bolt/Bushing Kit, 1976-1986 Jeep® CJ's (rear)
- KJ02023.....Main Eye Bolt/Bushing Kit, 1987-1995 Jeep® YJ's (front and rear)
- KJ02024.....Main Eye Bolt/Bushing Kit, 1946-1975 Jeep® CJ's (front and rear)
- KJ02025.....Main Eye Bolt/Bushing Kit, 1976-1986 Jeep® CJ's (front and rear)



Note: To install Lubeable Bolt/Bushings in every point of your suspension, order two Shackle Kits and one Main Eye kit. All above Shackle Bolt/Bushing Kits are similar in appearance to photo

\*Please measure your spring eye diameter before ordering!



# Shackles/Lubeable

## Applications:

LS9040.....1987-1995 Jeep® YJ Wrangler front\*. These shackles are 4" center to center. No lift. 3/8" Plate.

LS9040HD.....1987-1995 Jeep® YJ Wrangler front\*. These Heavy Duty shackles have larger 9/16" diameter shackle bolts. These shackles are 4" center to center. No lift. 3/8" Plate.

LS9081.....1987-1995 Jeep® YJ Wrangler front or rear\*. These have "Boomerang" shaped side plates to allow it to clear the rear crossmember on full suspension compression, or in the front to act as a "Anti-Kick-Back" type shackle. They are 4-3/4" center to center and will lift the vehicle 3/8". 3/8" Plate.

LS9081HD.....1987-1995 Jeep® YJ Wrangler front or rear\*. These Heavy Duty shackles have larger 9/16" diameter shackle bolts. The "Boomerang shaped side plates allow it to clear the rear crossmember on full suspension compression, or in the front to act as a "Anti-Kick-Back" type shackle. They are 4-3/4" center to center and will lift the vehicle 3/8". 3/8" thick plate.

LS9091.....1987-1995 Jeep® YJ Wrangler front or rear\*\*. These have "Boomerang" shaped side plates and are designed to fit with the "Military" wrap springs. They are 5-1/4" center to center and will lift the vehicle 5/8". 3/8" Plate.

LS9091HD.....1987-1995 Jeep® YJ Wrangler front or rear\*\*. These have "Boomerang" side plates and use larger 9/16" diameter shackle bolts. These are designed to fit with the "Military" wrap springs. They are 5-1/4" center to center and will lift the vehicle 5/8".

\*The above shackles come with bushings that measure 1-1/4" diameter.

\*\* The above shackles come with bushings that measure 1-1/2" diameter



## Shackle Side Plates

- 9050Z...4-1/2" C to C Straight Plate, Zinc Plated, Sold Ea.
- 9040...4" C to C Straight Plate, Bare Steel, Sold Ea.
- 9040Z...4" C to C Straight Plate, Zinc Plated, Sold Ea.
- 9081Z...4-3/4" C to C Boomerang Plate, Zinc Plated, Sold Ea.
- 9091Z...5-1/4" C to C Boomerang Plate, Zinc Plated, Sold Ea.

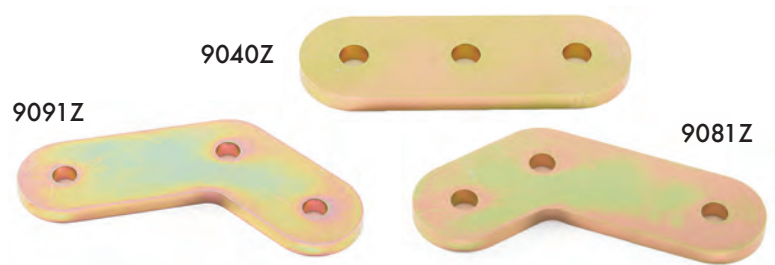

## Zerked Bolts

Do you want just the Zerked Bolts for that Do- It-Yourself project?

- S10191.....Zerked bolt ,1/2"-13 x 4 "
- S10193.....Zerked bolt ,1/2"-13 x 4 1/2"
- S10199.....Zerked bolt ,9/16"-12 x 4 1/2"



## Zerked Protectors

Tired of breaking your grease zerk's off ? We have the Answer. Counter sunk in order to protect your zerk heads.

- ZP12.....Zerk protector 1/2" bolt.
- ZP916.....Zerk protector 9/16" bolt.



## Axle Off-Set Plates

Now you can move the axle on the leaf springs with out major modifications. Use these Axle Off-Set Plates to re-locate the housing ether 3/4" or 1" forward or back depending on which hole you choose. The only other part that needs to be re-drilled is the U-bolt plate. Made from 1/4" thick steel. Zinc plated for rust prevention.

- OP20.....Pair, 2" wide leaf springs.
- OP25.....Pair, 2-1/2" wide leaf springs





# Universal Mounting Tabs

Several different shape tabs are available for mounting different accessories such as shocks, lights, link bars, exhaust systems, Universal Bushing Assemblies, or what ever you like. Most are 3/16" thick, hole is pre punched, and are ready to weld on.



**PART # T-125.....Universal clevis mount.**  
This clevis mounting tab is 1/2" thick steel, with a 1" diameter hole. It has two "tangs" on the weld end so you can pierce holes in the bumper and weld it on both sides.

**PART # EF38 - Exhaust Flange,**  
3/8" thick. For 2.5" exhaust.

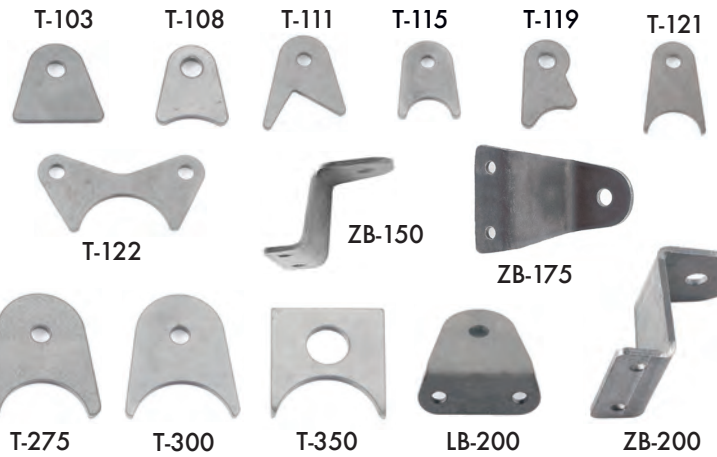

# Rod Ends/Tube Ends/Tubing

Want to build your own tie rods, trac bars, radius arms or link bars or what-ever, and need the Rod Ends to perform the task? We stock the most popular sizes in right and left threads. These are race-car quality, 52100 bearing steel ball, Teflon®/Kevlar® self-lubricating race, and have a alloy steel heat-treated body. They come with a jam nut. Tube Ends welded to steel tubing (also available from M.O.R.E.TM) to give you threaded ends for your custom project, without a lathe. Many other sizes are available on a special order basis, please call.



## Rod Ends

PART #	SHANK THREAD	BALL DIA.
XMR10	5/8" Right	5/8"
XML10	5/8" Left	5/8"
XMR12	3/4" Right	3/4"
XML12	3/4" Left	3/4"
XMR10-12 3/4-16	3/4" Right	3/4"
XML10-12 3/4-16	3/4" Left	3/4"



## Tube Ends

PART #	THREAD
TE10R*	5/8"-18 Right
TE10L*	5/8"-18 Left
TE11R**	11/16"-18 Right
TE11L**	11/16"-18 Left
TE12R**	3/4"-16 Right
TE12L**	3/4"-16 Left
TE14R***	3/4"-16 Right Tube End
TE14L***	3/4"-16 Left Tube End



## High Deflection Washer & Spacers

PART #	
TS58230	5/8" Rod End Spacer
HDW58	5/8 High Misalignment Washer
HDW34	3/4 High Misalignment Washer



## Jam Nuts

PART #	THREAD
JN58R	5/8-18 Right
JN58L	5/8-18 Left
JN1116R	11/16-18 Right
JN1116L	11/16-18 Left
JN34R	3/4-16 Right
JN34L	3/4-16 Left

\* 1-1/8"X.188 wall D.O.M. Tubing  
\*\* 1-1/4"X.188 wall D.O.M. Tubing  
\*\*\* 1-1/2"X.250 wall D.O.M. Tubing





# Transmission Mounts/Polyurethane

Replace the stock rubber transmission and torque arm mounts with these black polyurethane units. They are not affected by oil or grease, road grime or salt. They will tighten-up the way your Jeep® feels and help hold the drive train in place.

KJ01008.....Transmission Mount, each. 1966-86 Jeep® CJ (all), 1987-95 YJ's (all), 1974-91 J-10, J-20, Wagoneer, Cherokee ( Full Size ).

KJ01001.....Torque Arm Mounts, pair. 1966-86 Jeep® CJ (all), 1987-95 YJ's (all), 1974-91 J-10, J-20, Wagoneer, Cherokee.



# DOT Stainless Braided Brake Lines

PART #	DESCRIPTION	APPLICATION
SBL23F*	23" Long Frt Line	ALL Jeep CJ,YJ,TJ,XJ
SBL25F*	25" Long Frt. Line	ALL Jeep CJ,YJ,TJ,XJ
SBL28F*	28" Long Frt. Line	ALL Jeep CJ,YJ,TJ,XJ
SBL20R	20" Long Rear Line	ALL Jeep CJ,YJ,TJ,XJ
SBL24R	24" Long Rear Line	ALL Jeep CJ,YJ,TJ,XJ

\*Include Mounting Brackets and compression washers .



# Universal Bushing Assemblies

Universal Bushings Assemblies are handy items for the person who likes to fabricate their own parts. For varied applications such as motor mounts (same as we use in our BombProof™ mounts), cage to frame mounting points, spare tire carriers, cargo racks, link bars, trac bars, radius arms or where ever you need a component to be held tight, rattle free, absorb vibration yet still be removable. All U.B.A. come with two polyurethane bushing halves (black), outer steel tubing, inner steel sleeve, mounting bolt and locking nut.

PART #	TUBING SIZE OD	LENGTH	BOLT
BA200	2" X .120	3"	9/16"
BA175	1-3/4" X .120	3"	9/16"
BA150	1-1/2" X .120	2-1/4"	7/16"
BA125	1-1/4" X .095	2"	3/8"
BA100*	1" X .095	1-1/2"	3/8"

\*No inner steel sleeve on BA100



# Polyurethane Bushings

Replace those old squeaky worn out bushings with M.O.R.E.'s new polyurethane bushings.

- 2042.....1-1/2" x 3/4" x 1-1/2" long Polyurethane
- 2153.....1-1/2" x 3/4" x 1-1/2" long Polyurethane
- 2203.....1" x 1/2" x 1-1/4" long Polyurethane
- 2221.....1-1/4" x 3/4" x 1-1/2" long Polyurethane
- 2047.....1" x 1/2" x 1-1/2" long Polyurethane
- 2431..... 1-3/4" x 3/4" x 1-1/2" long Polyurethane



# Clevite Mount Bushings

Replace your JM600 motor mount bushings with these Clevite bushings. These are stock replacement bushings for the Jeep® TJ and XJ control arms.

Part # 52001161



# Steering Box Skid Plate

Protect your steering box with our skid plate. Made out of 7 gauge steel and bolts on for full steering box protection.

SBS97.....1997-2006 Jeep® TJ's, all.





# Spring Shackle Hangers

These heavy duty spring hangers are great direct replacement units for serious rock crawling and abuse. 3/16" and 1/4" Steel (except SR104, SR105, SR106), well reinforced and designed for stock springs, after-market lift springs, spring under axle, spring over axle or for those of you who want to convert

7686FSH2.0CJ.....1976-1986 Jeep® CJs, front pair. For 2" wide CJ width springs. 1" diameter bushings.

7686RSH2.5CJ.....1976-1986 Jeep® CJs, rear pair. For 2-1/2" wide CJ width springs, 1" diameter bushings.

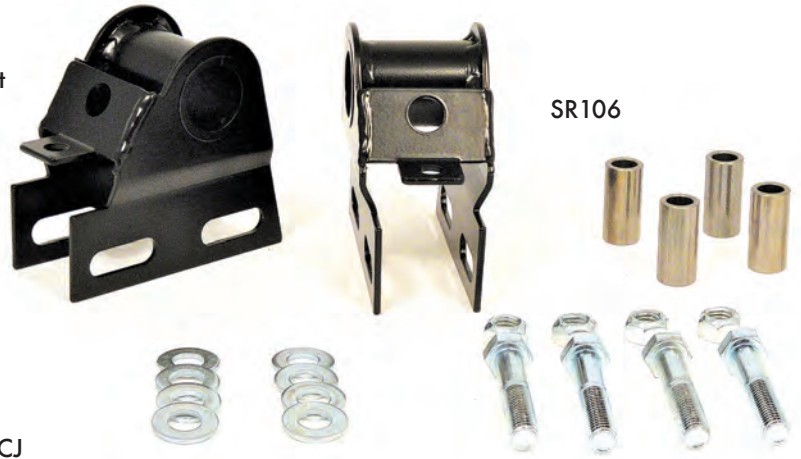

7686FSH2.0CJ

SR103.....1987-1995 Jeep® YJ's front heavy duty shackle hanger replacement. Sold in pairs. Welding required.

SR104.....1987-1995 Jeep® YJs front pair. For shackle reversal, bolt on, adjustable fore & aft for shackle angle.

SR105.....1976-1986 Jeep® CJs front pair. For 2" wide springs with shackle reversal, bolt on, adjustable fore & aft for shackle angle

SR106.....1976-1986 Jeep® CJs front pair. For 2.5" wide springs with shackle reversal, bolt on, adjustable fore & aft for shackle angle

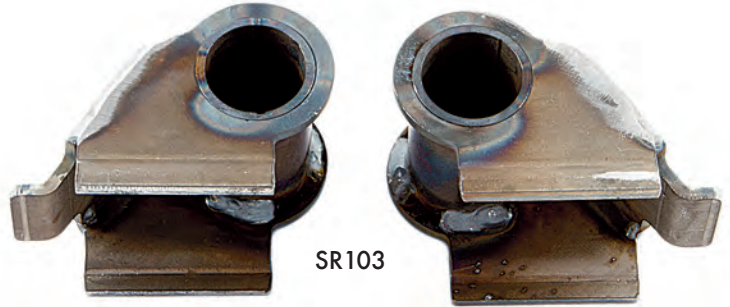

SR103



SR105



SR104



7686FSH2.5YJ



7686RSH2.5YJ

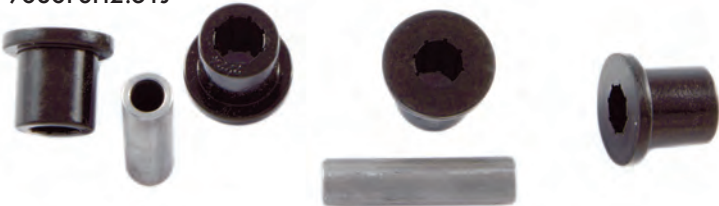

7686FSH2.5YJ.....1976-1986 CJ-5, CJ-7, CJ-8 front pair. For 2-1/2" wide YJ width springs. 1-1/4" diameter bushings.

7686RSH2.5YJ.....1976-1986 CJ-5, CJ-7, CJ-8 rear pair. For 2-1/2" wide YJ width springs. 1-1/4" diameter bushings.



# Hi-Clearance RockProof™ Bumpers

Designed for the serious Jeep® who needs the extra clearance, yet protection. We have taken our popular RockProof™ Bumper and given it "Wings". Yep, it will let your Jeep® fly over the rocks, yet still protect the fenders. This new design gives your Jeep® several more inches of clearance and approach angle. There is plenty of flat area for those of you who want to add your own lights or grill/fender protection. Super strong, yet only weighs 62 pounds, and that includes the winch mount! It allows a winch to mount as low as possible in it's pocket, and the winch fairlead can bolt on the front face of the bumper.

JFBHC100.....1976-1986 Jeep® CJ's, all. Available Bare Steel or Powder coated  
JFBHC200.....1987-1995 Jeep® YJ's, all. Available Bare Steel or Powder coated  
JFBHC300.....1997-2006 Jeep® TJ's, all. Available Bare Steel or Powder coated



# RockProof™ Flat Bumpers

Are you looking for a front bumper for your Jeep® that protects the fenders, holds a winch and looks great? The RockProof™ Bumper will do the trick. This is not your average bumper, folks. It takes some serious equipment to make a genuine RockProof™ Bumper! Most aftermarket bumper manufactures simply make their bumpers from box steel tubing or thin metal, enclose the ends, weld on some mounting tabs and call it good. This ultra clean looking RockProof™ Bumper is laser cut out of 3/16" steel then formed on a CNC Brake. The seams are MIG welded, ground and sanded for a clean appearance, Yes true American craftsmanship. Two eyelets are welded (front and back) for a clevis, or tow bar attachment, and there is plenty of flat area for those of you who want to add your own lights or grill/fender protection. It is shipped bare steel or powder coated. These bumpers ship UPS which saves on truck freight! Super strong, yet only weighs 62 pounds! It allows a winch to mount as low as possible

JFB100.....1976-1986 Jeep® CJ's, all. Available Bare Steel or Powder coated  
JFB200.....1987-1995 Jeep® YJ's, all. Available Bare Steel or Powder coated  
JFB300.....1997-2006 Jeep® TJ's, all. Available Bare Steel or Powder coated





# RockProof™ JK Bumpers

JEEP JK RockProof™ BUMPERS M.O.R.E.™ Protection for you JK. The newest line up of our popular RockProof™ bumpers. Both bumpers are made from laser cut 7 gauge steel and formed using a CNC Brake. The front bumper incorporates a winch mount, clevis mounts and reuses the OEM fog lights. The rear incorporates wrap around corners to protect your Jeep from rock rash and also has a flush underneath 2" receiver hitch with safety chain hooks. To handle the big tires, up to 40", you can get the tire swinger with your rear bumper that includes a Hi-Lift Jack mount. The new JRB 800 swinger opens with your rear door and includes a safety latch feature which will secure the door in the open position so you will never have a rear swinger hit you while you are on un-level ground.

- JFB500..... 2007-current JK, Stubby Front Bumper
- JFB501..... 2007-current JK, Stubby Front Bumper w/ Tube Work
- JFB504..... 2007-current JK, Full Width Bumper for Factory Fenders - No Tube Work
- JFB505..... 2007-current JK, Full Width Bumper for Factory Fenders w/ Tube Work

JFB500



JFB501

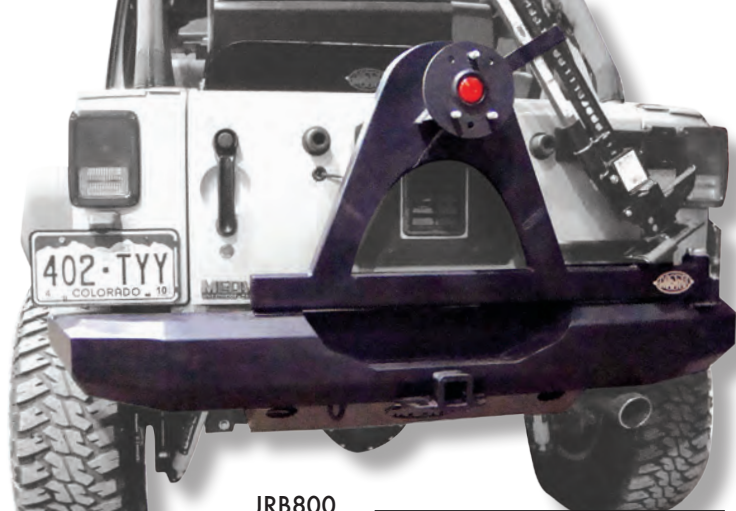
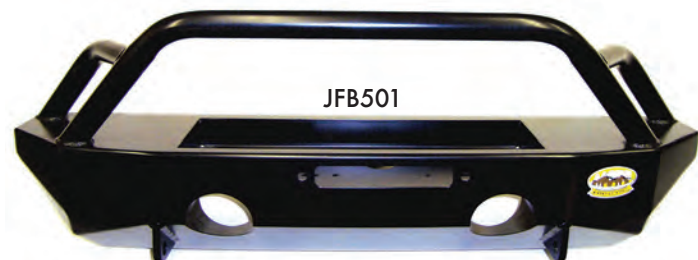

JRB800



- JRB800..... 2007 Jeep® JK, Rear Bumper w/ Tire Carrier
- JRB801..... 2007 Jeep® JK, Rear Bumper Only

JFB505



JFB505





# "Stubby" RockProof™ Bumpers

Are you looking for a front bumper for your Jeep® that gives you maximum clearance, holds a winch and looks great? The Stubby RockProof™ Bumper will do the trick. Two eyelets are welded (front and back) for a clevis, or tow bar attachment, and there is plenty of flat area for those of you who want to add your own lights or grill/fender protection. Available powder coated textured black or bare steel so you can paint it to match your Jeep®. These bumpers ship UPS which saves on truck freight! Super strong, yet only weighs 52 pounds! It allows a winch to mount as low as possible in it's pocket so the winch fairlead can bolt on the front face of the bumper.

JFBS100.....1976-1986 Jeep® CJ's, all. Available Bare or Powder Coated  
 JFBS200.....1987-1995 Jeep® YJ's, all. Available Bare or Powder Coated  
 JFBS300.....1997-2006 Jeep® TJ's, all. Available Bare or Powder Coated

Fits CJ, YJ and TJ rigs.



# "XJ" RockProof™ Bumpers

Designed for the serious Jeeper who needs to protect their XJ out on the trail. We have taken our popular RockProof™ Bumper design and molded it to protect the front of your XJ while giving it a super strong mount for your winch. This new design gives your Jeep® more clearance and approach angle. Two eyelets are welded (front and back) for a clevis, or tow bar attachment, There is plenty of flat area for those of you who want to add your own lights or grill/fender protection. Super strong, yet only weighs 79 pounds, and that includes the winch mount! It allows a winch to mount as low as possible in it's pocket, and the winch fairlead can bolt on the front face of the bumper.

JFB400.....1984-2001 Jeep® XJ's all. Available Bare or Powder Coated



# RockProof™ Rear Bumpers

M.O.R.E.™ Has the answer for the rear of your Jeep. This new rear bumper and or rear bumper with tire carrier is made from laser cut 7 gauge steel and formed using a CNC Brake. These bumpers wrap around the corner of your Jeep to protect from rock rash, incorporate a 2" receiver hitch, Hi-Lift jack mount and will handle tires up to 40". Also the tire carrier has safety latch feature which will secure it in the open positions. Now Available for 1987-2006 Jeep Wranglers and 1976-1986 Jeep CJ's.

- JRB900TJ.....1997-2006 Jeep® TJ's, all. (With Tire Carrier)
- JRB900YJ.....1987-1995 Jeep® YJ's, all. (With Tire Carrier)
- JRB700CJ.....1976-1986 Jeep® CJ's, all. (With Tire Carrier)
- JRB901TJ.....1997-2006 Jeep® TJ's, all. ( Bumper Only)
- JRB901YJ.....1987-1995 Jeep® YJ's, all. (Bumper Only)
- JRB701CJ.....1976-1986 Jeep® CJ's, all. (Bumper Only)
- JRB600XJ.....1984-2001 Jeep XJ's,
- JRB601XJ.....1984-2001 Jeep XJ's (Bumper Only)



JRB-900TJ



JRB-600XJ



# One Inch Body Lift Kits/ Body Lift Systems

Have you got BIG tires that just barely rub the fenders of your Jeep®? Lift the body away just a little (one inch) with these solid "Pucks". Made from aircraft quality 6061 T-6 aluminum, they will not crush, break or move around once bolted in place. No plastic parts to look cheap or break under load. Natural aluminum color looks great under your rig, or you can paint or anodize them, if you desire. Dimensions: 2" in diameter, 1" tall, and have a 1/2" hole size. Available individually, as a Body Lift Kit, or as a Body Lift System.

The Body Lift Kits consist of enough "Pucks" for your Jeep®, longer grade 5 bolts, flat washers, miscellaneous brackets and instructions.

The Body Lift Systems come with everything the Kits come with, in addition to Polyurethane Body Mounts. Save time and money and install a "System" under your Jeep®.



BLTJ97

BP225X1 .....	Individual Puck 1" Fits .....	Universal Body Lift Puck
BLTJ97S .....	Body Lift System 1" .....	1997-2006 Jeep® TJ Wrangler (5-speed, auto & A/C)
BLYJ8795 .....	Body Lift Kit 1" .....	1987-1995 Jeep® YJ Wrangler (5-speed)
BLYJ8795A .....	Body Lift Kit 1" .....	1987-1995 Jeep® YJ Wrangler (auto trans.)
BLTJ97 .....	Body Lift Kit 1" .....	1997-2006 Jeep® TJ Wrangler & Unlimited (All Trans. & A/C)

# Steering Pillow Block

This kit will raise the steering pillow block to get rid of the annoying bump feel that occurs with the 1" & 1-1/4" body lifts. Available for 4.0L (6 cylinder) or 2.5L (4 cylinder)

BLTJ97SBK.....4.0 L 6 cylinder  
BLTJ97SBK-4.....2.5 L 4 cylinder



BLCJ7679



BLCJ7679 .....	Body Lift Kit 1" .....	1976-1979 Jeep® CJ-5, CJ-7
BLCJ7679S .....	Body Lift System 1" .....	1976-1979 Jeep® CJ-5, CJ-7



# One Inch Body Lift Kits/Body Lift Systems

BLC8086



BLY8795AS



BLCJ8086	..... Body Lift Kit 1"	..... 1980-1986 Jeep® CJ-5, CJ-7
BLCJ8086S	..... Body Lift System 1"	..... 1980-1986 Jeep® CJ-5, CJ-7
BLYJ8795S	..... Body Lift System 1"	..... 1987-1995 Jeep® YJ Wrangler (5-speed)
BLYJ8795AS	..... Body Lift System 1"	..... 1987-1995 Jeep® YJ Wrangler (auto trans.)
BLJK2D	..... Body Lift Kit 1"	..... 2007-2010 Jeep® JK Wrangler 2 Door (All Trans. & A/C)
BLJK4D	..... Body Lift Kit 1"	..... 2007-2010 Jeep® JK Wrangler 4 Door (All Trans. & A/C)
BLCJ8185	..... Body Lift Kit 1"	..... 1981-1985 Jeep® CJ-8(Scrambler)

BLJK4D



BLCJ8185





# Body Mounts/Polyurethane

Replace the old worn out rubber body mounts that are on your Jeep® with new Polyurethane. These specially formulated Polyurethane bushings are soft enough to allow flex yet tough enough to withstand heavy duty abuse. They will not "squeak" or make noise. The factory tube/sleeves must be re-used for CJ applications. Black only.

- KJO4001 ..... Body Mounts, Black Polyurethane 1955-1973 Jeep® CJ-5
- KJO4002 ..... Body Mounts, Black Polyurethane 1980-1986 Jeep® CJ-5, 7
- KJO4003 ..... Body Mounts, Black Polyurethane 1976-1979 Jeep® CJ-5, 7
- KJO4005 ..... Body Mounts, Black Polyurethane 1987-1995 Jeep® YJ
- KJO4006 ..... Body Mounts, Black Polyurethane 1974-1975 Jeep® CJ-5
- KJO4008 ..... Body Mounts, Black Polyurethane 1997-2006 Jeep® TJ



# Sports Cage/ Frame Tie In

WCK101.....1976-1986 Jeep® CJ's, 1987-1995 YJ's. (The front cage foot plate must be installed over the drain hole in the floor).

## 9706LCABK

TJ,XJ Replacement lower control arm brackets. 3/16" material fully welded with cam adjuster horse-shoe. Welding required.

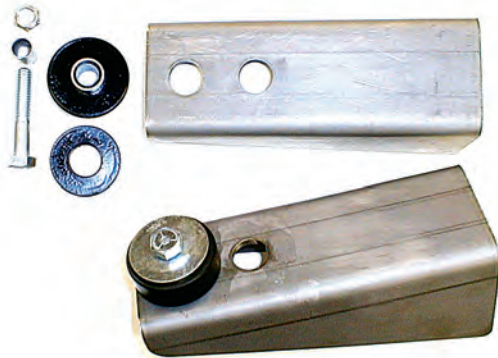

## 3.0 SPGHGR

Universal 3" wide spring hanger for most 2.5" wide springs. 1/4" material fully welded, Can be bolted or welded.

# Universal Motor Mounts/BombProof™

CB100.....Universal. This is the Block Mount that bolts up to Chevrolet small or big block, and V-6 engines. This is for the person who wants to fabricate their own motor mounts into a vehicle that we do not build complete BombProof™ Mounts for. Save time and money with these pre-fabricated block plates that utilize our BA200 Bushing Assembly. Bare steel, no paint. The same block mount that is used with our JM400 and JM200 Motor Mounts.

JM360.....Universal. This is the Block Mount that bolts up to any AMC V-8. For the person who wants to fabricate their own motor mounts into a vehicle that we do not build complete BombProof™ Mounts for. Save time with these pre-fabricated block plates that utilize our BA200 Bushing Assembly. Bare steel, no paint. The same block mount that is used with our JM301 Motor Mounts.



JM360



CB100



CB700

CB700.....Universal. This is the Block Mount that bolts up to Chevrolet Generation III or IV Engine Block. This is for the person who wants to fabricate their own motor mounts into a vehicle that we do not build complete BombProof™ Mounts for. Save time and money with these pre-fabricated block plates that utilize our BA200 Bushing Assembly. Bare steel, no paint. The same block mount that is used with our JM700 motor mounts.



# Motor Mounts/BombProof™ Polyurethane

Now that rock crawling has become the favorite past time for Jeepers, and we are putting our Jeeps in places that they were never designed to go, the stresses on the stock motor mounts are tremendous. With deep gearing, big tires, lockers, and mega torque, the stock mounts can be torn apart in no time at all. That is where these BombProof™ Motor Mounts come into play. These are the ultimate motor mounts that you can install in your Jeep® vehicle. They will create a cross member with the engine, improve clutch linkage operation and beef up your Jeep® for serious wheelin'. They bolt into stock holes in the frame and engine, and in most applications, no modifications are needed. Black polyurethane bushings insulate from steel to steel contact. All BombProof™ Motor Mounts are bare steel or zinc plated gold.

## Jeep® CJ BombProof™ Motor Mounts



JM100

JM100.....1972-1986 Jeep® CJ's, all, equipped with AMC 6-cylinder engines (4.0L or 4.2L). These mounts will fit with stock exhaust manifolds or aftermarket headers. The stock block plates must be re-used. Bare steel, no paint.

JM100Z.....Same as above, except zinc plated gold.



JM200.....1972-1986 Jeep® CJs, all, converting to Chevy V-8 engines (small or big block). These mounts are pre-punched for existing holes in the frame, however some applications require welding. They will offset the engine slightly to the drivers side for front driveshaft clearance. You must use a transfer case with a passenger side front drive shaft (Dana 18, Dana 20, Dana 300. Quadratrac®, etc.)  
Bare steel, no zinc plating available.



JM200



JM301Z

JM301.....1972-1986 Jeep® CJs, all, equipped with AMC V-8 engines. These mounts locate the engine in the factory stock location. They allow the use of stock exhaust manifolds, or aftermarket headers (in-frame or fender well). Bare steel, no paint.

JM301Z.....Same as above, except zinc plated gold.

JM500.....1972-1986 Jeep® CJs. all, converting to a Ford small block V-8 (289, 302, 351). These mounts bolt to existing holes in the frame and engine and will place it in the proper location for you. They will offset the engine slightly to the drivers side to keep the crankshaft centerline correct with the rear differential, so a transfer case with a passenger side front drive shaft must be used. Bare steel, no zinc plating available.

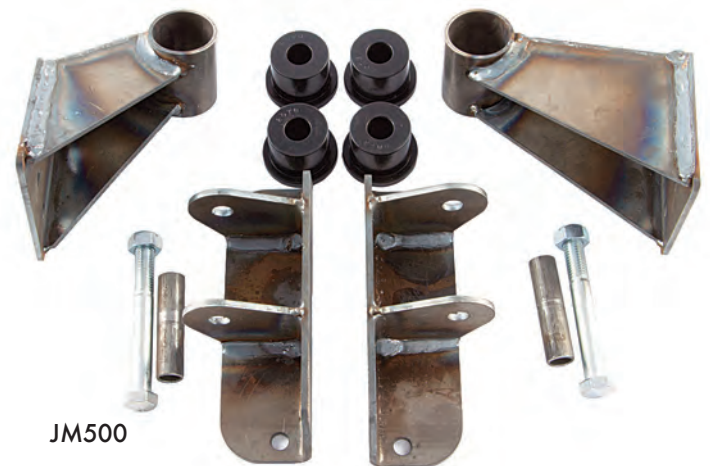

JM500



# Jeep® YJ Wrangler BombProof™ Motor Mounts

JM25840.....1987-1995 Jeep® YJ Wranglers, with factory installed 6-CYLINDER engines\* (4.0L or 4.2L). Bare Steel, no paint.

JM25840Z.....Same as above except zinc plated gold.

\*In some applications the factory block mount may require minor grinding to install.



JM25840L.....1987-1995 Jeep® YJ Wranglers, with factory in- stalled 6-CYLINDER engines\* (4.0L & 4.2L), AND a one inch body lift! These mounts will lift the engine so no modifications to the fan shroud are necessary. It can help correct rear drive line angle as well. Bare Steel, no paint.

Note: These may require modifications to the factory frame mounts.

JM25840LZ.....Same as above except zinc plated gold.

# Torsion Rubber Style BombProof™ Motor Mounts

M.O.R.E. has a new style BombProof™ Motor Mount available. Instead of using Polyurethane for insulating the chassis from engine vibration, we use Torsion rubber. These fine mounts keep the engine clamped in place far better then the stock motor mounts, yet do not transfer vibration like the urethane bushings. Noticeable Vibrations W/ 2.5L Engines. All 600 series motor mounts are zinc plated gold.

JM600.....1987-1995 Jeep® YJ Wrangler vehicles equipped with 6-CYLINDER engines (4.0L or 4.2L). These new style mounts utilize a Torsion rubber bushing that absorbs vibration better then polyurethane.

JM600L.....Same as above, one inch lifted version.



JM601 \* .....1987-1990 YJ Wranglers equipped with 4-CYLINDER (2.5L) engines.

JM601L \* .....1987-1990 Y Wrangler equipped with 4-CYLINDER (2.5L) engines AND a one inch body lift.

JM602 \* .....1991-1995 YJ Wranglers equipped with 4-CYLINDER (2.5L) engines.

JM602L \* .....1991-1995 YJ Wranglers equipped with 4-CYLINDER (2.5L) engines AND a one inch body lift.

\* Noticeable Engine Vibrations with these mounts on 4 cylinder engines



JM400....1987-1995 Jeep® YJ Wrangler Converting to Chevy V- 8 (small or big block) engines. The factory motor mounts must be removed from the frame to install these mounts. These mounts are indexed to existing holes in the frame so line-up is a breeze. These mounts must be welded to the frame. They are designed to offset the engine to the passenger side slightly, to keep the crankshaft centerline correct with the rear differential, so a transfer case with a drivers side front drive shaft must be installed (231 or 241). Bare steel, no zinc plating available



# Jeep® TJ/LJ Wrangler BombProof™ Motor Mounts

JM25840.....1997-2006 Jeep® TJ/LJ Wranglers, with factory installed 6-CYLINDER engines (4.0L). Bare Steel, no paint.

JM25840Z.....Same as above except zinc plated gold.



JM25840L.....1997-2006 Jeep® TJ/LJ Wranglers, with factory installed 6-CYLINDER engines (4.0L), AND a one inch body lift! These mounts will lift the engine so no modifications to the fan shroud are necessary. It can help correct rear drive line angle as well. Bare Steel, no paint.

JM25840LZ.....Same as above except zinc plated gold.

# Torsion Rubber Style BombProof™ Motor Mounts

M.O.R.E. has a new style BombProof™ Motor Mount available. Instead of using Polyurethane for insulating the chassis from engine vibration, we use Torsion rubber. These fine mounts keep the engine clamped in place far better than the stock motor mounts, yet do not transfer vibration like the urethane bushings. Noticeable Vibrations W/ 2.5L Engines. All 600 series motor mounts are zinc plated gold.

JM600.....1997-2006 Jeep® TJ/LJ Wrangler vehicles equipped with 6-CYLINDER engines (4.0L). Pictured.

JM600L.....Same as above, one inch lifted version.

JM603\* .....1997-2002 TJ Wranglers equipped with 4-CYLINDER (2.5L) engines.

JM603L\* .....1997-2002 TJ Wrangler equipped with 4-CYLINDER (2.5L) engines AND a one inch body lift.

\* Noticeable Engine Vibrations with these mounts on 4 cylinder engines.

JM603

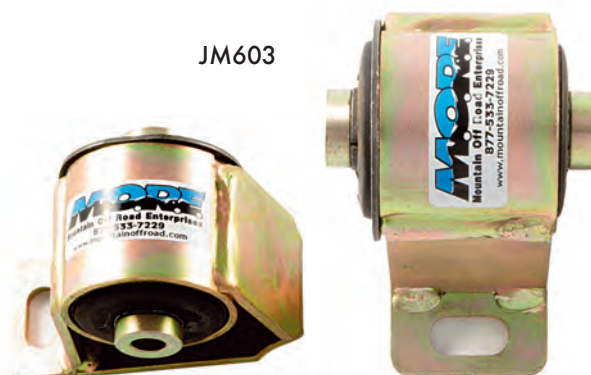

JM603L



JM700

JM700.....M.O.R.E. continues to keep ahead of the competition with these JM700 motor mounts. We have spent countless hours test fitting the JM700 mounts, on several chassis with several engine/transmission combos and the JM700 fits them all with slight or no modifications. This motor mount is designed to fit Jeep Wrangler TJ 1997-2006 Jeep when installing a Generation III Chevy V-8 or Generation IV Chevy V-8. The JM700 mounts are designed to off-set the engine slightly to the passengers side of the Jeep frame for front drive shaft clearance at the transmission. This means that you must use a transfer case with a drivers side front drive shaft.





# Motor Mounts/BombProof™ Polyurethane

Now that rock crawling has become the favorite past time for Jeepers, and we are putting our Jeeps in places that they were never designed to go, the stresses on the stock motor mounts are tremendous. With deep gearing, big tires, lockers, and mega torque, the stock mounts can be torn apart in no time at all. That is where these BombProof™ Motor Mounts come into play. These are the ultimate motor mounts that you can install in your Jeep® vehicle. They will create a cross member with the engine, improve clutch linkage operation and beef up your Jeep® for serious wheelin'. They bolt into stock holes in the frame and engine, and in most applications, no modifications are needed. Black polyurethane bushings insulate from steel to steel contact. All BombProof™ Motor Mounts are bare steel or zinc plated gold.

## Jeep® XJ Cherokee BombProof™ Motor Mounts

The Jeep® XJ Cherokee has become a very popular vehicle for serious 4-wheeling, and folks are equipping them with big tires, lockers, deep gearing and more torque. The factory motor mounts are not up to the task of these additions, and failure of the stock mounts is causing several problems. With the uni-body design, polyurethane motor mounts transfer too much vibration, so M.O.R.E. took on the challenge and solved the problem with these Torsion rubber style BombProof motor mounts. Zinc plated gold.

JM600\* .....1987-2001 Jeep® XJ Cherokee with 6-CYLINDER (4.0L) engines.

\* Some increase in engine vibrations may be noticed



## BombProof™ Block Brackets

M.O.R.E. has the answer for the common 4.0L problem of either shearing the bolts or the bolts falling out of the factory block brackets, possibly causing damage to the block. These new brackets use existing threaded holes in the block and with most applications will grab 4 additional holes. All Brackets come Bare Steel. May not work with some aftermarket headers.

- BBXJ9101.... 1991-2001 XJ 4.0L Engine
- BBYJ9195.... 1991-1995 YJ 4.0L Engine
- BBTJ9799.... 1997-1999 TJ 4.0L Engine
- BBTJ0006.... 2000-2006 TJ 4.0L Engine.

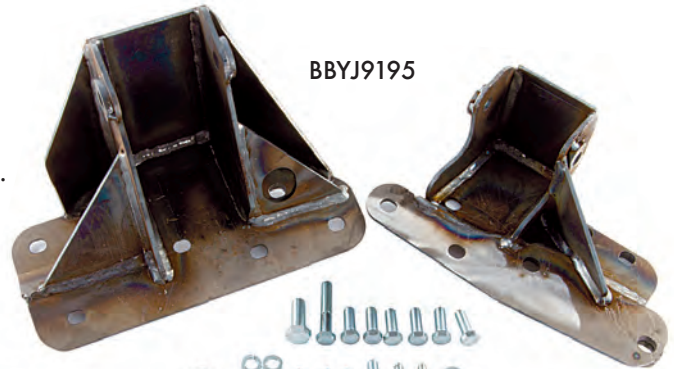

BBYJ9195



BBTJ9799



BBTJ0006

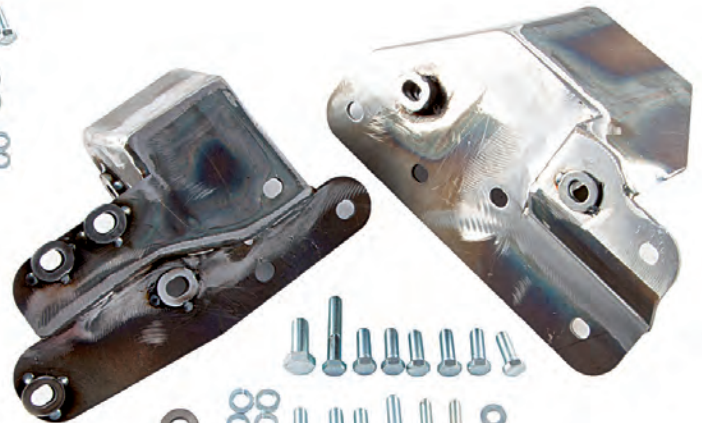

BBXJ9101



# Jeep® CJ Frame Reinforcing Plates

Jeep® CJ frames are not known for their strength. The stock frame is marginal at best for mild off road use. Introduce serious 4-wheeling with lots of twisting, wide axles, big tires, and more torque than stock, and you have a recipe for frame cracks and breakage. Reinforce the frame of your Jeep® CJ with these 3/16" thick steel plates. Pre-punched holes line up perfectly, and are cut to contour the frame. Weld them on the outside of the frame and add serious strength to the stock weak design. They can be used to repair broken frames, or installed on good frames to help keep them in good condition, before they break! Available for the front or rear of the Jeep® CJ. Bare steel, welding and fabrication skills required.



FP200.....1976-1986 Jeep® CJ-5, CJ-7. REAR. (will fit CJ-8 but will not extend all the way to the rear cross member). Will not fit 1972-1975. The rear plates are 3-1/2 feet long. They start at the rear body mount outrigger and go up over the rear axle to the rear cross member. The rear plates also come with two lower plates to reinforce the shackle hanger area of the frame. 4 piece set.



FP300.....1976-1986 Jeep® CJ-5, CJ-7, CJ-8. FRONT. (can fit 1972-1975 with minor mods.) These are 5 feet long, flat, starting at the front bumper and go back past the first body mount outrigger. You must remove the body mount outrigger, install the frame plate, then reinstall the outrigger. If this procedure is too complex, simply cut off the frame plate at the first outrigger, and weld it on! Two piece set.



RFP7686.....1976-1986 Jeep CJ Rear frame plate. Reinforce that weak CJ rear frame with this 3/16" thick plate. Weld this on to strengthen your frame in while you frame twists and flexes on that aggressive trail. These are not cross members, these are frame plates Only

# Jeep® YJ Frame Reinforcing Plates

RFP8795.....1987-1995 Jeep YJ Rear frame plate. Reinforce your YJ rear frame with this 3/16" thick plate. Weld this on to strengthen your frame in while you frame twists and flexes on that aggressive trail. These are not cross members, these are frame plates Only.





# Steering Correction Kit for Jeep® YJ Wranglers

M.O.R.E. has developed this revolutionary steering system for 1987-1995 Jeep® YJ Wranglers with spring over axle (S.O.A.) suspensions systems. This system is the answer to your steering problems. Designed for full suspension travel, without bind. It works with stock offset wheels, or after market. Simple bolt on design, no welding required. It will work with stock leaf springs over the axle, or, up to 2.5" lift springs over the axle. The stock Tie Rod and Drag Link are not up to the task of handling the angles or loads placed on them with the S.O.A. set-up, and they are very vulnerable to off road obstacles. Bump steer is a common complaint that we hear from customers, and worn-out Tie Rods and Drag Links are very common. M.O.R.E.TM found it necessary to replace the stock set-up with all new components of a totally different design. We start with a new Tie Rod and Drag Link made of 1" O.D.x.219 wall, D.O.M. steel tubing, threaded for left and right Rod Ends (sometimes called Heim Joints) on both ends. The Tie Rod bolts on top of the knuckles for increased clearance. The Drag Link bolts on top of the dropped pitman arm and parallels the ground, over the leaf spring to the passenger side knuckle. At that point, our special bracket bolts\* to the knuckle with six grade 8 bolts. Our raised and well reinforced Trac Bar Bracket keeps the Trac Bar (Slip-Loc™ or DoubleJointed™, OEM will not fit) parallel to the Drag Link for zero bump steer. This system does not come with steering stabilizer (shock) mounts. Bare steel, no powder coating. Zinc plating available on a special order basis. \*Minor grinding, drilling and tapping of holes is required.

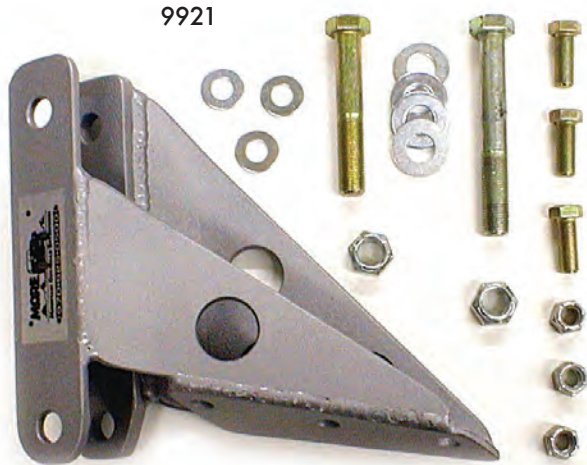

9921

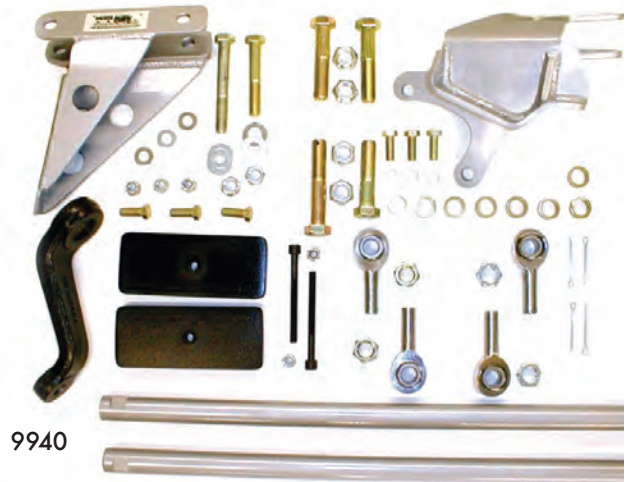

9940



9923



9922

9921.....Trac Bar Bracket. Raised and well reinforced. This bracket only works with M.O.R.E. DoubleJointed™ or Slip-Loc™ Trac Bars. Will not fit OEM (stock) trac bar.

9922.....Dropped Pitman Arm. Drilled for 5/8" Rod End.

9923.....Bracket-P/S knuckle. Bolt on, drilling and tapping of knuckle required. No hardware or instructions provided.

9924.....Tie Rod/Drag Link assembly, with Rod Ends and Jam Nuts.

9925.....Hardware Kit. All bolts, nuts, spacers, cotter pins, and instructions.

9930.....Steering Correction Kit - STAGE ONE Includes: Knuckle Bracket (#9923), Tie Rod & Drag Link assembly (#9924), and Hardware Kit (#9925).

9940.....Steering Correction Kit - STAGE TWO Includes: Stage One components plus, Trac Bar Bracket (#9921), and Dropped Pitman Arm (#9922)

Note: All above parts are bare steel, no powder coating. Zinc plating available on a special order basis.



# Steering Box Mount H.D.

This Heavy Duty steering box bracket fits 1976-1986 Jeep® CJ-5, CJ-7, CJ-8 vehicles with power steering. The stock stamped steel steering box mounts are not up to the task of holding the steering box in place. Even when you add a Steering Box Brace (see below), big tires, locking differentials and big rocks can cause the stock mounts to be torn off the frame. Made from 1/2" and 3/8" thick steel. Sold bare steel, or zinc plated gold. All mounting hardware included. SB7686-1 and SB7686-1Z moves steering box forward 1-1/4" so the drag link and the tie rod aren't over the top of each other and interfere each other.

SB7686Z fits Wrangler CJ, Zinc Plated

SB7686-1Z fits Wrangler CJ, Zinc Plated  
Moves Steering Box 1-1/4" forward

SB8795-1Z fits Wrangler YJ, Zinc Plated,  
Moves Steering Box 1" forward and 1/2" down.

SB7686 fits Wrangler CJ, No Plating

SB7686-1 fits Wrangler CJ, No Plating.  
Moves Steering Box 1-1/4" forward

SB8795-1Z

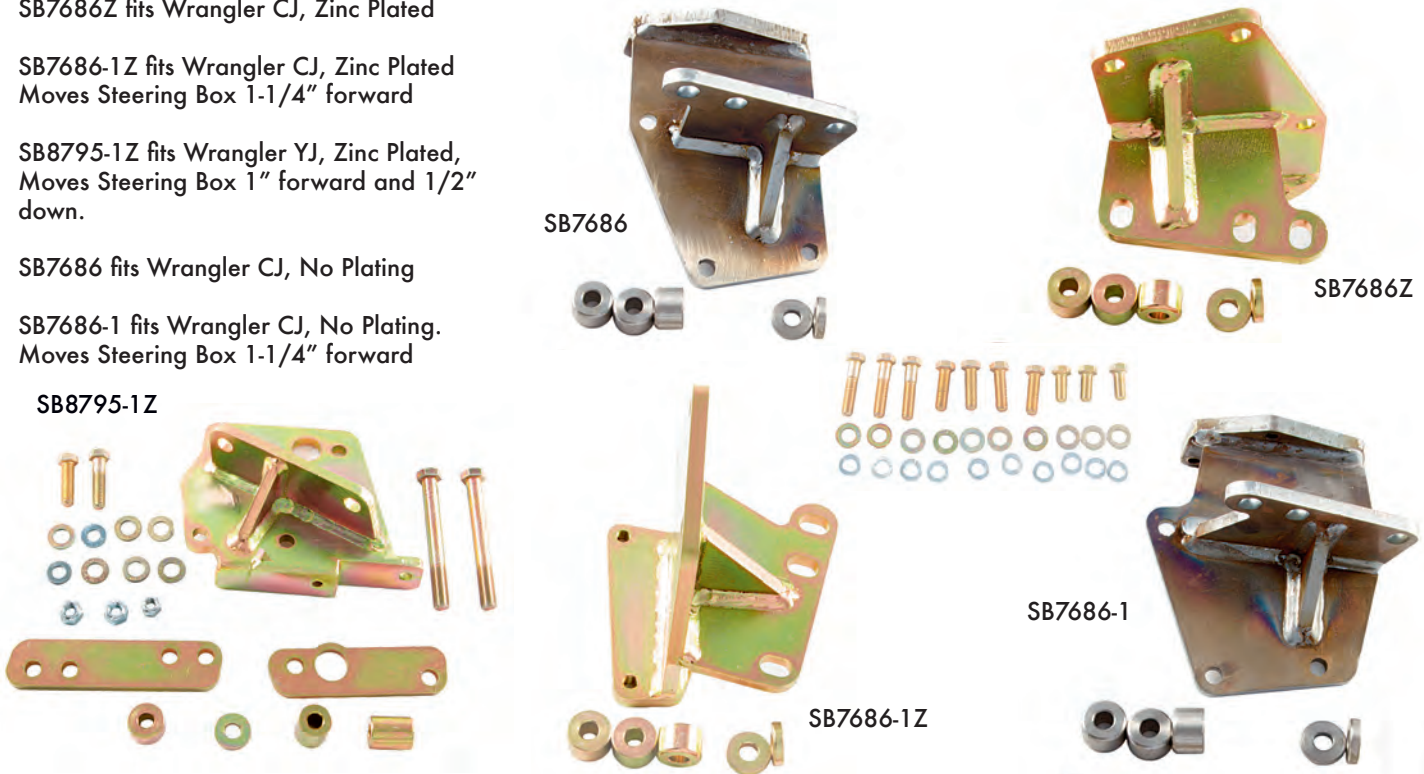

# Steering Box Braces

One of the most commonly overlooked areas on the Jeep® vehicle is the steering box mount. The stock method of mounting is not up to the task of clamping the box to the frame when larger tires, locking differentials and tough trails are mixed. Reinforce the steering box mount on your Jeep® with this super strong, easy to install Steering Box Brace. If you have installed tires any larger than stock, this is a must have item. The best insurance you can install to help prevent the box from being torn off the frame. Made from 1" O.D.x.120w steel tubing, powder coated gray. The clamp is zinc plated gold and all hardware is included. Note: Fits power steering boxes only!

SB9037 1976-1986 Jeep® CJ-5, CJ-7, CJ-8  
 SB9037W 1987-1995 YJ Wrangler  
 SB9037TJ 1997-2002 Jeep TJ Wrangler  
 \*Will not fit 2003 and up  
 SB9037XJ For XJ Cherokee 1984-2001.  
 SB9037C Clamp Only Make you own Steering brace.

SB9037TJ03 Steering Brace for 2003-2006 Jeep® TJ Wranglers. So if your vehicle is sporting tires larger than stock, this steering brace is a much needed item! Comes powder coated grey.





# H.D. Tie Rod/ Drag Link for CJs

You can now replace the stock wimpy tie rod and drag link on your 1972-1986 Jeep® CJ with our Heavy Duty Tie Rod / Drag Link kit. Manufactured from 1" O.D. x .219 wall D.O.M steel tubing, threaded on each end for 5/8 left and right rod ends, with wrench flats on each end. The rod ends are race-car quality, Teflon® / Kevlar® lined, self lubricating and the alloy steel heat treated body is plated for durability. They will mount under or over the knuckles, and you must drill the stock tapered hole to a straight 5/8" hole. Jam nuts and grade 8 hardware provided. Bare steel, no paint. Zinc plated rods available on a special-order basis.

9926.....1982-1986 CJ's. Tie Rod & Drag Link Dana 30

9927.....1982-1986 CJ's. Drag Link only Dana 30

9928.....1972-1981 CJ's. Tie Rod & Drag Link. Dana 30

9929.....1972-1981 CJ's. Drag Link only. Dana 30

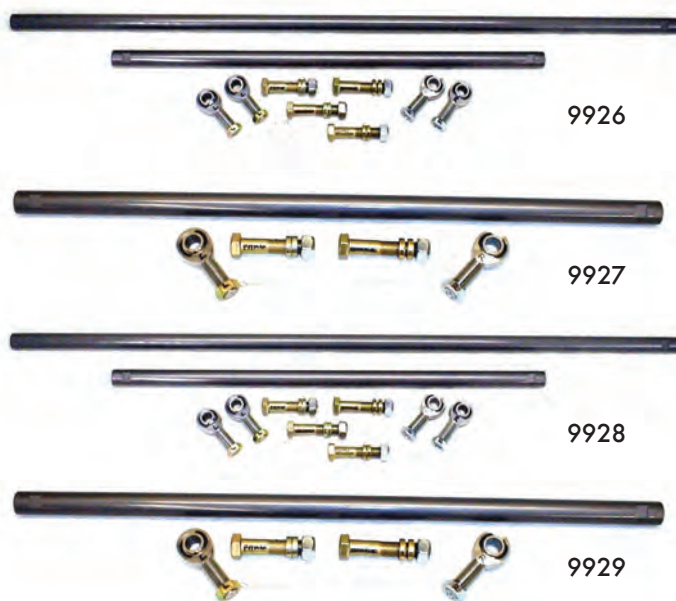

## Traction Bar

Have you got a Jeep® CJ or YJ with the rear leaf Springs Over the Axle (S.O.A.), and the rear spring wrap is causing problems? We have the answer for you. This H.D. Traction Bar will prevent all spring wrap, without limiting travel or flexibility. The Johnny Joint® mounted shackle attaches to the transfer case crossmember and converts the twisting forces of the axle into up and down motion at the front of the Traction Bar. The shackle at the front of the bar allows the axle and traction bar to move fore and aft, but does not allow the up and down motion that the axle wants to create. Thus, no more spring wrap! Comes with axle mounting brackets that must be welded on the axle housing.

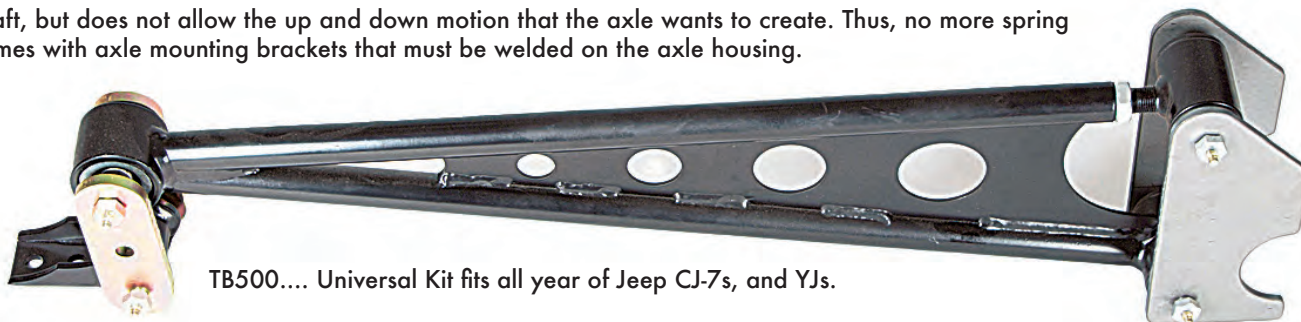

TB500.... Universal Kit fits all year of Jeep CJ-7s, and YJs.

## Yoke for Ford 8.8

M.O.R.E. now stocks the special yoke needed to adapt the Ford 8.8 rear axle pinion flange to the stock XJ or YJ (1310 series) U-joint. This bolts on the Ford flange and allows you to install your XJ or YJ rear drive shaft directly to it.



For Ford 8.8 in a Jeep XJ, YJ & TJ

## Emergency Brakes Cables

Have you installed a Ford 8.8 rear axle in your Jeep® XJ or YJ and need to have the correct cables for the emergency brake? We have the correct cables in stock. The quality is outstanding and they are very rugged and ready for your offroad abuse. Pair.



EB1 \*.....1987-1995 Jeep® YJ Wrangler with Ford 8.8 (disc brake rear axle). \* Call if you have a 1987-1990 YJ

EB2.....1984-1996 Jeep® XJ Cherokee with Ford 8.8 (disc brake rear axle).

EB3.....1997-2001 Jeep® XJ Cherokee with Ford 8.8 (disc brake rear axle).

EB4.....1997-2006 Jeep® TJ Wrangler with Ford 8.8 (disc brake rear axle).

## Universal Tube Clamp

Use this Universal Tube Clamp to mount your CB, Fire Extinguisher or anything you can imagine. Outside diameter tubing.





# Jeep® YJ Wranglers/Shock Mounts

## LONG TRAVEL FRONT SHOCK HOOP

Designed for the Jeep® YJ front to allow you to install a longer front shock (for more wheel travel) and convert the shock to a loop-style top mount. You must cut the stock shock tower, then bolt this hoop to the existing hole in the back side of the stock tower. Welding may be necessary in some cases. Sold bare steel.

SH300.....1987-1995 YJ front. Pair.

## LONG TRAVEL REAR BRACKETS

Now you can install longer rear shocks on your Jeep® YJ Wrangler without cutting into the body tub! Just drill one hole per side and bolt these upper brackets to the stock shock mount. Works without a body lift and allows the use of shocks 2 inches longer than stock. 9950.....1987-1995 YJ rear. Pair.



9950



SH300



# Jeep® CJ/Shock Mounts

## LONG TRAVEL SHOCK MOUNT CAGE

SH100\*.....1972-1986 CJs.

Shock Hoop Kit. Are you a welder/fabricator but don't have a tube bender or the time to cut out and drill all of the necessary tabs to build your own shock hoops? Then this kit is for you. It includes two 1-1/2 dia. tube hoops, and all the tabs and braces to build your own dual shock hoops. Universal kit can be adapted to several different vehicles.

## SHOCK HOOP KIT

SH200..... This shock mount cage will bolt on (82-86 frames), and allow the use of shocks up to 13" stroke with only a 3" suspension lift! Designed to be an easy install, minor inner fender well trimming is all that is necessary. It's design incorporates a brace across the engine. Fits 6 and 8 cylinders.

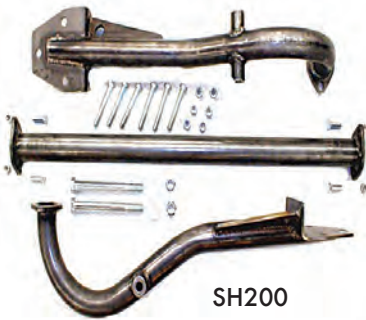

SH200

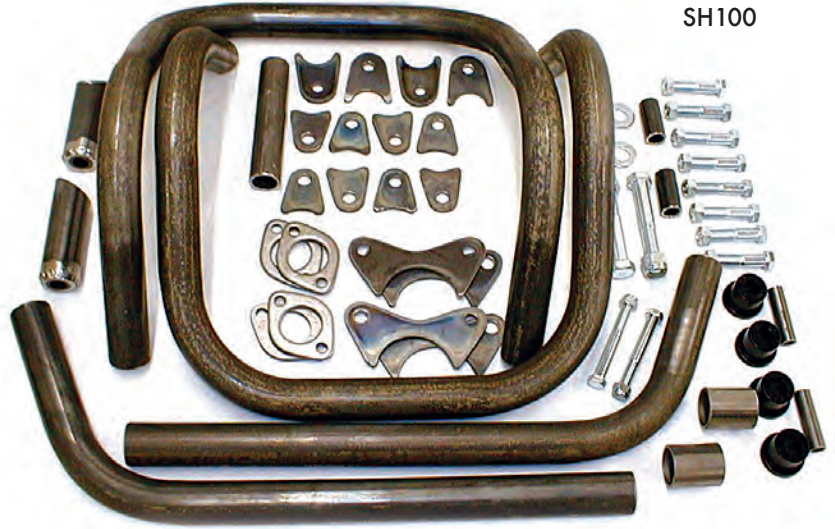

SH100

## JK LIGHT BRACKET

JKLB....JK Light Bracket fits all JK models. Includes rubber backing to protect your paint. Powder Coated Black. Light not included.



# Universal Shock Mounts

## UNIVERSAL WELD ON SHOCK MOUNTS

98200...Weld on. Designed for axle housing, this 3/16" formed bracket has a 1/2" hole for the shock. This style mounts the shock with the bolt parallel to the housing. Sold each.



## UNIVERSAL WELD ON SHOCK MOUNTS

98201.....Universal, weld on. Designed for the Jeep® XJ rear axle, but can be used in several different applications. This style mounts the shock at a 90 degree angle to the housing. It comes with the shock mounting pin. Sold each.





# JK Dual Battery Tray

JKDBT0712.... For 2012 to current Jeep JK.  
JKDBT0709.... For 2007-2011 Jeep JK.

Never worry about a dead battery out on the trail with our new MORE Dual Battery tray, which will accommodate 2 Optima series 34 and 34/78 or the OEM batteries side by side in the stock location. This easy Bolt In kit Bolts into existing holes (No Drilling Required) comes powder coated black and retains OEM air filter box. This kit does not include wiring or batteries.



# JK Front Skid Plate

JKFSP07 .... This JK Front Skid Plate bolts on to your 2007 to current Jeep Wrangler and is designed to protect your electronic sway bar disconnect and your steering components. This Jeep Jk Wrangler Front Skid Plate is made out of 3/16" plate steel and powder coated black. Easy bolt on install.

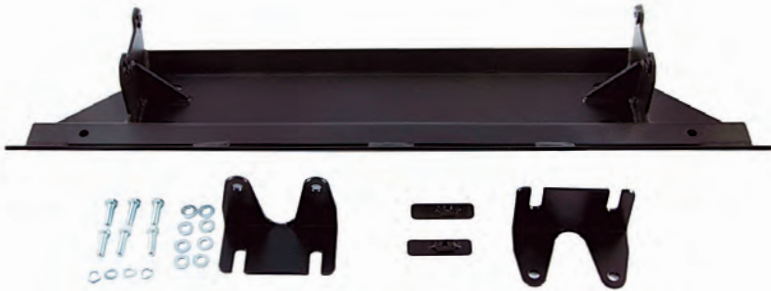

# JK T-Case Skid Plate

JKTCSP07 .... This JK Transfer Case Skid Plate bolts on to your 2007 to current Jeep Wrangler and is designed to protect your transfer case. This Skid Plate is made out of 3/16" plate steel and powder coated black. Easy bolt on install.



# JK Muffler Skid Plate

JKMSP .... Mountain Off Road is now manufacturing Muffler Skid Plate for the 2007 and newer Jeep JK Wrangler. Protect your expensive muffler when you grind over those rocks. Manufactured out of 3/16" plate steel. Fits stock mufflers and Magnaflow mufflers. Easy Install. Powder coated black.



# JK Evap Skid Plate

JKESP07 .....For 2007-2011 Jeep JK's Wranglers  
JKESP12 .....For 2012 to current Jeep JK's Wranglers

We are now manufacturing a skid plate for the evap canister on Jeep JK 2007 - current. Protect that expensive evap canister while grinding over those rocks. Laser cut out of 3/16 plate and powder coated for a durable finish.

JKESP07

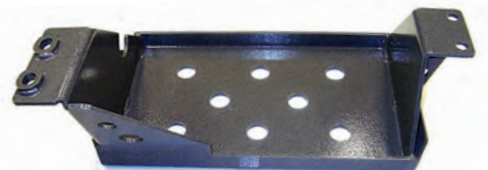



# Jeep® TJ/YJ/JK, Ford Super Duty, GM Hide-A-Step

It is now easier to get into the seat of your large - tired jeep with our Hide-a-step. The step gains you 11" of height from the door sill and is easily removable. JK rear door application.

- \*\* Quick Disconnect when Off-Roading
- \*\* Easy Install
- \*\* Class IV Zinc Plating for hazards winter conditions
- \*\* Finally an affordable step for your large tires

Pull 2 quick disconnect pins and the HIDE-A-STEP will remove easy for when you want to go wheelin.

Does not fit Sahara steps.

Hide-a-step for your GMC or Chevy truck will not fit passenger door on diesels from 2011-current.

- Hide-A-step: TJ..... TJST (Silver), TJSTB (Black)
- Hide-A-step: YJ..... YJST (Silver), YJSTB (Black)
- Hide-A-step: JK..... JKST (Silver), JKSTB (Black)
- Hide-A-step: GM....GMST99 (Silver), GMST99B (Black)
- Hide-A-step: Ford Super Duty..... FOST99 (Silver), FOST99B (Black)
- Rear Door Application..... JKST07R (Silver), JKST07RB (Black)



## ARB97 Mount

Mount your ARB CKMTA12 twin air compressor or CKMA12 single stage compressor or CKSA single stage compressor under your Jeep® TJ hood. Uses factory motor 4.0L for location of our bracket. Fits Jeep® TJ's 1997 to 2006 Wranglers.



## ARB Compressor

ARB's new CKMTA12 twin on-board compressor kits were designed to fill the market need for a compact sized yet high-volume compressed air source to suit the high volume airflow needs of most air powered tools as well as fast airing up of your tires. Rapid inflation of small, medium and large tires. Air tools rated up to 85LPM continuous supply. Bracket sold separate.



## ARB07 Mount

Mount your ARB CKMTA12 twin air compressor or CKMA12 single stage compressor or CKSA single stage compressor under your Jeep® JK hood. Use factory location for easy bolt up. Fits 2007 Jeep JK Wranglers to current.

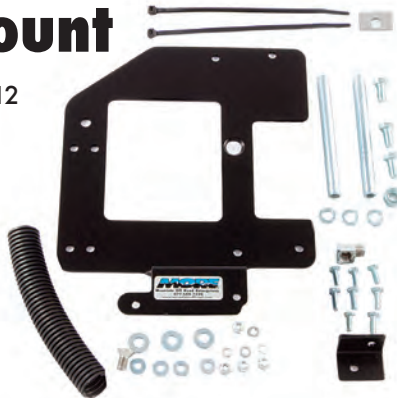

## Universal ARB Bracket

ARB101.... ARB Universal Mounting Bracket. Mount your ARB CKMTA12 twin air compressor under your vehicle. This universal bracket will fit anywhere on any vehicle with a clear opening of 7" wide X 10" long X 5/8" Tall. The compressor is 4-1/2" tall.

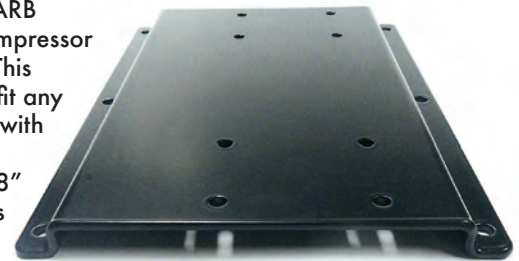

HSRH11

## Receiver Hitch Hide-A-Step

A spring operated step that retracts up and out of the way. Simply step on it and it comes down for use, remove your foot and it retracts. Has dimpled top for traction.

- This HIDE-A-Step slides into your 2" receiver hitch
- \*\* Quick Disconnect when Off Roadin
- \*\* Easy Install
- \*\* Class IV Zinc Plating for hazards winter conditions
- \*\* Finally an affordable Rear step for your large tires

General Purpose Hide-A-step... HSRH11 (Silver)  
General Purpose Hide-A-step... HSRH11B (Black)





# Axle Mounting Hardware

## LEAF SPRING MOUNTS

These weld on spring mounts are 2.5" wide, 7" long (anti-wrap design), have 3 holes for the center bolt so you can place the axle where you want to. H.D. 1/4" thick steel, Sold in pairs.

98103.....Specially designed for YJ front housings.  
 98104.....2-1/2" radius.  
 98105.....2-3/4" radius  
 98106.....3" radius.  
 98107.....3-1/4" radius.

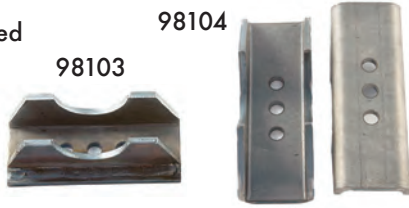

## WHEEL SPACERS FOR 8.8 SWAP

M.O.R.E.™ has available "Lug Centric" wheel spacers for your 8.8 which are 7/8" thick.

WS5450... 5 on 4.5" bolt pattern sold in prs.

LN050... 1/2" Lug Nuts, for 7/8" wheel spacers.



# Jeep® XJ/TJ/YJ 8.8 Rear Axle Upgrade Kit

98700..... Are you having trouble with the stock Dana 35 rear axle in your Jeep® XJ ,TJ or YJ? If you have installed tires larger then stock, chances are that you could be. We have found the answer, and it is a very simple swap. The Ford 8.8 rear axle assembly from a Explorer is super heavy duty, and is very simple to install. It's features are as follows:

- Same lug nut bolt pattern.
- Disc brakes (95 & newer).
- 31 spline axle shafts.
- 8.8" diameter ring gear (D35 is 7.5").
- 120% stronger then D35.
- Only 20 pounds more then D35.
- Trac-loc differential stock.
- 3-1/4" diameter tubes (strong!).

You are required to find the complete rear axle assembly from a 95 or newer Ford Explorer, from a salvage yard. Then, remove (torch) the Ford mounts (spring, & anti-sway bar). You may also need to change the gear ratio as most Explorers have 3:73. The width is almost the same. It is 1-1/4" narrower then the D35. This is a very minor draw back, and will work if you have wheels with less back-space then stock. If you have stock wheel back-spacing, then we have 7/8" wheel spacers available (see above). We also have the correct cables for the parking brake that are a direct bolt on.



# Jeep® JK Oil Pan/Transmission Skid Plate

JKOPSP.... Mountain Off Road is now manufacturing and stocking JK Oil Pan/Transmission skid plate for the 2007 and newer Jeep JK Wrangler. Protect your investment when you grind over those rocks and have confidence that all is OK. Easy install for standard and automatic transmissions. Powder coated black.

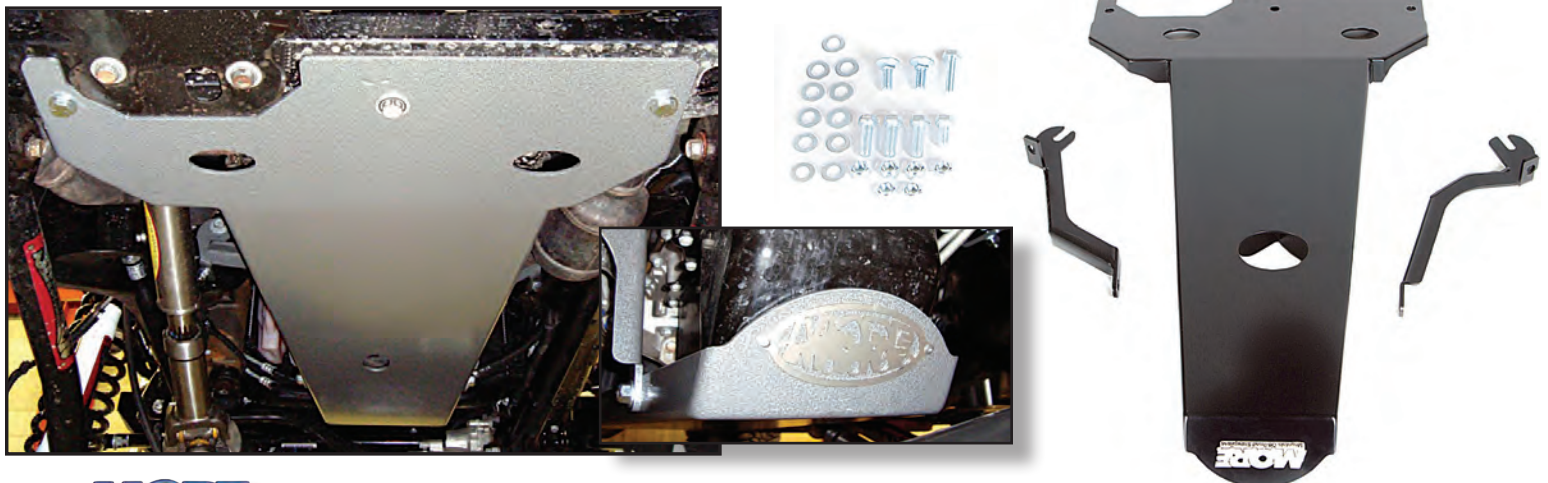



# Terms/Policies/General Information:

**FIT and TOLERANCES:** All parts that M.O.R.E.™ sells are the results of countless hours of research, testing, fitting and refining. Jeep® vehicles have a wide tolerances from vehicle to vehicle. In addition to the factory tolerances, most people install aftermarket equipment (such as bumpers, winches, springs etc.) M.O.R.E.™ has done the best job we can to insure that our parts fit with all of the possibilities. However, you may find it necessary to grind, elongate, bend, or force the parts that you purchase to fit on your rig. Please use common sense when installing these parts, and understand that if you modify them in any way, shape or form, they are not returnable!

**ORDERING:** Please order by phone, fax or at [www.mountainoffroad.com](http://www.mountainoffroad.com). Our business hours are Mon.— Fri. 8:00 AM to 5:00 PM mountain time zone. Our Phone number is 877-533-7229, fax is 888-698-5337. If you choose to mail-in (US Postal Service) your order our address is M.O.R.E., Post Office Box 690, Delta, CO 81416.

**TERMS OF PAYMENT:** Payments must be in U.S. funds only. We accept Visa, MasterCard, American Express, Pay Pal and Discover Cards. If you choose to mail in your order send a cashiers check or money order plus shipping cost to get the products to you. No personal checks. No open accounts. Colorado residents add 2.9% sales tax.

**SHIPPING:** We ship by UPS, some items can be mailed via US Postal Service. There will be a handling/packaging fee added to all orders.

**SERVICE:** M.O.R.E.™ has always prided itself with quick service. We attempt to ship all orders within 2 days from time the order is placed. Due to the specialty of some of our items there may be a delay of 1-2 weeks for delivery.

**DAMAGE CLAIMS:** All orders are carefully packed, however, mishandling by the carrier can result in damage. The carrier has the responsibility for the shipment from the time it leaves our warehouse until it is delivered to you. All claims for lost or damaged goods should be reported to the carrier, not to M.O.R.E.™ LLC.

**RETURNS:** No returns will be accepted without prior permission from M.O.R.E.™ LLC. You must call for a Return Goods Authorization (RGA) number. Merchandise must be returned prepaid and insured. A claim must be made within 30 days from receipt of merchandise. The original invoice or a copy with the RGA number written on must accompany all returns. A 20% restocking fee will be charged on all parts returned for credit or refund unless merchandise is proven to be defective or was shipped wrong by M.O.R.E.™ LLC. No merchandise will be issued credit or refund if it has been installed, modified, used in any way or is in unsalable condition.

**M.O.R.E.™ "ROCKPROOF" LIFETIME WARRANTY:** All M.O.R.E.™ products purchased directly by the consumer from a M.O.R.E.™ Authorized Dealer / Distributor, are protected by a ROCKPROOF LIFETIME WARRANTY if the product fails to the original retail purchaser for as long as they own the vehicle. Rubber, urethane and the product's finish (powder coat or other finishes), are warranted to be free from defects in materials and workmanship, but are considered to be wearable items and are not covered under the ROCKPROOF LIFETIME WARRANTY. Products that have been altered, modified or installed on vehicles other than those recommended by M.O.R.E.™, damage due to improper installation, fire or accident, are not covered under the ROCKPROOF LIFETIME WARRANTY. M.O.R.E.™ obligations under this warranty are limited to the repair or replacement, at M.O.R.E.™ discretion, of the defective product. All cost of the original installation, removal or reinstallation, consequential or incidental, or damages and shipping charges are expressly excluded from this ROCKPROOF LIFETIME WARRANTY. No warranty product will be accepted without a Return Goods Authorization (RGA) number from M.O.R.E.™ LLC. You must provide a copy of the original receipt showing the name of the retail establishment that you purchased the product from, including the date and price paid. Then return the product, freight prepaid and insured, as instructed by the original M.O.R.E. Authorized Dealer / Distributor where you purchased the product.

**PRODUCT DISCLAIMER:** Modification of your vehicle to enhance performance with parts sold by M.O.R.E.™ LLC. may create a dangerous condition which could cause serious bodily injury, and the buyer hereby expressly assumes all risks associated with any such modifications. All parts sold by M.O.R.E.™ LLC. are for racing or off road use only. Mountain Off Road Enterprises LLC. will not accept responsibility for personal injury or property damage arising from the failure of any parts manufactured or sold by M.O.R.E.™ LLC.

Specifications are subject to change without notice. This catalog supersedes all previous catalogs. A separate price sheet should accompany this catalog.

Jeep®, AMC®, CJ®, YJ®, TJ®, XJ®, LJ®, JK® Wrangler®, Cherokee®, Quadra-Trac® are registered trademarks of DaimlerChrysler. M.O.R.E.™ is not affiliated with DaimlerChrysler.

Johnny Joint® is a registered trade mark of Currie Enterprises. M.O.R.E.™, BombProof™, S.R.S.™, SlipLoc™, DoubleJointed™, RockProof™, are trademarks used by Mountain Off Road Enterprises, Inc. This catalog, and the M.O.R.E.™ logo are copyright©, 2013.





# MORE

**Mountain Off-Road Enterprises**

**Post Office Box 690 - Delta, Colorado 81416**



Like us today on Facebook

## Dear Valued Customers,

**Mountain Off Road Enterprises, Inc is striving to meet the needs of the Jeep enthusiast. Our products are the result of over 40 years of experience with Jeep vehicles. We use them for rock crawling, camping, fishing, hunting, exploring and even competing.**

**We enjoy building and improving our own Jeeps as much as driving them. New ideas are always being tested and refined. When those ideas make it to a finished product, you can be sure that they are made only from the highest quality materials and our workmanship will be outstanding. Every product that we make or sell is made right here in the USA!**

**Thank you for your interest in Mountain Off Road Enterprises. We look forward to helping you build the Jeep that you have ALWAYS wanted. Check out our website at [www.mountainoffroad.com](http://www.mountainoffroad.com) for the latest products or to order online.**

**Scott**

BLACK BEAR PASS  
12,240 FEET



[www.mountainoffroad.com](http://www.mountainoffroad.com)

**Toll Free 877-JEEP-A2Z or 877-533-7229**