

TECHNICAL DRAWINGS: CP ACCESS WINDOWS

CP ACCESS WINDOWS UNPROTECTED TECHNICAL DRAWINGS 2 MODULE

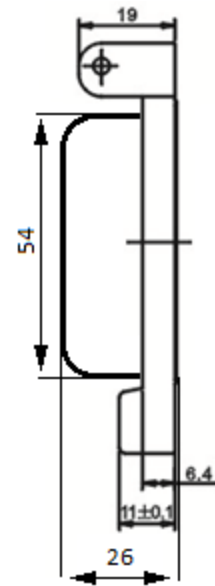

4 MODULE

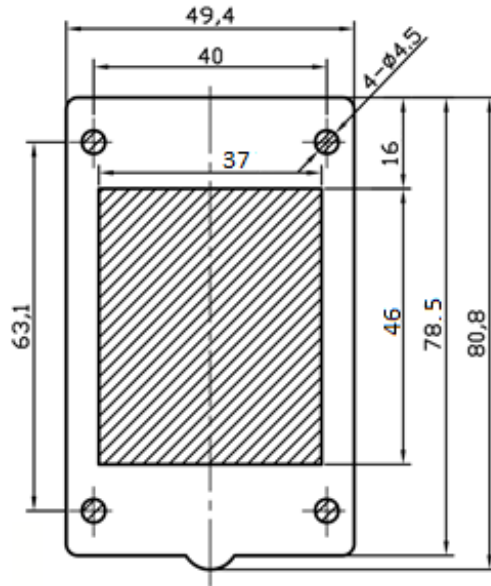
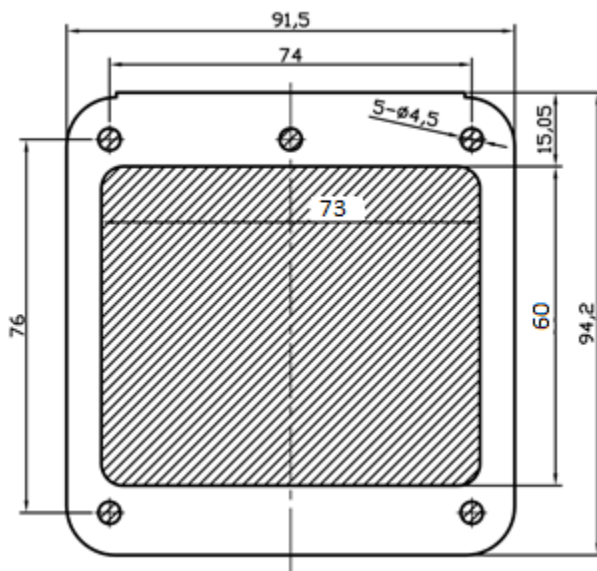

6 MODULE

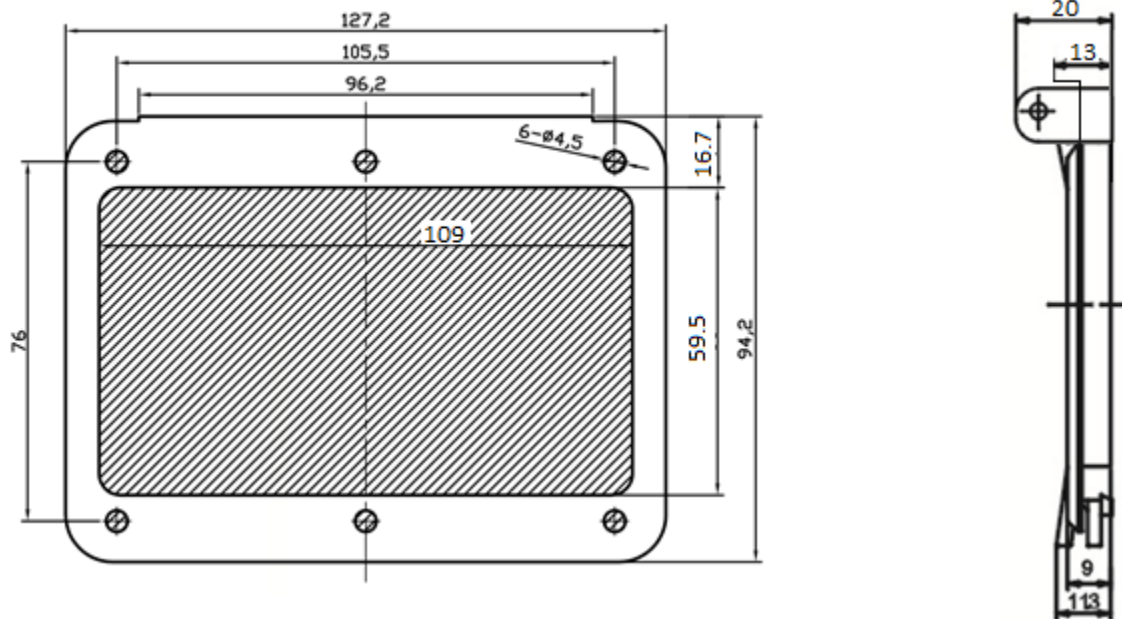

8 MODULE

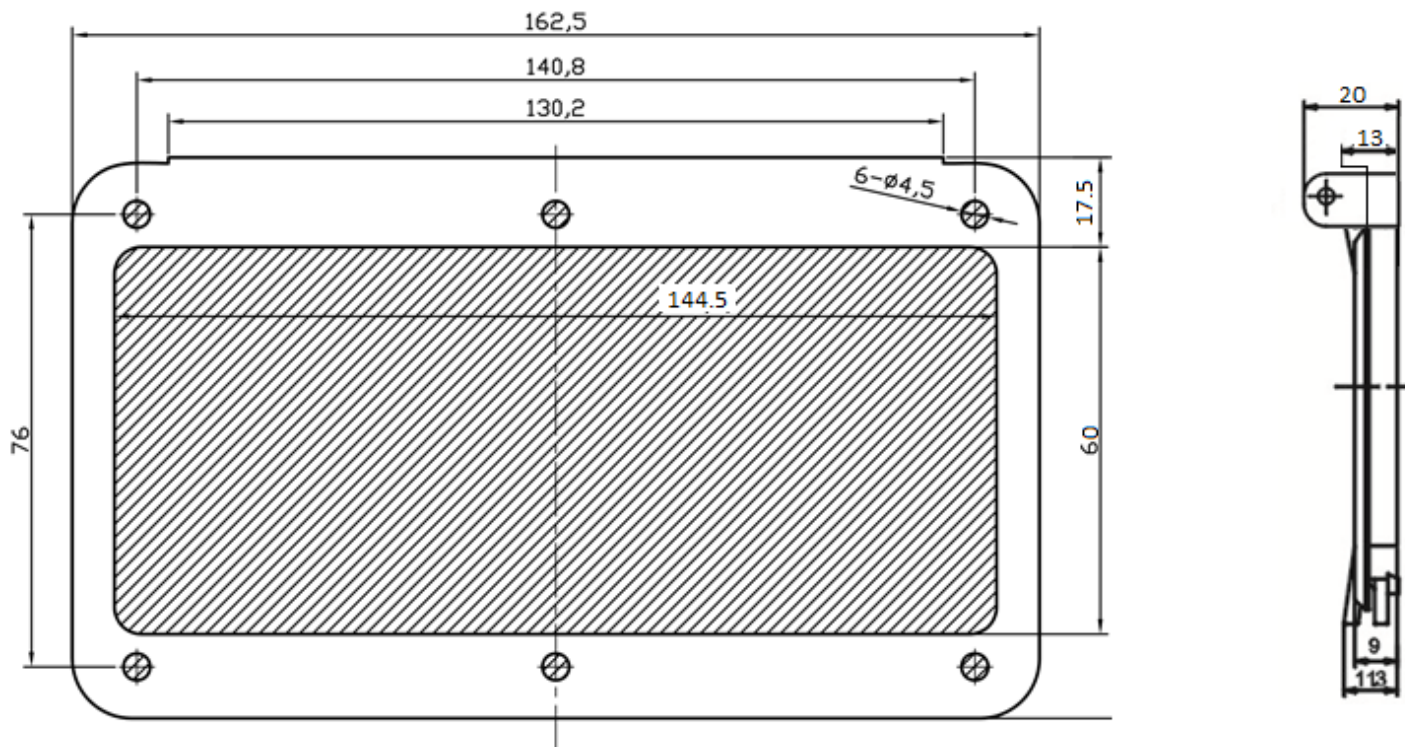

12 MODULE

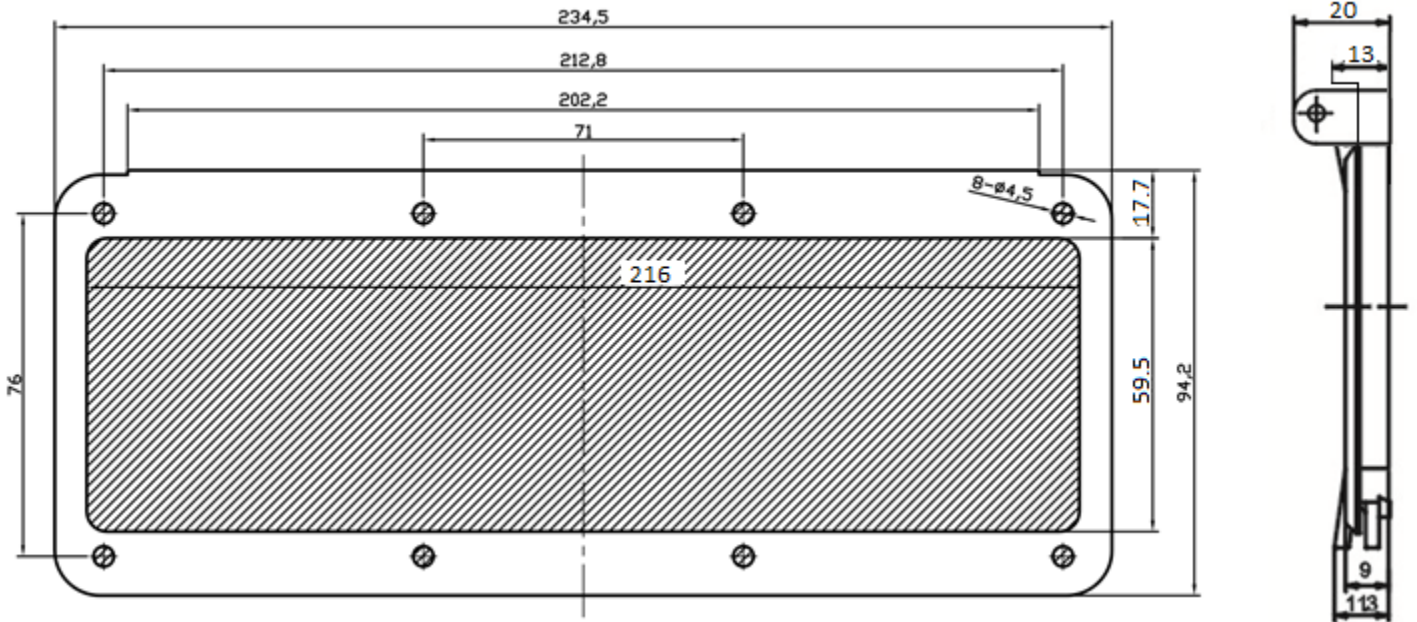

18 MODULE

