

PORTABLE AUTOMATIC ICE MAKER

User Manual

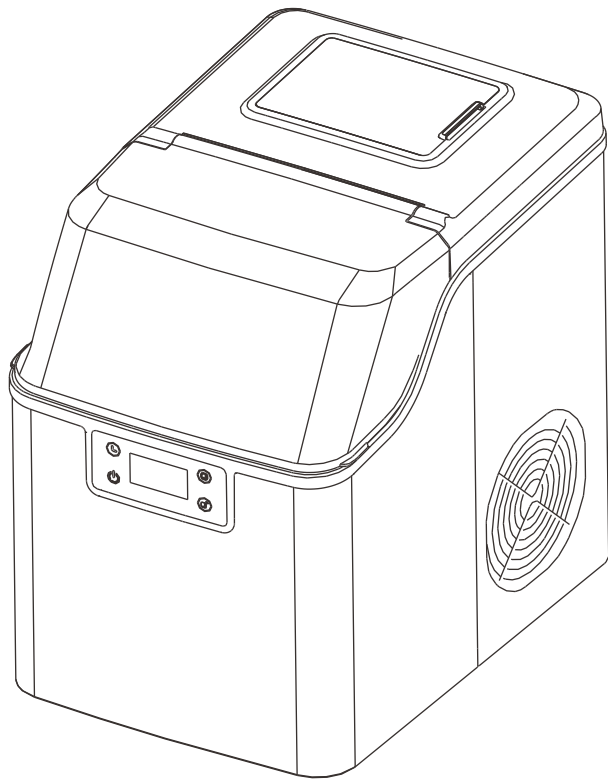

HZB 20AF/S

TABLE OF CONTENTS

| | |
|---|-----|
| IMPORTANT SAFETY INSTRUCTIONS | 2 |
| PREPARING YOUR ICE MAKER FOR USE | |
| IMPORTANT SAFETY TIPS..... | 3-4 |
| PACKING LIST | 4 |
| GETTING TO KNOW YOUR UNIT | 5 |
| OPERATING PROCEDURES & MAINTENANCE | |
| UNPACKING YOUR ICE MAKER..... | 6 |
| CONNECTING YOUR ICE MAKER..... | 6 |
| CLEANING AND MAINTAINING YOUR ICE MAKER..... | 6-7 |
| USING YOUR ICE MAKER | 8 |
| <i>Automatic self-cleaning program</i> | 9 |
| TROUBLESHOOTING..... | 10 |
| TECHNICAL PARAMETERS & CIRCUIT DIAGRAM | 11 |

IMPORTANT SAFETY INSTRUCTIONS

Your safety and the safety of others are very important.

We have provided many important safety messages manual and your appliance. Always read and obey all safety messages.

This is the safety alert symbol:



All safety messages will follow the safety alert symbol and the word “DANGER” or “WARNING”.

 **DANGER**

 **WARNING**

These words mean:

You can be killed or seriously injured if you don't immediate follow instructions.

All safety messages will tell you what the potential hazard is, tell you how to reduce the chance of injury, and tell you what can happen if the instructions are not followed.

PREPARING YOUR ICE MAKER FOR USE

IMPORTANT SAFETY TIPS

When using electrical appliances, basic safety precautions should be followed to reduce the risk of fire, electric shock, and injury to persons or property. Read all instructions before using any appliance.

- Do not operate this, or any other appliance with a damaged cord. Connect to properly polarized outlets only. No other appliance should be plugged into the same outlet. Be sure that the plug is fully inserted into the receptacle.
- Do not run the power cord over carpeting or other heat insulators. Do not cover the cord. Keep cord away from traffic areas, and do not submerge in water.
- We do not recommend the use of an extension cord, as it may overheat and become a risk of fire. If you must use an extension cord, use No.14 AWG minimum size and rated no less than 1875 watts.
- Unplug the ice maker before cleaning or making any repairs or servicing.
- Exercise caution and use reasonable supervision when appliance is used near children.
- Do not use your ice-maker outdoors. Place the ice-maker away from direct sunlight and make sure that there is at least 6 inches of space between the back of your unit and wall. Keep a minimum distance of 6 inches on each side of your unit free.
- Do not use other liquid to make the ice-cube other than water.
- Do not clean your ice maker with flammable fluids. The fumes can create a fire hazard or explosion.
- Do not tip over.
- If the ice maker is brought in from outside in wintertime, give it a few hours to warm up to room temperature before plugging it in.

WARNING: This appliance must be earthed.

- **DANGER – Risk Of Fire or Explosion. Flammable Refrigerant Used. Do Not Use Mechanical Devices To Defrost Ice Maker. Do Not Puncture Refrigerant Tubing.**



- **DANGER – Risk Of Fire Or Explosion. Flammable Refrigerant Used. To Be Repaired Only By Trained Service Personnel. Do Not Puncture Refrigerant Tubing.**

- CAUTION – Risk Of Fire Or Explosion. Flammable Refrigerant Used. Consult Repair Manual/Owner’s Guide Before Attempting To Install or Service This Product. All Safety Precautions Must be Followed.
- CAUTION – Risk Of Fire Or Explosion. Dispose Of Property In Accordance With Federal Or Local Regulations. Flammable Refrigerant Used .
- CAUTION-Risk Of Fire Or Explosion Due To Puncture Of Refrigerant Tubing;Follow Handling Instructions Carefully. Flammable Refrigerant Used.
- The ice maker should be installed in accordance with the safety standard for Refrigeration Systems, ASHRAE15. The ice maker shall not be installed in corridors or hallways of public buildings.
- If the unit is with problem need to be maintained, that replacing with like components and that servicing shall be done by factory authorized service personnel, so as to minimize the risk of possible ignition due to incorrect parts or improper service.

IMPORTANT:

The wires in this mains lead are colored in accordance with the following code:

Green or Green with a strip yellow: Grounding
 White: Neutral
 Black: Live

To avoid a hazard due to instability of the appliance, it must be placed at a even or flat surface.

PACKING LIST

| No. | Description | Quantity |
|-----|------------------|----------|
| 1 | Manual | 1 pc |
| 2 | Ice Basket | 1 pc |
| 3 | Ice Scoop | 1 pc |
| 4 | Non spill advice | 1 pc |

GETTING TO KNOW YOUR UNIT

1. Control Panel:

A. Timer/clean button

Quickly press this button once, to enter the Timer setting program; And press this button for more than 5 seconds, to enter the Cleaning program

B. ON/OFF button

When the unit is off, press this button to turn on the unit;

When the unit is making the ice cube, press this button for more than 5 seconds, the unit will switch to ice harvest process by force.

C. LCD Display window

1. Ambient temp and ice making countdown symbol: when display show <M>, ice making countdown, when display show <°F>, means ambient temp.

2. Ice cube symbol: when the symbol is rotating, the unit is making ice cube, when the symbol flash, the unit is ice harvest.

3. Automatic self-cleaning symbol display

4. ON/OFF symbol.

5. Error code E1-Ambient temp sensor breakdown. E2- water temp sensor breakdown

E- Means ice making anomaly or the refrigerant leaked

6. Lack water warning symbol.

7. Ice full warning symbol.

8. Time setting display area. When show <H>, timer unit ON/OFF, when show <M>, setting ice making time.

D. Ice making and timer reduce.

E. Ice making and timer increase.

2. Ice basket

3. Evaporator

4. Water separator pipe

5. Unit top cover

6. Cover for the water reservoir

7. Support seat for water bottle (Optional, special for the unit supplied by bottled water)

8. Hot Air Outlet

9. Water draining cap: To draining out the water from unit

10. Ice scoop

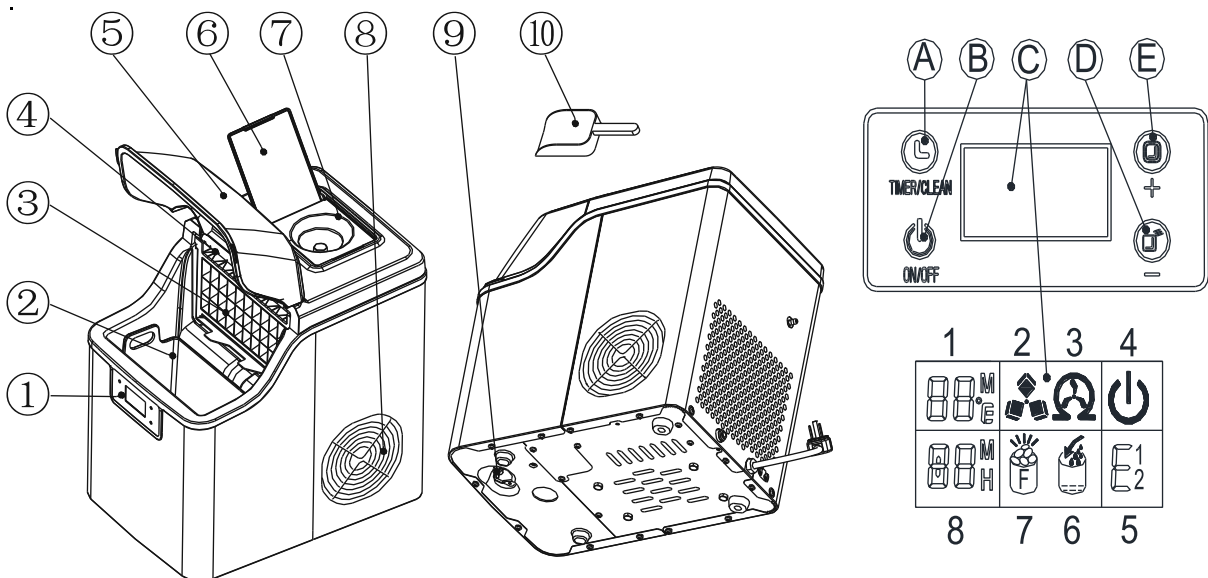

OPERATING PROCEDURES & MAINTENANCE

UNPACKING YOUR ICE MAKER

1. Remove the exterior and interior packaging. Check that ice basket and ice scoop is included. If any parts are missing, please contact our customer service.
2. Clean the interior with lukewarm water and a soft cloth. Take out the ice basket and clean it
3. Find a location for your ice maker that is protected from direct sunlight and other sources of heat (i.e.: stove, furnace, radiator). Place the ice maker on a level surface. Make sure that there is at least 6 inches of space between the back and sides of your ice maker and the wall.
4. Allow one hour for the refrigerant fluid to settle before plugging ice maker in.
5. The appliance must be positioned so that the plug is accessible.

WARNING: fill with potable water only.

CONNECTING YOUR ICE MAKER



DANGER

*** Improper use of the grounded plug can result in the risk of electrical shock. If the power cord is damaged please call our customer service.**

1. This unit should be properly grounded for your safety. The power cord of this appliance is equipped with a three-prong plug which mates with standard three prong wall outlets to minimize the possibility of electric shock.
2. Plug your appliance into an exclusive, properly installed, grounded wall outlet. Do not under any circumstances, cut or remove the third (ground) prong from the power cord. Any questions concerning power and/or grounding should be directed toward a certified electrician.
3. This appliance requires a standard 110-120volt, 60Hz electrical outlet with three-prong ground.

CLEANING AND MAINTAINING YOUR ICE MAKER

Before using your ice maker, it is strongly recommended to clean it thoroughly.

1. Take out the ice basket.
2. Clean the interior with diluted detergent, warm water and a soft cloth.
3. Then use the water to rinse the inside parts, and drain out the water from the draining port by unplugging the Water drainage cap on the bottom.
4. The outside of the ice maker should be cleaned regularly with a mild detergent solution and warm water.
5. Dry the interior and exterior with a soft cloth.
6. When the machine is not in use for a long time, open the water drain cap to drain water completely out from the water reservoir.

After using your ice maker for a long time, we also suggest you should clean your unit. Especially to the water separator pipe and the water filters, you must clean them periodically.

1. If the water separator pipe is blocked and there is no water flowing down when you listen the compressor and the water pump inside are still working, please turn off the unit first and disassemble this pipe down, and clean it. Clean the each hole on the pipe wall displayed in following picture. After cleaning, install back the water separator pipe and be sure the right terminal of the pipe connect to the silicone pipe well and as original.

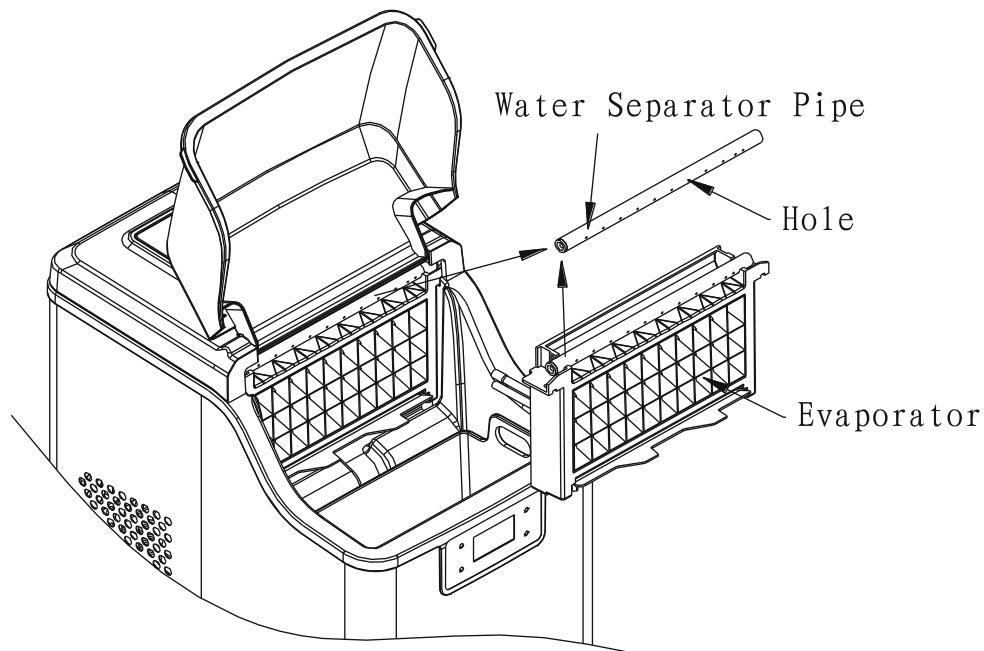

2. For both of the water tank and the big water reservoir, clean them with diluted detergent, warm water and a soft cloth. Then use the water to rinse the inside, and drain out the water from the draining port by unplugging the Water drainage cap on the bottom. It will help you keep the unit and ice-cube hygienicly, and also make the unit work normally.
3. When cleaning, if find that the ice cube left on the evaporator and can not be taken out easily, you can turn on the unit to let the unit enter the ice making process, then press "ON/OFF" button for more than 5 seconds to let the unit start ice harvest process to melt the ice cube. It will help you remove the hard ice cube.

How to drain out the water from the internal tank and big water reservoir completely

Because the water in the big water reservoir is stop to drain port by the water valave, if you want to drain away all the water, please plug on the unit and but don't start the unit, then remove the Water drainage cap at the bottom. Wait some minutes, all of the water will flow out.

USING YOUR ICE MAKER



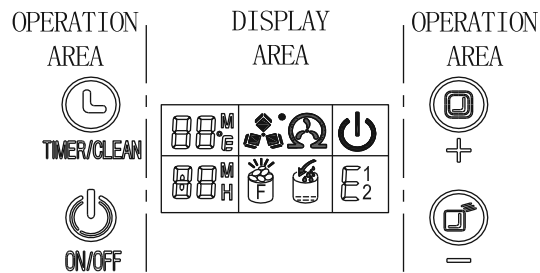

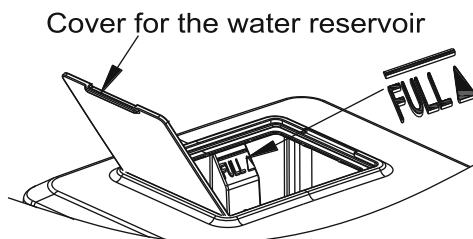

Operation panel and display area



1. Remove the cover of the water reservoir and pour potable water into water reservoir. And be sure to keep water level below the max. level with **FULL** mark displayed in following picture.



Warning: Do not pour the water into the internal water tank located underneath the ice basket. This tank is not big enough and will effect the ice making performance.

2. How to turn on the unit: Plug the unit, electric power symbol <  > will start to flash, and the present ambient temperature will display at top left corner of the displaying window, for example, "80F" letter means the 80 Fahrenheit ambient. Again press the "ON/OFF" button to start the unit, first the water will flow into the water tank to the standard water level, then the compressor start to run to make ice-cube, at same time, power symbol <  > will change to display always and ice-cube symbol <  > will be rotating state, the ambient temperature display will disappear. After some minutes of ice-making duration, the flashing digit will display in the the ambient temperature displaying area, for example, the flashing digit "10M" means that it will take 10 minutes to complete this time ice-making process.
3. When ice maker harvest, symbol <  > flash, the water will flow from top water reservoir to bottom water tank through solenoid valve, the symbol <  > will be on, when the water in the bottom water tank is full, the symbol <  > will be off, then the next ice making cycle start again. When there is no water in the water reservoir, the symbol <  > will keep on. Turn off the unit and fill water again, then restart the unit to make ice cube. Or fill water directly and wait 20mins, the unit will restart.

Remark: The ice making cycle lasts about 13 to 25 minutes, depending on the ambient temperature. And for the first time, according to the initial water temperature, ice-making last time will be a little longer. In the extreme hot room temperature, ice-making time may be Vary a lot, but it will not exceed 35 minutes.

If you think the ice cube is not thick enough, during ice making, press the <+> and <-> to set the ice making lead time. Press one time and the ice making cycle will increase or Reduce one min, 6min most. This can only start from the new cycle.

4. When Ice Full symbol  is on, the unit will stop, take out the ice cube inside, the unit will start working again.

If press the button <ON/OFF> more than 5s, when the ice maker is working, the unit will start harvest. Press button <ON/OFF>, the unit will turn off.

Timer setting. Unit on timer setting, When the unit is working, timer setting the unit off.

Timer setting, When the unit is off, timer the unit on.

Press the <TIMER> button, the display will show <1H>, and then press <+> and <-> to set the time. During the setting, the H is flash, after 5s, the H will keep on and unit will in your Timer setting.

5. Water Drain: take off the Water draining cap the bottom of unit, then drain the water inside. It is better that exchange water every 24 hours and clean unit every 3 days.

Automatic self-cleaning program

Start the self-cleaning program: Plug on the unit, press “TIMER/CLEAN” button on control panel for more than 5 seconds, to enter the self-Cleaning program need 20 minutes. the symbol



rotate on display screens, time count down area display 20M.

Cancel the self-cleaning program: It takes about 20 minutes to complete one self-cleaning program. When the program is over, the system will be in off-state automatically. And also you can press the “ON/OFF” button on control panel to cancel the self-cleaning program by force.

Warning

A、 make sure the water tank ,water filter and the water separator pipe is not blocked, clean them



B、 The water temp will effect the ice making capacity.The lower temp,the more ice cube produce.

C、 The cooler ambient temp, the more ice cube produce.

D、 always use good quality water to make sure the pump work well.Bad quality water will cause pump noise,but doesn' t effect the unit working.

E、 The compressor restart 3mins later if you turn off the unit.

TROUBLESHOOTING

| PROBLEM | POSSIBLE CAUSE | SOLUTION |
|--|--|---|
|  < > is on | Lack of water | Turn off the unit and add water to <FULL>level, then re-start the unit. |
|  >is on | Too much ice cube in the basket | Remove the ice cube in the basket |
| The water reservoir has water,but<  > is on | The inlet solenoid valve breakdown | Need the technical service person to maintain |
| <E1> is on | Ambient temp sensor breakdown | The unit can still work, change a new sensor |
| <E2> is on | Water temp sensor breakdown | The unit can still work, change a new sensor |
| No water in the water Separator pipe | The holes are blocked | Use slim wire to prick each hole, till The water can flow out easily. |
| | Water filter block | Clean the water filter |
| Ice cube thick and can' t Drop down | Ice making cycle too long | Press <->to reduce the ice making time. |
| Ice cube thin | Ambient temp too high | Move the unit to cool place |
| | Water temp too high | The water temp should be no more morethan25°C (77°F) . |
| | Ice making short | Press<+>to increase the ice making Time. |
| Unit work but no ice cube | Ambient temp is high or the Water temp is high | Move the unit to somewhere ambient Temp lower than30°C(86°F),fill cool water. |
| | Refrigerant system leakage | Need the technical service person to maintain |
| | Refrigerant system block | Need the technical service person to maintain |

Thank you for purchasing this product! If you have any questions about the product, such as missing parts, damaged products, product assembling, and operation, please contact us via **Amazon Message** or customer service number: **213-4467172 or 661-4358826**

IMPORTANT

Please call our customer service department for any consulting:

213-4467172

661-4358826

(8:30am - 5:30pm P.S.T.)

DATED PROOF OF PURCHASE IS REQUIRED FOR WARRANTY SERVICE.

AVIS

Veillez appeler le service à la clientèle pour toutes questions au:

213-4467172

661-4358826

(8:30am - 5:30pm P.S.T.)

PREUVE D'ACHAT ORIGINALE REQUISE POUR SERVICE DE GARANTIE.

IMPORTANTE

Sólo hay que llamar nuestro departamento de servicio

al cliente en caso de tener preguntas o inquietudes:

213-4467172

661-4358826

(8:30am - 5:30pm P.S.T.)

SE REQUIERE PRUEBA DE COMPRA CON FECHA PARA SERVICIO BAJO GARANTÍA.

Address : 9733 Topanga Canyon Blvd. APT310, Chatsworth, CA 91311

Phone: 213-4467172 or 661-4358826