

# IMPORTANT INSTRUCTIONS AND OPERATING MANUAL

---

## Electric Fireplace

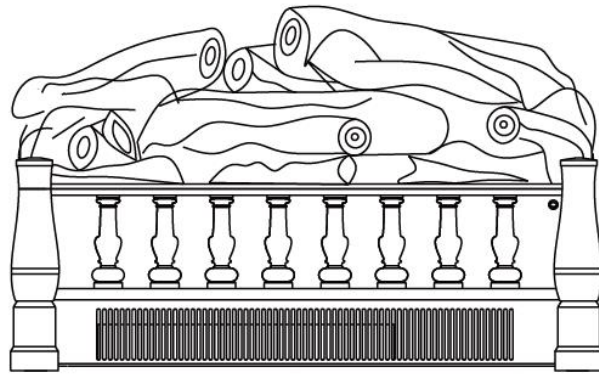

## ZBI-15SRLT/M13

### NO VENTING REQUIRED



#### WARNING

Read and understand this entire owner's manual, including all safety information, before plugging in or using this appliance. Failure to do so could result in fire, electric shock, or serious personal injury.

9733 Topanga Canyon Blvd. APT310, Chatsworth, CA 91311  
Phone: 213-4467172 or 661-4358826

CERTIFIED UNDER CANADIAN AND AMERICAN NATIONAL STANDARDS: ETL





# TABLE OF CONTENTS

<b>IMPORTANT SAFETY INSTRUCTIONS.....</b>	<b>4</b>
<b>1.0 PACKING LIST.....</b>	<b>6</b>
1.1 DIMENSIONS.....	7
<b>2.0 ELECTRICAL INSTALLATION NOTES.....</b>	<b>8</b>
2.1 GENERAL INSTRUCTIONS.....	8
<b>3.0 INSTALLATION INSTRUCTIONS.....</b>	<b>9</b>
3.1 UNPACKING AND TESTING APPLIANCE WALL.....	9
3.2 GROUNDING APPLIANCE.....	9
3.3 ASSEMBLY.....	9
<b>4.0 OPERATING INSTRUCTIONS.....</b>	<b>10</b>
4.1 CONTROL PANEL BUTTONS.....	10
4.2 CONTROL PANEL / REMOTE CONTROL OPERATION.....	10
4.3 REMOTE CONTROL.....	12
<b>5.0 TROUBLESHOOTING GUIDE.....</b>	<b>12</b>
<b>6.0 MAINTENANCE.....</b>	<b>14</b>
6.1 PARTIALLY REFLECTIVE GLASS CLEANING.....	14
6.2 SCHEMATIC DIAGRAM.....	15
<b>7.0 LIMITED WARRANTY.....</b>	<b>15</b>

# IMPORTANT SAFETY INSTRUCTION



## WARNING

These instructions should be carefully retained and read before installation by the user. The booklet must be kept and delivered to the new user in case of disposal of the heater. The manufacturer reserves the right to vary the features of the product without prior notice. The technical data are indicative only.

- 1. THIS APPLIANCE IS HOT WHEN OPERATED AND CAN CAUSE SEVERE BURNS IF TOUCHED.**
- Do not operate the appliance before reading and understanding operating instructions. Failure to operate the appliance according to operating instructions could cause fire or injury.
- Keep combustible materials, such as furniture, pillows, bedding, papers, clothes, and curtains, at least 3 feet (0.9 m) from the front of this appliance and keep away from the sides and the rear. **WARNING:** In order to avoid overheating, do not cover the heater. The clearance may be inadequate when installed in a Recreational Vehicle with the slide-out closed.
- Risk of burns. The appliance should be turned off the power and should be allowed to cool before servicing. To disconnect power to the appliance, turn controls to off, and then remove the plug from the outlet.
- Do not install damaged, incomplete, or substitute components.
- Young children should be carefully supervised when they are in the same room with the appliance. Toddlers, young children, and others may be susceptible to accidental contact burns.
- The remote control contains small batteries. Keep away from children. If swallowed, seek medical attention immediately.
- Ensure you have incorporated adequate safety measures to protect infants/toddlers from touching hot surfaces.
- It is imperative that the control compartments, circulating blower, and its passageway in the appliance are kept clean. The appliance should be inspected before use and annually by a qualified service person.
- Under no circumstances should this appliance be modified.
- Do not use this appliance if any part has been in contact with water. Immediately call a qualified service technician to inspect the appliance and to replace any part of the control system which has been in contact with water.
- Do not operate the appliance with the glass door removed, cracked, or broken. Replacement of the glass should be done by a licensed or qualified service person.
- Do not strike or slam shut the appliance glass door.
- Keep the packaging material out of reach of children and dispose of the material in a safe manner. As with all plastic bags, these are not toys and should be kept away from children and infants.
- Servicing should be done only after the appliance is disconnected from the power supply circuit.
- Always unplug the appliance when not in use.
- Do not operate the appliance if the cord or plug is damaged or after the unit is defective, dropped, or damaged in any manner. Return the appliance to an authorized service facility for examination, electrical or mechanical adjustment, or repair.

- 18.** Do not use the appliance outdoors.
- 19.** Never place the appliance where it may fall into a bathtub or other water container.
- 20.** Do not run cord under carpeting. Do not cover the cord with throw rugs, runners, etc. Arrange the cord away from cluttered areas to avoid a tripping hazard.
- 21.** Connect to properly grounded outlets only.
- 22.** Do not insert or allow foreign objects to enter any ventilation or exhaust opening as this may cause an electric shock or fire or damage the appliance.
- 23.** To prevent a possible fire, do not block air intakes or exhaust in any manner. Do not use the appliance on soft surfaces, like a carpet, where openings may become blocked.
- 24.** Always plug appliances directly into a wall outlet/receptacle. Never use an extension cord or relocatable power tap (outlet/power strip).

**SAVE THESE INSTRUCTIONS**

# 1.0 PACKING LIST

No	Description	Quantity
1	Electric Fireplace	1 pc
2	Installation and Operating instructions	1 pc
3	Remote Control (Battery included)	1 pc

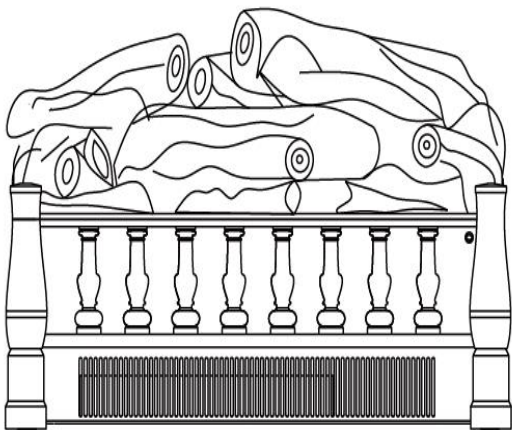

①

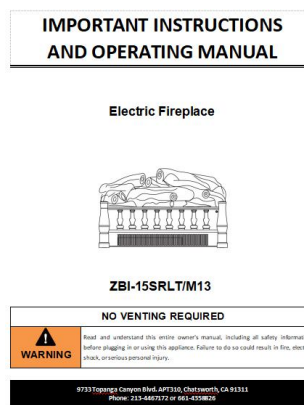

②



③

# 1.1 DIMENSIONS

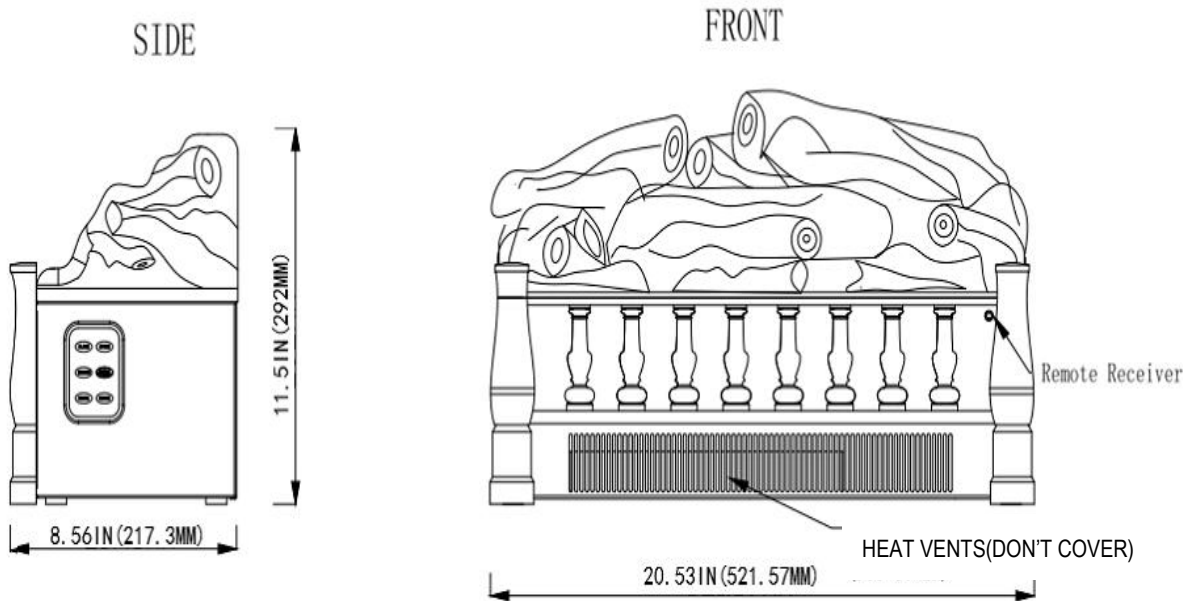

## LISTING APPROVAL

This appliance has been tested in accordance with the ETL Standards for fixed and location dedicated electric room appliances in the United States and Canada. If you need assistance during installation, please contact your local dealer.

**NOTE: This appliance must be electrically wired and grounded in accordance with local, or, in the absence of local, with National Electric Code ANSI/NFPA 70-latest edition in the United States or the Canadian Electric Code and ETL in Canada.**

<b>Model Number</b>	ZBI-15SRLT/M13
<b>Description</b>	Recessed or free-standing appliance
<b>Voltage</b>	120VAC
<b>Watts</b>	Max 1500W
<b>Amps</b>	12.5AMP
<b>BTUs</b>	5100BTU

## 2.0 ELECTRICAL INSTALLATION NOTES

### 2.1 GENERAL INSTRUCTIONS



**CAUTION** - Some parts of this product can become very hot and cause burns. Particular attention has to be given where children and vulnerable people are present.

- A. Prior to plugging your appliance into an electrical outlet, verify that the house circuit breakers for the outlet are on.
- B. The appliance may emit a slight, harmless odor when first used. This odor is normal, and it is caused by the initial heating of internal appliance elements and will not occur again.
- C. If your appliance does not emit heat, consult the operation section of this manual for further information.
- D. Use with an ETL or UL certified surge protector.



**RISK OF FIRE!** THE POWER CORD MUST NOT BE PINCHED AGAINST A SHARP EDGE. SECURE CORD TO AVOID TRIPPING OR SNAGGING TO REDUCE THE RISK OF FIRE, ELECTRIC SHOCK, OR PERSONAL INJURY. DO NOT RUN CORD UNDER CARPETING. DO NOT COVER THE CORD WITH THROW RUGS, RUNNERS, ETC.

ARRANGE THE CORD AWAY FROM CLUTTERED AREAS TO AVOID A TRIPPING HAZARD.

**RISK OF FIRE.** TO PREVENT A POSSIBLE FIRE, DO NOT BLOCK AIR INTAKE OR EXHAUST IN ANY MANNER. DO NOT USE IT ON SOFT SURFACES WHERE OPENINGS MAY BECOME BLOCKED.

**RISK OF FIRE.** DO NOT BLOW OR PLACE INSULATION AGAINST THE APPLIANCE.

THIS ELECTRIC APPLIANCE IS TESTED AND LISTED FOR USE ONLY WITH THE APPROVED OPTIONAL ACCESSORIES. THE USE OF OPTIONAL ACCESSORIES NOT SPECIFICALLY TESTED FOR THIS ELECTRIC APPLIANCE COULD VOID THE WARRANTY AND/OR RESULT IN A SAFETY HAZARD.

IF THE INFORMATION IN THESE INSTRUCTIONS IS NOT FOLLOWED EXACTLY, A FIRE MAY RESULT CAUSING PROPERTY DAMAGE, PERSONAL INJURY, OR DEATH. DO NOT STORE OR USE GASOLINE OR OTHER FLAMMABLE VAPORS IN THE VICINITY OF THIS OR ANY OTHER APPLIANCE.

THIS APPLIANCE IS HEAVY. IT IS HIGHLY RECOMMENDED THAT TWO PEOPLE INSTALL THIS APPLIANCE.

HEATER VENTS ON THE ELECTRIC APPLIANCE CANNOT, IN ANY WAY, BE COVERED. AS IT MAY CREATE A FIRE HAZARD.

#### **Follow all national and local electrical codes.**

1. The heater must not be recessed in the ceiling. There must be enough space around the top of the heater to ensure adequate ventilation.
2. The heater should be at least 2 feet (60 cm) away from any surrounding walls.
3. A distance of at least 3 feet (90 cm) should always be left in front of the heaters to ensure safety.
4. The heater should be mounted at a minimum of 8 inches (20 cm) above ground level.
5. The heater must not be located either directly below or in front of a socket outlet.
6. The heater must be installed so as to prevent anyone who is in the shower or bath from touching any control switches.
7. Make sure that there is no possibility of inflammable material, combustible material, or curtains coming into contact with the heater; there is a risk of fire if this happens.
- 8. DO NOT LEAVE THE HEATER UNATTENDED DURING USE.**



## 3.0 INSTALLATION INSTRUCTIONS

### 3.1 UNPACKING AND TESTING APPLIANCE WALL

Carefully remove the appliance from the box. Prior to installing the appliance, test to make sure the appliance operates properly by plugging the power supply cord into a conveniently located 120 volts grounded outlet.

### 3.2 GROUNDING APPLIANCE

This appliance is for use at 120 volts. The cord has a plug as shown in (A). An adapter as shown in (C) is available for connecting three-blade grounding-type plugs to two-slot receptacles. The green grounding lug extending from the adapter must be connected to a permanent ground, such as a properly grounded outlet box. The adapter should not be used if a three-slot grounded receptacle is available.

To disconnect the appliance, turn controls to off, and then remove the plug from the outlet.

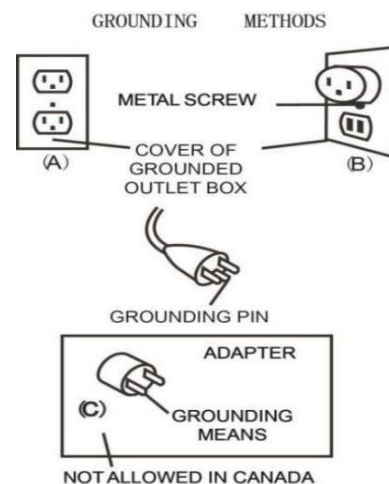

## 3.3 ASSEMBLY



**ALWAYS unplug** this fireplace heater **before assembly, cleaning, or relocating.**

Failure to do so could result in **electric shock, fire, or personal injury.**

**KEEP drapery and other furnishings** at least **3ft /0.9m** from the **front and sides** of the electric fireplace.

**AFTER installation,** ensure that there is **≥0.004 m<sup>2</sup> ventilation area** between the **inside and outside** of the fireplace mantel.

Your new electric fireplace may be installed virtually anywhere in your home. However, when choosing a location, ensure that the general instructions are followed. Power supply service must be either completed or placed within the electric fireplace prior to finishing to avoid reconstruction.

## 4.0 OPERATING INSTRUCTIONS

Once the appliance has been plugged into a grounded electrical outlet, it is ready to operate.

### 4.1 CONTROL PANEL BUTTONS

The control panel buttons are located on the right of the fireplace as illustrated. Press the indicator to turn on the appliance, and press the other side to turn it off.

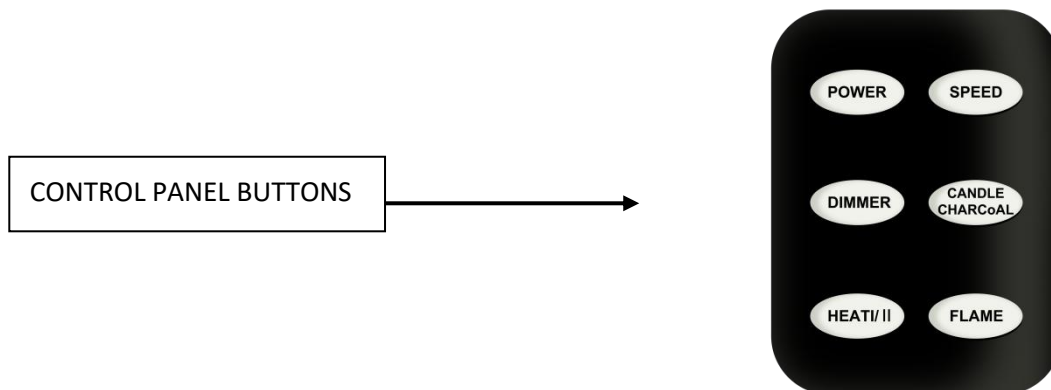

### 4.2 CONTROL PANEL / REMOTE CONTROL OPERATION

The control panel is shown on the upper right of the appliance.

◆ Move the battery's transparent insulating piece away before using the remote control.

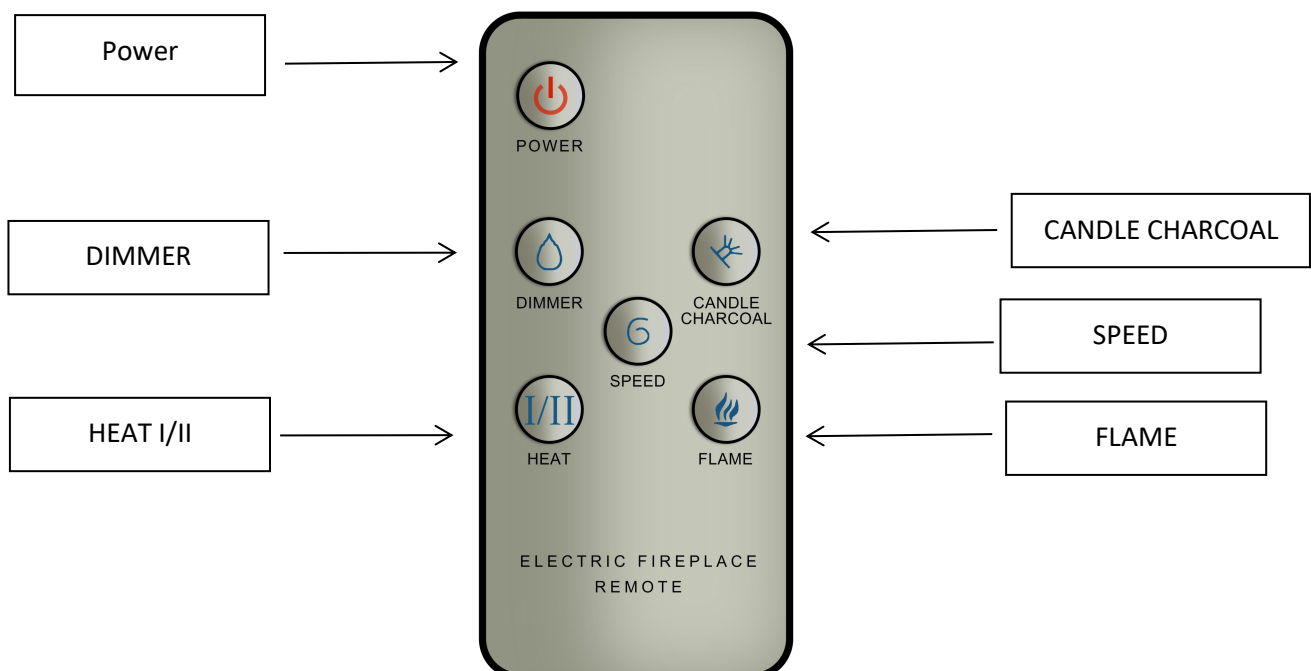

<b>POWER</b>	To activate or deactivate all the functions including all lighting types and heating modes.
<b>FLAME</b>	To activate or deactivate the flame.
<b>DIMMER</b>	To adjust the brightness of flame (5 different light variants adjustable)
<b>CANDLE /CHARCOAL</b>	When the HEAT is on, the CANDLE/CHARCOAL light illuminates constantly and cannot be turned off. When the POWER is on and the HEAT is off, the CANDLE/CHARCOAL can be turned off.  Note:Through the button can adjust the light flashing mode.When the power is on the light is steady, when press button one time the light flashing.
<b>HEAT I/II</b>	Press the HEAT button one time to enable the fireplace to operate at 750 watts. Press it the second time to enable the fireplace to operate at 1, 500 watts. Press it the third time to shut down the fireplace.
<b>FLAME SPEED</b>	Control Flame speed 5 Settings:(L1-L2-L3-L4-L5) flame speed from L1 to L5 L5 is the fastest setting.

**NOTICE:** When the heater is first turned on, a slight odor may be present. This is normal and should not occur again unless the heater is not used for a long period of time.

**NOTICE:** To improve operation, aim the remote control at the front of the fireplace. **DO NOT** press the buttons too quickly. Give the unit enough time to respond to each command.



**TIP**

**Please put the heater 2.9 inches--4.5 inches (75mm--115mm) away from the wall for a more realistic flame effect.**

## 4.3 REMOTE CONTROL

◆ Move the battery's transparent insulating piece away before using.



Battery must be recycled or disposed of properly. Check with your Local Authority or Retailer for recycling advice in your area.

## 5.0 TROUBLESHOOTING GUIDE

PROBLEM		SOLUTION
<b>Heater doesn't turn on with the power switch.</b>	1. The POWER button on the remote is off.	Turn on the POWER button on the remote.
	2. Circuit breaker has tripped.	Too many appliances are on this circuit. Be sure that the electrical supply for this unit is an individual circuit.
	3. Heater is unplugged from wall outlet.	Make sure the power cord is plugged into a functioning and properly grounded 15 Amp 120V AC electrical outlet.
	4. Power cord or power plug is damaged.	Contact a qualified electrician to replace the power cord.
	5. Power outlet for power plug prong is loose.	Check the power outlet and replace it with a new one.
	6. Loose wiring.	Check all wiring for loose connections. Contact a qualified electrician.

<b>Heater is on, but no flame or low flame intensity.</b>	1. Heater switches are on, but Flame power switch is not on.	Turn on the flame power switch.
	2. Flame Adjusting knob is at low setting.	Turn the knob to the maximum setting.
	3. Loose wiring.	Check all wiring for loose connections. Contact a qualified electrician.
<b>There is no flame.</b>	1. Flame element is not attached to the motor.	Contact us via <b>Amazon Message</b> or call customer service number: <b>213-4467172 or 661-4358826.</b>
	2. Rotation motor is defective.	Contact us via <b>Amazon Message</b> or call customer service number: <b>213-4467172 or 661-4358826.</b>
<b>Excessive noise in the lower portion of the heater.</b>	1. Flame element isn't seated properly	Contact us via <b>Amazon Message</b> or call customer service number: <b>213-4467172 or 661-4358826.</b>
	2. Motor is defective.	Contact us via <b>Amazon Message</b> or call customer service number: <b>213-4467172 or 661-4358826.</b>
<b>Heater system doesn't function.</b>	1. Heater buttons are off.	Turn the heater power switch to the "ON" position.
	2. Heater system is overheated.	Maybe the heater is covered, or the air inlet or outlet is blocked; remove the clothes or the blockage and turn off the remote's power switch and unplug it. Wait for 10 minutes, and then turn the heater on again.
	3. Loose wiring.	Check all wiring for loose connections. Contact a qualified electrician.
	4. The air inlet or air outlet is blocked completely.	Leave adequate space around the unit. Remove the blockage that is left on or in front of the air outlet.
<b>"HEATER" button has been turned on, but there is no airflow.</b>	1. The heater system is overheated. Temperature Limit thermostat is switched off.	Check the air inlet and outlet. Turn off the remote's power switch and unplug it. Wait for 10 minutes, and then turn the heater on again.
	2. Fan motor is defective.	Contact us via <b>Amazon Message</b> or call customer service number: <b>213-4467172 or 661-4358826.</b>
	3. Fan blower is broken.	Contact us via <b>Amazon Message</b> or call customer service number: <b>213-4467172 or 661-4358826.</b>
	4. The "POWER" and the "HEATER" switches are not turned on.	Turn these two switches on.
<b>Fan runs, but no heat is coming out.</b>	1. Loose wiring.	Contact us via <b>Amazon Message</b> or call customer service number: <b>213-4467172 or 661-4358826.</b>
	2. Bad heating element.	Contact us via <b>Amazon Message</b> or call customer service number: <b>213-4467172 or 661-4358826.</b>
	3. Built-up dirt on the fans.	Clean all fans.
	4. Heater fan is defective.	Contact us via <b>Amazon Message</b> or call customer service number: <b>213-4467172 or 661-4358826.</b>

<b>The remote control does not work.</b>	1. The battery is not properly installed.	Make sure the battery is properly installed. Move the battery's transparent insulating piece away before using.
	2. Not pointing to the right position.	Aim the remote control at the receiver (middle of the fireplace).
	3. There is an obstacle in front of the machine.	Remove the objects that may be in the way. Items between the remote control and the remote-control receiver can block the signal.
	4. Press the remote-control buttons too quickly.	Don't press the remote-control buttons too quickly. Give the unit enough time to respond to your commands.
<b>There is an odor coming from the heater.</b>	The heater may emit a slight, harmless odor when first used. This is a normal condition caused by the initial heating of the internal parts and will not occur again.	

**NOTE: For most functional problems, you can unplug the unit, wait for 10 minutes, and plug it again; the machine will reset to the initial status (default settings).**

**If the problem is still not solved, please contact us via Amazon Message or call customer service number:213-4467172 or 661-4358826.**

## 6.0 MAINTENANCE



DISCONNECT POWER AND ALLOW THE HEATER TO COOL BEFORE ATTEMPTING ANY MAINTENANCE OR CLEANING TO REDUCE THE RISK OF FIRE, ELECTRIC SHOCK, OR DAMAGE TO PEOPLE.

THE FIREPLACE SHOULD NOT BE OPERATED WITH AN ACCUMULATION OF DUST OR DIRT ON OR IN THE UNIT, AS THIS CAN CAUSE A BUILD-UP OF HEAT AND POTENTIAL DAMAGE. FOR THIS REASON, THE HEATER MUST BE INSPECTED REGULARLY, DEPENDING ON CONDITIONS AND AT LEAST AT YEARLY INTERVALS.

## 6.1 PARTIALLY REFLECTIVE GLASS CLEANING

The partially reflective glass is cleaned in the factory during the assembly operation. During shipment, installation, handling, etc., the partially reflective glass may collect dust particles; these can be removed by dusting lightly with a clean, dry cloth.

The partially reflective glass can be cleaned with a damp cloth to remove fingerprints or other marks. The partially reflective glass should be completely dried with a lint-free cloth to prevent water spots. To prevent scratching, do not use abrasive cleaners.

## 6.2 SCHEMATIC DIAGRAM

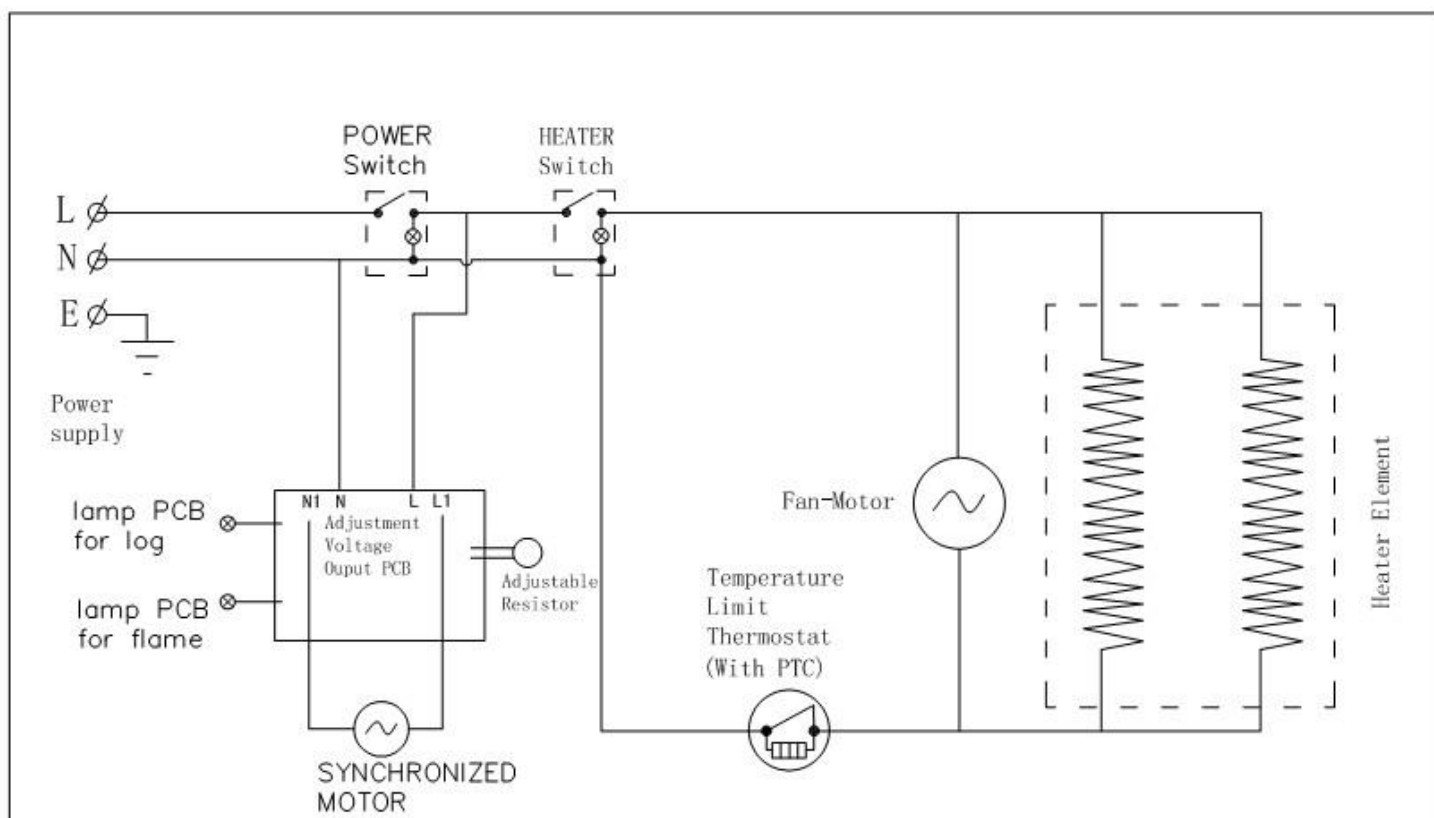

## 7.0 LIMITED WARRANTY

This warrants to the original purchaser that this product is free from defects in material and workmanship as of the date of purchase and that it will, under normal use and proper care, remain so for one year from the date of purchase. Missing or initially defective parts will be replaced free of charge during the period of this limited warranty. If parts are unavailable, a comparable replacement or refund will be given. **The original dated sales receipt is required for all warranty claims.** This warranty does not cover damage that has occurred during transport from the point of purchase to the consumer's home. This warranty does not cover glass, light bulbs, batteries, transportation, labor, or other issues not associated with the manufacture of the product.

**This product is for residential use only. Any and all commercial use of this product voids all warranties and frees the manufacturer from all liability.**

Read and understand all assembly and operating instructions, all safety information, and warnings before use. The following will void this warranty: Damage caused from tampering with, modifying, or altering the fireplace insert in any manner; Damage due to incorrect assembly, improper care, misuse, or abuse; Damage from being used with the wrong power source; Water damage; Damage caused from this insert being used outdoors; Damage caused from this insert being used for excessive periods of time; Damage caused by the insert being used in a commercial application; Damage from use as a primary heat source; Other misuse or abuse not specifically listed herein.

**This product is not intended to be used as a primary heat source. It is for supplemental heating purposes only.**