

Portable Air Conditioner Owner's Manual

Original instructions

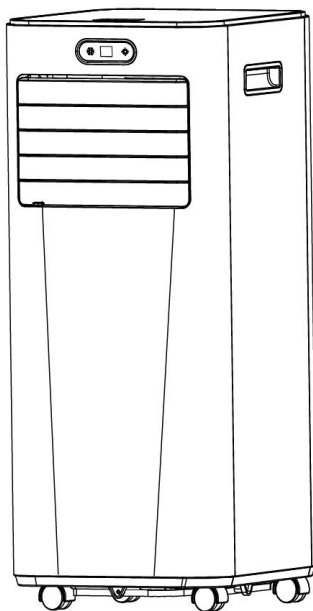

Item NO: A4210L-8K/10K

Applicable model: OL-A010L-05CD/06CD

READ AND SAVE THESE INSTRUCTIONS

CONTENTS

1. BEFORE YOU BEGIN
2. FOR YOUR SAFETY
3. PRODUCT OVERVIEW
4. INSTALLATION
5. OPERATION
6. CLEANING AND CARE
7. TROUBLESHOOTING
8. DECOMMISSIONING

1. BEFORE YOU BEGIN

1.1 PRODUCT DESCRIPTION

Our powerful portable air conditioner provides great cooling solutions for single rooms, creating a comfortable atmosphere in your space. It also has ventilation and dehumidifying function to circulate air and remove moisture. It is designed with a self-contained system that does not require any permanent installation, allowing you to move it to wherever it is most needed. It is commonly used in kitchens, temporary residences, computer rooms, garages, and many other places where the installation of Air-conditioner Outdoor Unit is limited.

2. FOR YOUR SAFETY

Your safety is the most important thing we concern!



WARNING

Please read this manual carefully and fully understand before operating your appliance.

Your safety is the most important thing we concern!



WARNING

Please read this manual carefully and fully understand before operating your appliance.

2.1 OPERATIONAL PRECAUTIONS

WARNING-To reduce the risk of fire, electric shock or injury to persons or property:

- Please let the portable air conditioner stand upright for at least 24 hours before plugging in.
- If the supply cord is damaged, it must be replaced by the manufacturer, its service agent or similarly qualified persons in order to avoid a hazard.
- The appliance shall be disconnected from its power source during service.
- Always operate the unit from a power source of equal voltage, frequency and rating as indicated on the product identification plate.
- Always use a power outlet that is grounded.
- Unplug the power cord when cleaning or when not in use.
- Do not operate with wet hands. Prevent water from spilling onto the unit.
- Do not immerse or expose the unit to rain, moisture or any other liquid.
- Do not leave the unit running unattended. Do not tilt or turn over the unit.
- Do not unplug while the unit is operating.

- Do not unplug by pulling the power cord.
- Do not use an extension cord or an adapter plug.
- Do not put objects on the unit.
- Do not climb or sit on the unit.
- Do not insert fingers or other objects into the air outlet.
- Do not touch the air inlet or the aluminum fins of the unit.
- Do not operate the unit if it is dropped, damaged or it shows signs of product malfunction.
- Do not clean the appliance with any chemicals.
- Ensure the unit is far away from fire, inflammable, or explosive objects.
- The unit shall be installed in accordance with national wiring regulations.
- Do not use means to accelerate the defrosting process or to clean, other than those recommended by the manufacture.
- The appliance shall be stored in a room without continuous operation of combustion sources (for example, open flames, an operating gas appliance or an operating electric heater).
- The appliance shall be stored so as to prevent mechanical damage from occurring.
- Do not piece or burn, even after use.
- Be aware that refrigerants may not contain an odour.
- Compliance with national gas regulations shall be observed.
- Keep any required ventilation openings clear of obstruction.
- The appliance shall be stored in a well-ventilated area where the room size corresponds to the room area as specified for operation.

If there is anything you don't understand or you need help, please contact the dealer services.

3. PRODUCT OVERVIEW

3.1 PRODUCT DIAGRAM

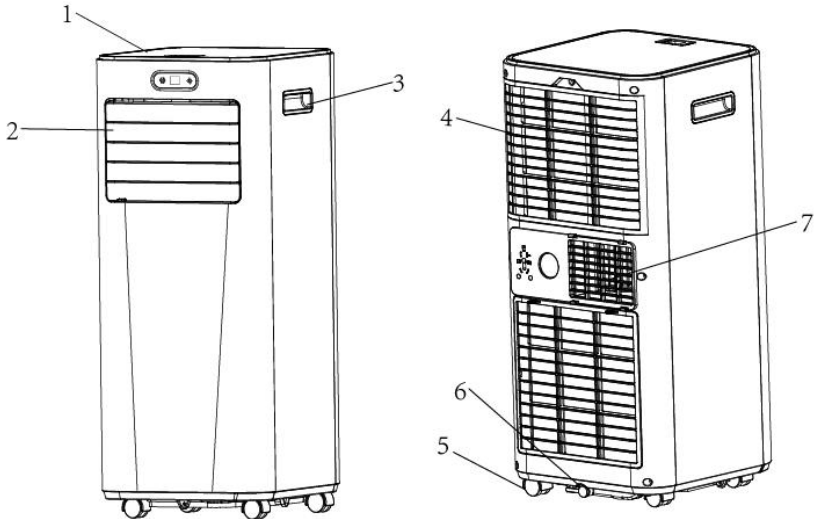

1	Control panel	4	Air inlet with air filter	7	Air exhaust
2	Air outlet with adjustable louver	5	Caster		
3	Handle	6	Drainage hole		

Note: The appearance is only for reference. Please see the real product for detailed information.

3.2 FEATURES

- ✓ High capacity in a compact size with fan, cooling and dehumidifying function.
- ✓ Temperature setting and display
- ✓ LED digital display
- ✓ Electronic control with built-in timer and sleep mode
- ✓ Self-evaporating system for better efficiency
- ✓ Auto shut-off upon tank-full
- ✓ Auto re-start in the event of power outage
- ✓ Auto defrosting function at low ambient temperatures
- ✓ Remote control
- ✓ 2-speed fan
- ✓ Casters for easy mobility

4. INSTALLATION

4.1 UNPACKING

- Unpack the carton and take the appliance and accessories out.
- Check the device after unpacking for any damage or scratches on it.
- Accessories:
 - 1. Exhaust hose
 - 2. Hose connector
 - 3. Window kit adapter
 - 4. Remote control

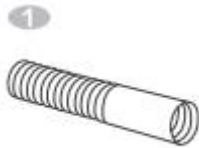

- 5. Window kit



- 6. Water pipe
- 7. User manual

4.2 Choose your location

- If it is tipped more than 45°, allow the unit to set upright for at least 24 hours before starting up.
- Place the unit on a firm and level surface in an area with at least 19 inches of free space around it to allow for proper air circulation.
- Do not operate in close proximity to walls, curtains, or other objects that may block air inlet and outlet. Keep the air inlet and outlet free of obstacles.
- **Never** install the unit where it could be subject to:
 - Heat sources such as radiators, heat registers, stoves or other products that produce heat;
 - Direct sunlight;
 - Mechanical vibration or shock;
 - Excessive dust;
 - Lack of ventilation, such as cabinets or bookcases;
 - Uneven surface.

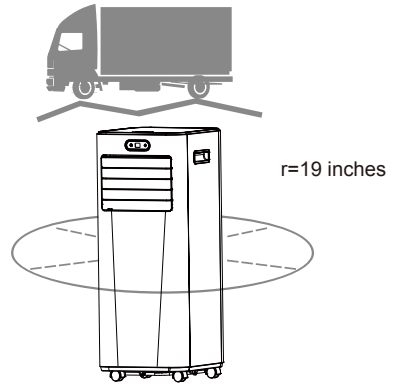

4.3 ATTACH THE EXHAUST HOSE

The air conditioner requires being vented outside so that the exhaust air which comes from the appliance and contains waste heat and moisture can escape the room.

Do not replace or extend the exhaust hose. It will result in decreasing efficiency, or even worse, shut down the unit due to low back pressure.

Step 1: Connect the hose connector to one end of the exhaust hose.

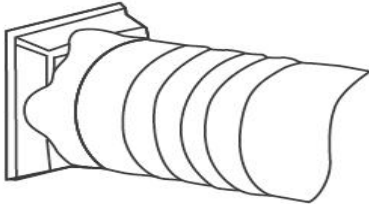

Step 2: Connect the windows kit adapter to the other end of the exhaust hose.

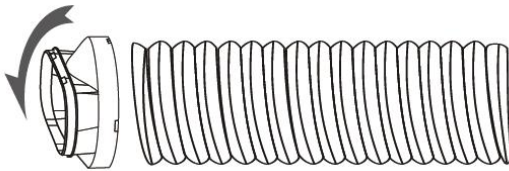

Step 3: Extend the adjustable window kit to the length of your window. Connect the exhaust hose to the window kit.



Step 4: Close your window to secure the kit in place. It's needed to hold the window kit firmly in place. Secure the window kit with duct tape if required. It is recommended that the gap between the adapter and the sides of the window should be sealed off for maximum efficiency.

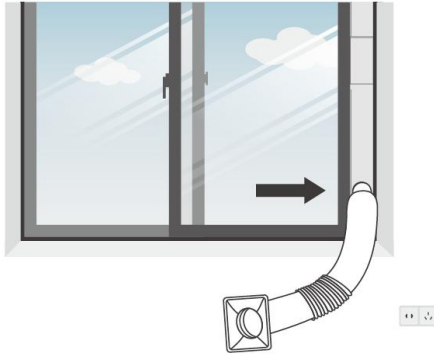

Step 5: Attach the hose connector to the exhaust air outlet of unit.

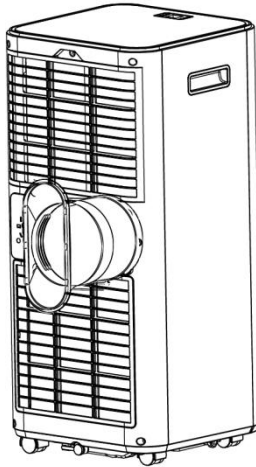

Step 6: Adjust the length of the flexible exhaust hose, and avoid bends in the hose. Then place AC near an electrical outlet.

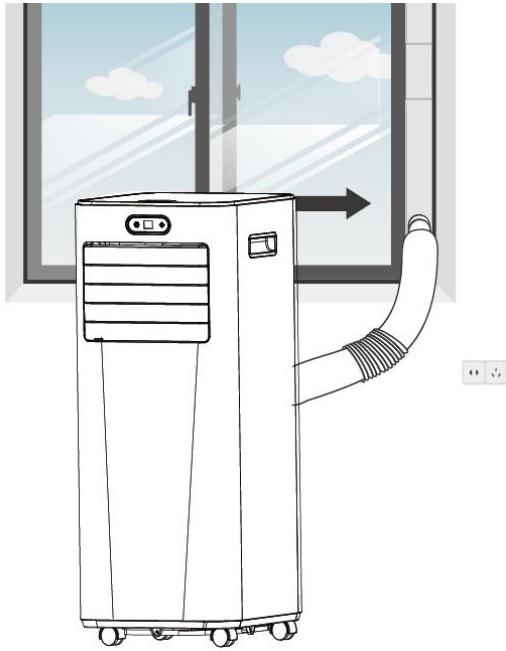

Step 7: Adjust the louver at the air outlet, and then switch on the unit.

5.1 CONTROL PANEL AND DISPLAY

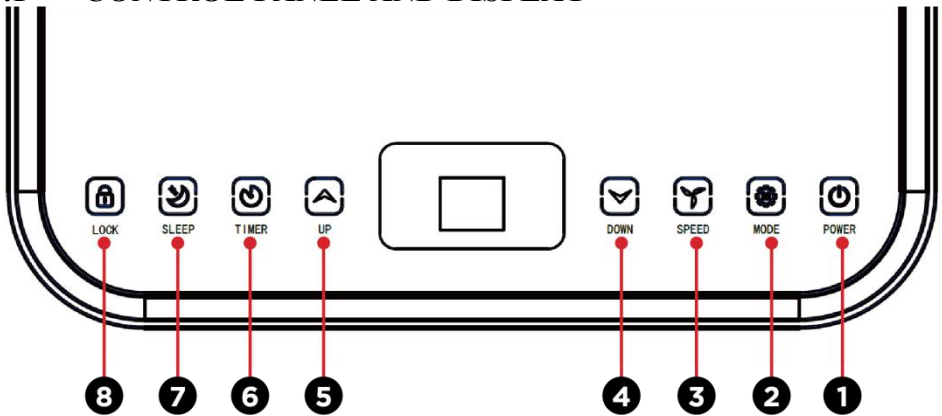

1	POWER	Press to switch the machine on or off.
2	MODE	Press to switch the operation mode among fan, cooling, and dehumidify.
3	SPEED	Press to switch the fan speed between HIGH and LOW.
4	DOWN	Decrease the desired temperature or timer setting.
5	UP	Increase the desired temperature (61°F–90°F) or timer setting.
6	TIMER	Set time for the unit to automatically start or stop.
7	SLEEP	Press to turn on/off sleep mode.
8	LOCK	Long press to turn on/off the child lock function.
10	MODE Indicator	Display the mode among cooling, dehumidify and fan.

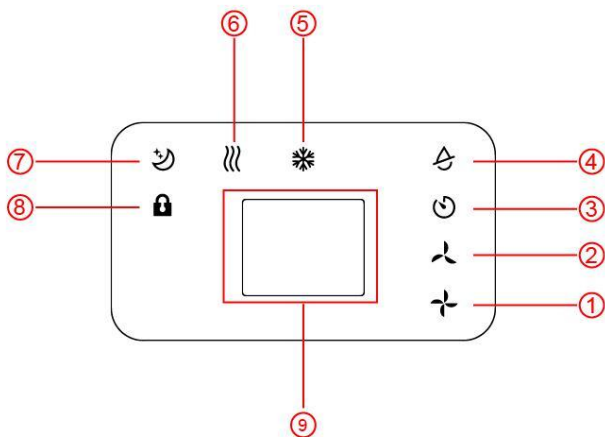

- | | | |
|--------------------|------------------|-------------------|
| 1. High Fan Speed | 2. Low Fan Speed | 3. Timer |
| 4. Dehumidify Mode | 5. Cooling Mode | 6. Fan Mode |
| 7. Sleep | 8. Lock | 9. Display Window |

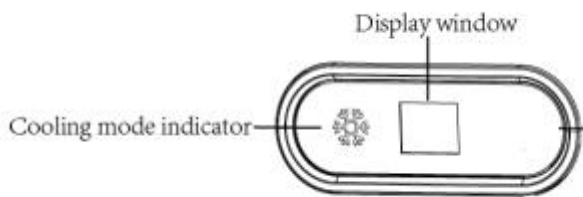

5.2 REMOTE CONTROL

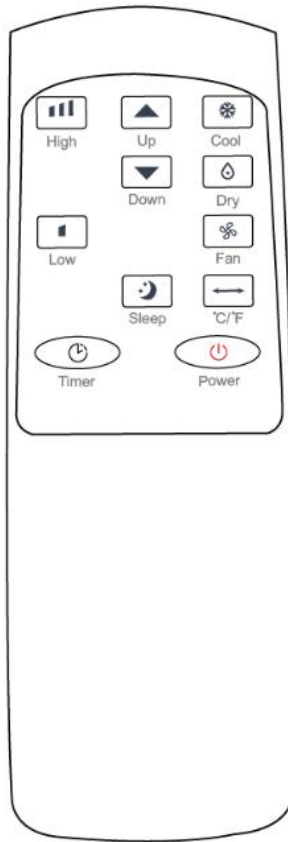

5.3 SETTINGS

5.3.1 Start-up and Shut-down

- ⇒ Press POWER to turn on the unit.
- ⇒ Press MODE button to select the desired operation mode.
- ⇒ Press POWER again to turn off the power.

5.3.2 Operation mode

The unit has four operation modes: cool, dry, fan and sleep.

A. Cooling your room

Select the cool mode to lower the temperature in your room.

- ⇒ Press MODE button repeatedly until the COOL indicator lights up.
- ⇒ Press Up/Down button to adjust the temperature which is displayed on the screen.
The temperature can be set between 61°F and 90°F.
- ⇒ Press SPEED button repeatedly until the desired fan speed indicator lights up.
To control the direction of the air flow horizontally, please adjust the inner louver by hand.

Note: The air conditioner stops if the room temperature is lower than the selected temperature.

B. Ventilating your room

- ⇒ Press MODE button repeatedly until the FAN indicator lights up.
In ventilation mode, the room air is circulated, but not cooled.
- ⇒ Press SPEED button repeatedly to select the fan speed as desired.

C. Drying your room

⇒ Press MODE button on the control panel or remote control, the dry indicator lights up. The fan speed is unable to be selected. User should connect the hose to the drain outlet at the bottom of the unit.

Note: In this mode, the fan speed switches over to low speed and cannot be selected.

D. Sleep mode

The sleep mode can be activated when in cool mode.

■ In cool mode:

After 1 hour the sleep mode is turned on, the preset temperature will automatically increase by 34°F ; after another hour, the preset temperature will again increase by 34°F .

5.3.3 TIMER SETTING (1 hour–24 hours) :

The timer has two ways of operation:

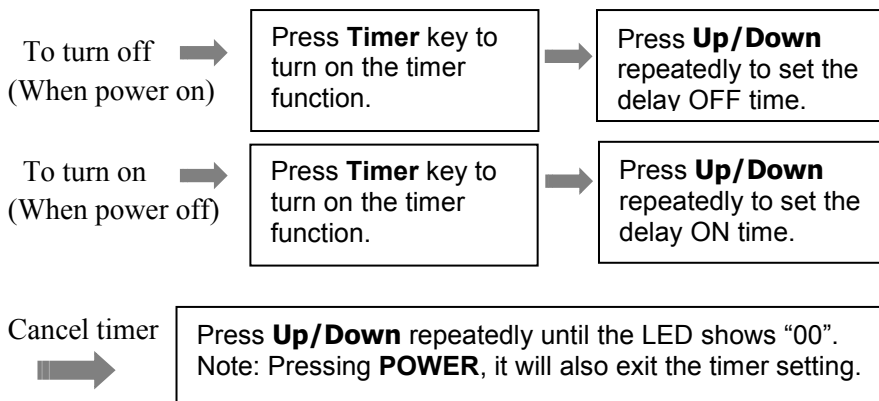

5.3.4 Automatic Defrosting

At low room temperatures, frost may build up at the evaporator during the operation. The unit will automatically start defrosting and the **POWER** LED will blink. The defrosting control sequence is as follows:

- A. When the unit operates in cooling operation and drying operation, and the ambient temperature sensor senses that the evaporator coil temperature is below 30°F, the unit will restart to cooling operation mode after the compressor stops operating for 10 minutes or the coil temperature rises up to 44°F.
- B. When the unit operates in the drying operation, once the coil temperature sensor senses that the temperature of the evaporator is below 104°F, and the differential temperature between the coil temperature and the room temperature is below 66°F, the unit will start defrosting for 5 minutes and the power indicator will blink after the compressor runs for 20 minutes.

5.3.5 Overload Protection

In the event of a power loss, there is a 3-minute delay to protect the compressor before it restarts.

5.4 DRAINAGE

Manual drainage:

1) When the machine stops after the water is full, please unplug the power plug.

Note: Please move the machine carefully so as not to spill the water in the water pan at the bottom of the body.

2) Place the water container below the side water outlet behind the body.

3) Unplug the water plug, the water will automatically flow into the water container.

Note:

1. Collect the water plug properly.

2. During drainage, the body can be tilted slightly backwards.

3. If the water container cannot hold all the water, before the water container is full, install the water outlet with the water plug as soon as possible to prevent water from flowing to the floor or the carpet.

4) When the water is discharged, reinstall the water plug.

Note: Restart the machine after the water plug and the drainage cover are installed; otherwise, condensed water of the machine will flow to the floor or the carpet.

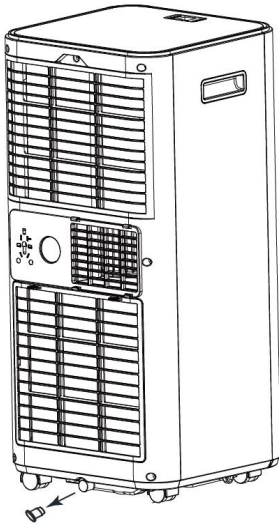

Continuous drainage

The self-evaporating system uses the collected water to cool the condenser

coils for a more efficient performance. Except in drying operation and high humidity conditions, there is no need to empty the drainage tank in cooling operation. The condensed water evaporates at the condenser and evacuates through the exhaust hose.

For continuous operation or unattended operating in drying operation, please connect the attached drain hose to the unit. Condensed water can automatically flow into a bucket or be drained by gravity.

- Switch off the unit before operating.
- Remove the plug of the water outlet opening, and keep it in a safe area.
- Securely and properly connect the drain hose and make sure it is not kinked and clear of obstruction.
- Place the outlet of hose over a drain or bucket and ensure that water could freely flow out of the unit.
- Do not submerge the end of the hose into water; otherwise, it can cause "Air Lock" in the hose.

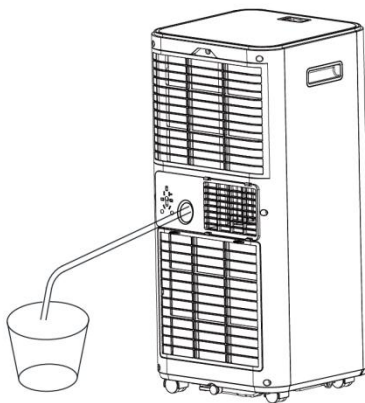

To avoid water spillage:

- As the negative pressure of condensed drain pan is large, tilt the drain hose downward toward the floor. It is appropriate that the degree of the inclination should exceed 20 degrees.
- Straighten the hose to avoid condensed water remaining in the hose.

6. CLEANING AND CARE

6.1 CLEANING THE AIR FILTER (every two weeks)

Dust collects on the filter and restricts the airflow. The restricted airflow reduces the efficiency of the system and if it becomes blocked, damage to the unit may occur.

The air filter requires regular cleaning. The air filter is removable for easy cleaning. Do not operate the unit without an air filter, or the evaporator may be contaminated.

1. Press POWER button to switch off the unit and unplug the power cord.
2. Remove the filter mesh from the unit.
3. Use a vacuum cleaner to suck dust from the filter.
4. Turn the filter over and rinse the air filter under running water. Let the water run through the filter in the opposite direction of air flow. Set aside and allow the filter to air dry completely before reinstalling.

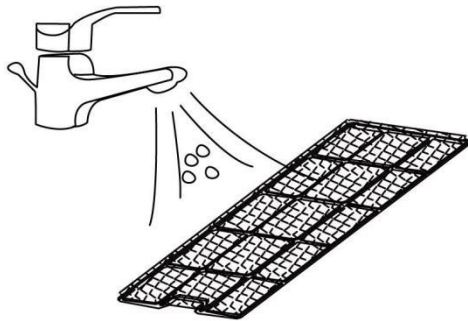

Switch off the unit and remove the air filters.

Rinse the air filters under running water.

Warning!!!

Do not touch the evaporator surface with bare-hand; otherwise, it could cause injury to your fingers.

6.2 CLEANING UP OF REFRIGERANT

General Measures:

1. Gas/vapor that is heavier than air may accumulate in confined spaces, particularly at or below ground level.
2. Eliminate every possible source of ignition.
3. Use appropriate personal protection equipment (PPE).
4. Evacuate unnecessary personnel.
5. Do not get the refrigerant in eyes, on skin, or on clothing. Do not breathe in vapors or gas.
6. Prevent entry to sewers and public waters.
7. Stop the source of the refrigerant from releasing, if safe to do so. Consider the use of water spray to disperse vapors.
8. Isolate the area until gas has been dispersed. Ventilate and gas test the area before entering. Contact competent authorities after a spill.

7. TROUBLESHOOTING

Symptom		Inspection	Solution
The unit is not operating.		✓ Check the power connection securely.	➤ Insert the power cord securely into the wall outlet.
		✓ Check if the water level indicator lights up.	➤ Empty the drain pan by removing the rubber plug.
		✓ Check the room temperature.	➤ The range of the operating temperature is 41°F–95°F.
The unit works with reduced capacity.		✓ Check the air filter for dirt.	➤ Clean the air filter as necessary.
		✓ Check if the air duct is blocked.	➤ Clear the obstacle.
		✓ Check if the room door or window is open.	➤ Keep the door and windows closed.
		✓ Check if the desired operating mode is selected and the temperature is properly set.	➤ Set the mode and temperature at proper set-point according the manual.
		✓ The exhaust hose is detached.	➤ Make sure the exhaust hose is securely attached.
Water Leakage		✓ Overflow while moving the unit.	➤ Empty the water tank before transport.
		✓ Check if the drain hose is kinked or bent.	➤ Straighten the hose.
Excessive Noise		✓ Check if the unit is securely positioned.	➤ Place the unit on horizontal and firm ground.
		✓ Check if there are any loose or vibrating parts.	➤ Secure and tighten the parts.
		✓ Noisy sounds like water flowing.	➤ Noise comes from flowing refrigerant. This is normal.
Error Codes	E0	✓ Communication faults between main PCB and display PCB.	➤ Check the wire harness of the display PCB for damage.
	E1	✓ Ambient temperature sensor failure.	➤ Check connection or replace it. Clean or replace the temperature sensor.
	E2	✓ Coil temperature sensor failure.	➤ Check connection or replace it. Clean or replace the temperature sensor.
	Ft	✓ High level alarm of condensed water.	➤ Empty the drain pan by removing the rubber plug.

8.1 STORAGE

Long-term Storage—If you will not use the unit for an extended period of time (more than a few weeks), it is best to clean the unit and dry it out completely. Please store the unit with the following steps:

1. Unplug the unit and store the exhaust hose with the window kit.
2. Drain the remaining water from the unit.
3. Clean the filter and let the filter dry completely in a shaded area.
4. Reinstall the filter at its original position.
5. The unit must be kept in upright position when in storage.
6. Preserve the machine indoor in a dry and safe place with good ventilation and without corrosive gas.

ATTENTION:

The evaporator inside the machine has to be dried out before the unit is packed to avoid component damage and molds. Unplug the unit and place it in a dry open area for days to dry it out. Another way to dry the unit is to turn on the machine, adjust it to low-wind ventilation mode, and maintain this state until the drainage pipe becomes dry, so as to keep the inside of the body in a dry state and prevent it from mildewing.

8.2 DISPOSAL



WARNING!!!

Releasing refrigerant into atmosphere is strictly forbidden!

Do not dispose of electrical appliances as unsorted municipal waste. Use separate collection facilities. Contact your local government for information regarding the collection systems available. If electrical appliances are disposed of in landfills or dumps, hazardous substances can leak into the groundwater and get into the food chain, damaging your health and well-being.



Thank you for purchasing this product! If you have any questions about the product, such as missing parts, damaged products, product assembling, and operation, please contact us via **Amazon Message** or customer service number: **213-4467172 or 661-4358826**

IMPORTANT

Please call our customer service department for any consulting:

213-4467172

661-4358826

(8:30am - 5:30pm P.S.T.)

DATED PROOF OF PURCHASE IS REQUIRED FOR WARRANTY SERVICE.

AVIS

Veillez appeler le service à la clientèle pour toutes questions au:

213-4467172

661-4358826

(8:30am - 5:30pm P.S.T.)

PREUVE D'ACHAT ORIGINALE REQUISE POUR SERVICE DE GARANTIE.

IMPORTANTE

Sólo hay que llamar nuestro departamento de servicio al cliente en caso de tener preguntas o inquietudes:

213-4467172

661-4358826

(8:30am - 5:30pm P.S.T.)

SE REQUIERE PRUEBA DE COMPRA CON FECHA PARA SERVICIO BAJO GARANTÍA.

Address : 9733 Topanga Canyon Blvd. APT310, Chatsworth, CA 91311

Phone: 213-4467172 or 661-4358826

