

Instruction Manual

Remote Tower Fan

Model NO.: 5304

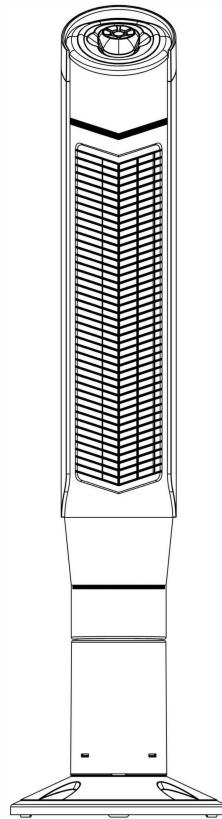

Please read this manual carefully before operating this product
Keep this manual for further reference.

Part 1 IMPORTANT SAFEGUARDS

When using an electrical appliance, basic safety precautions should always be observed, including the following:

READ ALL INSTRUCTIONS BEFORE USING

WARNING: To reduce the risk of fire, electric shock, or injury to person:

1. This fan is for household use only.
2. Before using for the first time, please check that your voltage is in accordance with the product's nameplate requirements.
3. Please check status of the power cord and plug before use for safety.
4. Always turn the fan OFF and unplug it from the electric outlet when it is not in use.
5. Caution is necessary when the appliance is used near children.
6. Do not run the power cord under carpets and do not cover the cord with throw rugs. Do not put cord under furniture or appliances. Arrange cord away from traffic areas so that people will not be tripped over by it.
7. Do not operate any fan with the damaged cord or plug. Discard the fan or return it to an authorized service facility for examination and repair.
8. If the fan's power supply cord is damaged, it must be replaced by the manufacturer or its service agent to avoid a safety hazard.
9. Use the fan in a well-ventilated area. Place the fan at least 8 inches from any walls to ensure the proper air flow during the usage. The fan cannot be located immediately below or close to the curtain.
10. Do not obstruct the airflow with any objects or place anything inside the fan opening.
11. Do not use the fan in areas where curtains could be sucked in.
12. Only place the fan on a hard, flat, dry floor.
13. Do not use under extreme temperatures, humidity, or dusty environments.

14. Do not put heavy objects on the fan.
15. Do not place the fan below the power outlet that will suck the cord inside to cause the damage.
16. When the fan is oscillating, do not manually touch the fan to avoid damage.
17. Always turn off the power supply before unplugging the power cord from the electric outlet to avoid a short circuit, fire or electric shock.
18. Do not twist or pull the power cord out.
19. In order to avoid the danger of electric shock, do not unplug the fan when your hands are wet.
20. Children under 8 should not operate the fan.
21. This appliance is not intended for use by people (including children) with reduced physical/sensory/mental capabilities, or people who lack of experience and knowledge. Unless those ones mentioned above are under the supervision or guidance from people who are responsible for their safety.
22. Children should be supervised to ensure that they do not play with the appliance.
23. Ensure that the fan is switched off from the power supply before removing the guard.
24. To reduce the risk of fire or electric shock, do not use this fan with any solid-state speed control device.
25. Please unplug or disconnect the appliance from the power supply before the repair.
26. This product has overload protection (fuse). A blown fuse indicates an overload or short-circuit condition. If the fuse blows, unplug the product from the outlet. Replace the fuse following the user servicing instructions (Choose the appropriate fuse grade according to the product label) and check the product. If the replacement fuse blows, a short-circuit may be present and the product should be discarded or return to an authorized service facility for examination/repair.

Warning:

This appliance has a polarized plug (one blade is wider than the other). To reduce the risk of electric shock, this plug is intended to fit in a polarized outlet only one way. If the plug does not fit fully into the electric receptacle, reverse the plug. If it still does not fit, contact a qualified electrician. Do not attempt to subvert this safety feature alone.

To Change the fuse

The following should ONLY be conducted by a qualified professional person:

1. Grasp plug and remove it from the electric receptacle. Do not unplug by pulling on the cord.
2. Open the fuse cover by sliding the fuse access cover on the top of the plug towards the blades as it is shown in the diagram below.
3. Remove the fuse carefully. Push the fuse from the other side or turn fuse holder upside down to remove fuse.

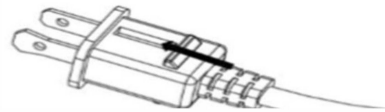

4. Risk of fire. Replace the fuse only with 5 Amp, 125 Volt fuse.
5. Close the fuse cover by sliding the fuse access cover on the top of the plug away from the blades.
6. Risk of fire. Do not replace the polarized plug as it has a safety device that should not be removed.

Discard product if its polarized plug is damaged.

SAVE THESE INSTRUCTIONS

Part 2 Brief introduction

This tower fan is equipped with multiple functions, such as 8 speeds, 3 modes, 360 degree oscillation, 24H timer, remote control and ionizer. With the above functions, our tower fan can provide coolness and a healthy, luxury lifestyle.

Part 3 Specification

MODEL NO	RATED	POWER	CLASS
5304	120V, 60Hz	50W	II

Part 4 Structure and parts

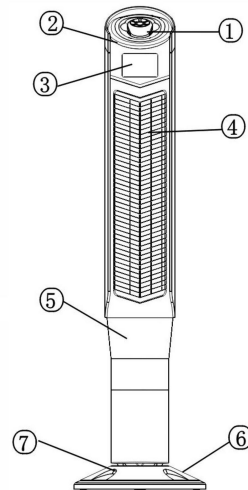

- 1-----control panel
- 2-----head
- 3-----LED screen
- 4-----air outlet
- 5-----support
- 6-----base A
- 7-----base B

Parts list			
Description	Quantity	Description	Quantity
Remote control	1	Instruction manual	1
Base	2	Screws(1) (ST4*12mm)	2
Screws(2) (ST4*16mm)	4		

Part 5 Installing

1. Take out the two bases from the gift box. Forming the base A and B into a unit. (Shown in pic.1) Then fasten base A and base B by 2 pcs screws(1). (Shown in pic.2)

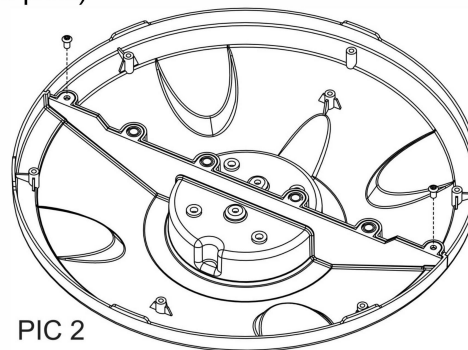
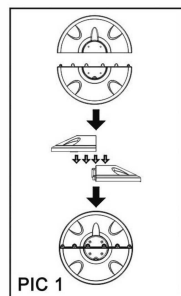

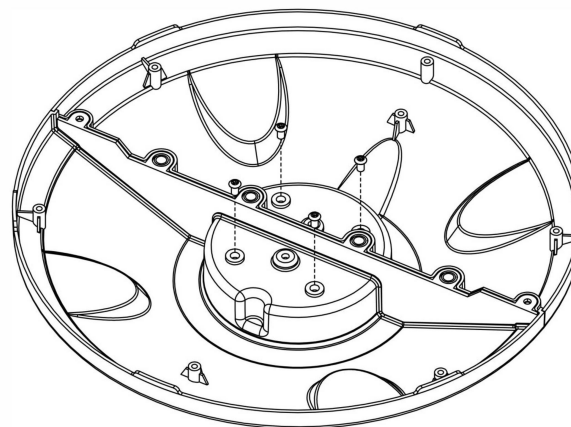
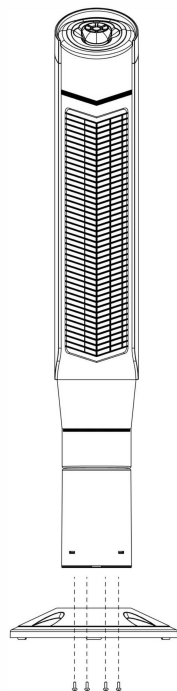

2. Connect fan body with the base by 4 pcs of screws (2). (Shown in below pic)

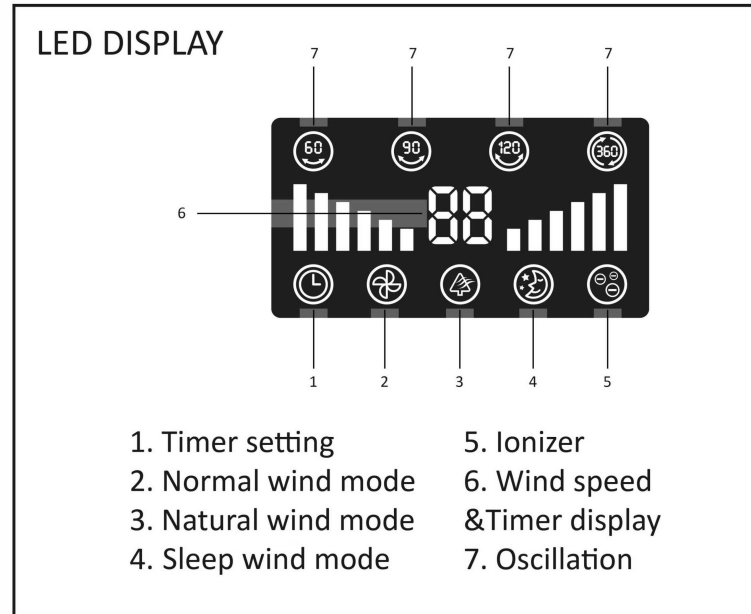

Part 6 Function



1. ON/OFF

Press this ON/OFF button  to turn the fan ON/OFF. Press it once, the fan will start operation and shows the default wind level 5. Press the  button again to stop the fan.

2. Mode

The model has three modes: Normal/ Natural/ Sleeping. When you turn on the fan, the default mode is Normal wind mode. The LED screen will indicate normal wind mode.

Normal wind mode:

The Normal light indicator  will be switched ON when this mode is selected.

Natural wind mode:

The Natural light indicator  will be ON when this mode is selected. The fan will run like real natural wind, alternating between high wind and

low wind.

Sleep wind mode:

The Sleep light indicator  will be ON when mode is selected. The fan will run as current natural wind mode, and reduce 1 natural wind level in every single half an hour. Keep natural wind speed level 1 until it turns off.

3. Oscillation

The oscillation degrees are optional: 60, 90, 120, and 360 degrees.



4. Ionizer

Press Ionizer to start ionizer.

The ionizer light indicator  will be ON when selecting this function.

5. Timer

Press timer, then Press “+” or “-” to choose time duration. The timer is 24 hours. To cancel the timer setting, press the “Timer” button again

and press  button to set as 00 Hr.

6. Wind Speed  

Press “+” or “-” to choose the wind speed range from 1-8.

Part 7 Maintenance and Storage

1. Always remove the plug from the socket-outlet and allow the fan to stop before cleaning it.
2. Clean the external surfaces of the fan with a soft damp cloth (not dripping wet cloth).

WARNING:

Do not immerse the fan into the water.

Do not use any cleaning chemicals such as detergent and abrasive.

Do not allow the interior to get wet as this could cause dangerous problem.

3. When the unit is not in use, make sure that it is unplugged from the wall socket. To store the fan, you may pack it in the original carton and store it in a cool and dry place.

4. In case of malfunction or doubt, do not try to repair the fan yourself, otherwise it may result in a fire hazard or electric shock.

Part 8 After sales service

This appliance has a warranty of 1 year from the date of purchase, considering the following notes:

1. Guarantee is only valid showing the invoice or purchase ticket.

2. Damage caused during transportation, negligence, incorrect installation or installation, and external influences such as atmosphere or electric rays, floods, humidity, etc. are not covered by the guarantee.

3. This warranty will void when it is discovered that they have been subjected to repairs, alterations or interventions by any unauthorized persons.

Thank you for purchasing this product! If you have questions about the product such as missing parts, damaged products, product assembling and operation etc., please contact us via **Amazon Message** or customer service phone: **213-4467172**

IMPORTANT

Simply call our customer service department for any consulting:

213-4467172

(8:30am - 5:30pm P.S.T.)

DATED PROOF OF PURCHASE IS REQUIRED FOR WARRANTY SERVICE.

AVIS

Veuillez appeler le service à la clientèle pour toutes questions au:

213-4467172

(8:30am - 5:30pm P.S.T.)

PREUVE D'ACHAT ORIGINALE REQUISE POUR SERVICE DE GARANTIE.

IMPORTANTE

Sólo hay que llamar nuestro departamento de servicio al cliente en caso de tener preguntas o inquietudes:

213-4467172

(8:30am - 5:30pm P.S.T.)

SE REQUIERE PRUEBA DE COMPRA CON FECHA PARA SERVICIO BAJO GARANTÍA.

Add: 9733 Topanga Canyon Blvd. APT310, Chatsworth, CA 91311

Phone: 213-4467172