

PRODUCT SUPPORT

Chicken Cage Layer Addition H:15"

SKU: TYK40-03-TA

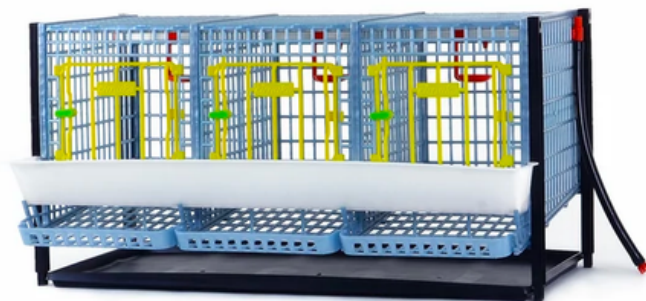

Assembly



[View Assembly Video](#)
(Coming Soon)



[View Assembly Guide](#)

Specifications

Brand	Cimuka
Model	TYK40-03-TA
Material	ABS Plastic
Design	COMFORTPLAST™
Location	Indoors or Enclosed Shelter
Assembly Required	Yes

Recommended Tools



Power Drill
(Phillips Head)



Tape
Measurer



Rubber
Mallet



Rubber
Vise Grips

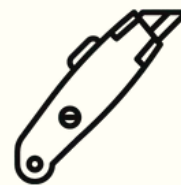

Utility
Knife



Screwdriver
(Flat Head)

Parts List

[View](#)

X 3



Drinker Cup - Series:
GL40/TYK40/TYK60/KYK

SKU: NPA-01

[View](#)

X 1



Nipple Water Pipe - 38
inch 3 nipple T ending

SKU: NPD-P-95-3N-T-K

[View](#)

X 1



External Hose - Fits
CB40/GL40/KYK/TYK40

SKU: HRT-01-15-E

[View](#)

X 1



End Connector -
Fits Water Hose

SKU: HRT-01-C-E

[View](#)

X 1

Green Connector
Comes Attached

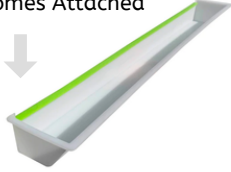

Feeding Trough: 3 Sections
Series: CB40/GL40/TYK/KYK

SKU: FD-CG-P-95L

[View](#)

X 3

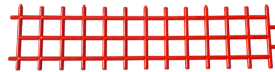

Feed Grill Cover
- 1 Section

SKU: FD-GRL1

[View](#)

X 2

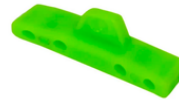

Feed Grill
Connector

SKU: FD-GRL-C

[View](#)

X 1



Manure Tray -
Full Layer

SKU: MT03

[View](#)

X 3



Front Door -
Series: TYK40

SKU: BS_K0054

[View](#)

X 3

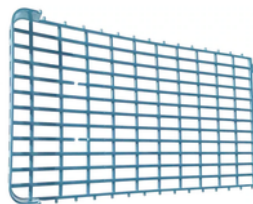

Egg Roller -
Series: TYK40/TYK60

SKU: BS_K0036

[View](#)

X 3



Front Wall -
Series: TYK40/KYK

SKU: BS_K0060

[View](#)

X 3



Back Wall -
Series: KYK/TYK40

SKU: BS_K0041

[View](#)

X 3

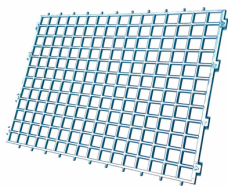

Roof - Series:
GL40/BYK/KYK/TYK

SKU: BS_K0063

[View](#)

X 4



Side Wall -
Series: TYK40

SKU: BS_K0066

[View](#)

X 4



Side Strut: Medium - Series:
CB40/GL40/TYK40/KYK

SKU: BS_K0012

[View](#)

X 4



Aluminum
Rod

SKU: ALO24

Parts List (Continued)

[View](#)

X 8



Molly for Comfortplast
Cage Systems

SKU: HRT-01-C-E

[View](#)

X 8



Screw for Comfortplast
Cage Systems

SKU: VD078

[View](#)

REPLACEMENT
(Sold Separately)



Replacement Connector for
Feeding Trough: 3 Sections -
Series: CB40/GL40/TYK/KYK

SKU: BS_K0090

[View](#)

REPLACEMENT
(Sold Separately)



Green Door Lock
for Cage Systems

SKU: BS_K0067

[View](#)

REPLACEMENT
(Sold Separately)



Plastic Nipple
180 degree

SKU: NP-01

Parts Needed To Convert To Full Layer (Parts Sold Separately)

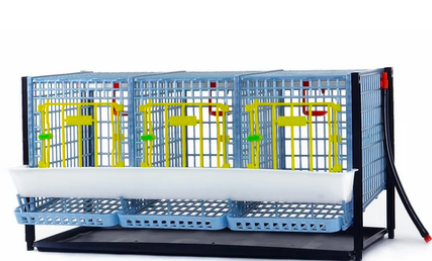

TYK40-03-TA



TYK40-03-1K

Conversion Kit Parts

[View](#) X 1



Water Tank
(2 Gallon)

SKU: BS_K0022

[View](#) X 1



Lid - Fits Water Tank
(2 & 5 Gallon)

SKU: BS_K0072

[View](#) X 1



Water Tank Connector
to Water Hose

SKU: HRT-01-C-R1

[View](#) X 1



External Hose - Fits
CB40/GL40/KYK/TYK40

SKU: HRT-01-15-E

[View](#) X 1



Top Frame -
Layer Units

SKU: BS_K0044

[View](#) X 1



Bottom Frame -
Layer Units

SKU: BS_K0043

[View](#) X 2



Rolling
Wheel

SKU: SA_M0009

[View](#) X 2

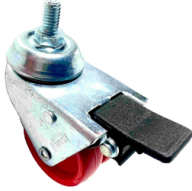

Rolling Wheel -
with Lock

SKU: SA_M0008



Need More Help?
(800) 511-1369
support@hatchingtime.com