

ASSEMBLY INSTRUCTION

Item No.: A304001200

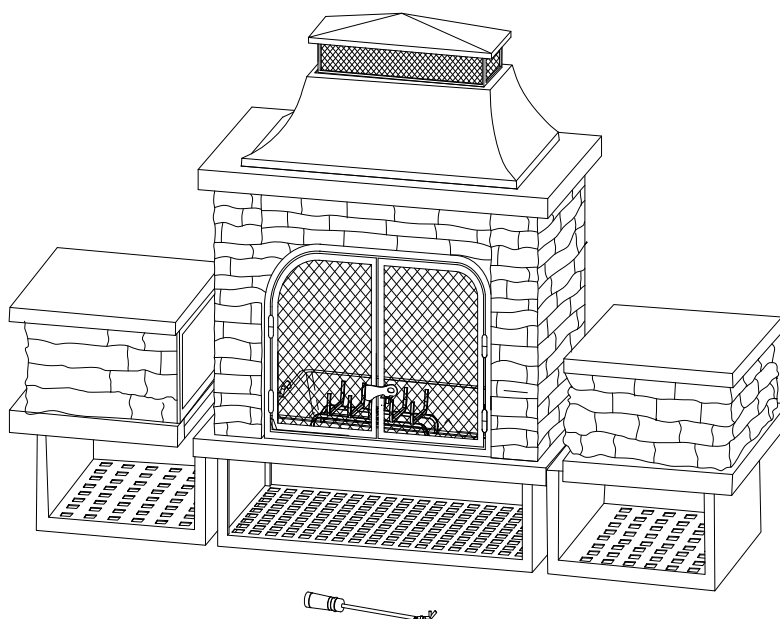

WE HAVE YOU IN MIND, LET US SERVE YOU!

Questions? Issues?

CONTACT US

24 hours / 7 days a week

? Warranty Parts

www.sunjoyonline.com



customer.care@sunjoygroup.com



A30400120022

Warnings

This Fireplace is intended for outdoor use only. NEVER LEAVE A FIRE UNATTENDED.





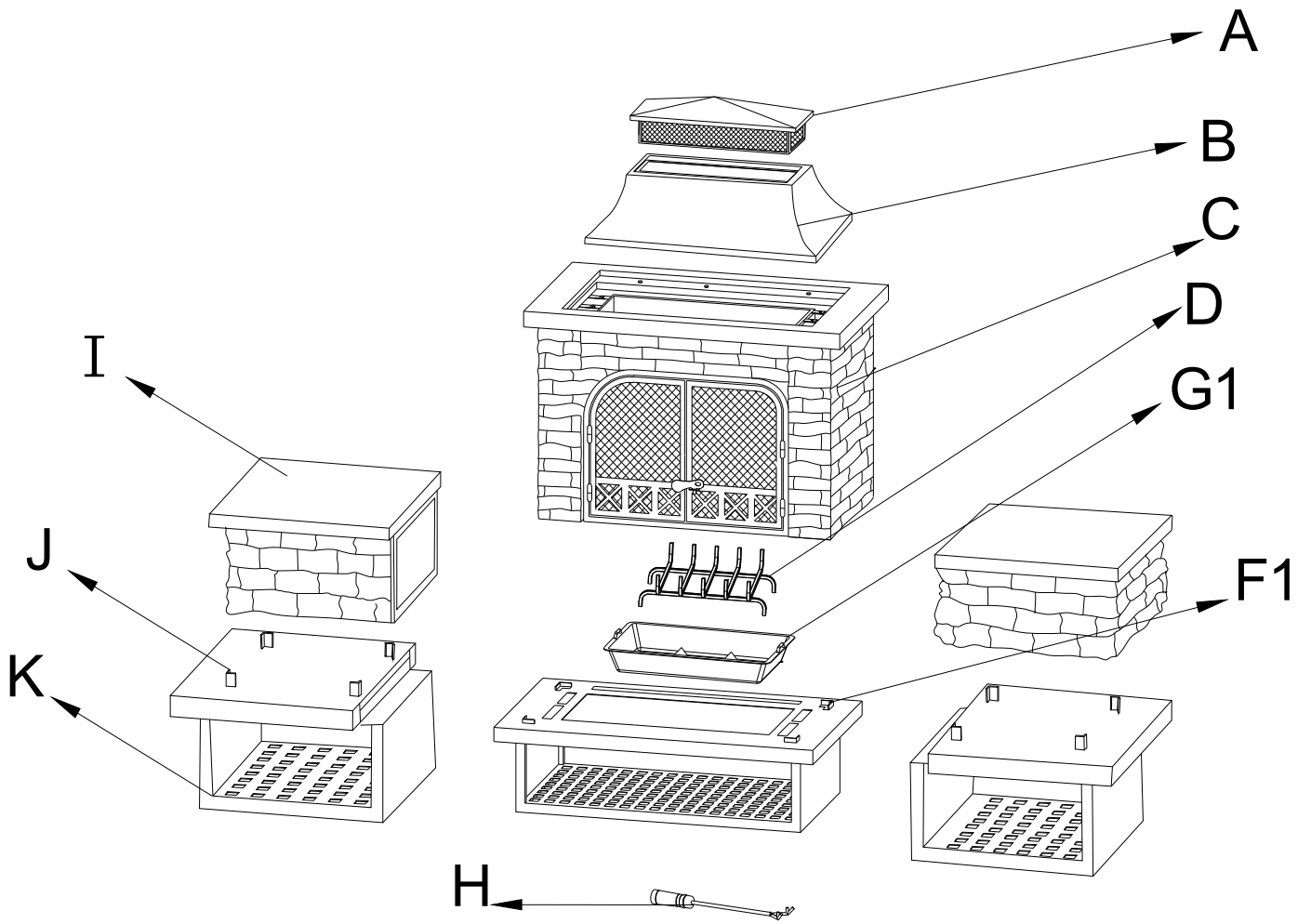

- DO NOT use the fireplace to cook food. The fireplace is not designed for grilling food.
- DO NOT allow children or pets near the fireplace without supervision.
- DO NOT touch the surface of the fireplace while in use as it may cause burns.
- NEVER burn in vehicles, tents or indoors. CARBON MONOXIDE HAZARD.
- Use a poker and / or heat-resistant gloves to open / close the mesh cover while in use.
- DO NOT use water to extinguish as this is dangerous and can cause damage to the fireplace.
- Burn only untreated wood or fire logs in this fireplace.
- DO NOT use gasoline or kerosene to start the fire in this fireplace.
- Only place/use this fireplace on stable and non-combustible surfaces.
- DO NOT attempt to move the fireplace while it is hot or in use.
- Place the fireplace no closer than 8' (2.4 m) from walls or combustibles during use.
- Adequate fire extinguishing material should be readily available.
- Always ensure that the mesh cover is secured over the fireplace while in use.
- The poker handle may become hot during and after use.
- Check local fire regulations and municipal by-laws for information regarding the safe use of this fire bowl.
- The maximum amount of firewood should be stacked no higher than 1/3 of the fireplace chamber inside height.
- NEVER leave a burning fire unattended when in use. Always extinguish fire completely before leaving it. DO NOT COVER THE UNIT UNTIL FIRE HAS BEEN EXTINGUISHED FOR 24 HOURS.
- Always use caution while using your fire place.
- DO NOT attempt to storage wood or fire logs on the rack under the fireplace while it is hot or in use. This rack is for storage wood or fire logs when the fireplace is COMPLETELY out and cool to touch, or when it's not in use.



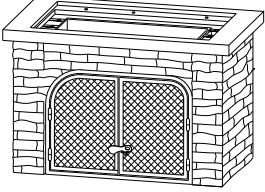

Exploded Drawing

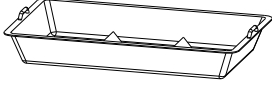
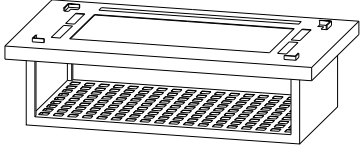

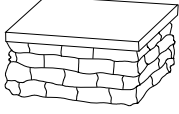
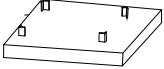
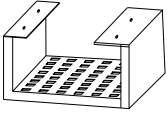
Parts List

Label	Part Number	Description	Qty	Part Image
A	P000900085	Chimney	1	
B	P000300048	Top	1	
C	P007900044	Body	1	
D	P002800026	Grate	1	
G1	P003000013	Ash Tray	1	
F1	P000100284	Base	1	
H	P002700014	Porker	1	
I	P000100287	Side Table Top	2	
J	P000100285	Upper Side Base	2	
K	P000100286	Lower Side Base	2	

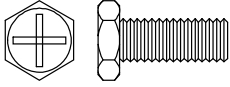
Hardware Pack

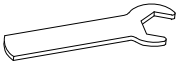
Label	Part Number	Description	Qty	Part Image
AA	H010020011	Bolt M6*15	8	
BB	H050030001	Flat washer M6	8	
CC	H090010017	Wrench M6	1	

Assembly Steps

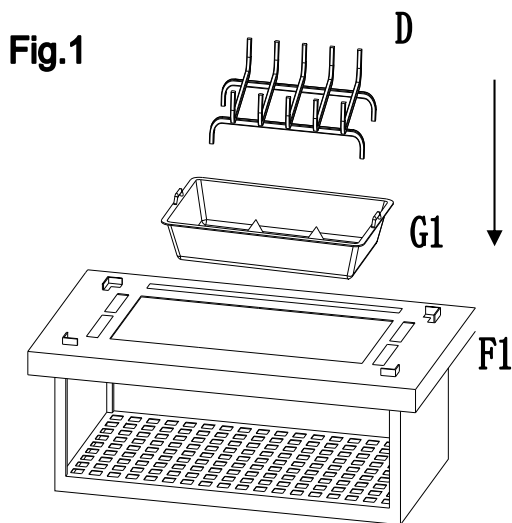

Fig.1: Put Grate (D) in Ash tray (G1), then insert the Ash tray (G1) into Base (F1).

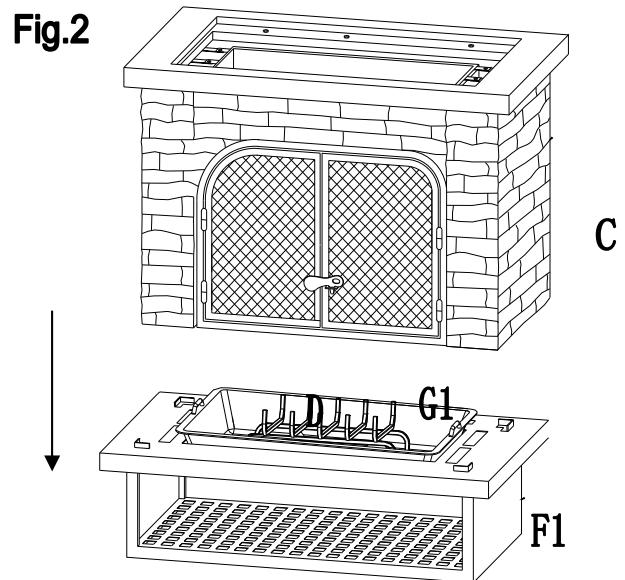

Fig.2: Place Body (C) onto base (F1)

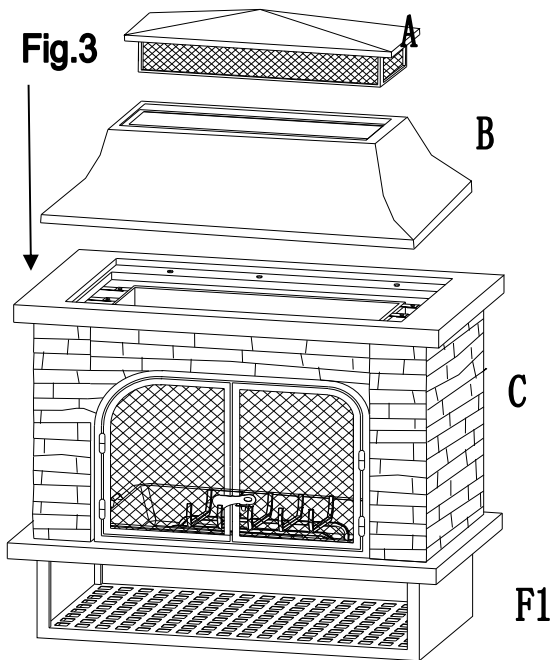

Fig.3: Put top (B) on body (C) and chimney (A) on top (B) in order as Fig.3

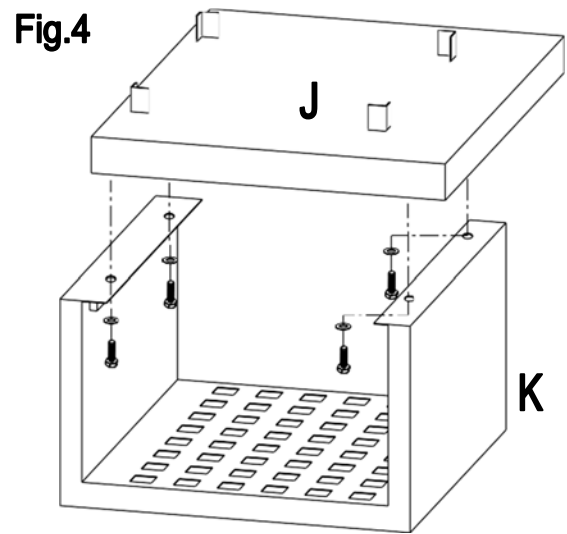

Fig.4: Attach upper side base (J) and lower side base (K) with bolt (AA) and flat washer (BB), as Fig.4

Fig.5

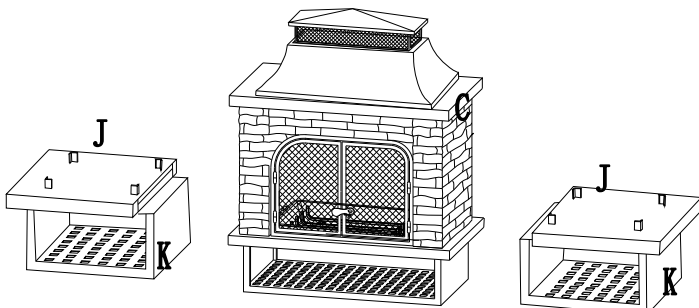

Fig.5: Insert the assembled side base (K) into Body (C).

Fig.6

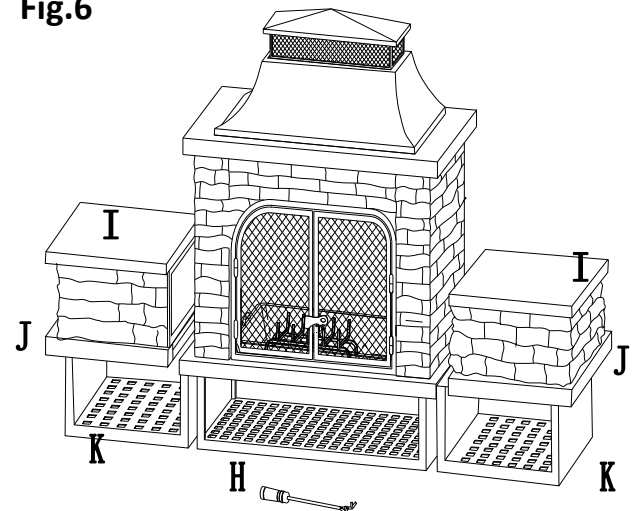

Fig.6: Put the side table top (I) on assumed side base (J&K). (Note: The table top side without stone should face the body). Use Poker (H) as necessary. Now, your fireplace is ready for use.

Cleaning and Maintenance



Caution!

Check all screws and nuts periodically for tightness, fastening them again as required.

Lighting

- Make sure there is only a small amount of ash in the bottom of the bowl.
- Place a layer of dry seasoned hardwood that covers no more than 3/4 of the bowl.
- Use a match to light kindling or fire starter.
- Use the poker that is provided to operate. Please wear heat-resistant gloves during use.

Extinguishing

- Allow fire to burn itself out.
- DO NOT use water to extinguish as this is dangerous and can damage this fireplace.

Cleaning

- This fireplace should be cleaned on a regular basis to promote safer experience and long product life.
- DO NOT attempt to clean this fireplace until the fire is COMPLETELY out and cool to touch.
- DO NOT use oven cleaner or abrasive cleaner as this will damage the fire bowl.

Storage

- DO NOT move or store this fireplace until the fire is COMPLETELY out and cool to touch.
- Store the fireplace in a dry location to maximize product life.
- Store assembled fireplace in a location away from children and pets.

LIMITED WARRANTY

This limited warranty is extended to the original purchaser and applies to defects in material and workmanship of your item provided the item is maintained with care and used only for personal, residential purposes. The manufacturer Sunjoy Group warrants this item is free of defects in material and workmanship for a period of **ONE YEAR**. If any defect is found, please call our Sunjoy Group customer service department at **customer.care@sunjoygroup.com** for help. The manufacturer Sunjoy Group will not cover transportation or delivery costs or compensate the individual or any outside party for assembling or disassembling the product.