

ASSEMBLY INSTRUCTION
Item/Article #: A102012800

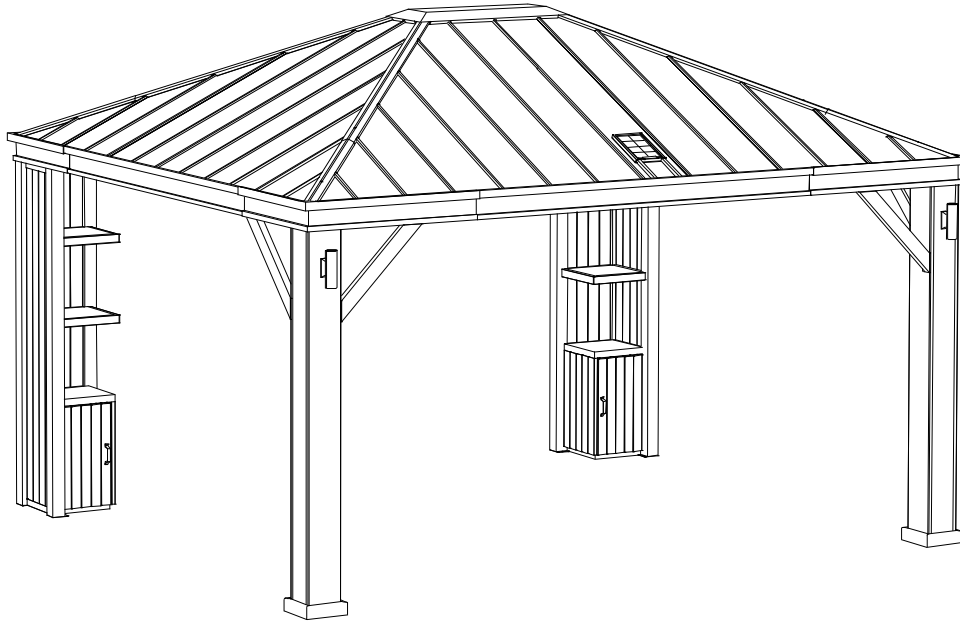

WE HAVE YOU IN MIND, LET US SERVE YOU!
Nous pensons en vous, laissez nous vous aider!

Questions? Issues? / Questions? Problèmes?

CONTACT US / Contactez-nous

24 hours / 7 days a week
24 heures / 7 jours par semaine

Warranty Parts
Liste des pièces sous
garantie



www.sunjoyonline.com



customer.care@sunjoygroup.com



A10201280022

Country of Origin: China
Pais d'origine: Chine

Production Number: XXXXXXXXXX
Numéro de fabrication: XXXXXXXXX

Important Safety Instructions



Warning! To reduce the risk of serious injury, read the following safety instructions before assembling and using the gazebo.

Please check with your local governing authority/local municipal codes regarding installation of structures before assembly.

Caution! Proper placement of your gazebo is essential.

Do not place the product underneath electrical lines.

Keep children away during assembly.

This product contains small parts which can be swallowed by children.

Keep fingers away from the places where they can be pinched or trapped.

Do not attempt to assemble the gazebo if any parts are missing.

- This product is intended for domestic outdoor use only.
- The product should be placed on flat, horizontal ground.
- Ensure enough clearance around the product. Before assembling the product, find level ground not less than 6' (1.8 m) away from any structures or obstructions, such as fences, garages, houses, overhanging branches, laundry lines, or electrical wires.
- This gazebo is not to be regarded as part of a building/house structure. The gazebo is to be anchored onto the ground for added safety. Do not assemble the gazebo onto soil/earth ground. It is best advisable to have the gazebo built onto a wooden deck or concrete ground for stability. If it is to be build onto a wooden deck/ground, do ensure that the wooden deck/ground has a strong foundation. It is advisable to use appropriate floor plugs (not provided) to anchor the gazebo onto the wooden/concrete ground.
- Some structures may require two or more people to install safely. Check for underground utilities before digging or driving stakes into the ground.
- During installation, follow all safety warnings provided with your tools, and use safety glasses.
- In case you set up more than one gazebo, keep a minimum distance of 10' (3 m) between the gazebos.
- Any assembly or maintenance of the product must be carried out by adults only.
- Arrange necessary manpower when assembling or moving the product.
- Some parts may contain sharp edges. Wear protective gloves if necessary.
- Keep children and pets away while setting up the gazebo.
- Check all nuts and bolts periodically to ensure bolts/nuts are tightened.
- Repairing and replacing parts should be done by a qualified technician.
- This gazebo is intended for decorative and sunshade purposes only, and it is not designed to withstand harsh weather, including high winds, rain, and snow.
- Do not light any fires inside or near the product !
- Stay calm if fire breaks out. Search for the nearest exit. Do not return to the gazebo before firemen allow you to do so.
- Do not hang heavy weights on the roof frame.
- Do not climb onto the roof of the gazebo. Falling off the gazebo can result in serious injury.
- Retain the original packaging to store the gazebo.

Country of Origin: China

Pais d'origine: Chine

Consignes de sécurité importantes



Avertissement! Veuillez lire les consignes de sécurité suivantes avant d'assembler et d'utiliser l'abri de jardin afin de réduire le risque de blessures graves. Veuillez vous renseigner auprès des autorités locales concernant les codes municipaux à l'égard de l'installation des structures avant d'effectuer tout montage

ATTENTION! L'emplacement approprié de l'abri de jardin est essentiel.

Ne placez pas le produit en dessous de fils électriques.

Tenez les enfants à l'écart du produit pendant son assemblage.

Ce produit contient des petites pièces que les enfants peuvent avaler.

Tenez vos doigts éloignés des endroits où ils risquent d'être pincés ou blessés.

Ne tentez pas d'assembler l'abri de jardin s'il vous manque des pièces.

- Ce produit est uniquement destiné à un usage domestique et doit être utilisé à l'extérieur.
- L'abri de jardin doit être placé sur une surface plane et horizontale.
- Prévoyez un espace dégagé suffisant autour du produit. Avant de procéder à l'assemblage du produit, choisissez une surface au sol plane et éloignée d'au moins 6 pi (1,8 m) des structures ou obstructions environnantes, comme les clôtures, garages, maisons, branches surplombantes, cordes à linge ou fils électriques.
- Ce gazébo ne doit pas être considéré comme faisant partie d'une structure de bâtiment ou maison. Le gazébo doit être ancré à la terre pour plus de sécurité. Ne construisez pas le gazébo sur la terre ou le sol. Il est préférable de construire le gazébo sur une terrasse en bois ou ciment ou béton pour la stabilité. Si le gazébo doit être construit sur une terrasse en bois ou la terre, assurez-vous que la terrasse ou la terre a une base solide. Il est recommandé d'utiliser les boulons d'ancrage (pas compris) convenables pour ancrer le gazébo sur la surface en bois ou en ciment.
- Certaines structures peuvent nécessiter deux personnes ou plus pour l'installer en toute sécurité. Vérifiez les services publics souterrains avant de creuser ou d'enfoncer des piquets dans le sol.
- Lors de l'installation, suivez toutes les consignes de sécurité fournies avec vos outils et portez des lunettes de sécurité.
- Si vous installez plus d'un abri de jardin, gardez une distance minimale de 10 pi (3 m) entre les abris de jardin.
- L'assemblage et l'entretien de ce produit ne doivent être effectués que par des adultes.
- Au besoin, demandez à d'autres personnes de vous aider à assembler ou déplacer le produit.
- Certaines pièces peuvent contenir des bords tranchants. Portez des gants de protection si nécessaire.
- Tenez les enfants et les animaux à l'écart de l'abri de jardin pendant son assemblage.
- Assurez-vous périodiquement que tous les écrous et boulons pour s'assurer que les boulons / écrous sont serrés.
- La réparation et le remplacement des pièces doivent être effectués par un technicien qualifié.
- Cet abri de jardin est conçu uniquement pour des fins décoratives et de pare-soleil, et il n'est pas conçu pour résister aux intempéries, notamment les vents violents, la pluie et la neige.
- N'allumez pas un feu à l'intérieur ou près du produit!
- Si un incendie se déclare, restez calme. Cherchez la sortie la plus proche. Ne retournez pas à l'abri de jardin avant que.
- les pompiers ne vous le permettent.
- Ne suspendez aucun poids lourd sur le cadre du toit. Ne montez pas sur le toit de l'abri de jardin. Tomber de l'abri de jardin peut entraîner des blessures graves.
- Conservez l'emballage original aux fins de remisage de l'abri de jardin.

Country of Origin: China

Pais d'origine: Chine

IMPORTANT:

- Please read and understand this manual before any assembly. Before beginning assembly of product, make sure all parts are present. Compare parts with packaging contents list.
- When assembling wooden parts, do not overtorque the bolts to avoid splitting the wood. See image illustration.
- Place all parts from the box in a cleared area and position them on the floor in front of you.
- Remove all packing materials and place them back into the box. Do not dispose of the packing materials until assembly is complete.
- Read each step carefully before beginning any assembly and make sure you understand each step. If you are missing a part, please email customer.care@sunjoygroup.com.
- Needed for assembly: (The following tools are not included)

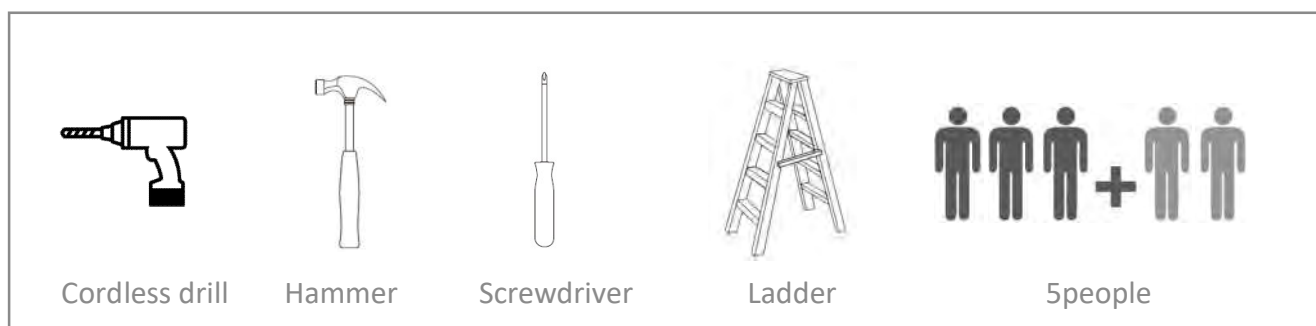

This identifies information that requires special attention. Improper assembly could lead to an unsafe or dangerous condition.

**Use Level**

Check that set or assembly is properly level before proceeding.

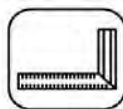
**Square Assembly**

Check that assembly is square before tightening bolts.

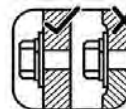
**Tighten Bolts**

Do not overtorque mounting bolts. Over-tightening may cause the wood to crack creating splinters and other structural damage.

**Measure Distance**

IMPORTANT:

- Veuillez lire et bien comprendre ce guide avant de procéder à l'assemblage. Avant de procéder à l'assemblage du produit, assurez-vous que toutes les pièces sont présentes.
- Lors de l'assemblage de pièces en bois, ne serrez pas trop les boulons afin d'éviter de fendre le bois.
- Consultez l'illustration dans les schémas. Mettez toutes les pièces de la boîte dans une zone dégagée et positionnez-les sur le sol devant vous.
- Retirez tous les matériels d'emballage et remettez-les dans la boîte. Ne les jetez pas avant d'avoir terminé l'assemblage.
- Nécessaire pour l'assemblage : les outils suivants ne sont pas inclus.

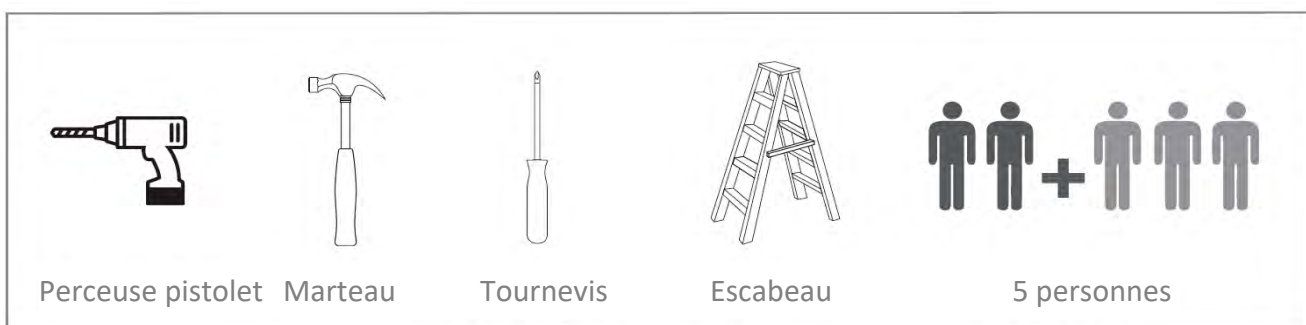

Cette icône identifie de l'information
Utilisez un niveau Vérifiez avec un
équerre Serrer les boulons Mesurer
la distance

**Utilisez un niveau**

Vérifiez que l'assemblage est d'aplomb
avant de procéder à la prochaine étape.

**Vérifiez avec un équerre**

Vérifiez que l'assemblage est carré avant
de serrer les boulons.

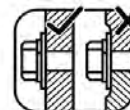
**Serrer les boulons**

Ne serrez pas trop les boulons de fixation. Un
serrage excessif peut provoquer des fissures
dans le bois, créant des éclats de bois et d'autres
dommages structurels

**Mesurer la distance**

Country of Origin: China

Pais d'origine: Chine

EXPLODED DRAWING/ DESSIN ÉCLATÉ

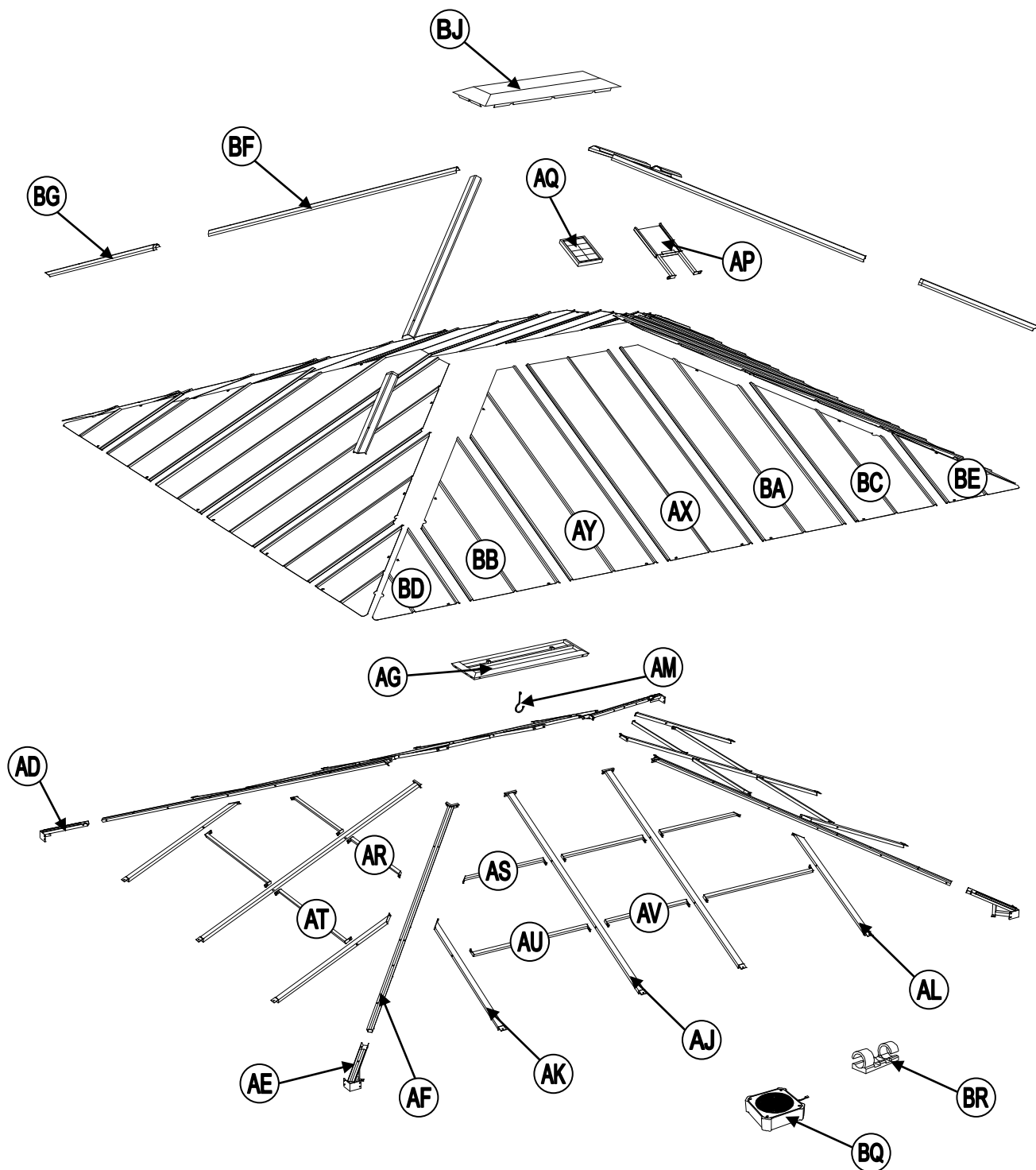





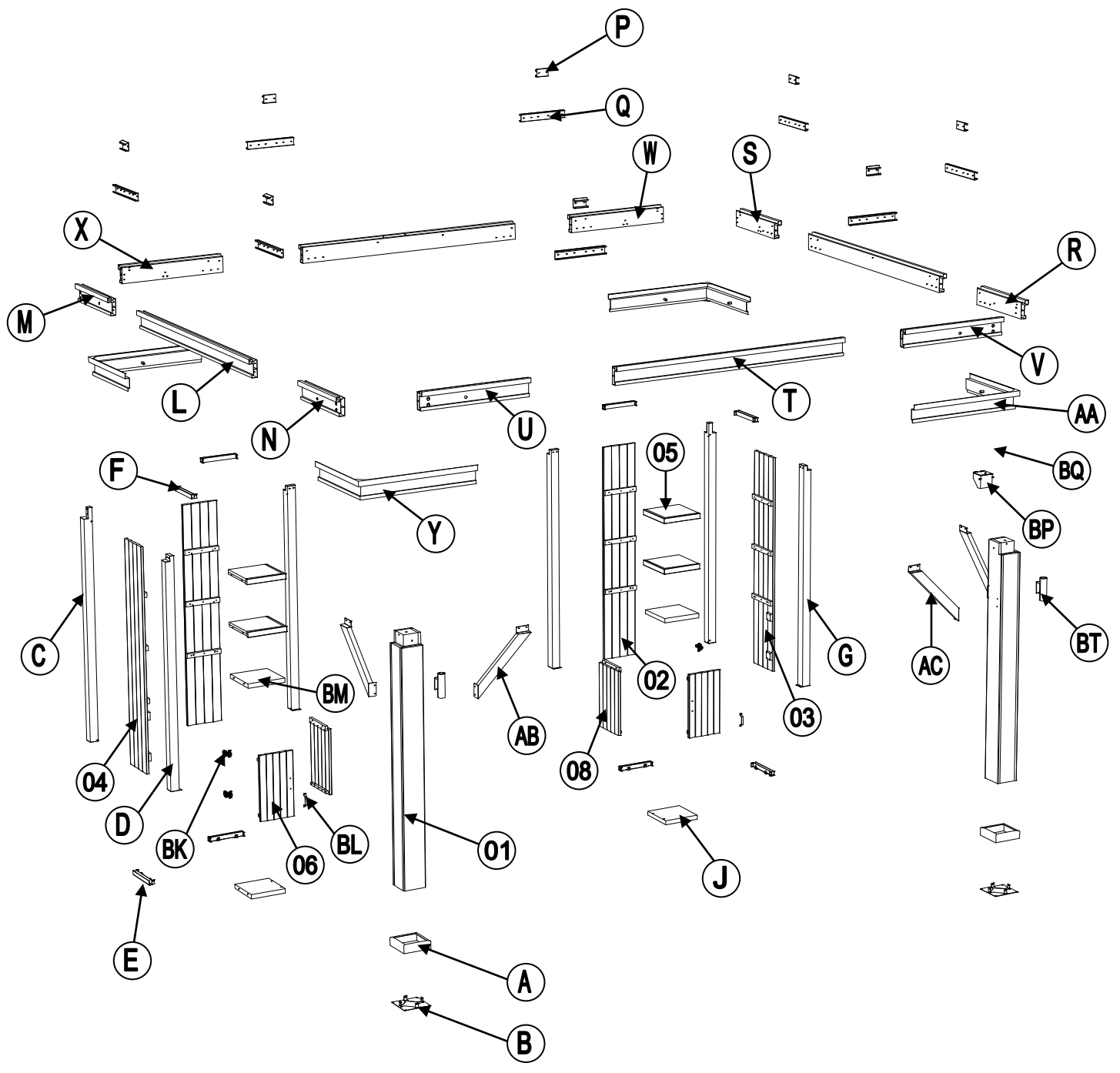

Country of Origin: China
Pais d'origine: Chine

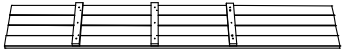
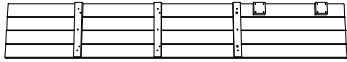
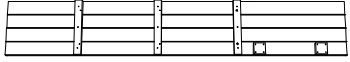

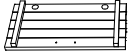
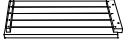

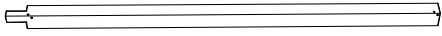



EXPLODED DRAWING/ DESSIN ÉCLATÉ



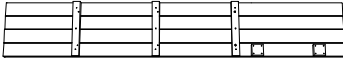

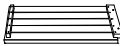

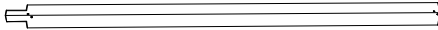
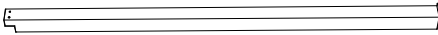
Country of Origin: China
Pais d'origine: Chine

Parts List				
Label	Part Number	Description	Qty	Part Image
01	P00020068001	Post 1	2	
02	P00630012701	Screen 1	2	
03	P00630012801	Screen 2	1	
04	P00630012901	Screen 3	1	
05	P00230009501	Shelf	4	
06	P00410017201	Storage Door Panel 1	2	
08	P00380063901	Storage Side Panel	2	
A	P00610023401	Base Cover	2	
B	P00010046201	Post Base	2	
C	P00020068301	Post 4	2	
D	P00020068101	Post 2	2	
E	P00010046301	Screen Base	4	





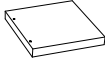
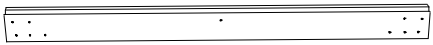
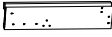
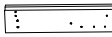

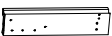
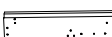
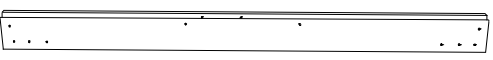
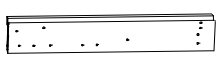
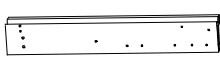

Country of Origin: China
Pais d'origine: Chine

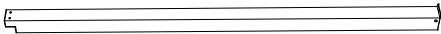
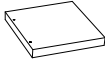
Liste de Pièces				
Étiquette	Numéro de la Pièce	Description	Quantité	Numéro de la Pièce Diagramme
01	P00020068001	Poteau 1	2	
02	P00630012701	Façade 1	2	
03	P00630012801	Façade 2	1	
04	P00630012901	Façade 3	1	
05	P00230009501	Étagère	4	
06	P00410017201	Panneau de la Porte du Coffre de Stockage 1	2	
08	P00380063901	Panneau Latéral du Coffre de Stockage	2	
A	P00610023401	Barde de la base	2	
B	P00010046201	Poteau Base	2	
C	P00020068301	Poteau 4	2	
D	P00020068101	Poteau 2	2	
E	P00010046301	Façade Base	4	

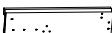
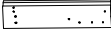
Country of Origin: China
Pais d'origine: Chine

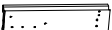



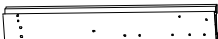





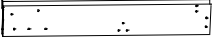
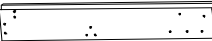

F	P00070106101	Screen Cover	4	
G	P00020068201	Post 3	2	
J	P00010046401	Storage Base 1	2	
L	P00040129801	Middle Gutter (Short Side)	2	
M	P00040130501	Short Side Left Gutter (For Steel Post)	1	
N	P00040130601	Short Side Right Gutter (For Wood Post)	1	
P	P00050028101	Cross Beam Connector 2	8	
Q	P00050028001	Cross Beam Connector 1	8	
R	P00040130301	Short Side Left Gutter (For Wood Post)	1	
S	P00040130401	Short Side Right Gutter (For Steel Post)	1	
T	P00040129701	Middle Gutter (Long Side)	2	
U	P00040129901	Long Side Left Gutter (For Wood Post)	1	
V	P00040130001	Long Side Right Gutter (For Wood Post)	1	

Country of Origin: China
Pais d'origine: Chine











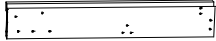
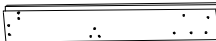

F	P00070106101	Façade couverture	4	
G	P00020068201	Poteau 3	2	
J	P00010046401	Base du Coffre de Stockage 1	2	
L	P00040129801	Canal Central (Côté Court)	2	
M	P00040130501	Canal Gauche Côté Court (Pour Poteau en Acier)	1	
N	P00040130601	Canal Droit Côté Court (Pour Poteau en Bois)	1	
P	P00050028101	Connexion de la Traverse 2	8	
Q	P00050028001	Connexion de la Traverse1	8	
R	P00040130301	Canal Gauche Côté Court (Pour Poteau en Bois)	1	
S	P00040130401	Canal Droit Côté Court (Pour Poteau en Acier)	1	
T	P00040129701	Canal Central (Côté Long)	2	
U	P00040129901	Canal Gauche Côté Long (Pour Poteau en Bois)	1	
V	P00040130001	Canal Droit Côté Long (Pour Poteau en Bois)	1	

Country of Origin: China









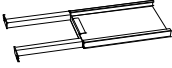
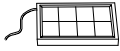

Pais d'origine: Chine

W	P00040130101	Long Side Left Gutter (For Steel Post)	1	
X	P00040130201	Long Side Right Gutter (For Steel Post)	1	
Y	P00220018101	Post Cap 1	2	
AA	P00220018301	Post Cap 2	2	
AB	P00500064301	Brace 1	2	
AC	P00500064401	Brace 2	2	
AD	P00060218601	Rafter Connector 2	2	
AE	P00060218501	Rafter Connector 1	2	
AF	P00060218401	Rafter	4	
AG	P00060218701	Roof Frame	1	
AJ	P00060218101	Long Middle Beam	6	
AK	P00060218201	Short Middle Beam 1	4	
AL	P00060218301	Short Middle Beam 2	4	
AM	P005800001	Hook	1	

Country of Origin: China
Pais d'origine: Chine

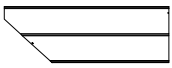
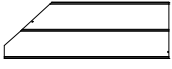

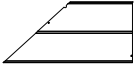





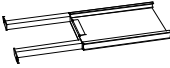
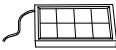

W	P00040130101	Canal Gauche Côté Long (Pour Poteau en Acier)	1	
X	P00040130201	Canal Droit Côté Long (Pour Poteau en Acier)	1	
Y	P00220018101	Pommeau du Poteau 1	2	
AA	P00220018301	Pommeau du Poteau 2	2	
AB	P00500064301	Barre de Renfort 1	2	
AC	P00500064401	Barre de Renfort 2	2	
AD	P00060218601	Connexion du Chevron 2	2	
AE	P00060218501	Connexion du Chevron1	2	
AF	P00060218401	chevron	4	
AG	P00060218701	Cadre de toit	1	
AJ	P00060218101	Longue Poutre Centrale	6	
AK	P00060218201	Courte outre Centrale 1	4	
AL	P00060218301	Courte outre Centrale 2	4	
AM	P005800001	Crochet	1	

Country of Origin: China
Pais d'origine: Chine

AP	P00220034602	Fixed Panel	1	
AQ	P00760012501	Solar Panel	1	
AR	P00060219101	Upper Small Beam (Short Side)	4	
AS	P00060218901	Upper Small Beam (Long Side)	4	
AT	P00060219201	Lower Small Beam (Short Side)	4	
AU	P00060219001	Lower Small Beam (Long Side)	4	
AV	P00060218801	Middle Small Beam (Long Side)	4	
AX	P00070106301	Middle Lower Roof Panel (Long Side)	2	
AY	P00070106401	Roof Panel (Left)	4	
BA	P00070106501	Roof Panel (Right)	4	
BB	P00070106601	Roof Panel (Left Middle)	4	
BC	P00070106701	Roof Panel (Right Middle)	4	
BD	P00070106801	Roof Small Panel (Left)	4	
BE	P00070106901	Roof Small Panel (Right)	4	

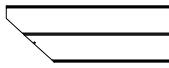

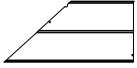





Country of Origin: China





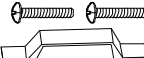



Pais d'origine: Chine





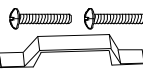

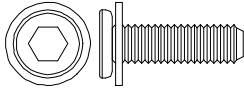
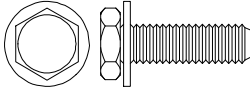
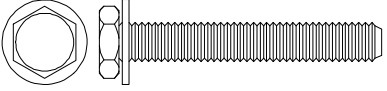
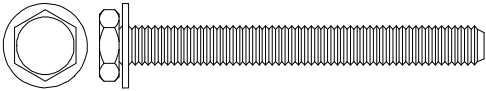
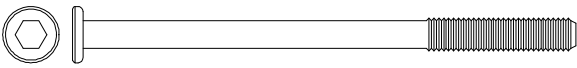
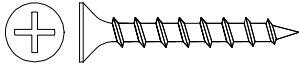
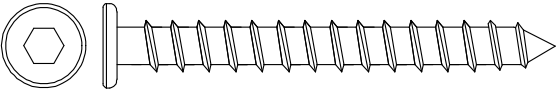
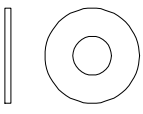
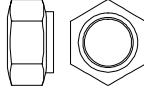
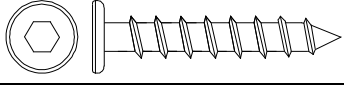

AP	P00220034602	Panneau de Fixation	1	
AQ	P00760012501	Panneau Solaire	1	
AR	P00060219101	Poutre Supérieure Petite (Côté courte)	4	
AS	P00060218901	Poutre Supérieure Petite (Côté Long)	4	
AT	P00060219201	Poutre Inférieure Petite (Côté courte)	4	
AU	P00060219001	Poutre Inférieure Petite (Côté Long)	4	
AV	P00060218801	Poutre Centrale Petite (Côté Long)	4	
AX	P00070106301	Panneau Central Inférieur du Toit (Côté Long)	2	
AY	P00070106401	Panneau du Toit (la gauche)	4	
BA	P00070106501	Panneau du Toit (Droit)	4	
BB	P00070106601	Panneau du Toit (Milieu gauche)	4	
BC	P00070106701	Panneau du Toit (Milieu Droit)	4	
BD	P00070106801	Panneau Petit du Toit (Gauche)	4	
BE	P00070106901	Panneau Petit du Toit (Droit)	4	

Country of Origin: China

Pais d'origine: Chine





BF	P00080037001	Rafter Upper Cover	4	
BG	P00080037101	Rafter Lower Cover	4	
BJ	P00090016901	Roof Cap	1	
BK	P00510038101	Soft Close Hinge	2	
BL	P00510036101	Storage Door Handle	2	
BM	P00210050801	Storage Table Top 1	2	
BP	P00220020601	Bluetooth Container	1	
BQ	P007600005	Bluetooth	1	
BR	P007600006	Lock	6	

BF	P00080037001	Bâche du Chevron Supérieur	4	
BG	P00080037101	Bâche du Chevron Inférieur	4	
BJ	P00090016901	Pommeau du Toit	1	
BK	P00510038101	Charnière à amortissement	2	
BL	P00510036101	Manche de la Porte du Coffre de Stockage	2	
BM	P00210050801	Dessus de Table du Coffre de Stockage 1	2	
BP	P00220020601	Caisse du Bluetooth	1	
BQ	P007600005	Bluetooth	1	
BR	P007600006	Verrouillage	6	

Hardware Pack					
Label	Part Number	Description	Qty	Add	Part Image
H2	H100040010	Bolt M6*20	8	1	
H3	H100010047	Bolt M6*20	260	13	
H4	H100010046	Bolt M6*40	42	3	
H5	H100010051	Bolt M6*55	8	1	
H6	H010030536	Bolt M10*180	4	1	
H7	H030050052	Screw ST4.8*25	22	2	
H9	H030030022	Screw ST 9.5*60	4	1	
H10	H050070014	Washer M10	12	1	
H11	H040050026	Hex Nut M10	4	1	
H12	H030030021	Screw ST8*25	8	1	
H13	H050080007	Flat Washer M8	8	1	
HS	H070010001	Stake Ø8*180	8	0	
HW1	H090010017	Wrench M6	2	0	
HW2	H090010015	Wrench M10	1	0	
HW3	H090030002	Allen Key M6	1	0	
HW4	H090030008	Allen Key M10	1	0	
HW5	H090030005	Allen Key M8	1	0	

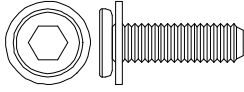
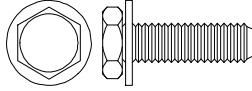
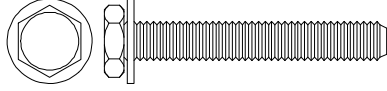
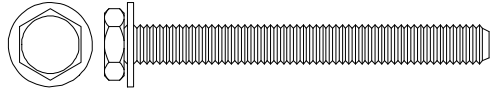
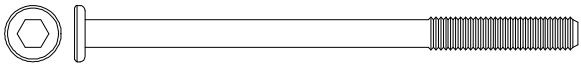
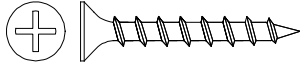
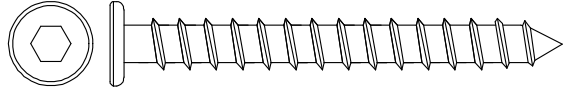
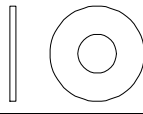
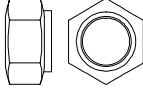
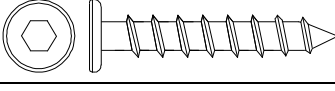
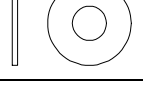
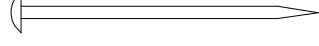
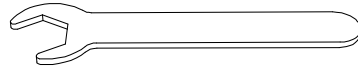
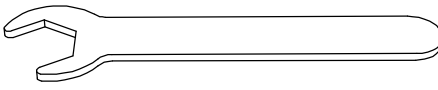
Country of Origin: China

Pais d'origine: Chine

Pack Quincaillerie					
Étiquette	Numéro de la Pièce	Description	Quantité	Add	Numéro de la Pièce Diagramme
H2	H100040010	Boulon M6*20	8	1	
H3	H100010047	Boulon M6*20	260	13	
H4	H100010046	Boulon M6*40	42	3	
H5	H100010051	Boulon M6*55	8	1	
H6	H010030536	Boulon M10*180	4	1	
H7	H030050052	Vis ST 4.8*25	22	2	
H9	H030030022	Vis ST 9.5*60	4	1	
H10	H050070014	Rondelle plate M10	12	1	
H11	H040050026	Écrou Hexagonal M10	4	1	
H12	H030030021	Vis ST8*25	8	1	
H13	H050080007	Rondelle plate M8	8	1	
HS	H070010001	Piquet Ø8*180	8	0	
HW1	H090010017	Clé M6	2	0	
HW2	H090010015	Clé M10	1	0	
HW3	H090030002	Clé Allen M6	1	0	
HW4	H090030008	Clé Allen M10	1	0	
HW5	H090030005	Clé Allen M8	1	0	

Country of Origin: China

Pais d'origine: Chine

1

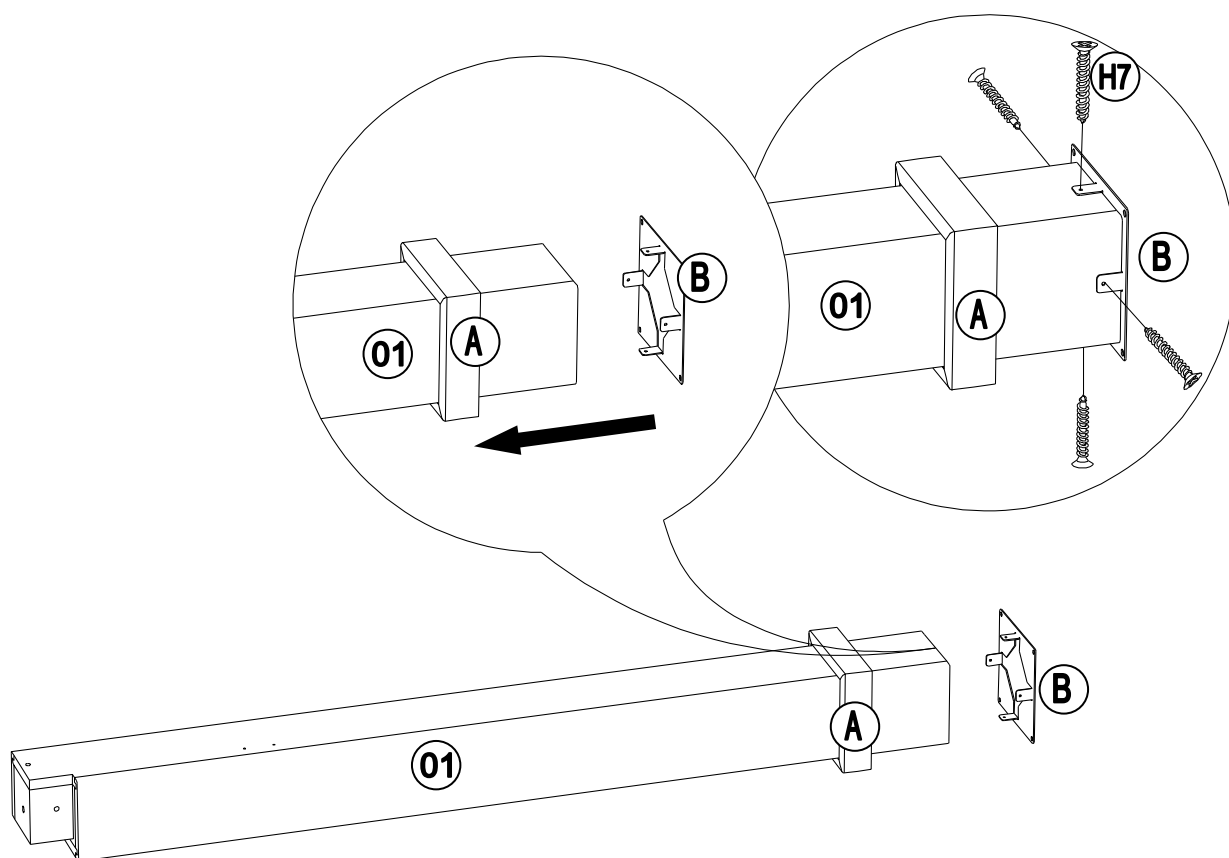
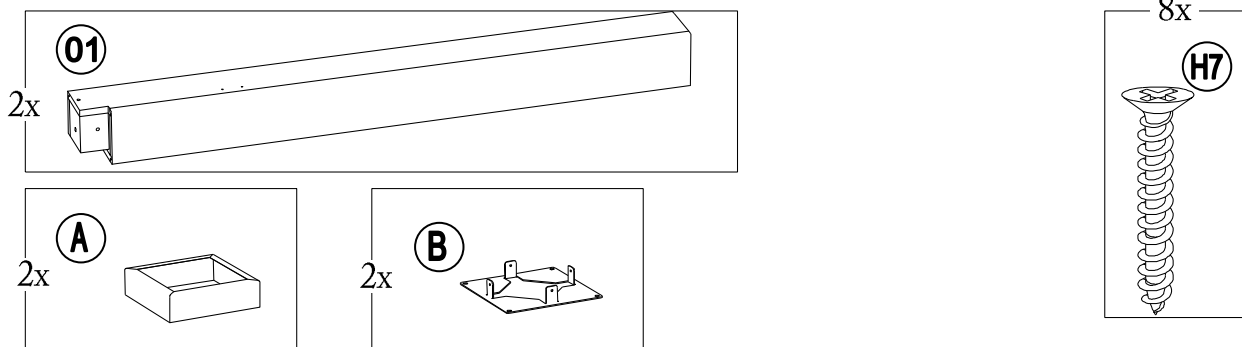

2

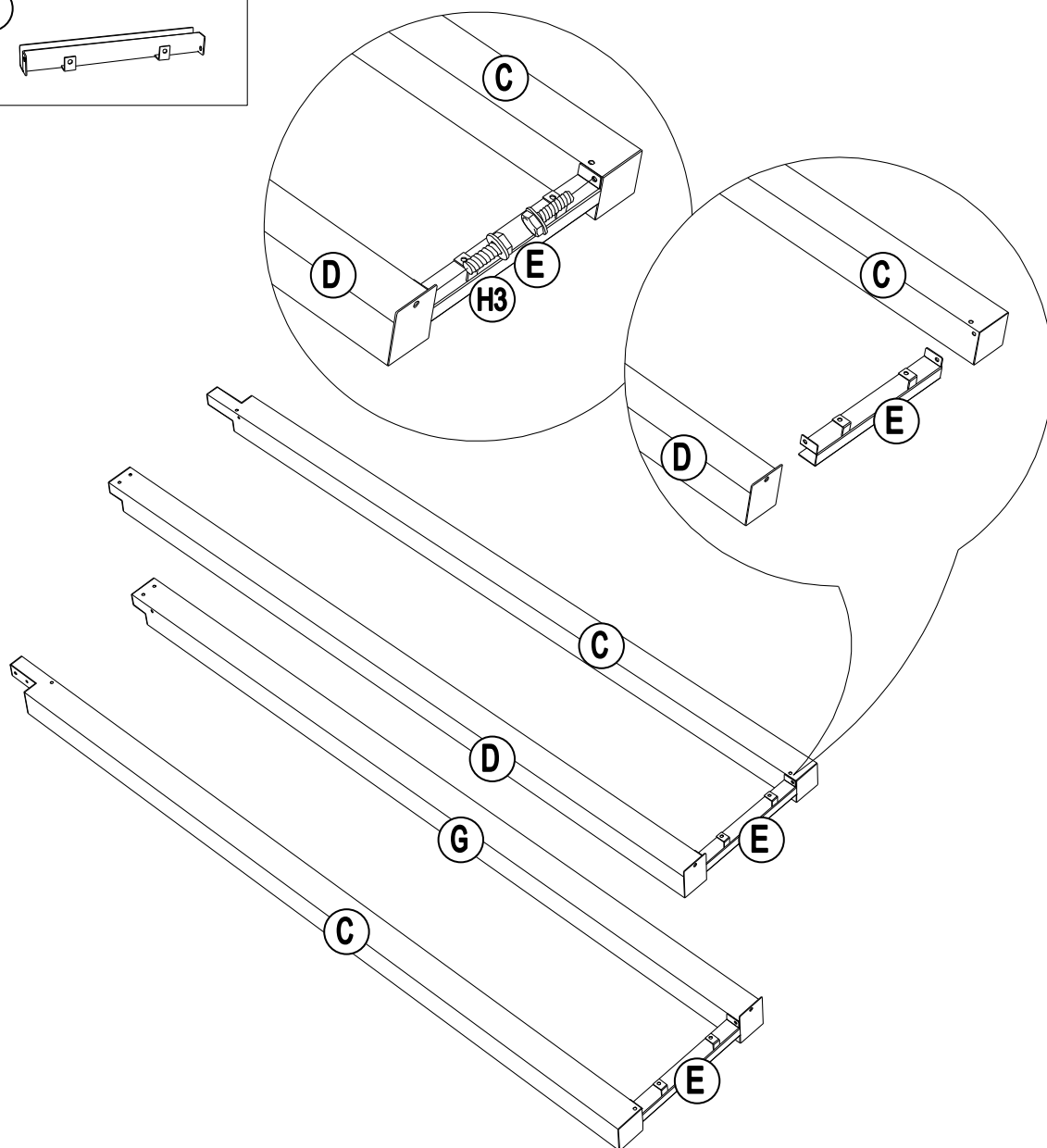
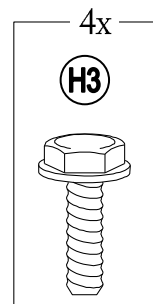
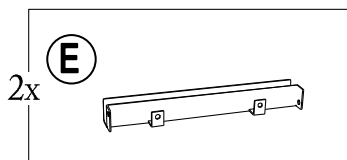
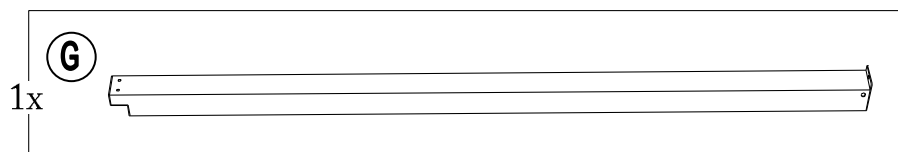
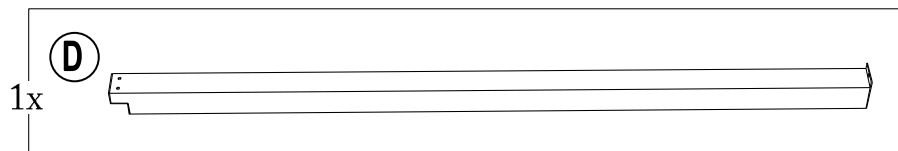
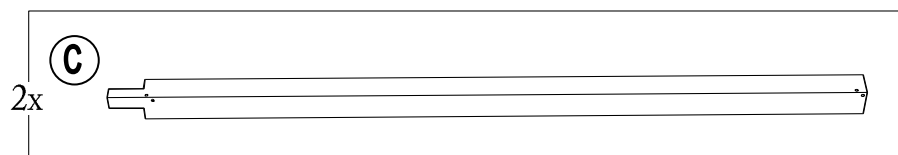

Country of Origin: China
 Pais d'origine: Chine

3

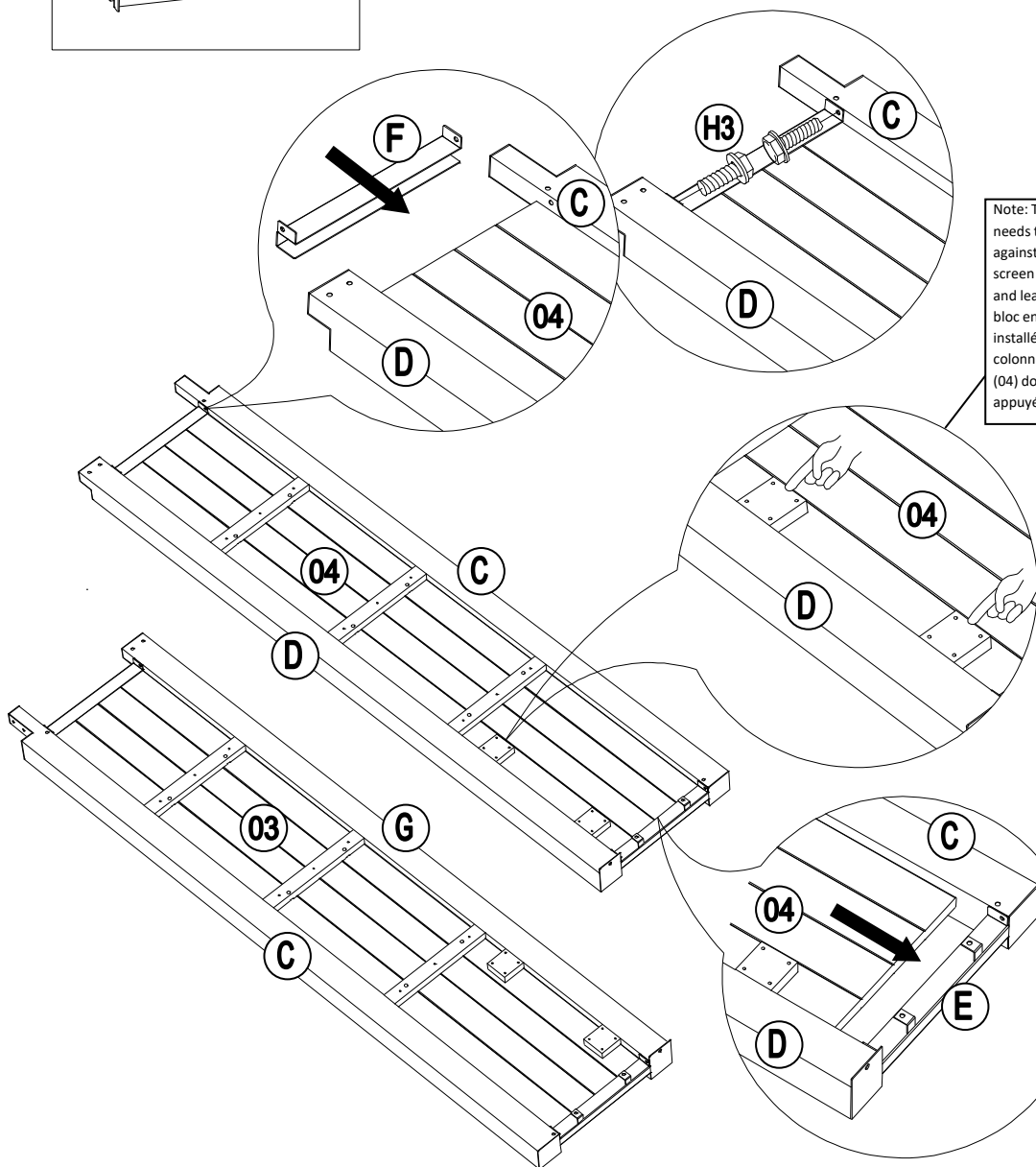
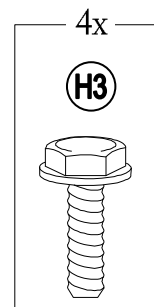
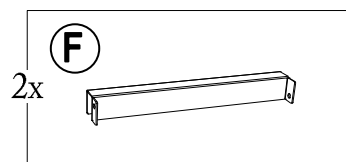
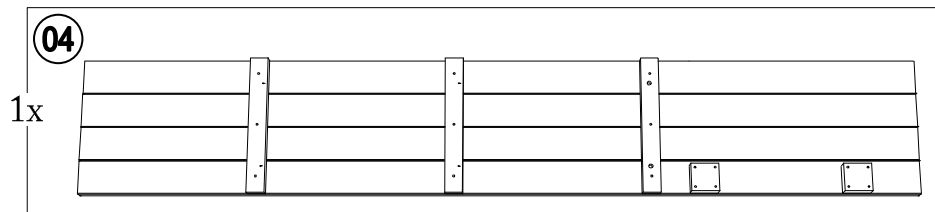
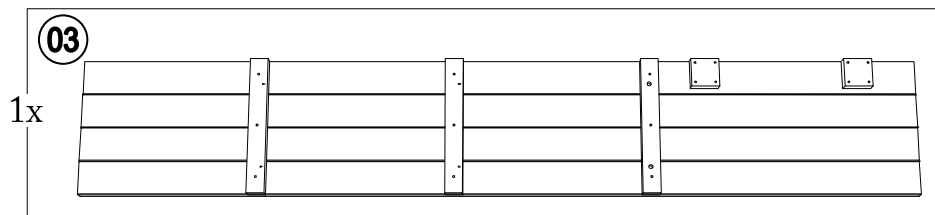

Note: The wooden block on vertical screen 2 (03) needs to be installed at the lower end and leaning against column 2 (D); the wooden block on vertical screen 3 (04) needs to be installed at the lower end and leaning against column 3 (G)/Remarque : Le bloc en bois sur l'écran vertical 2 (03) doit être installé à l'extrémité inférieure et appuyé contre la colonne 2 (D) ; le bloc de bois sur l'écran vertical 3 (04) doit être installé à l'extrémité inférieure et appuyé contre la colonne 3 (G)

4

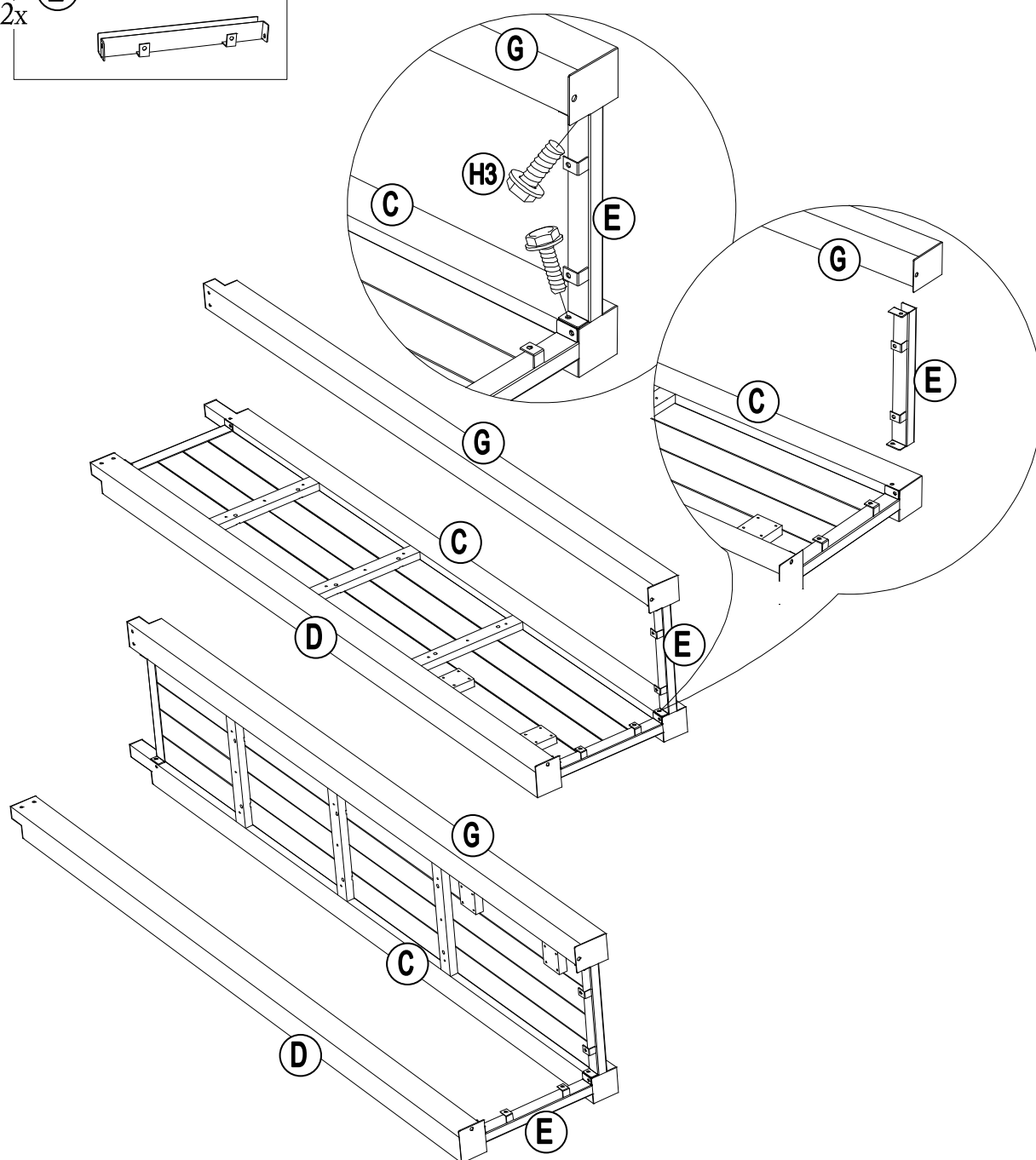
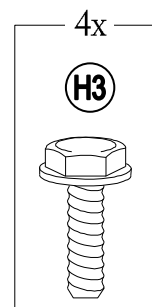
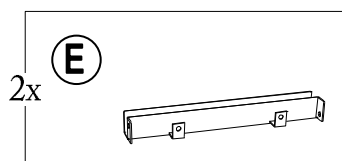
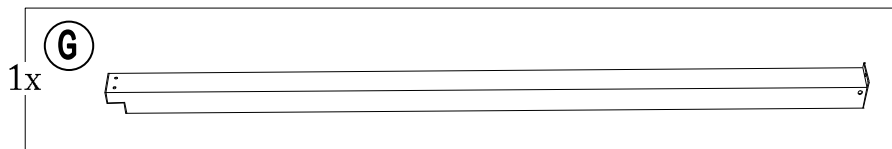
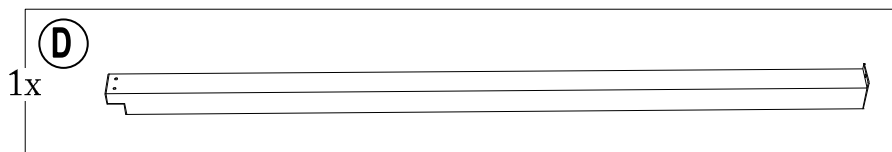

Country of Origin: China
 Pays d'origine: Chine

5

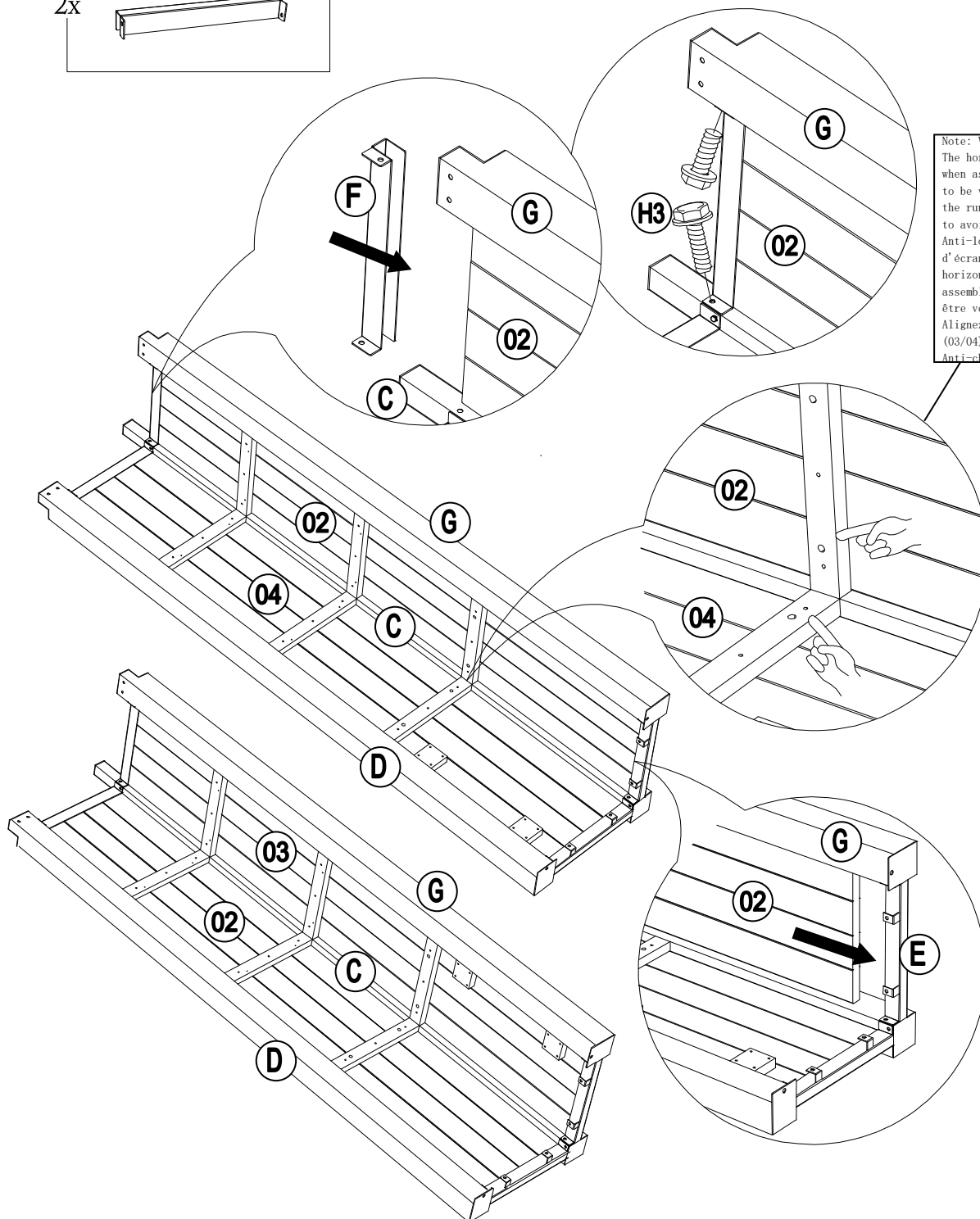
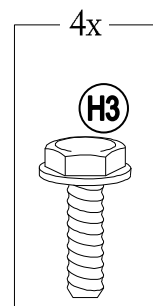
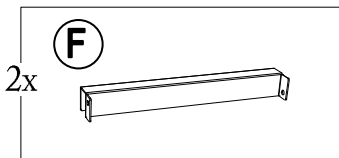
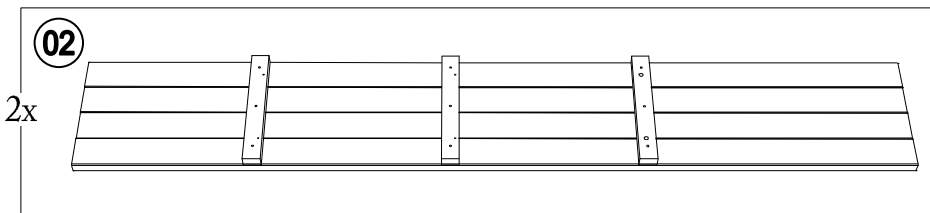

Note: Vertical screen piece 1 (02)
 The horizontal part of the screen
 when assembled The stall tube needs
 to be vertical to the screen Align
 the rungs on the sheet 2/3 (03/04)
 to avoid
 Anti-loaded./Remarque : Pièce
 d'écran vertical 1 (02) La partie
 horizontale de l'écran une fois
 assemblé Le tube de décrochage doit
 être vertical par rapport à l'écran
 Alignez les barreaux sur la tôle 2/3
 (03/04) pour éviter
 Anti-charge.

6

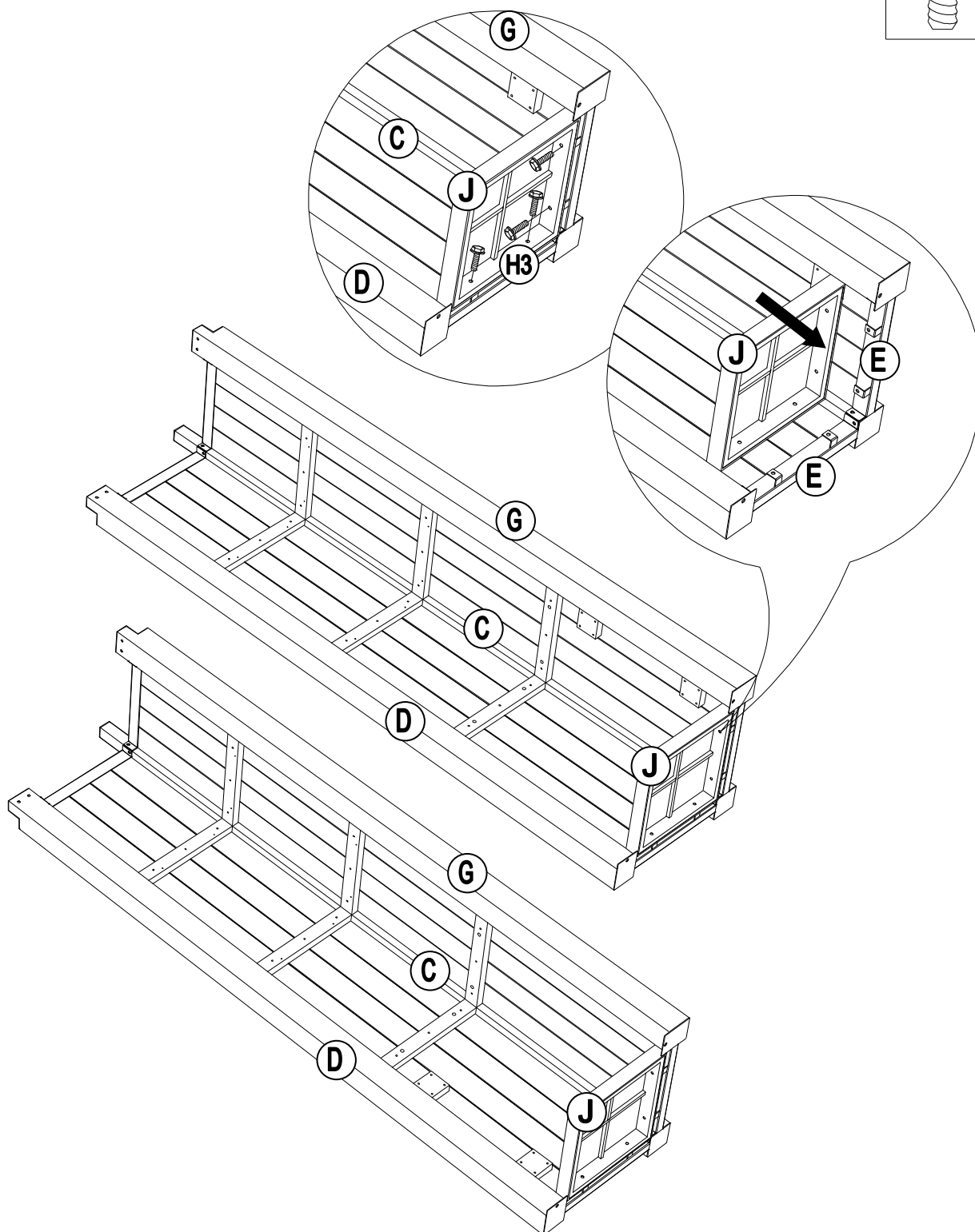
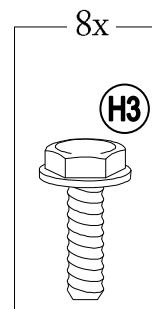
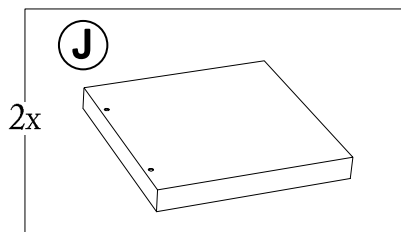

Country of Origin: China
Pais d'origine: Chine

7

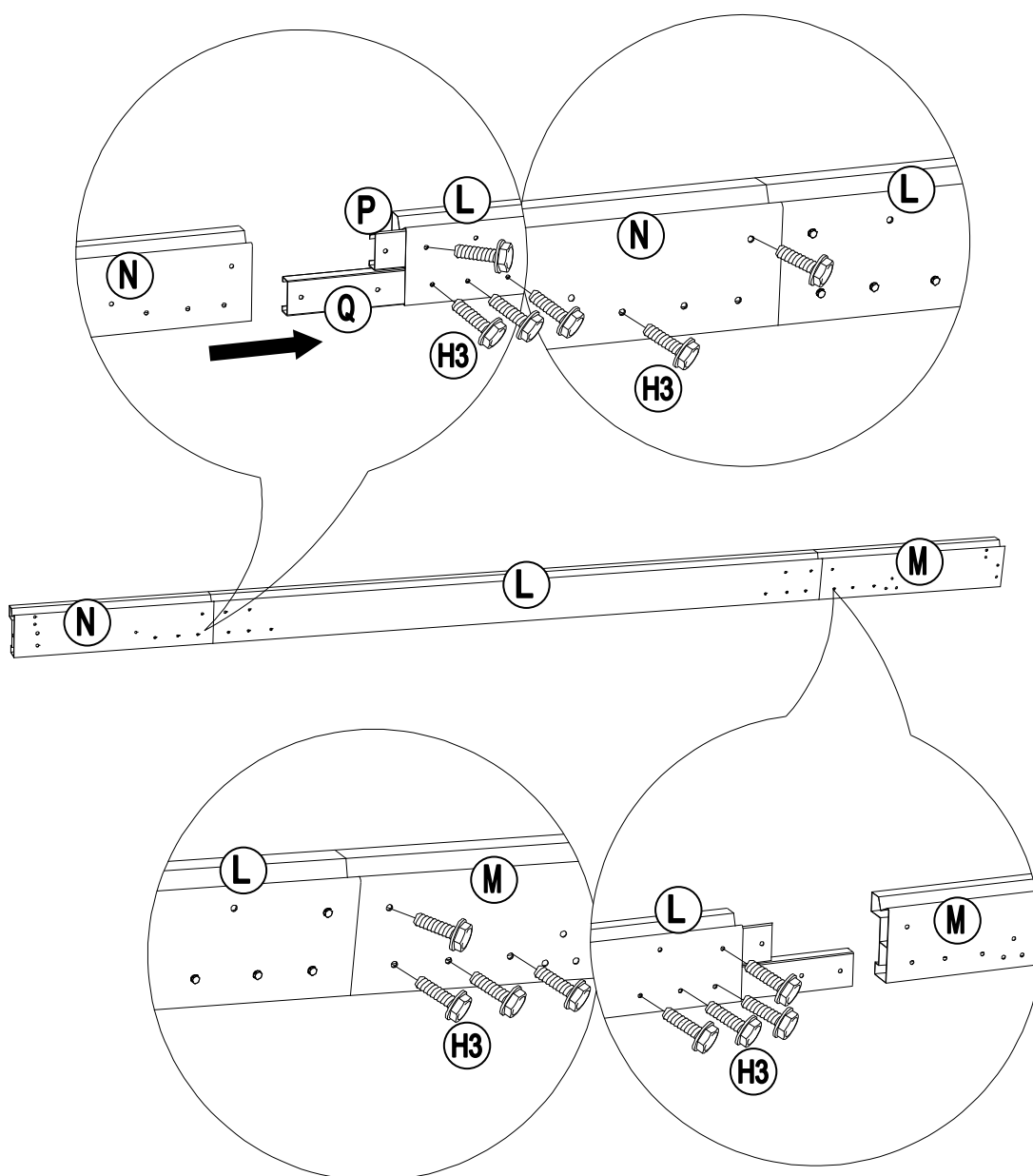
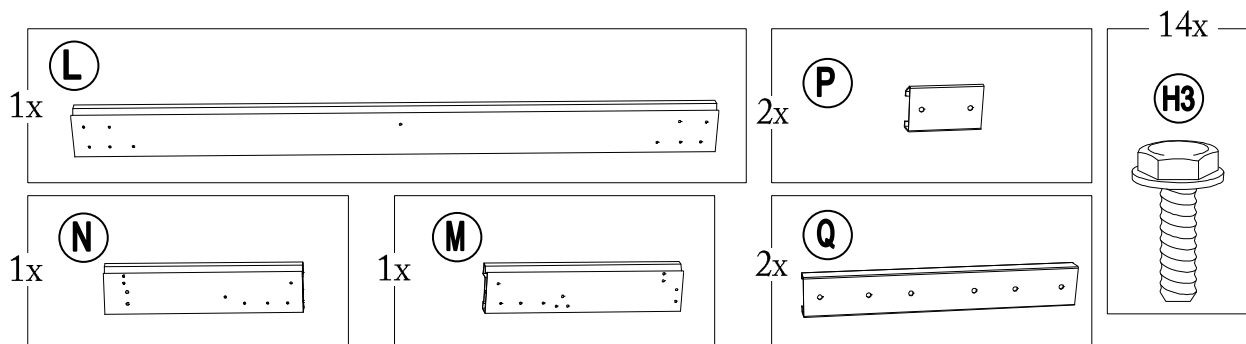

Country of Origin: China
 Pais d'origine: Chine

8

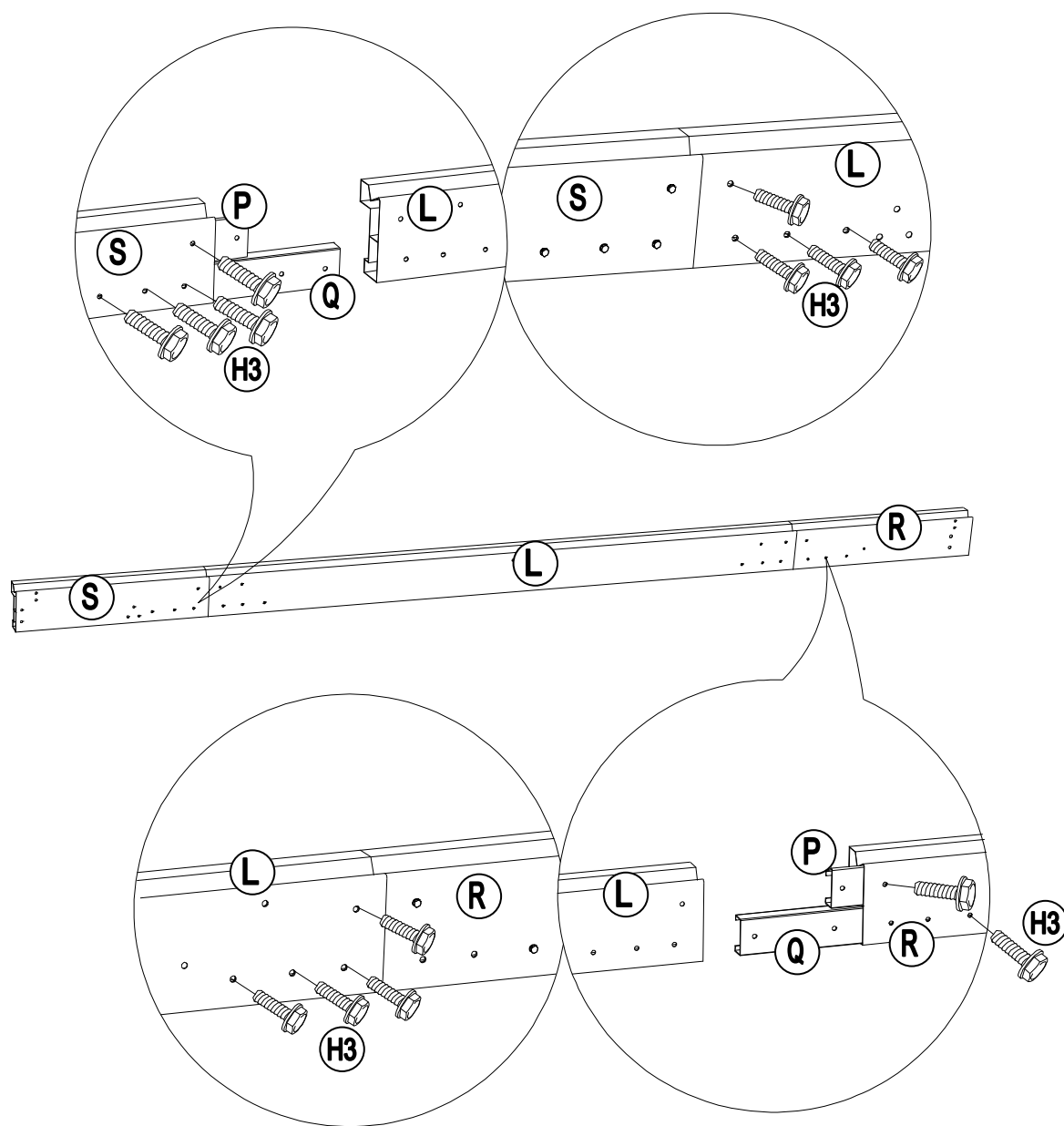
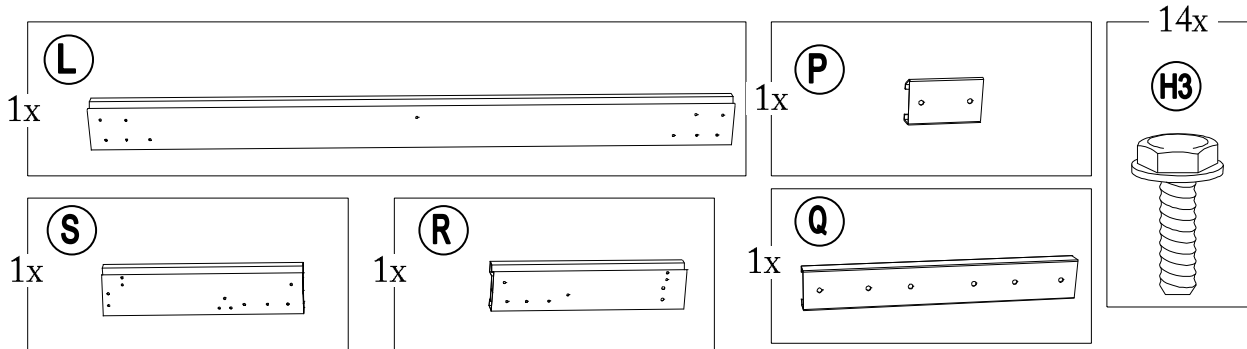

Country of Origin: China
Pais d'origine: Chine

9

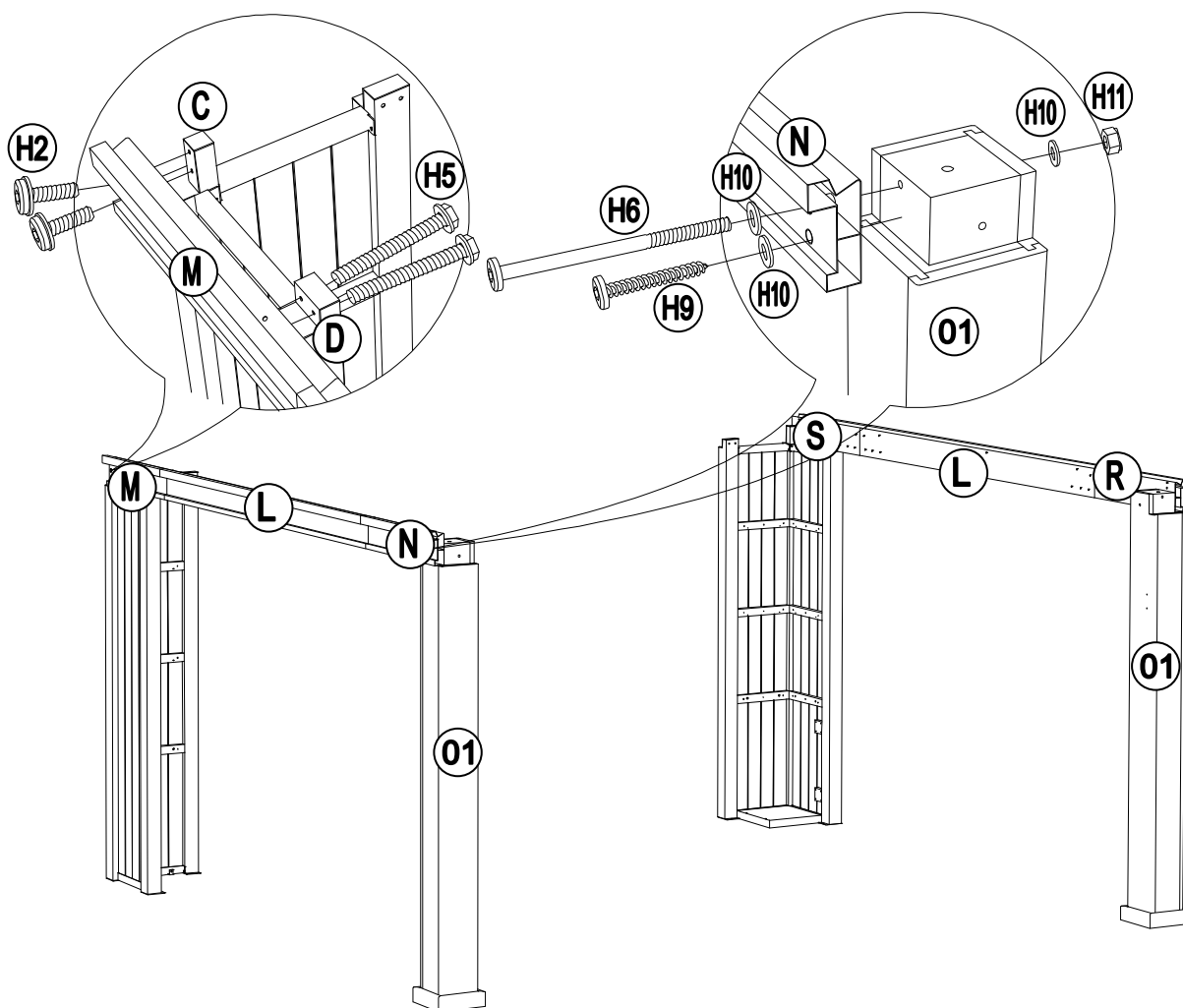
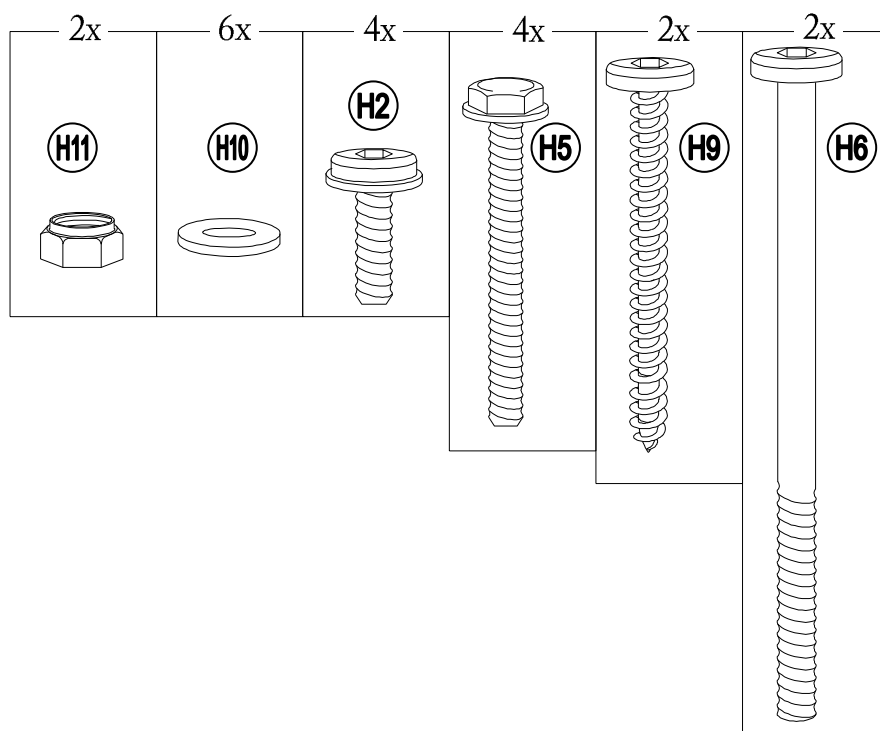

Country of Origin: China
 Pais d'origine: Chine

10

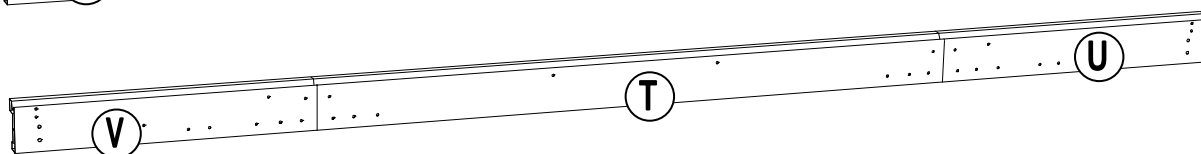
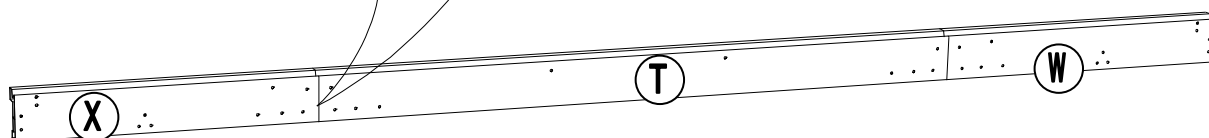
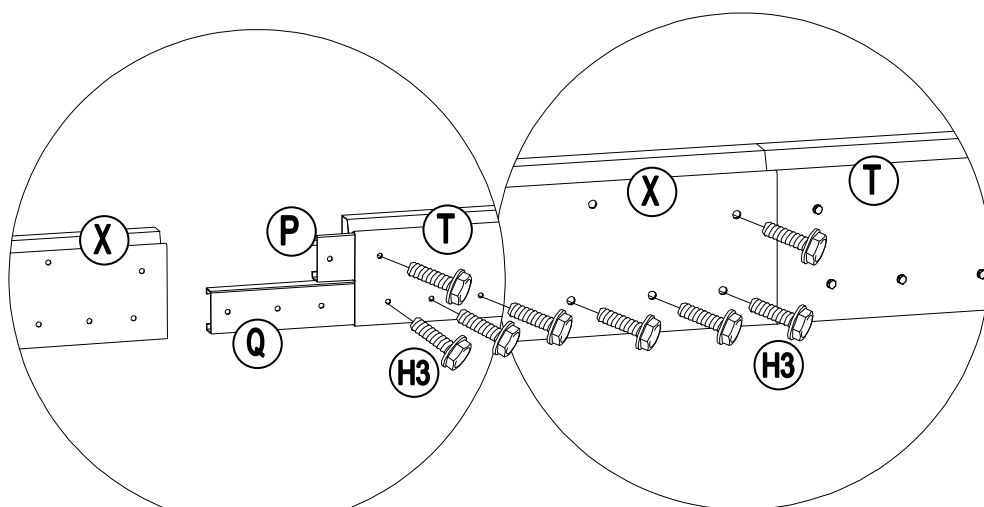
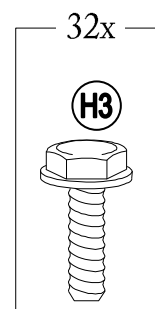
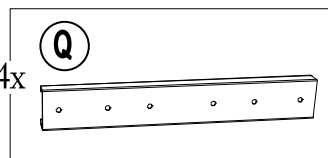
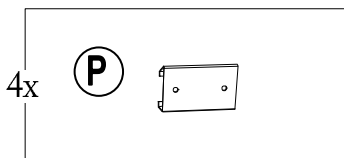
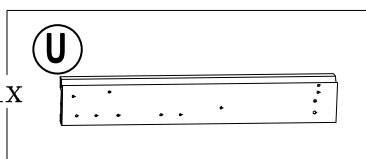
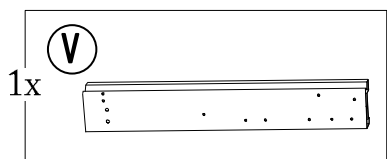
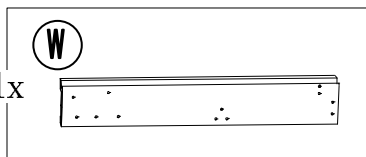
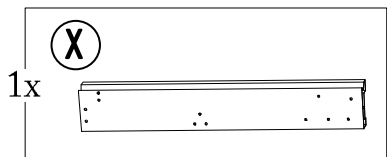
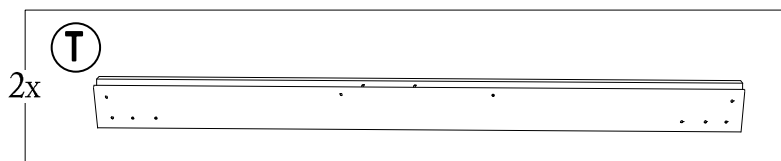

11

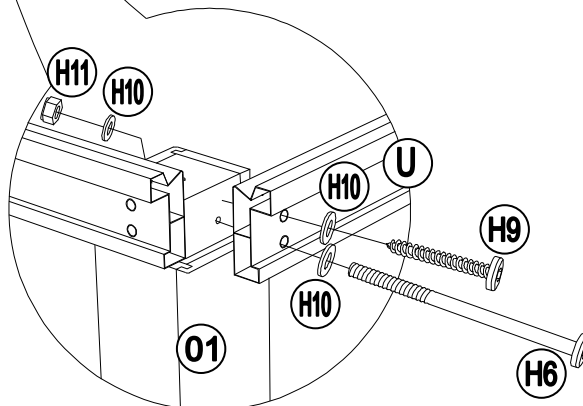
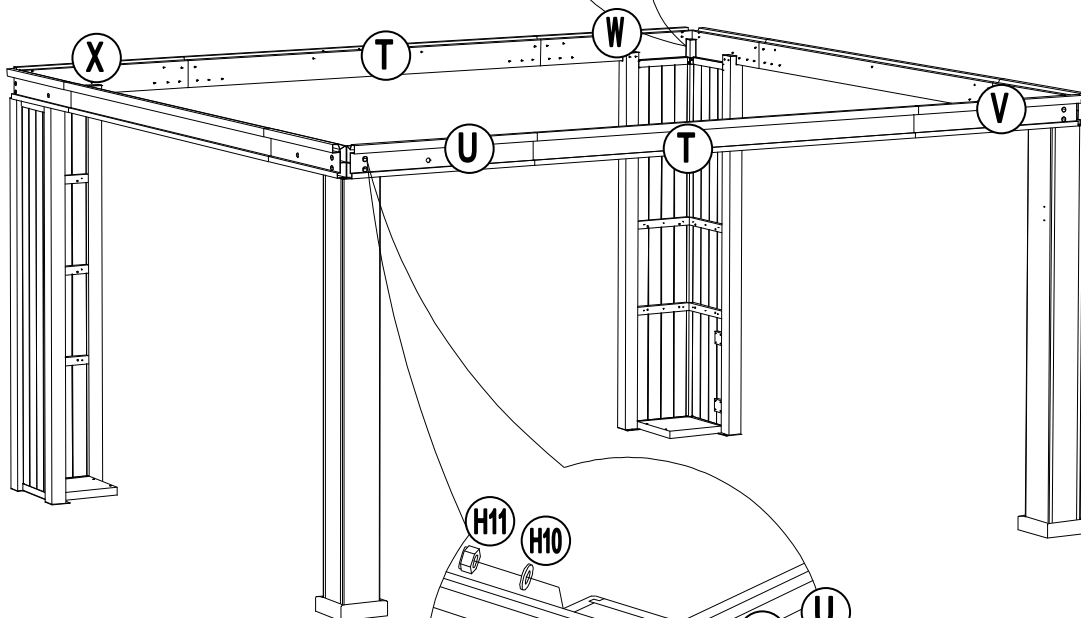
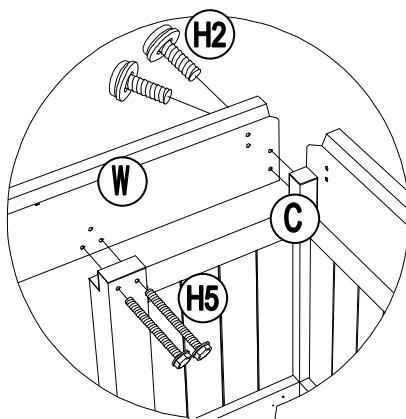
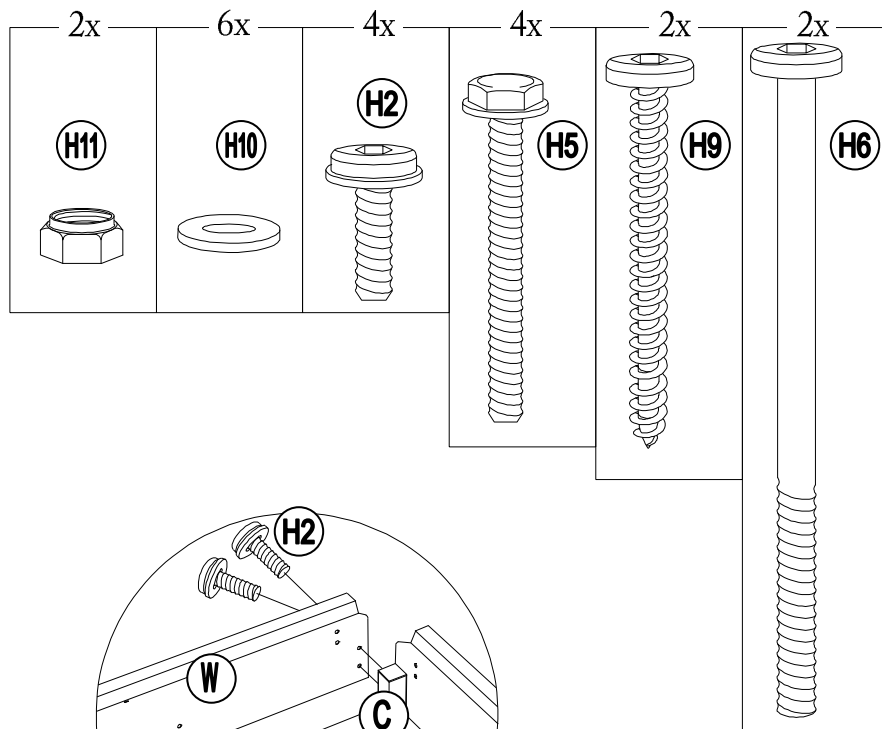

Country of Origin: China
 Pais d'origine: Chine

12

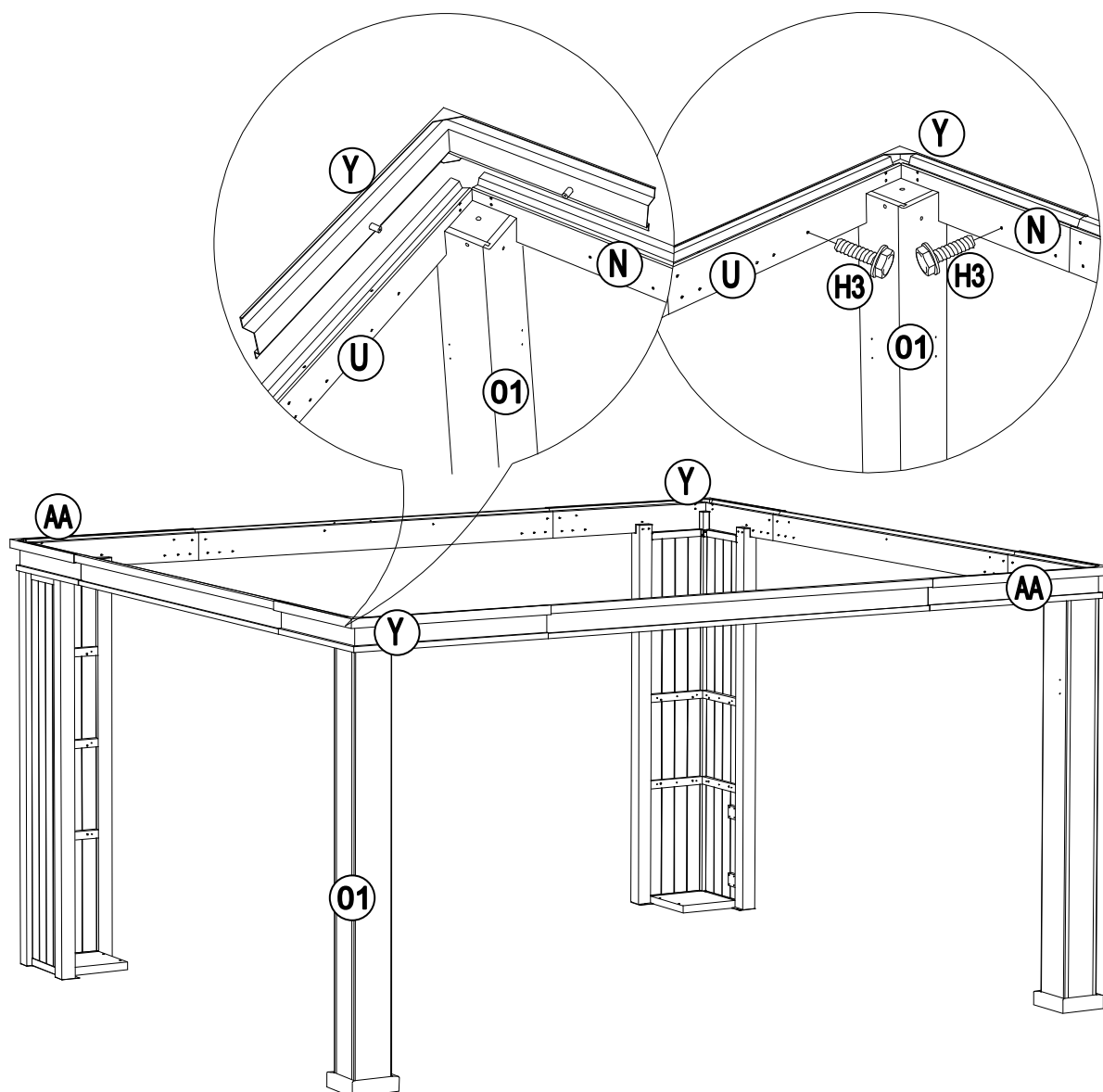
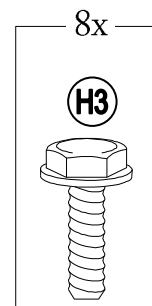
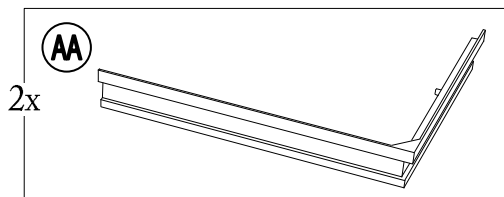
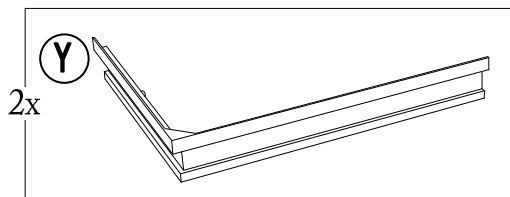

Country of Origin: China
 Pais d'origine: Chine

13

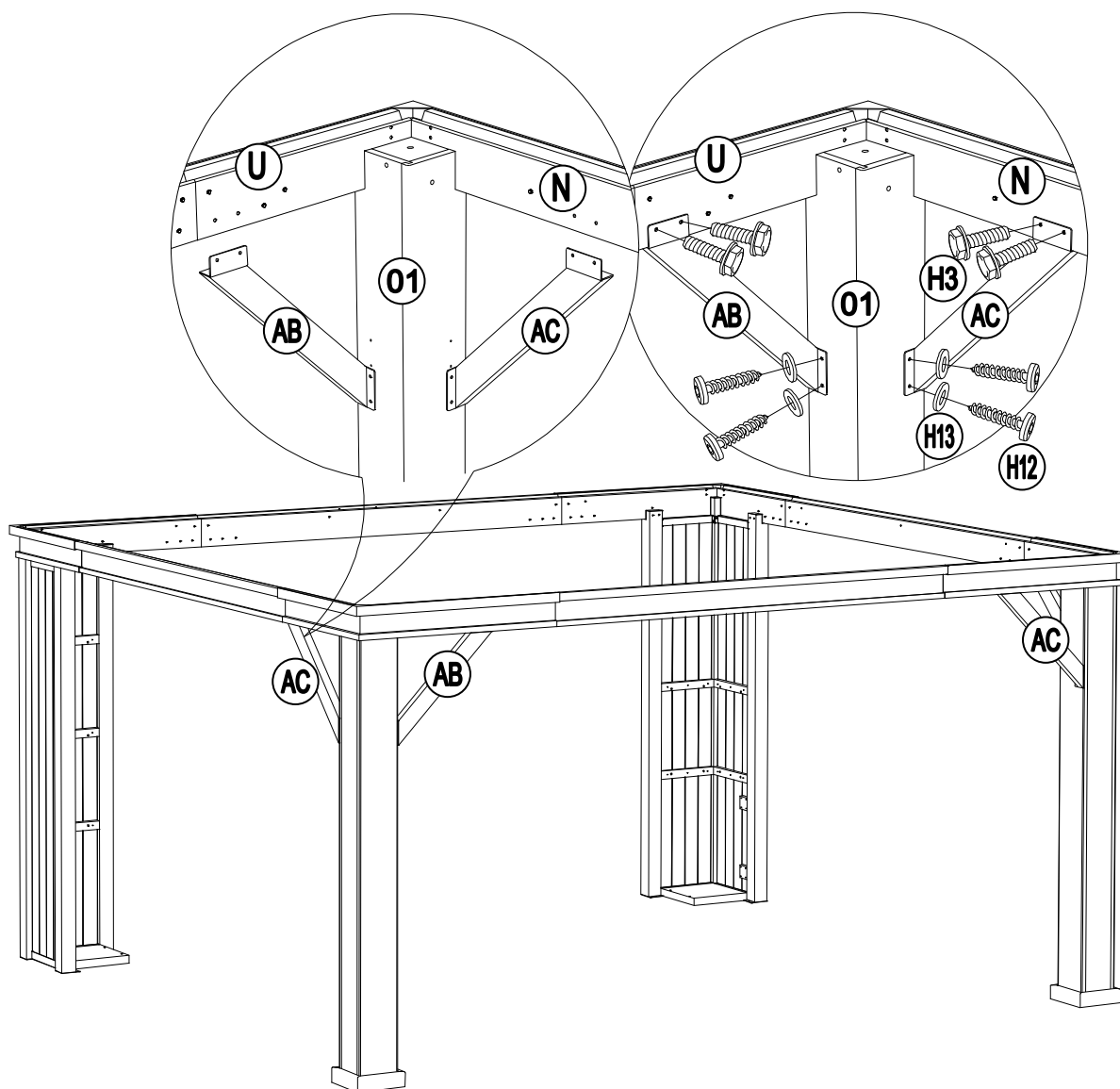
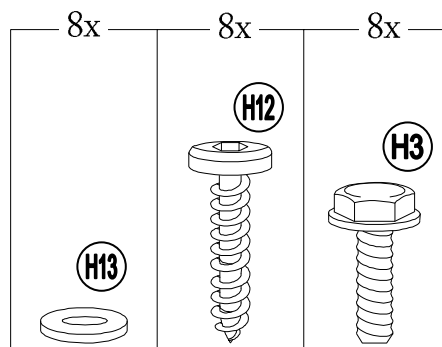
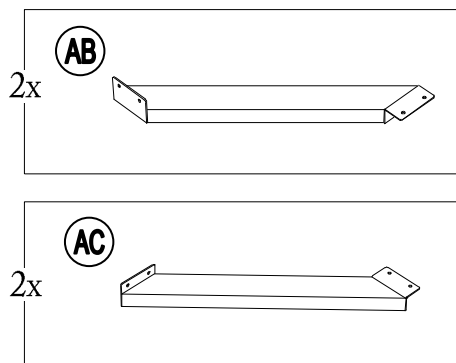

Country of Origin: China
 Pais d'origine: Chine

14

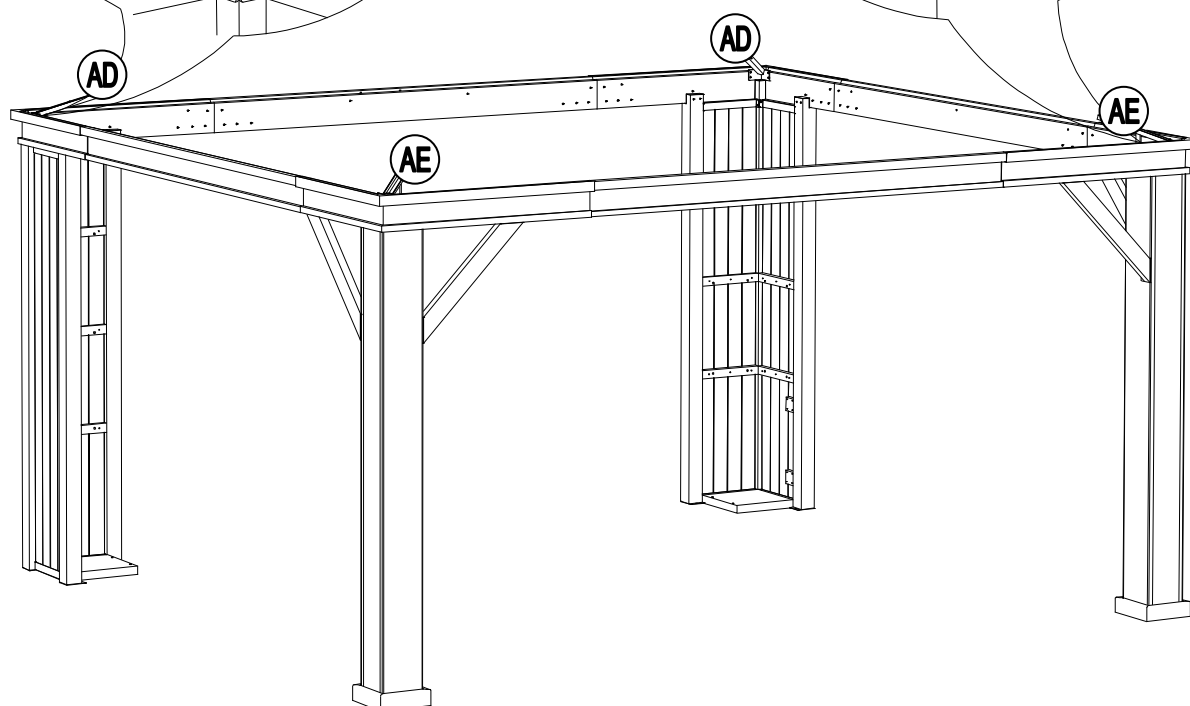
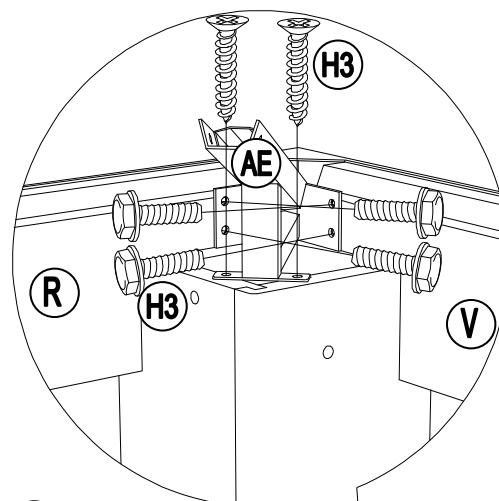
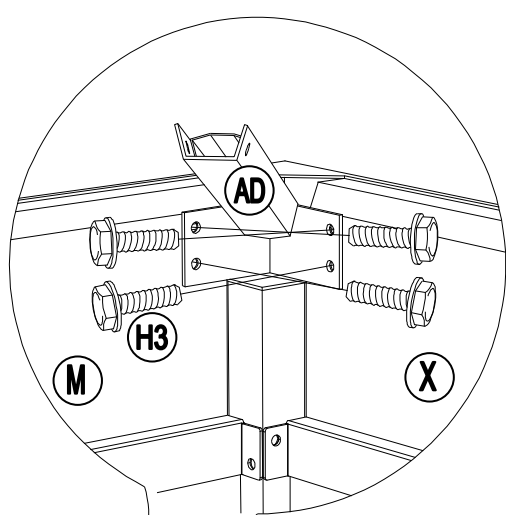
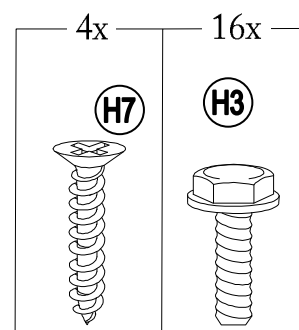
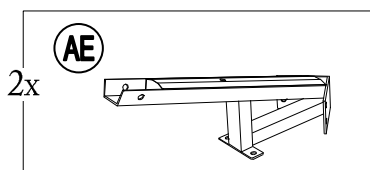
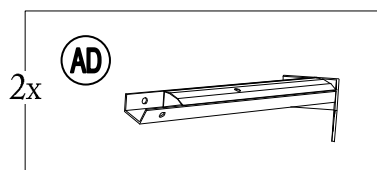

Country of Origin: China
Pais d'origine: Chine

15

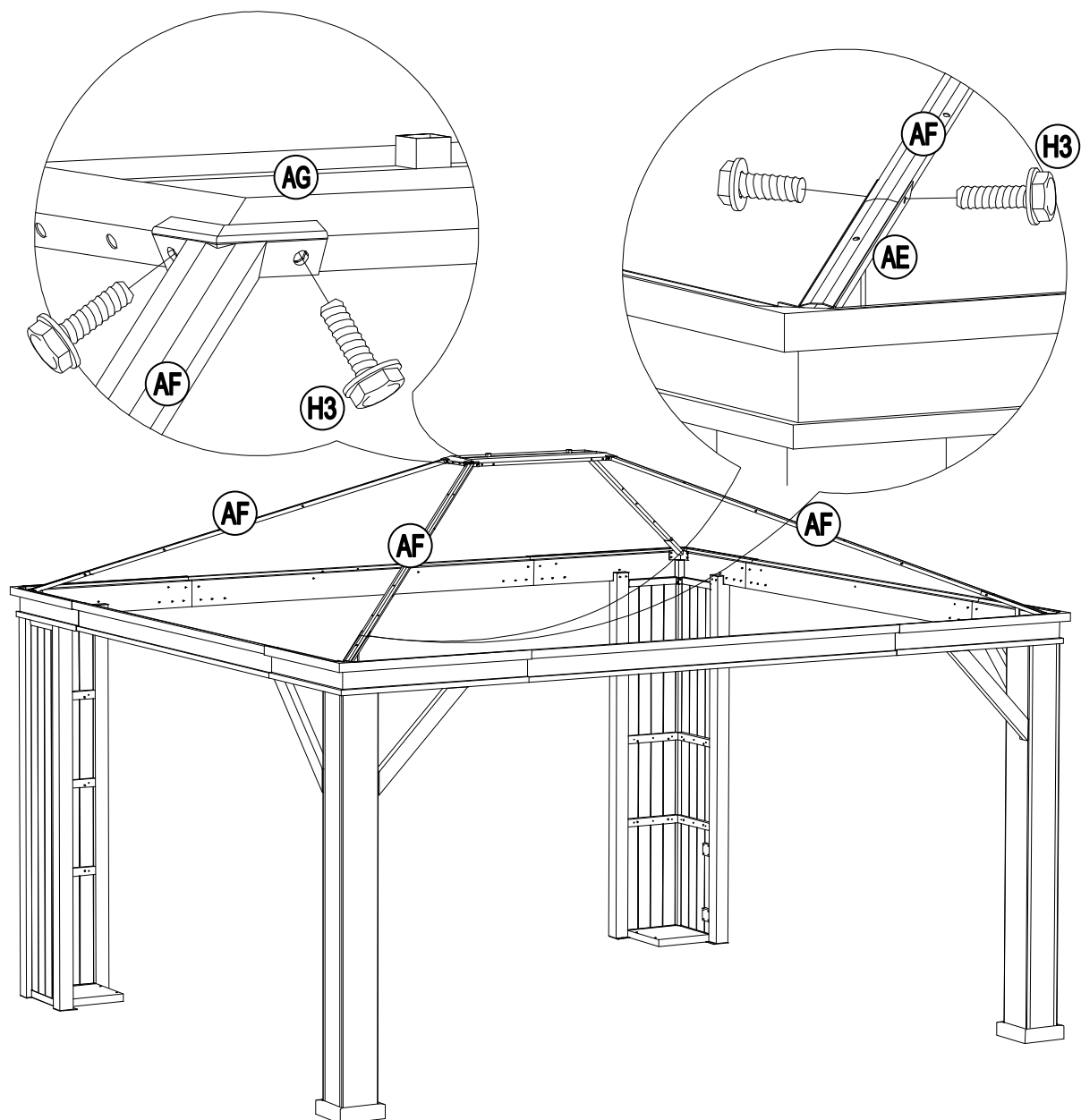
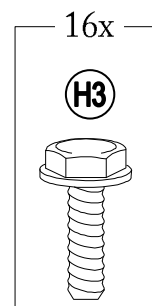
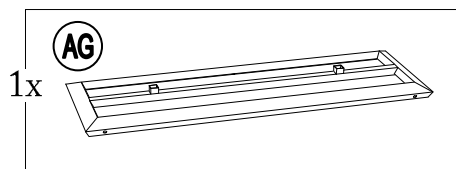
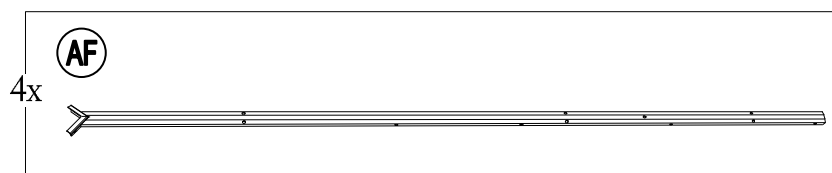

Country of Origin: China
Pais d'origine: Chine

16

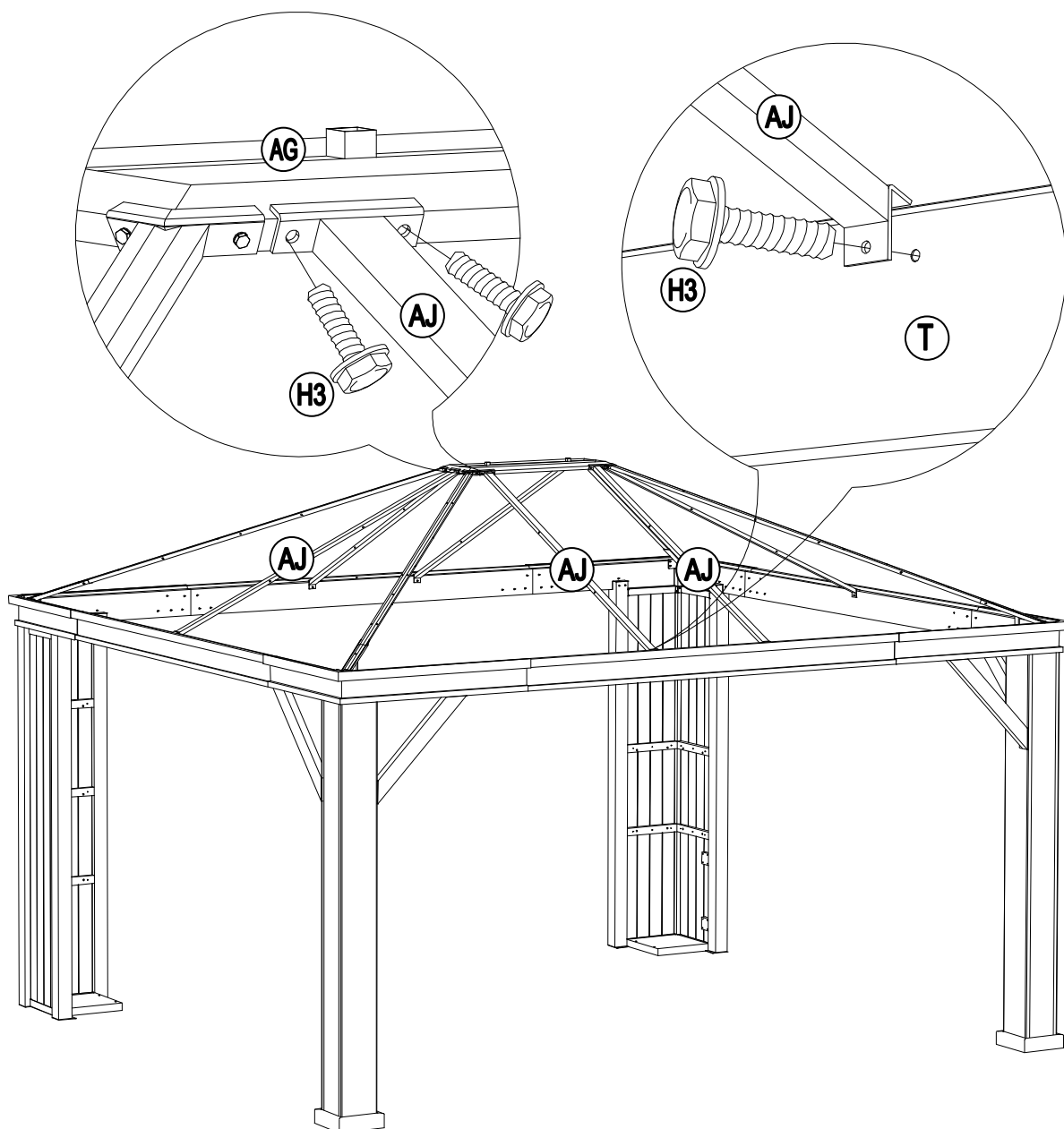
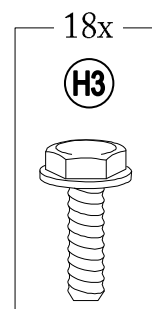
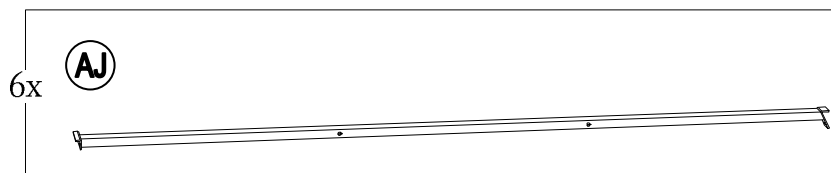

Country of Origin: China
Pais d'origine: Chine

17

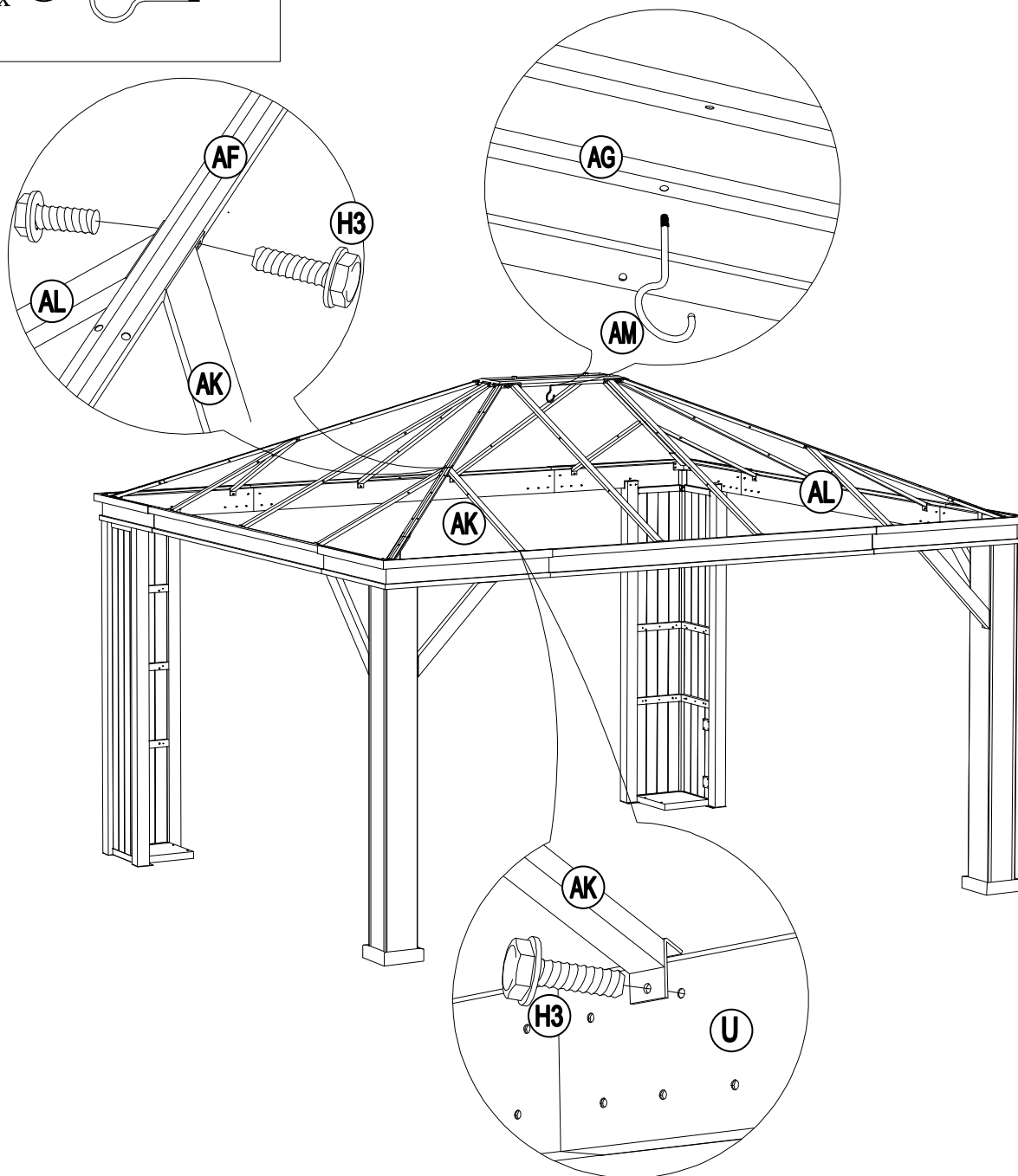
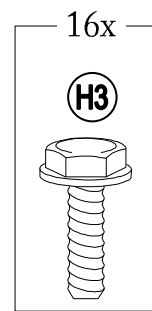
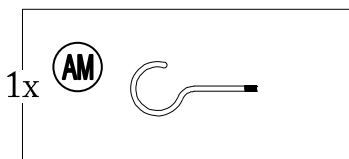
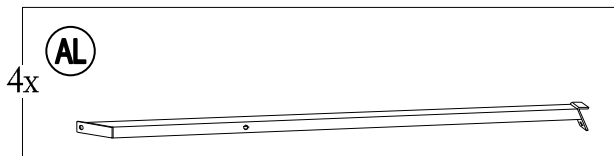
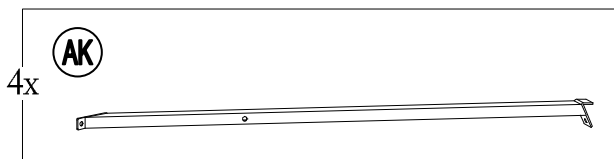

Country of Origin: China
Pais d'origine: Chine

18

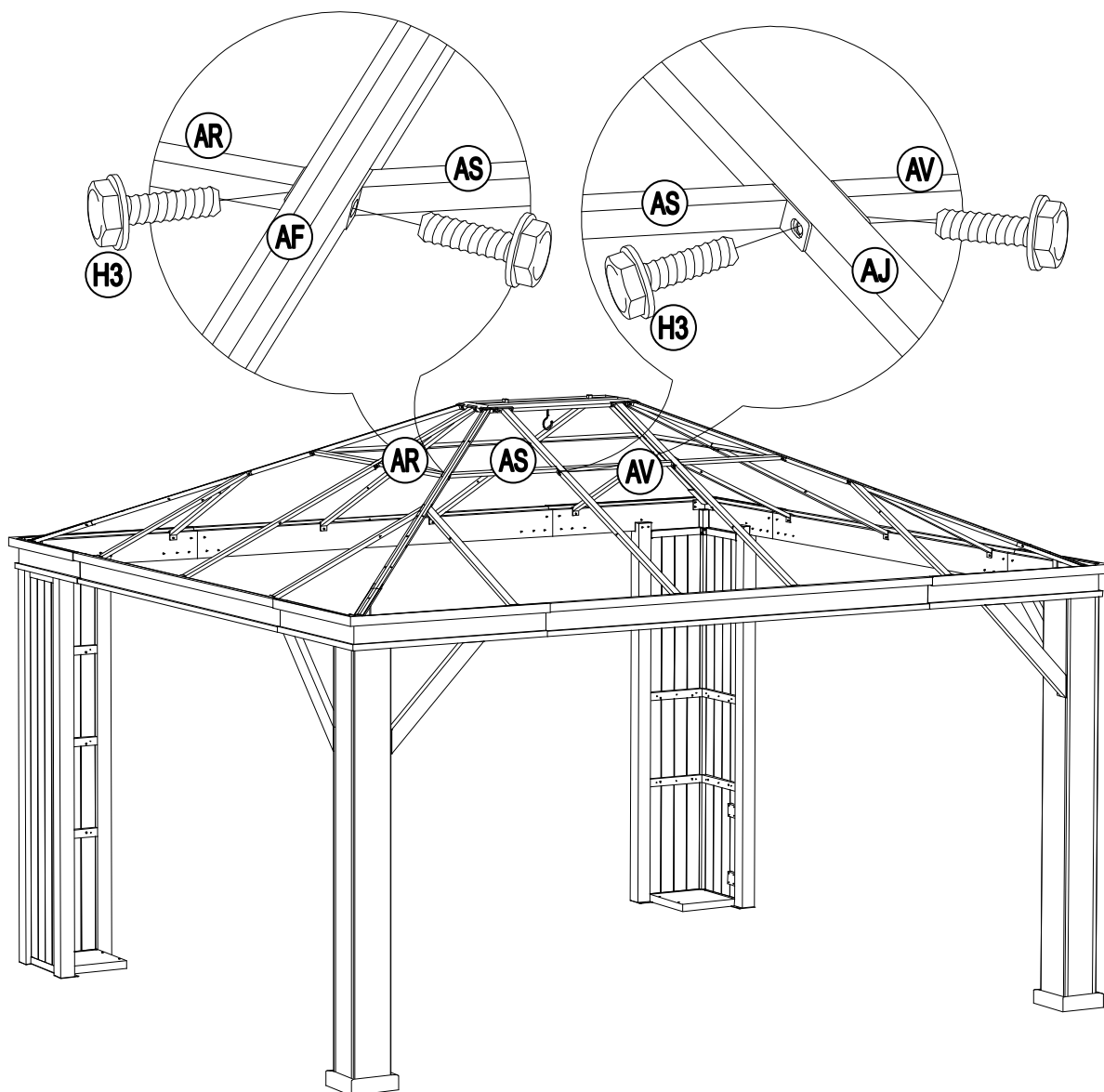
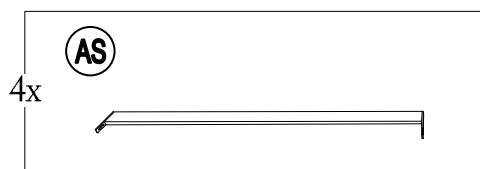
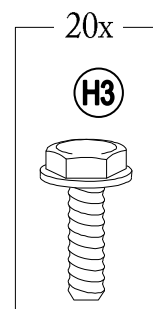
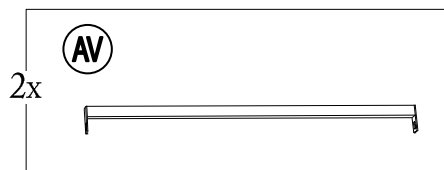
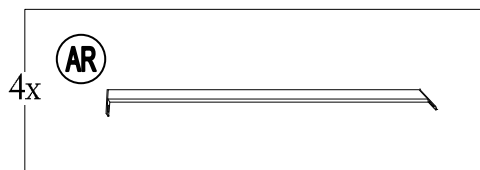

Country of Origin: China
Pais d'origine: Chine

19

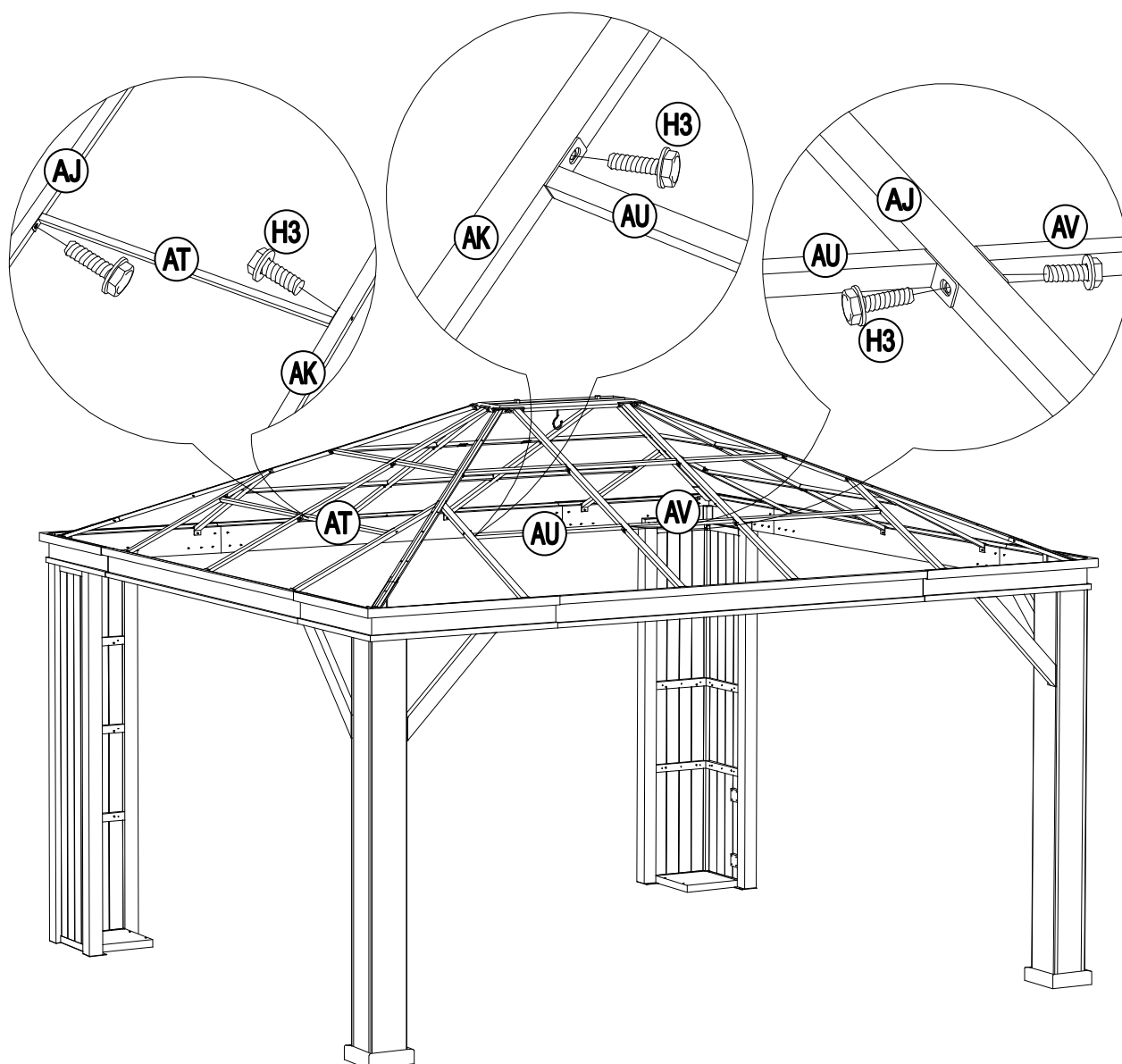
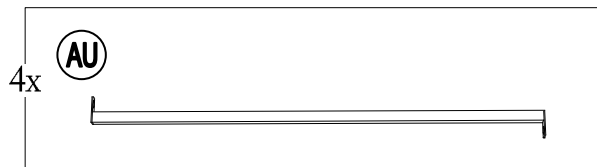
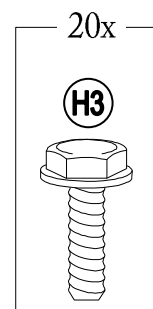
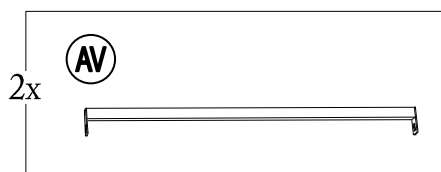
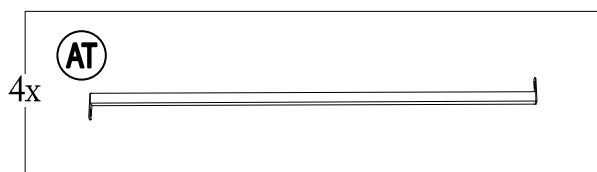

Country of Origin: China
 Pais d'origine: Chine

20

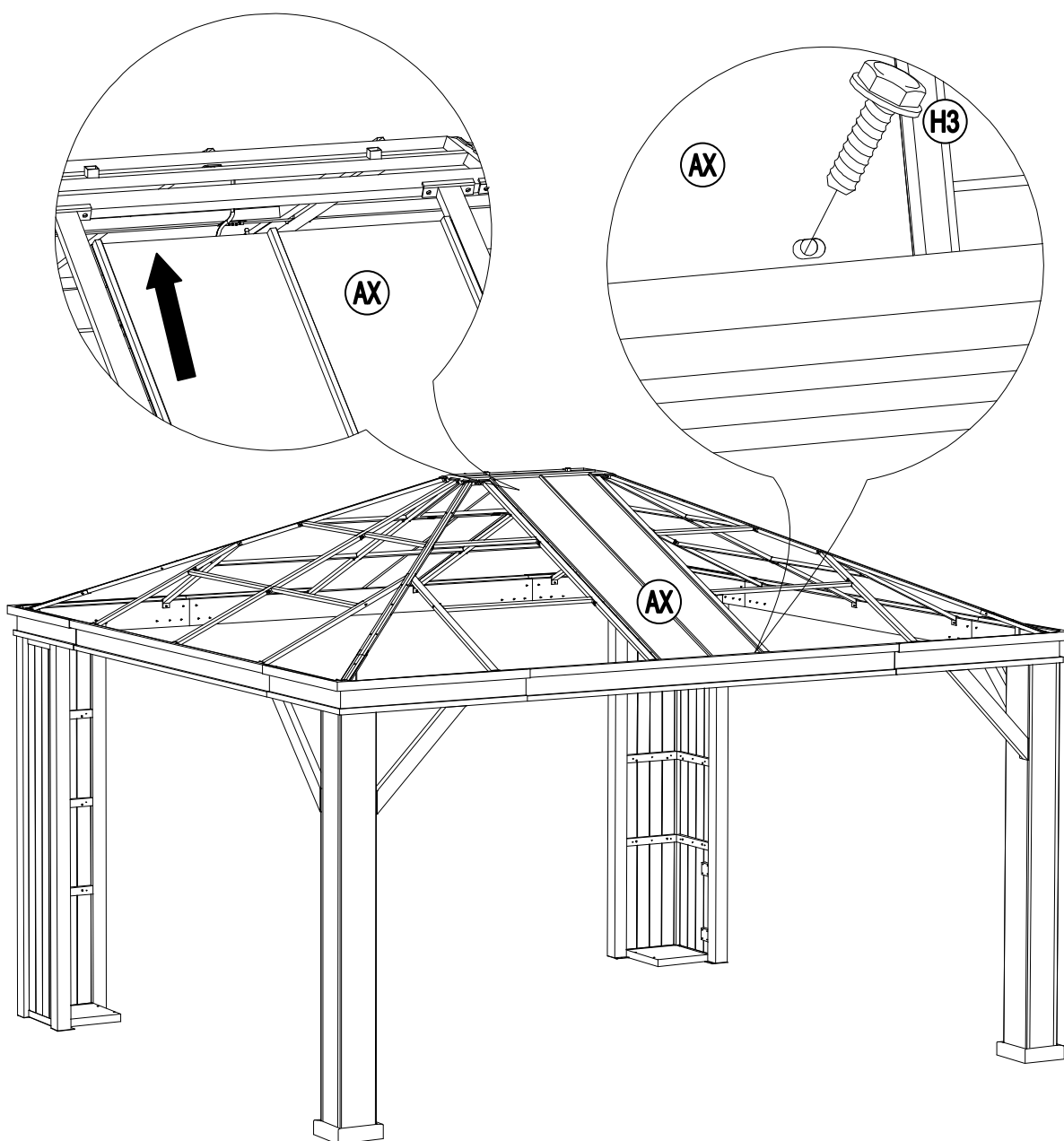
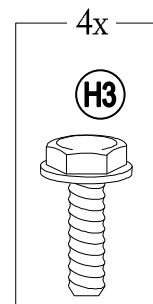
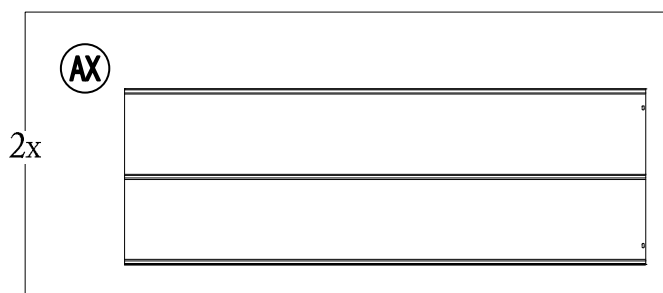

Country of Origin: China
Pais d'origine: Chine

21

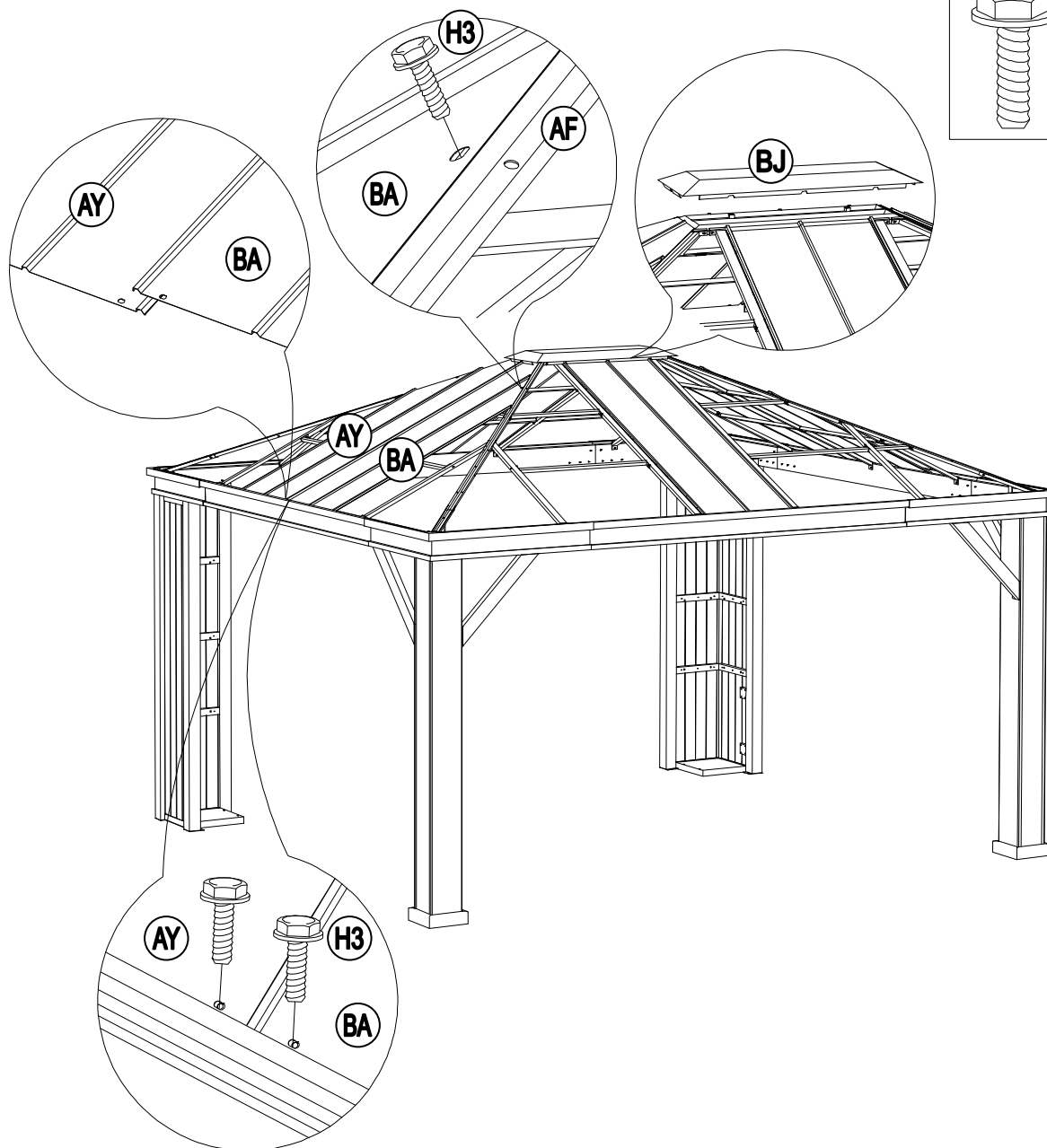
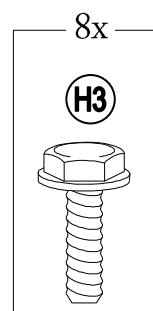
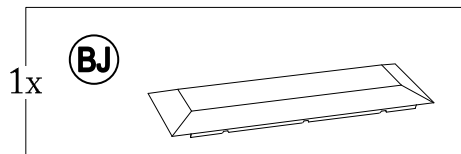
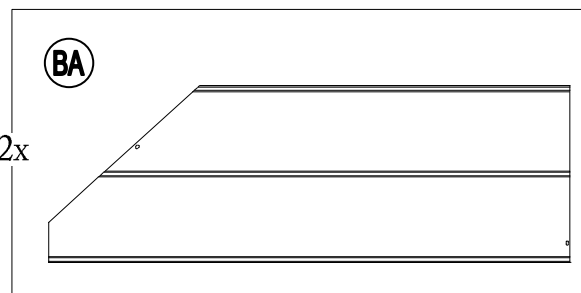
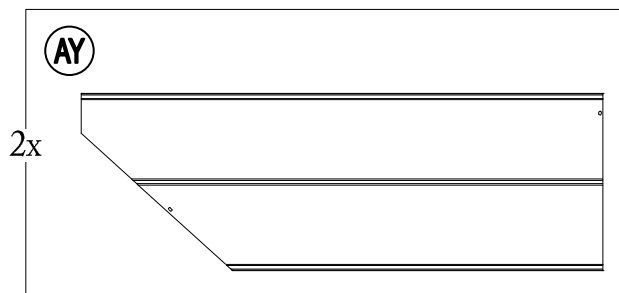

Country of Origin: China
Pais d'origine: Chine

22

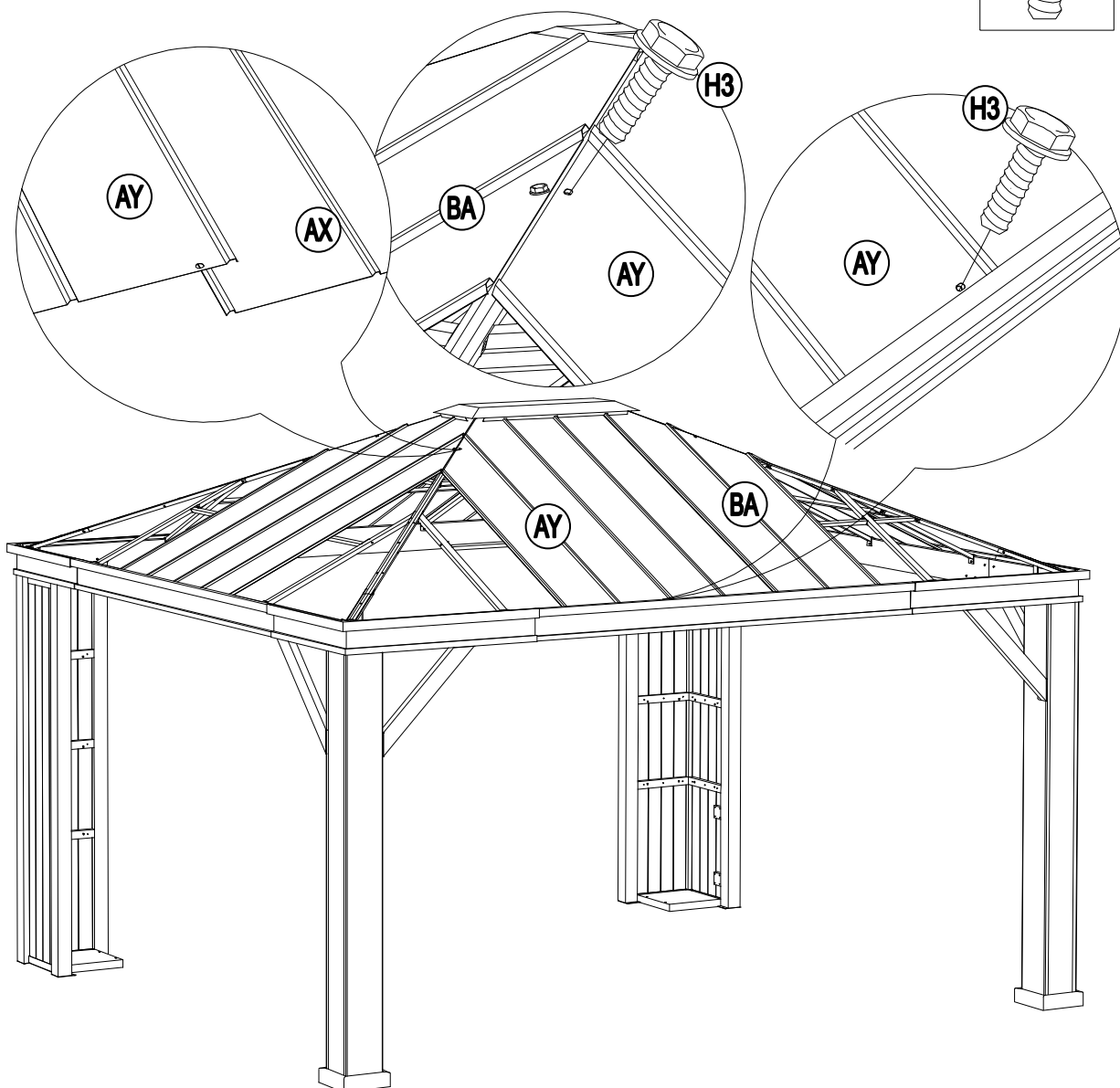
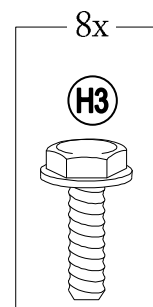
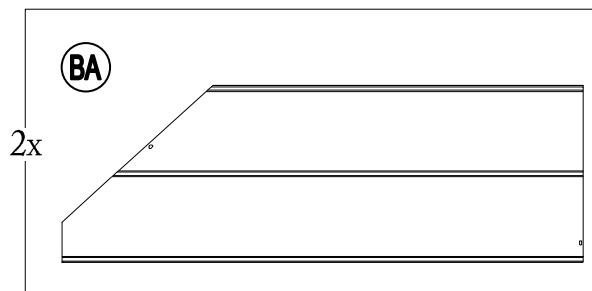
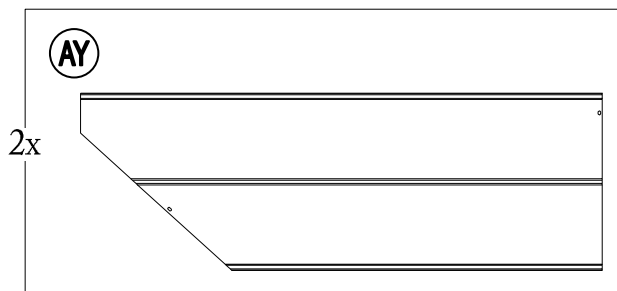

Country of Origin: China
Pais d'origine: Chine

23

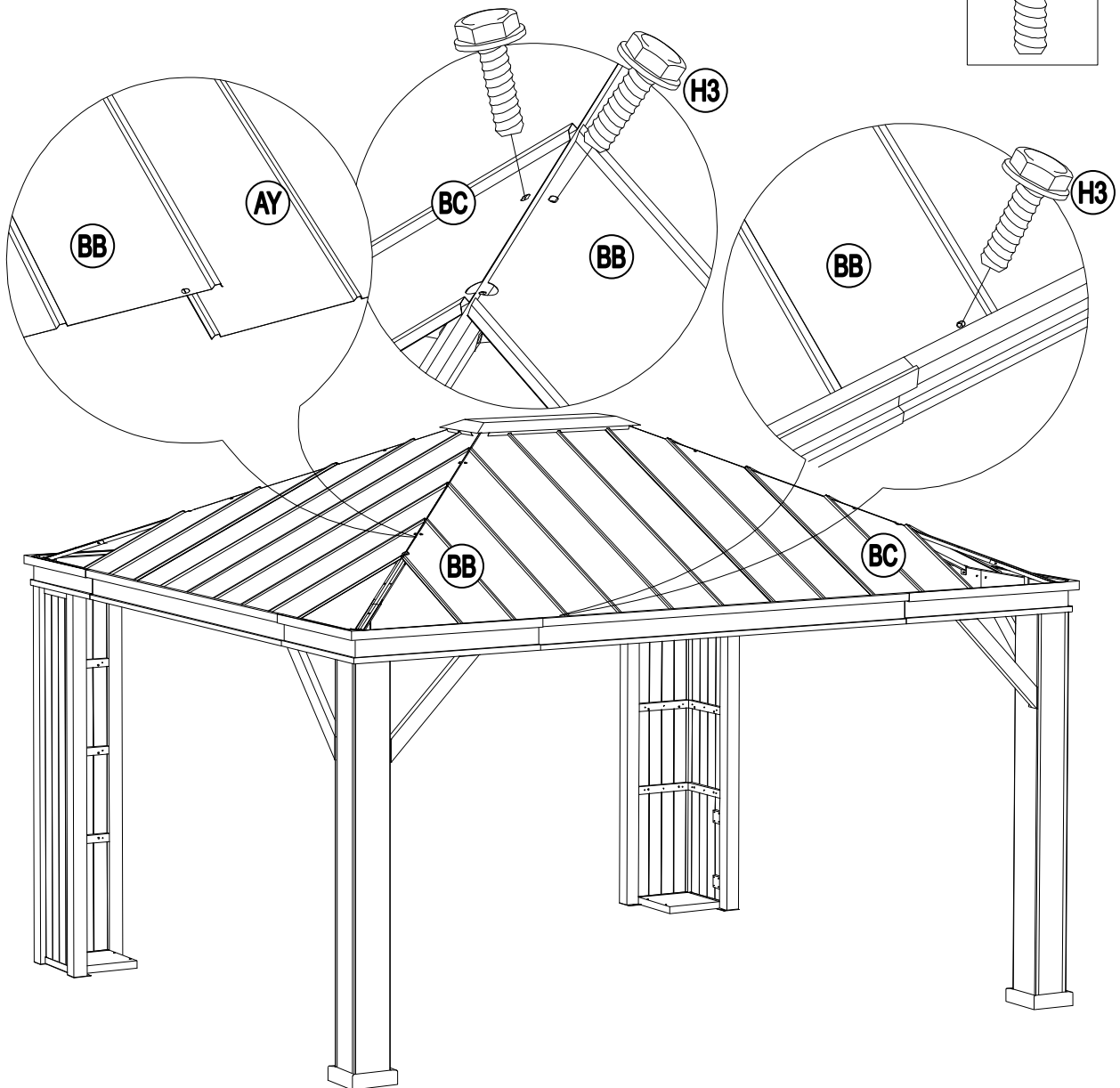
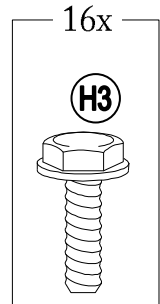
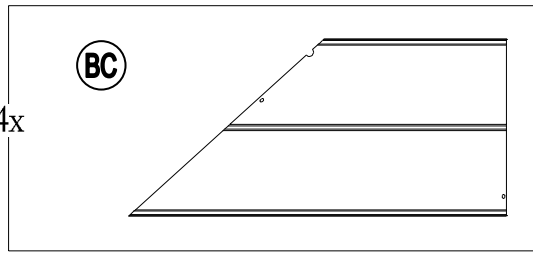
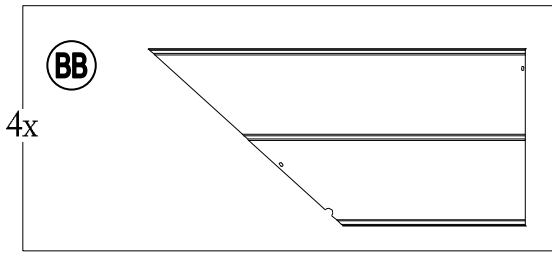

Country of Origin: China
Pais d'origine: Chine

24

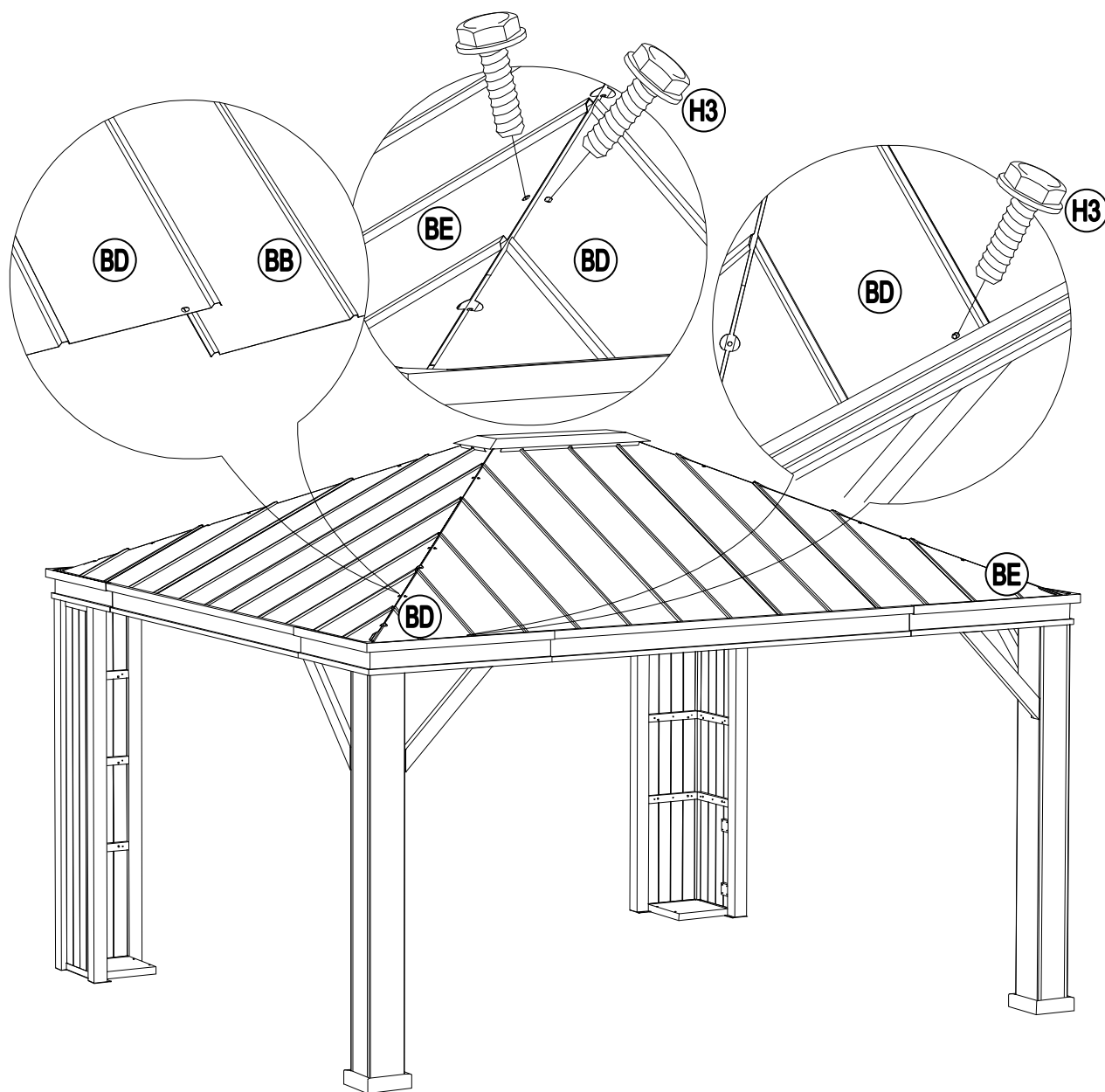
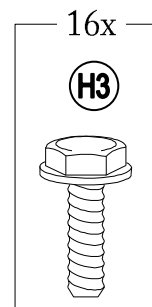
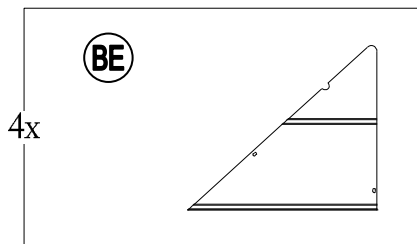
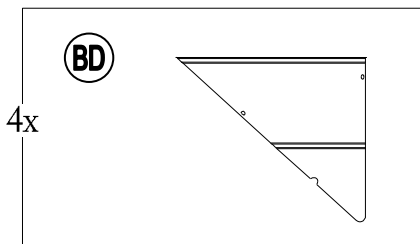

Country of Origin: China
Pais d'origine: Chine

25

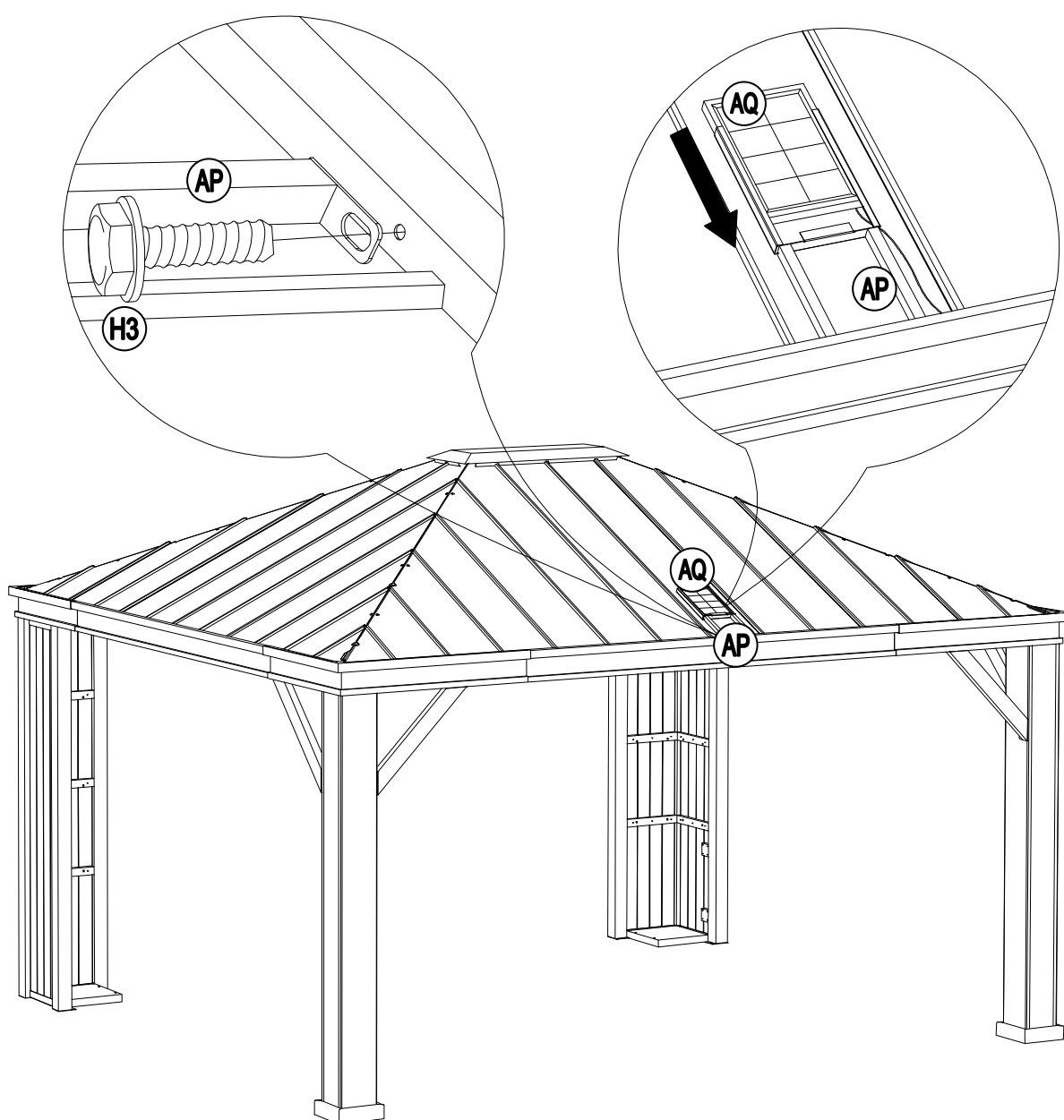
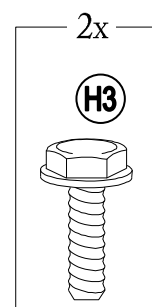
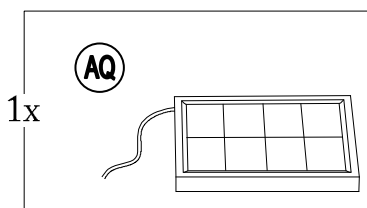
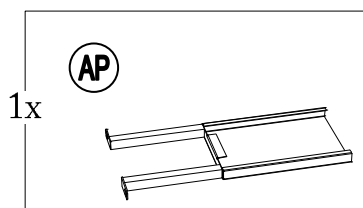

26

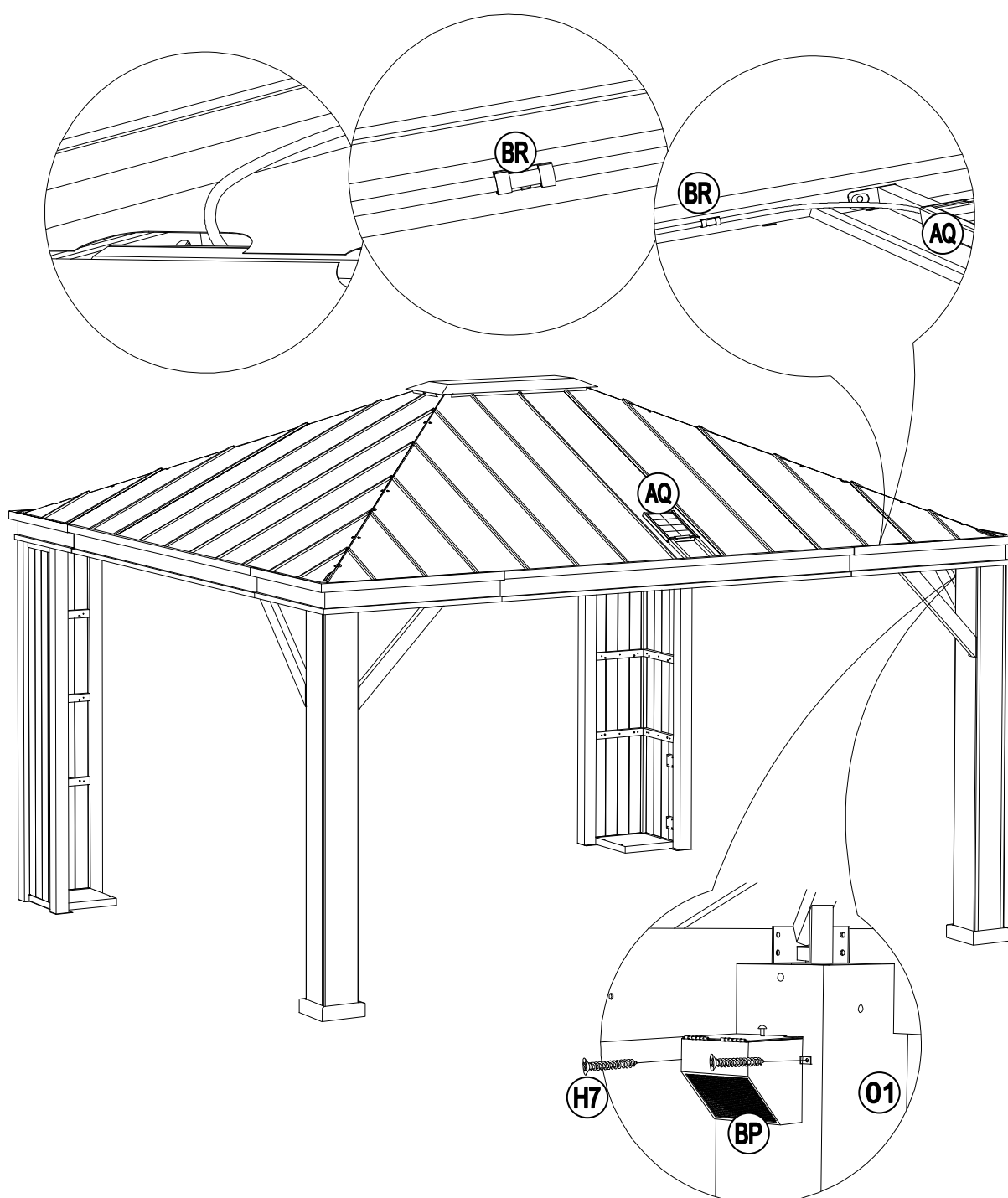
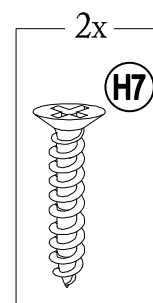
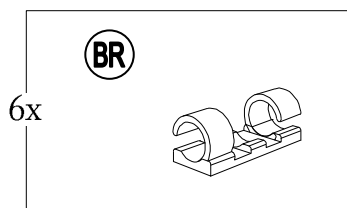
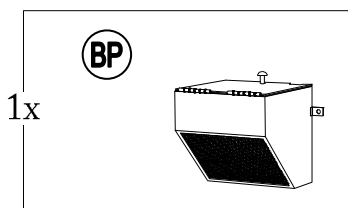

Country of Origin: China
 Pays d'origine: Chine

27

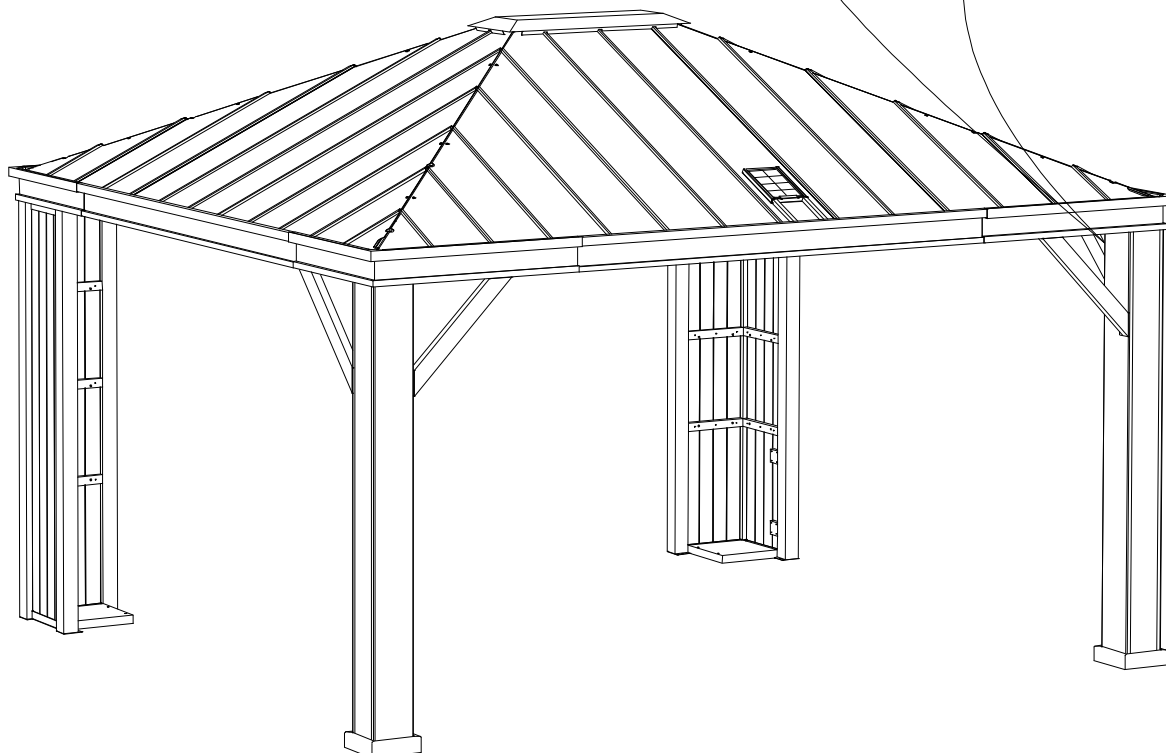
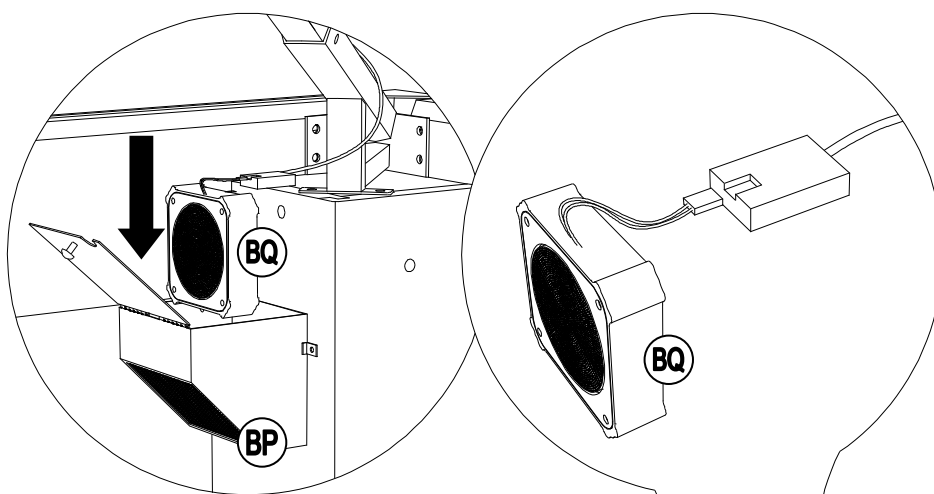
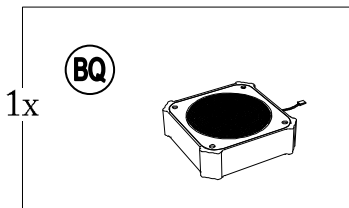

Country of Origin: China
Pais d'origine: Chine

28

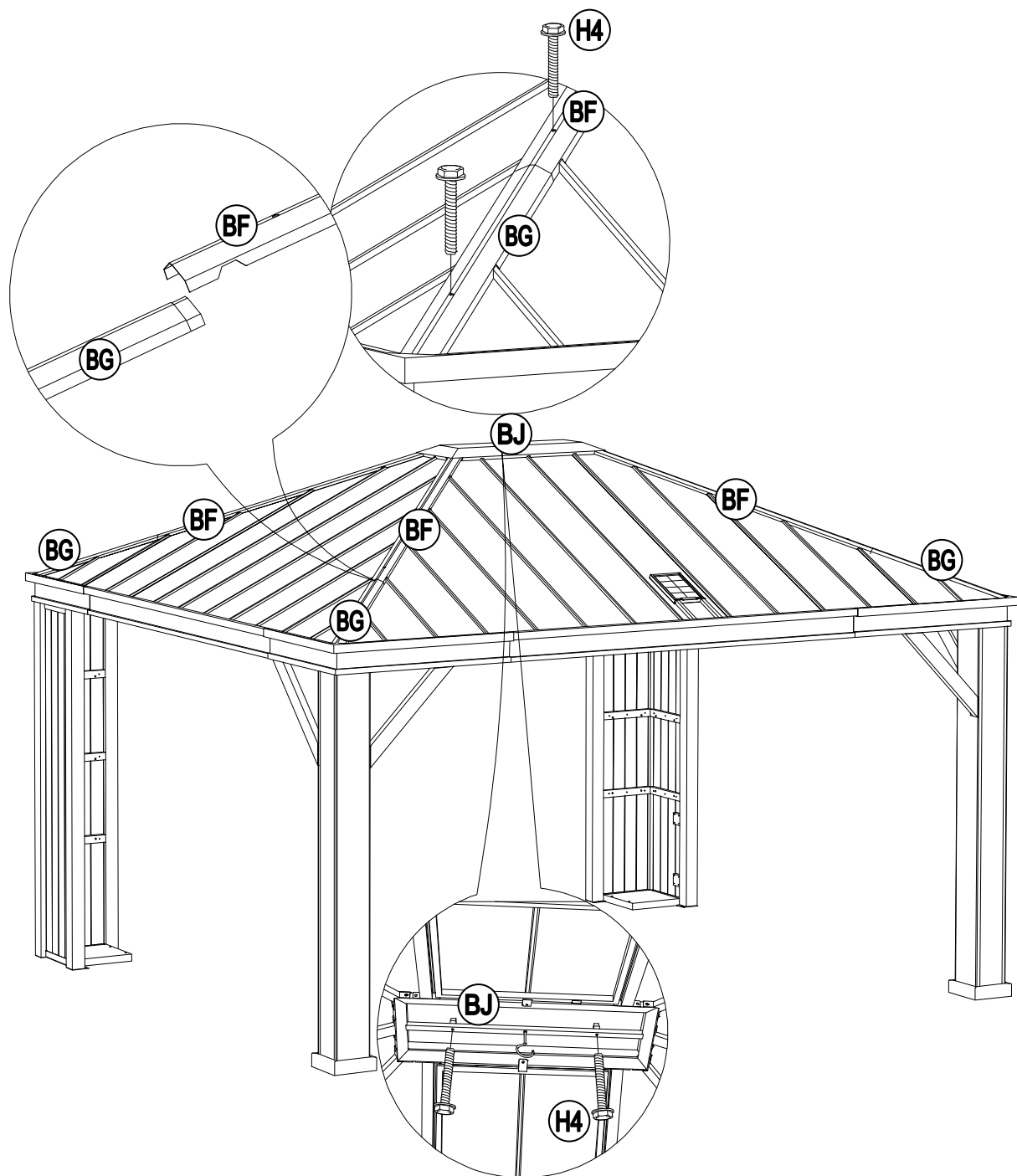
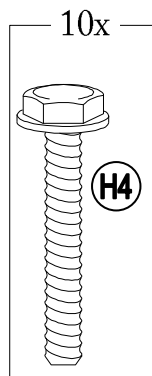
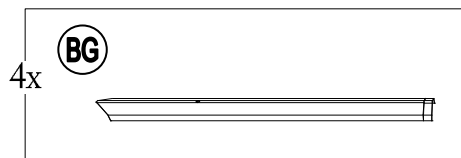
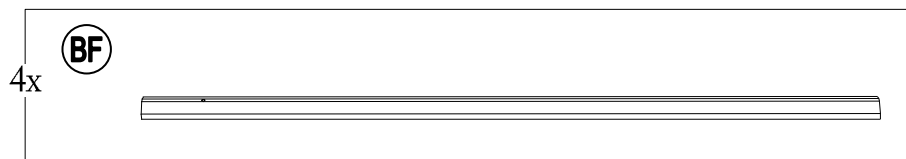

Country of Origin: China
Pais d'origine: Chine

29

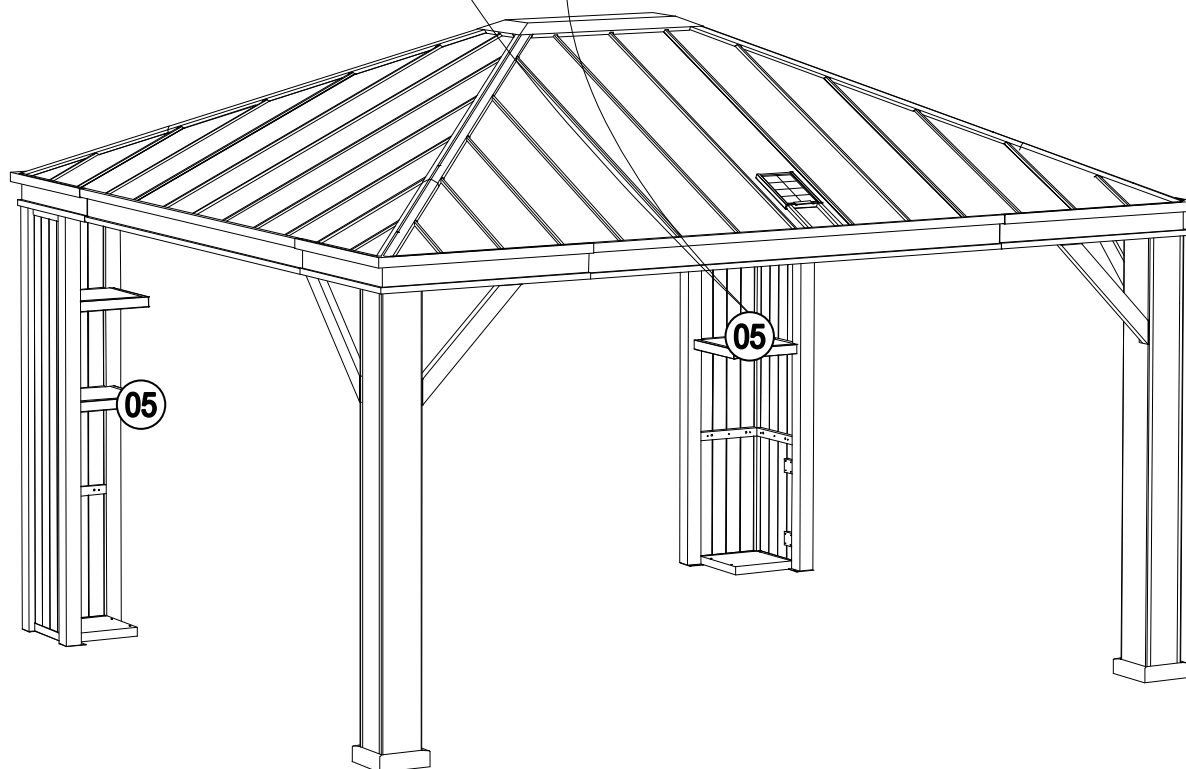
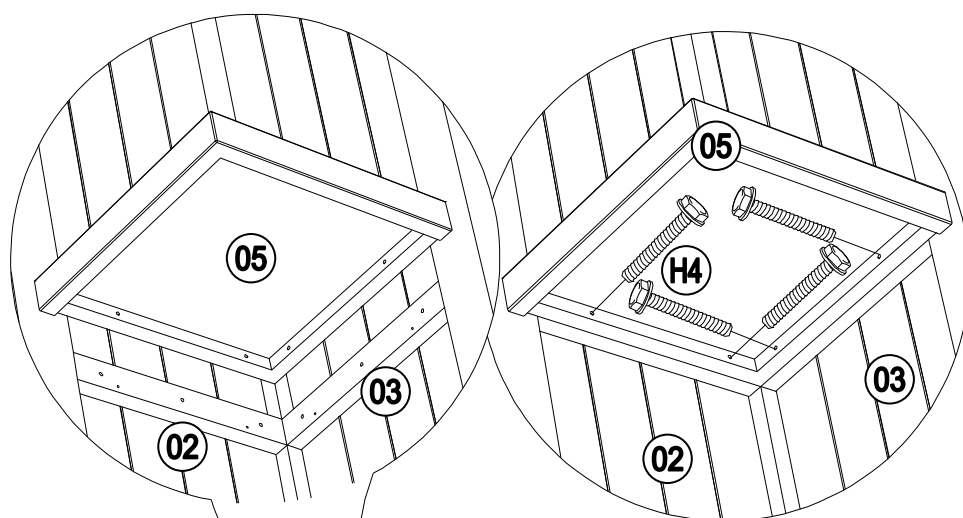
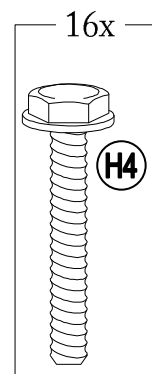
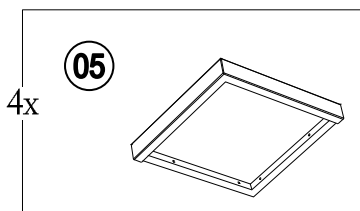

Country of Origin: China
Pais d'origine: Chine

30

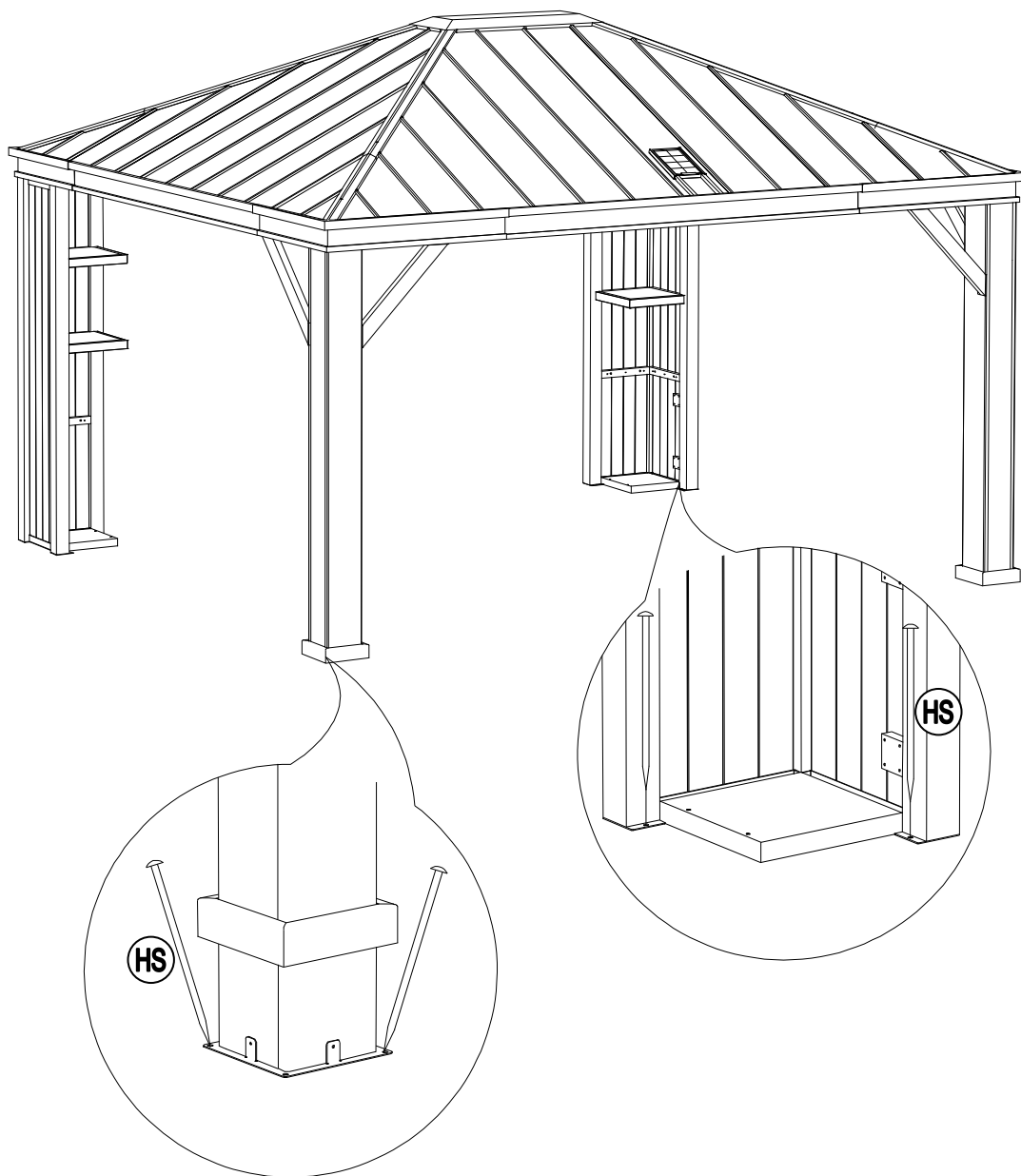
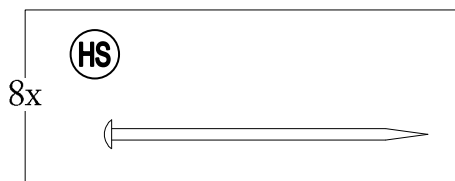

Country of Origin: China
Pais d'origine: Chine

31

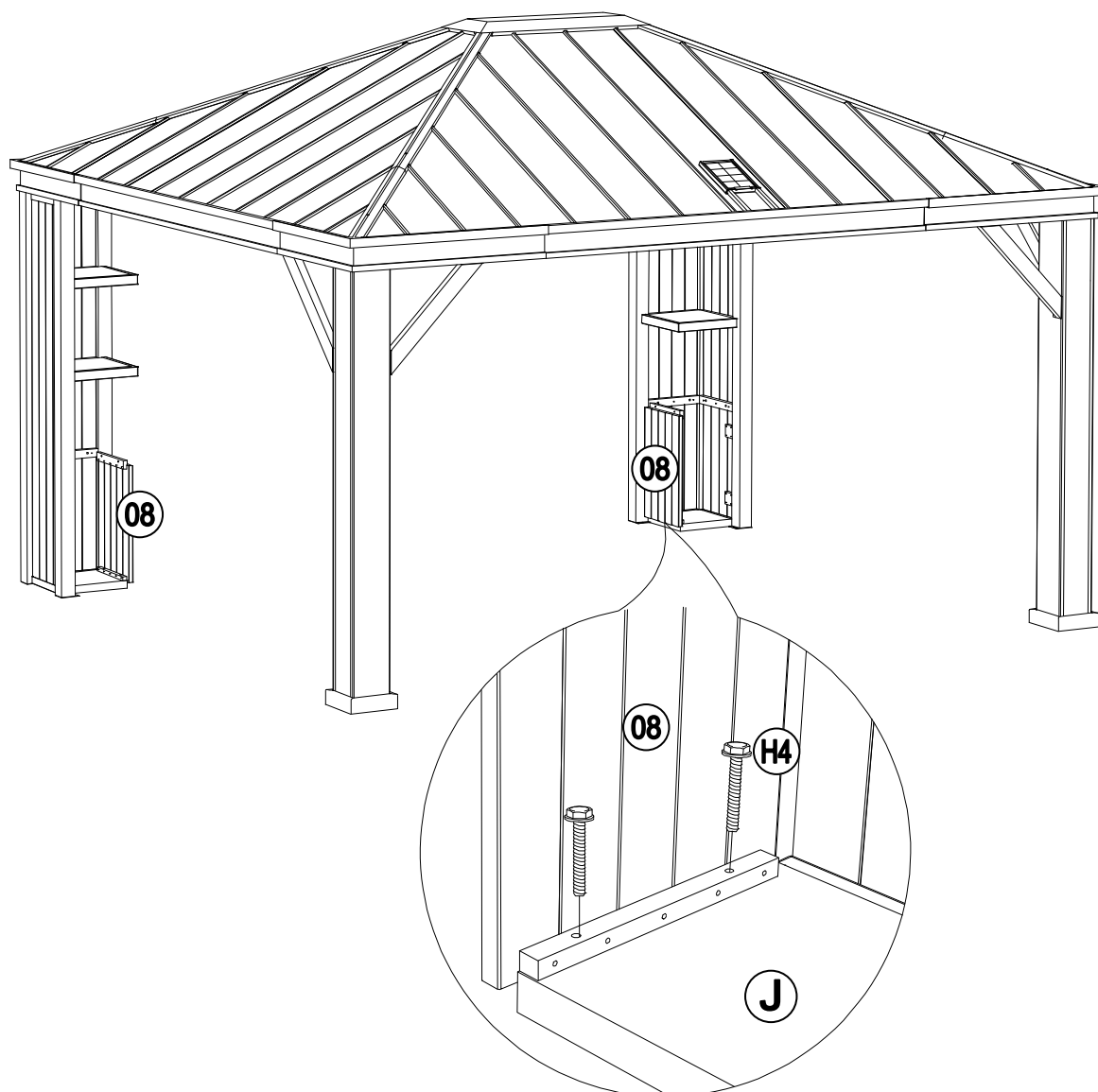
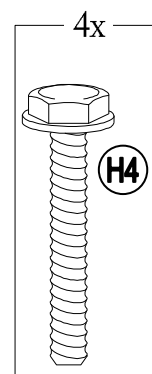
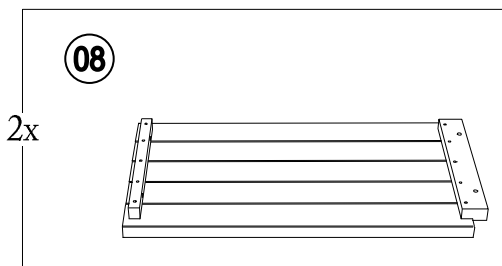

Country of Origin: China
Pais d'origine: Chine

32

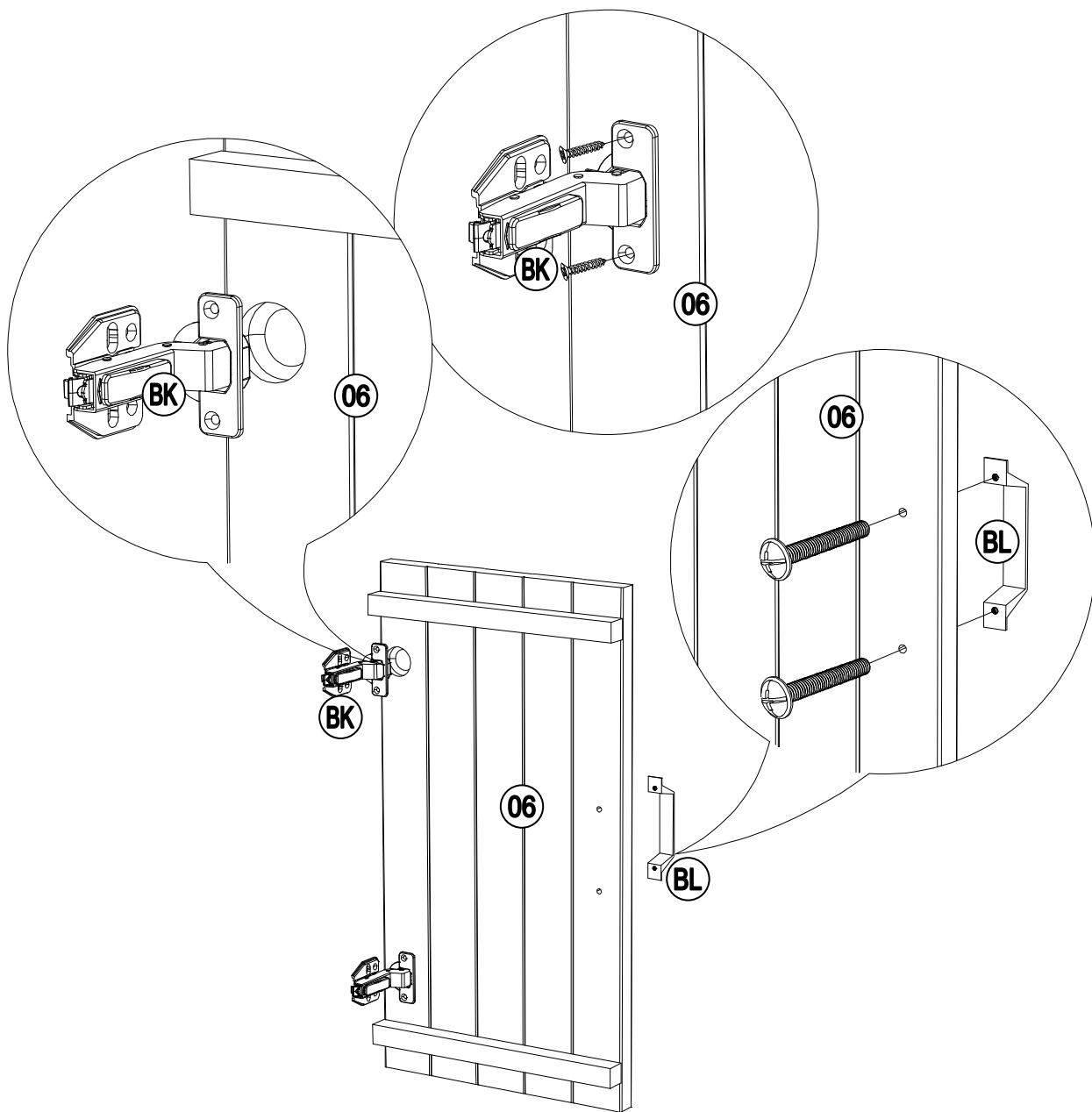
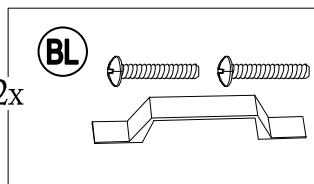
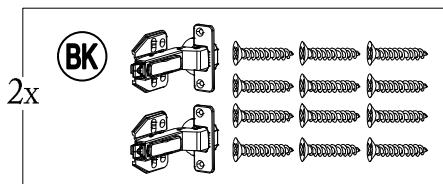
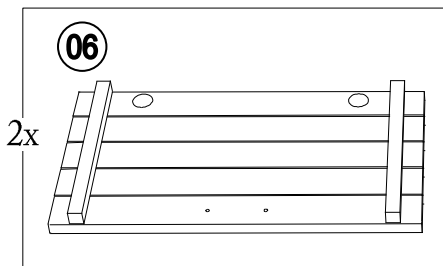

Country of Origin: China
Pais d'origine: Chine

33

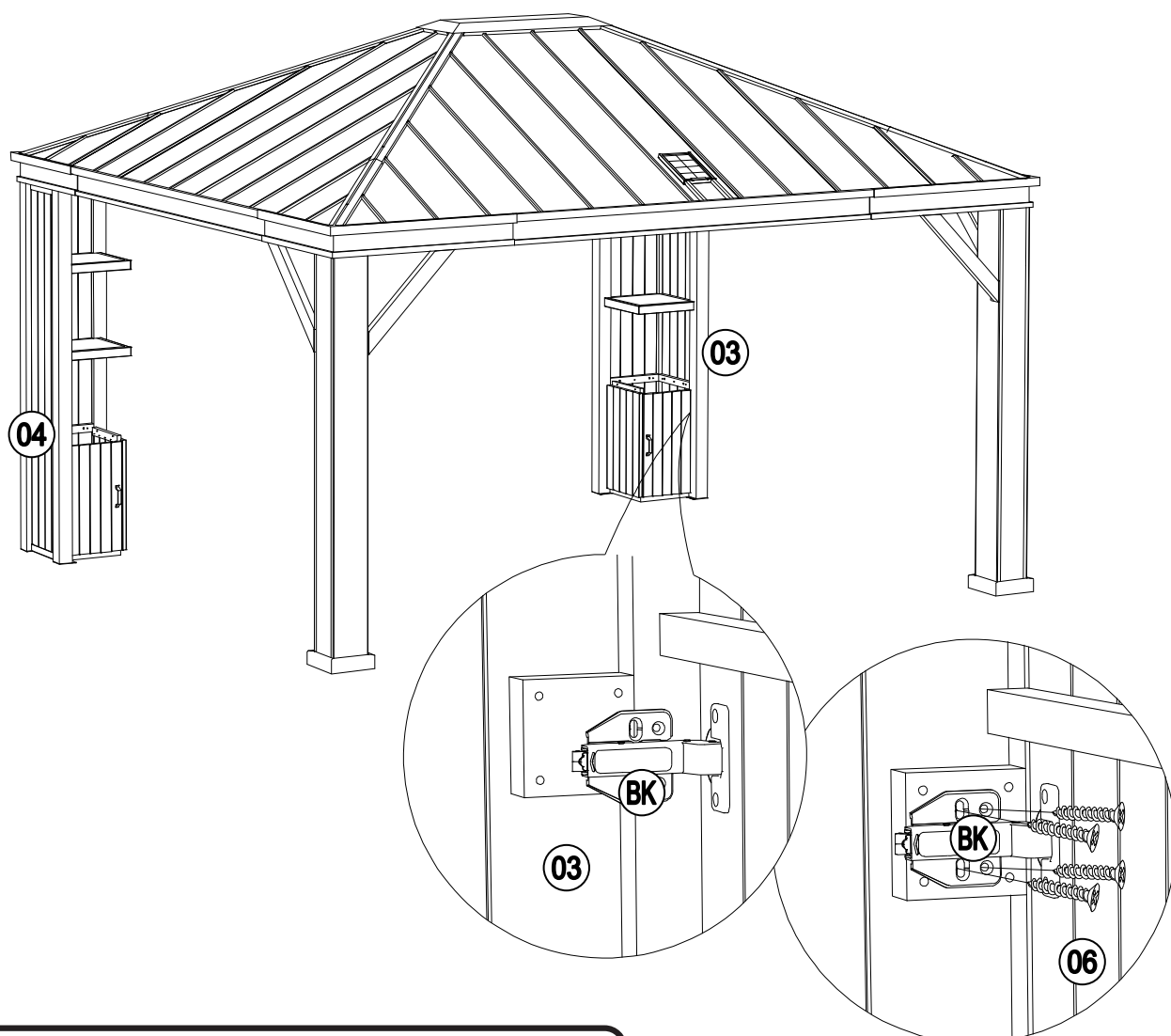

Three-way adjustable hinge for perfectly aligned doors

1. To adjust the door forward or backward.
2. To adjust the door to right or to left.
3. To adjust the door up or down.

Charnière réglable à trois niveaux pour centrer parfaitement les portes

1. Pour ajuster la porte vers l'avant ou l'arrière.
2. Pour ajuster la porte vers la droite ou la gauche.
3. Pour ajuster la porte vers le haut ou le bas.

Bisagra ajustable de tres formas, para perfecta alineación de puertas

1. Para ajustar hacia enfrente y hacia atrás.
2. Para ajustar hacia la derecha o izquierda.
3. Para ajustar hacia arriba o hacia abajo.

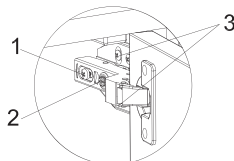

34

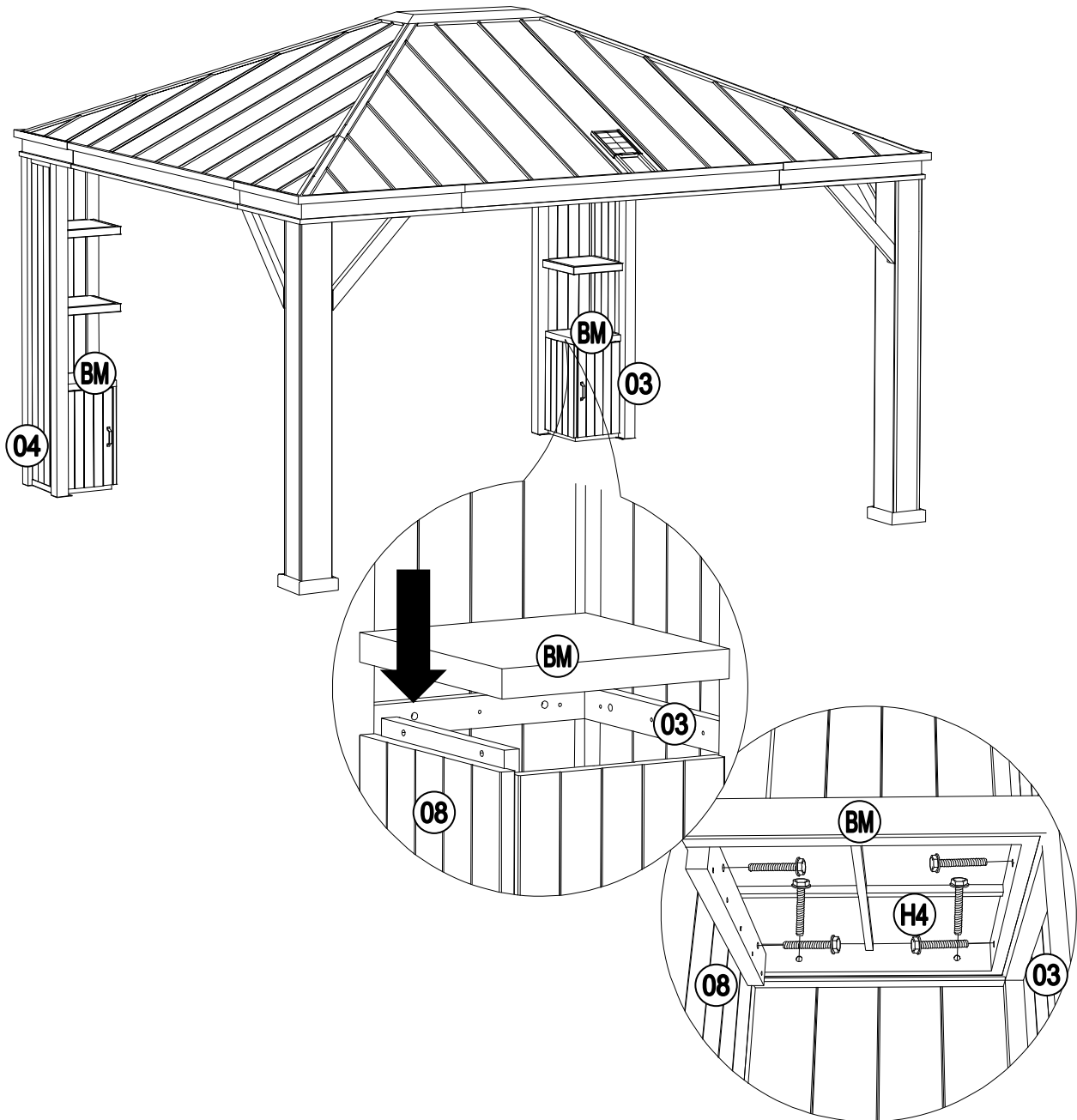
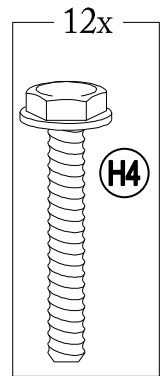
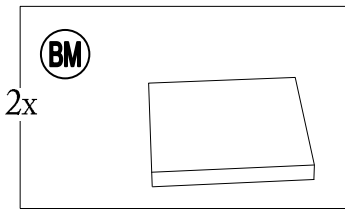

Country of Origin: China
Pais d'origine: Chine

Parts List				
Label	Part Number	Description	Qty	Part Image
BT	P00600003701	LED Lights	2	

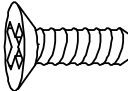
Hardware Pack				
Label	Description	Qty	Add	Part Image
H1 (Pre-installed on the LED light)	Bolt M5*15	4	0	

Country of Origin: China
Pais d'origine: Chine

Parts List				
Étiquette	Numéro de la Pièce	Description	Quantité	Numéro de la Pièce Diagramme
BT	P00600003701	Lumières LED	2	

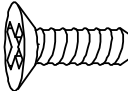
Pack Quincaillerie				
Étiquette	Numéro de la Pièce	Quantité	Add	Numéro de la Pièce Diagramme
H1 (Pré-installé sur la lumière LED)	Bolt M5*15	4	0	

Country of Origin: China
Pais d'origine: Chine

1

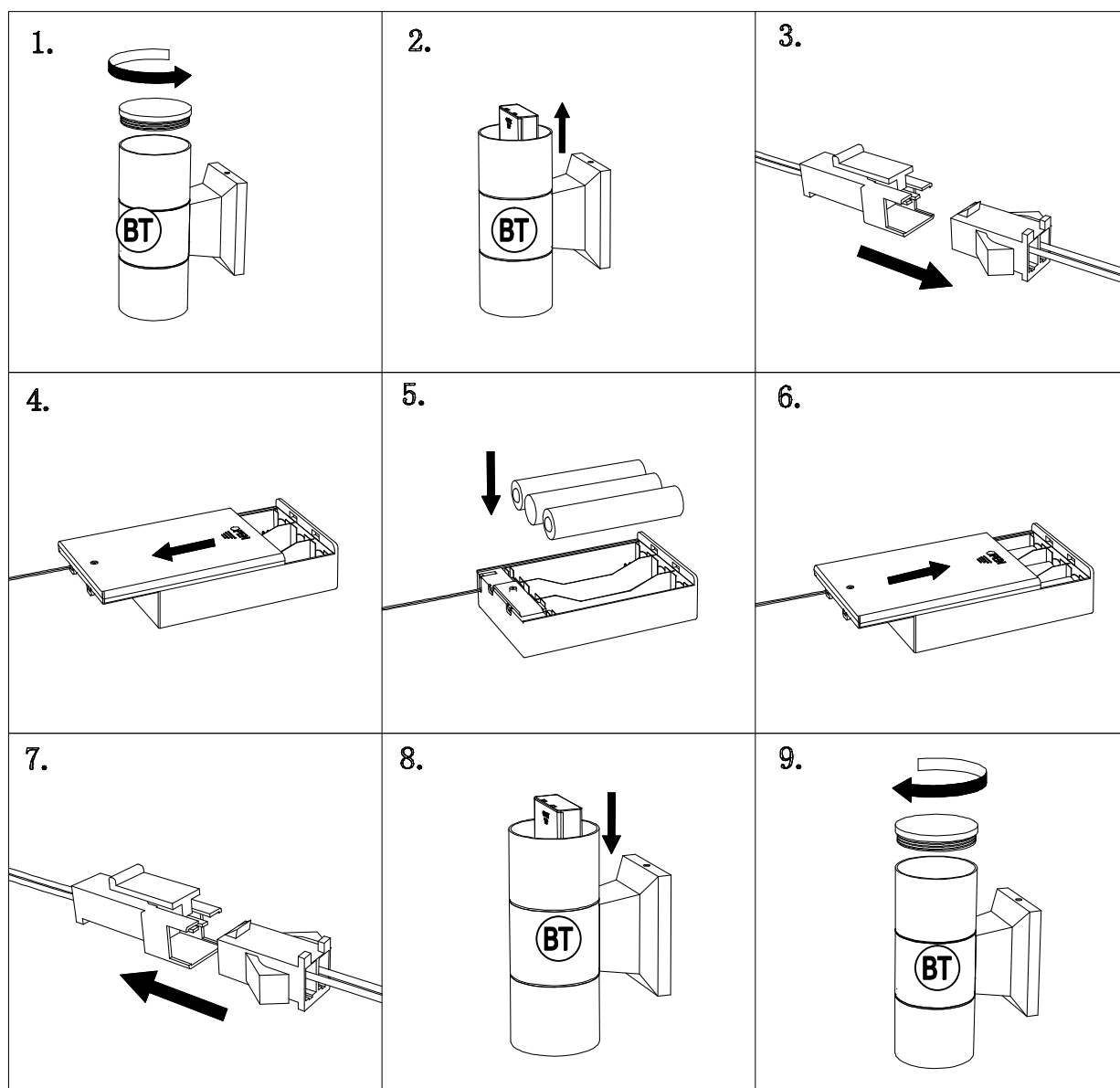
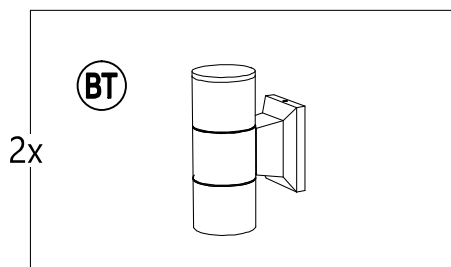

1、Lighting time/Temps d'éclairage:

battery capacity/capacité de la batterie	2000 (mah)	800 (mah)
Lighting time/Temps d'éclairage	20 (h)	8 (h)

2、Maintenance and precautions: When not in use for a long time, it is recommended to remove the battery, otherwise it will cause oxidation of the battery pack connected to the battery. / Entretien et précautions : En cas de non utilisation prolongée, il est recommandé de retirer la batterie, sinon cela provoquera l'oxydation du pack batterie connecté à la batterie.

Country of Origin: China

Pais d'origine: Chine

2

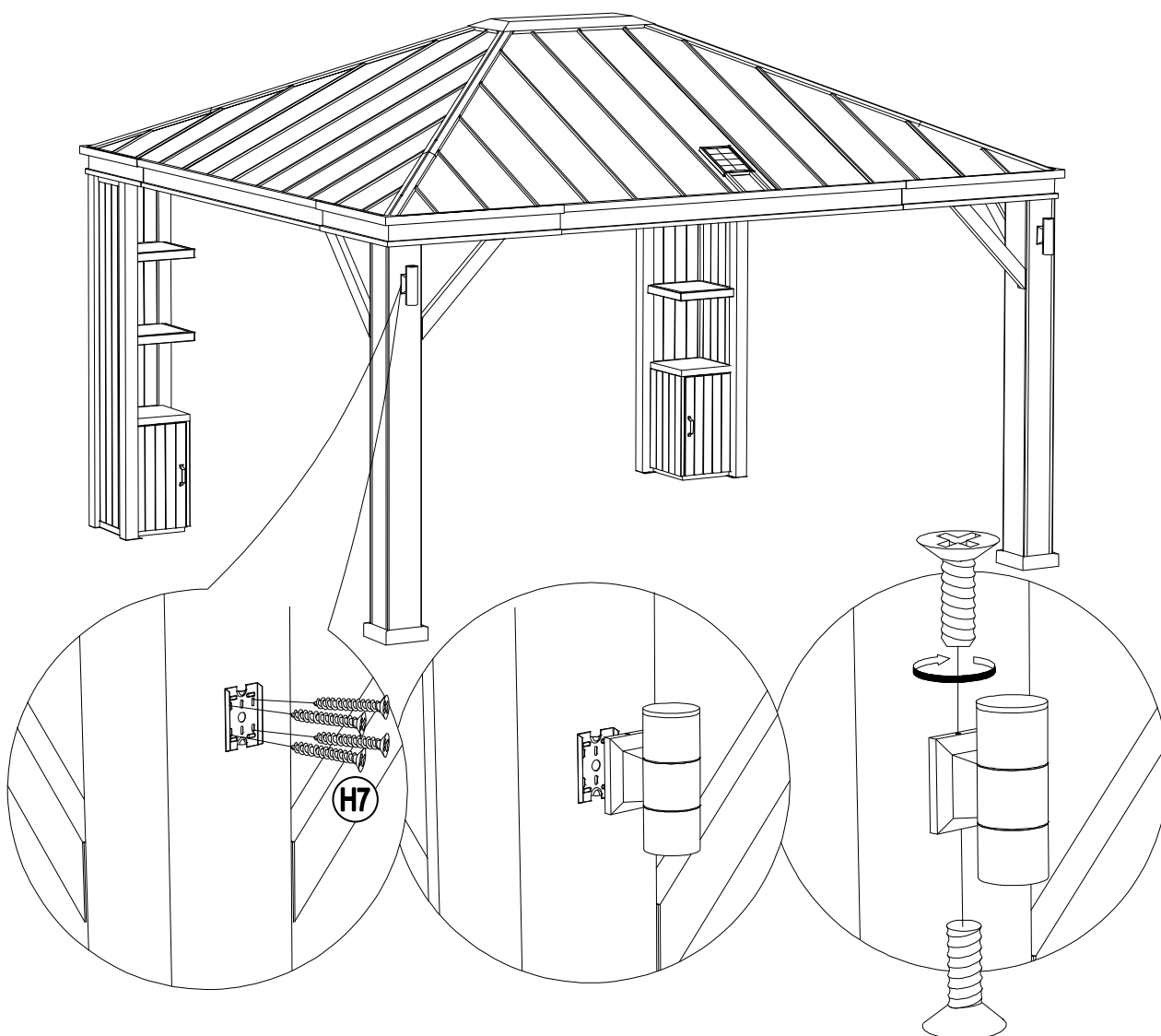
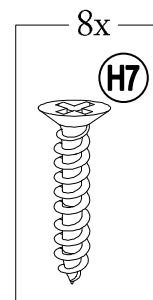
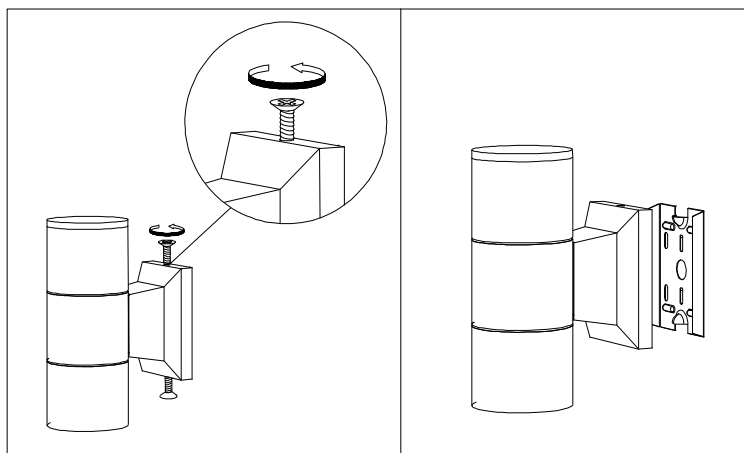

Country of Origin: China
Pais d'origine: Chine

Care and Maintenance

Our steel components for garden accessories and furniture are treated with rust inhibiting paint that protects it from rusting. However, due to the nature of steel, surface oxidation (rusting) will occur once these protective coatings are scratched. This is not a defect and thus not covered by the warranty.

To minimize this condition, we recommend care when assembling & handling the product to prevent scratching the paint. Should any scratching or damage occur, we recommend immediate touch-up with rust inhibiting paint.

Surface rust can also be easily removed with a very light application of common cooking oil. If surface oxidation (rusting) occurs and if no measure is taken to prevent this, the oxidation may start dripping on to deck or patio and caused damaging stains, which may be difficult to remove. This can be prevented if the above-mentioned measures are taken to keep the product from oxidizing.

Use damp cloth to wipe off the stains as quickly as possible.

If necessary, wash with a mild solution of soap and water; rinse thoroughly and dry completely.

Periodically check and ensure that all bolts are well-tighten during use

Limited Manufacturer's Warranty

Sunjoy Group warrants to the original purchaser that this item is free from defects in workmanship and materials for a period of **1 year** from the date of purchase, provided the item was factory-sealed at the time of purchase and is maintained with care and used only for personal, residential purposes. Should any manufacturing defect arise within this warranty period, Sunjoy Group will replace (at our option) any defective merchandise or parts upon proof of purchase; however, transportation and delivery costs, as well as payments to a third party for assembly or disassembly of the item, remain the responsibility of the purchaser. A purchaser of an "open box," previously-returned, or "clearance" item, as well as original purchasers outside of the warranty period, may obtain replacement parts from Sunjoy Group for products in current production, at nominal cost.

Exclusions

Items used for commercial, contract, or other non-residential purposes, or items damaged due to acts of nature, vandalism, misuse, or improper assembly are not covered. Corrosion or rusting of hardware is not covered. Proof of purchase (dated register receipt) is required for warranty claims. Warranty is to the original purchaser and is non-transferable. Any replacement of warranted items will be in the original style and color, or a similar style and color if the original is unavailable or has been discontinued. As some states do not allow exclusions or limitations on an implied warranty, the above exclusions and limitations may not apply. This warranty gives you specific rights, and you may also have other rights, which vary from state to state.

Country of Origin: China
Pais d'origine: Chine

Production Number: XXXXXXXXXX
Numéro de fabrication: XXXXXXXXX

Care and Maintenance

Les composants en acier de nos meubles et accessoires de jardin sont traités avec une peinture antirouille qui les protège. Toutefois, en raison de la nature de l'acier, une oxydation de la surface (rouille) se produira si ces revêtements protecteurs sont égratignés. La garantie ne couvre pas ce phénomène puisqu'il ne s'agit pas d'un défaut.

Afin de minimiser cette situation, nous recommandons d'être prudent lors de l'assemblage et de la manipulation du produit afin d'éviter d'égratigner la peinture. En cas d'égratignure ou de dommage, nous recommandons d'effectuer immédiatement une retouche avec une peinture antirouille.

La rouille de surface peut facilement être retirée à l'aide d'une petite quantité d'huile de cuisson. Si une oxydation (rouille) de la surface se produit et qu'aucune mesure n'est prise pour corriger la situation, la rouille pourrait couler sur la terrasse et causer des taches dommageables qui peuvent être difficiles à enlever. Cela peut être évité si les mesures mentionnées ci-dessus sont prises pour empêcher l'oxydation du produit.

Utilisez un linge humide pour essuyer les taches le plus rapidement possible.

Au besoin, nettoyez le produit avec une solution d'eau et de savon doux, rincez-le abondamment et séchez-le complètement.

Vérifiez périodiquement pour vous assurer que tous les écrous sont bien serrés pendant l'utilisation.

Garantie limitée du fabricant

Sunjoy Group garantit à l'acheteur initial que ce produit ne présentera aucun défaut de fabrication et de matériaux pendant une période de un an à compter de la date de l'achat si le produit a été acheté dans son emballage scellé à l'usine, et s'il a été entretenu correctement et utilisé à des fins personnelles et résidentielles seulement. Si le produit présente un défaut de fabrication pendant cette période de garantie, Sunjoy Group remplacera (à sa discrétion) toute marchandise ou pièce défectueuse sur présentation d'une preuve d'achat. Toutefois, les frais de transport et de manutention, ainsi que les paiements versés à un tiers pour l'assemblage ou le démontage du produit, demeurent la responsabilité de l'acheteur. Les acheteurs de produits avec « boîte ouverte », précédemment retournés ou « en liquidation », ainsi que les acheteurs initiaux de produits dont la période de garantie est terminée, peuvent obtenir des pièces de rechange auprès de Sunjoy Group pour des produits actuellement en production, à peu de frais.

Exclusions:

Les articles utilisés à des fins commerciales, locatives ou non résidentielles et les articles endommagés par des phénomènes naturels, des actes de vandalisme, un usage inapproprié ou un assemblage inadéquat ne sont pas couverts. La corrosion et la rouille de la quincaillerie ne sont pas couvertes. Une preuve d'achat (une copie de votre reçu daté) doit être présentée avec toute réclamation au titre de la garantie. La garantie n'est accordée qu'à l'acheteur initial et est non transférable. Si l'article original n'est plus offert, il sera remplacé par un article d'une couleur et d'un style similaires. Certains États ou certaines provinces ne permettent pas l'exclusion ou la limitation d'une garantie implicite, de sorte que les limitations et exclusions mentionnées ci-dessus peuvent ne pas s'appliquer à vous. Cette garantie vous confère des droits précis. Il est possible que vous disposiez également d'autres droits, qui varient d'un État ou d'une province à l'autre.

Country of Origin: China
Pais d'origine: Chine

Production Number: XXXXXXXXXX
Numéro de fabrication: XXXXXXXXX