

POWER SUPPLY  
**REVOLUTION D.F.**

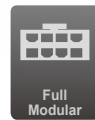



650W/750W/850W



- ▶ 80 PLUS® Gold certification
- ▶ D.F. switch for users to activate DFR™ function anytime during operation
- ▶ Smart Airflow Control (SAC) design ensures an almost inaudible operation
- ▶ Full modular design with 100% flat cables

REVOLUTION D.F. is a full modular power supply series with 80 PLUS® Gold certified efficiency. In addition, REVOLUTION D.F. comes with an exclusive D.F. switch design which offers users to activate the patented DFR™ (Dust Free Rotation) technology anytime they desire. 100% Japanese 105°C electrolytic capacitors ensure perfect durability. The built-in SAC(Smart Airflow Control) design guarantees a nearly silent operation within 70% system load. REVOLUTION D.F. is surely a perfect match for gaming systems or multi-media workstations.

## Features

- ▶ 80 PLUS® Gold certified
- 87-92% high efficiency performance @ 20-100% load

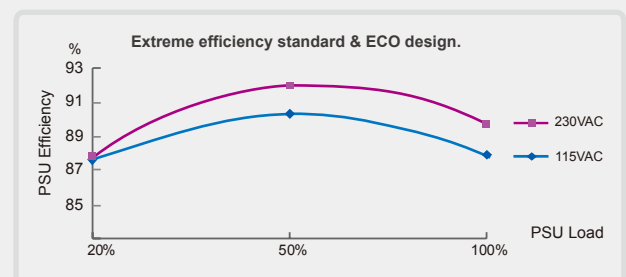

- ▶ Dust Free Rotation Tech. (patented)

Dust Free Rotation technology enables the fan to instantly blow away the dust to prolong the lifespan

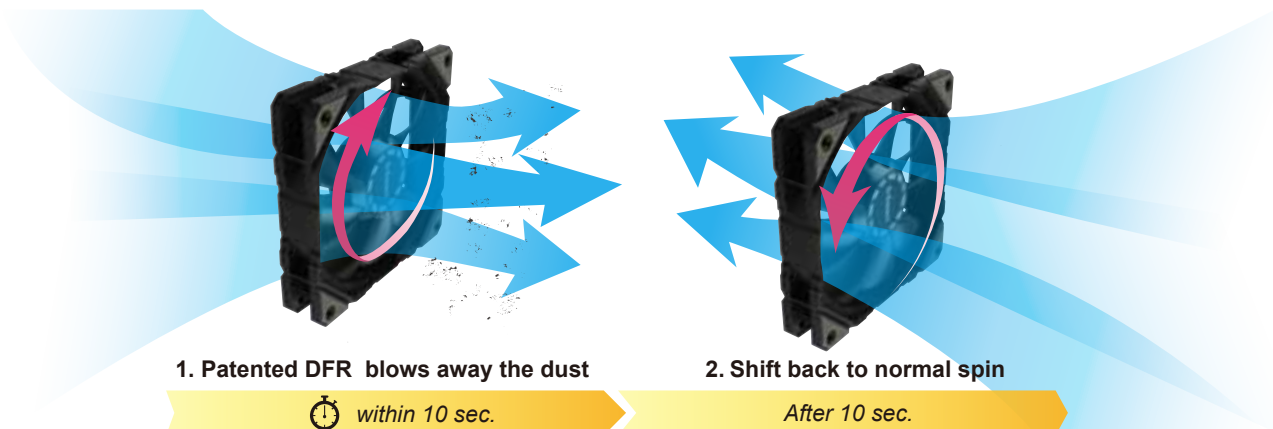

**D.F. switch**

D.F. switch design allows users to activate DFR self-cleaning function at anytime during operation

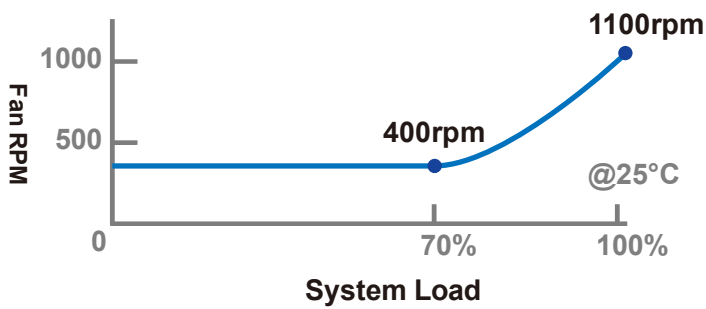

**Smart Airflow Control (SAC) design**

SAC design keeps PSU fan spinning at almost inaudible 400rpm within 70% system load to provide the optimal silent experience

**Twister Bearing fan (patented)**

Twister Bearing Technology ensures ultra silent cooling and long lifetime of fan (160,000 hours MTBF)



**100% 105°C Japanese electrolytic capacitors**

Highest component standards for maximum durability and stability

**Full modular design**

Full modular cable design facilitates system installation and cable management

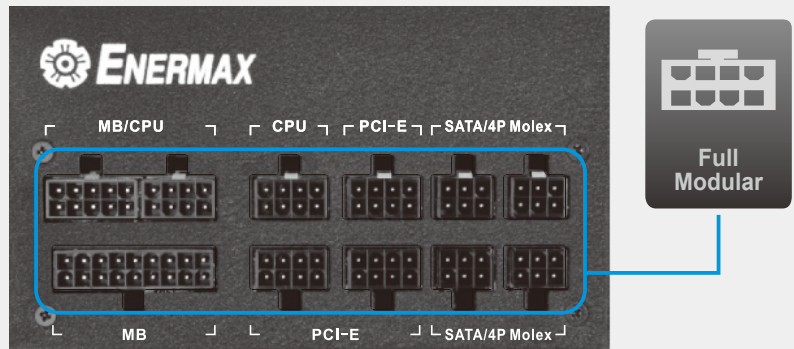

**Zero load ready!**

DC to DC converter circuit ensures stable output voltage and delivers higher efficiency

**2013 ErP Lot 6 ready**

Help system meet 2013 ErP Lot 6 (< 0.5W at standby mode) with high efficiency +5Vsb circuitry. (With 2013 ErP Lot 6 enabled motherboard)

PSU +5Vsb efficiency @ 0.045A load, 230VAC

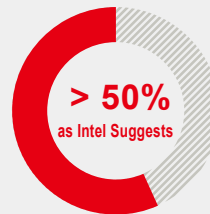

ENERMAX 2013 ErP Lot 6 Compliant PSU

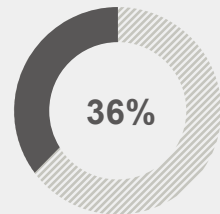

Non 2013 ErP Lot 6 Compliant PSU



**World ready!**

100-240VAC auto-adjustment input for universal use. Active PFC with PF value up to 0.99, reducing the reactive power loss to the minimum

### SafeGuard

Multiple protection circuitry of OCP, OVP, UVP, SCP, OPP and OTP protects your system

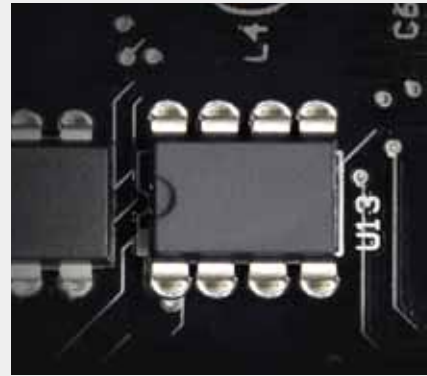

### Dimension

Unit: mm

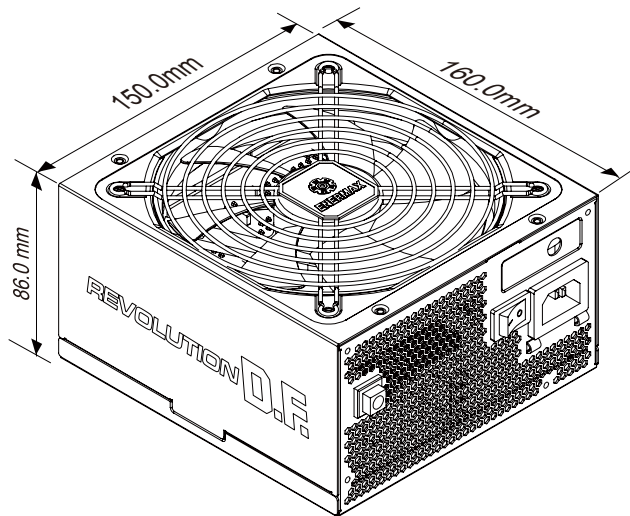



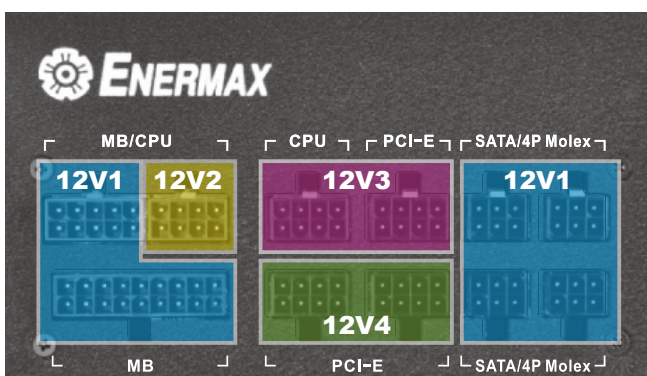



### 12V Rails Distribution



This product incorporates multiple 12V rails over current protection. If you let many peripherals consume the power on only one 12V rail, it may trigger the over current protection and shut down the system. Please re-direct certain peripheral power cable to other 12V rail to share the current loading to ensure highest stability and safety

## Cables & Connectors

Model	Connectors					
						
	24P MB	4+4P (8P) CPU	6+2P (8P) PCI-E	SATA	4P Molex	FDD (adapter)
	60cm	70cm	50/15cm	45/15/15/15cm	45/15/15/15cm	10cm
ERF650AWT	1	1	4	8	4	1
ERF750EWT	1	2	4	8	4	1
ERF850EWT	1	2	6	12	4	1

## Specifications

Model Number	ERF650AWT		ERF750EWT		ERF850EWT	
AC Input Voltage	100-240VAC, 47-63Hz				100-240VAC, 47-63Hz	200 -240VAC, 47-63Hz
AC Input Current	10A		10A		12A	6A
	DC Output					
	Rated	Combined	Rated	Combined	Rated	Combined
+3.3V	20A	100W	22A	120W	22A	120W
+5V	20A		22A		22A	
+12V1	25A	650W	25A	750W	25A	850W
+12V2	25A		25A		25A	
+12V3	30A		35A		40A	
+12V4	30A		35A		40A	
-12V	0.3A	3.6W	0.3A	3.6W	0.3A	3.6W
+5Vsb	2.5A	12.5W	2.5A	12.5W	2.5A	12.5W
Total power	650W		750W		850W	
Dimensions	150(W)*86(H)*160(D) mm					



### Shipping Information

Model		ERF650AWT	ERF750EWT	ERF850EWT
Bar Code	EAN	4713157723949	4713157723956	4713157723963
	UPC	819315023945	819315023952	819315023969
Box Dimensions	248 x 233 x 96.5mm			
Gross Weight / unit	2.67 kg	2.8 kg	3 kg	
Carton Dimensions	500 x 280 x 330mm			
Q'ty / carton	6			
Gross Weight / carton	17.02 kg	17.8 kg	19 kg	