



EMB550AWT
EMB650AWT
EMB750EWT
EMB850EWT

MARBLEBRON

MARBLEBRON



- 80 PLUS® Bronze certified
- Semi-modular design with black flat cables
- 120mm high pressure fan with Smart Airflow Control design
- 105°C Japanese electrolytic capacitors
- DC to DC circuit design
- Multiple circuitry protection



Features

- **Compatibility and Easy Usage**
 - Semi-modular design offers flexibility of cables
 - Low-profile black flat cables is easy to bend and storage inside the PSU shroud
 - Single rail +12V design can simply installed and it can avoid shutting down from heavy usage
- **Efficiency**
 - 80+ Bronze certified with 88% efficiency @50% load
 - Efficient +5Vsb circuitry consume only under 0.5W at standby mode
- **Advanced Technology**
 - DC to DC circuit
 - Active PFC design with PF value up to 0.99
 - Auto-adjustment input
 - 105°C Japanese electrolytic capacitors
- **Silent Cooling Performance**
 - Equipped with 120mm high-pressure fan
 - Introduce into SAC (Smart Airflow Control) design
- **Safety**
 - Multiple circuitry protection of OCP, OVP, UVP, OPP, SCP, and OTP



Semi-modular Design



Flexible Flat Cable Design

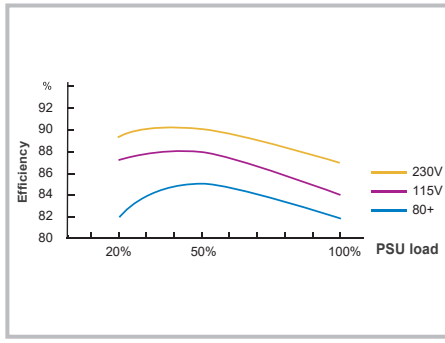

80 PLUS® Bronze Certified

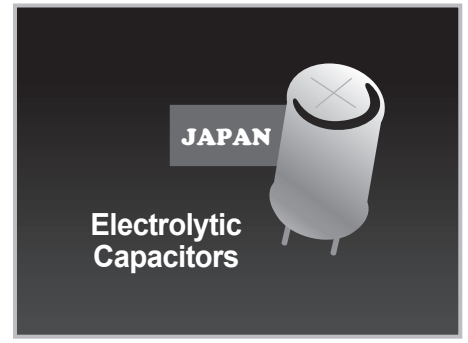

Japanese Electrolytic Capacitors

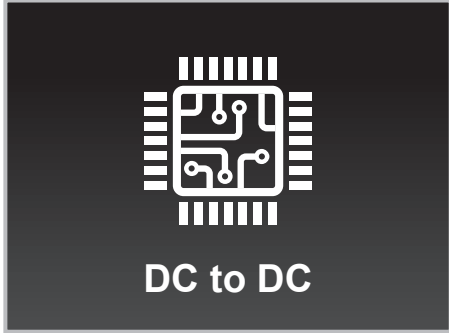

DC to DC Technology

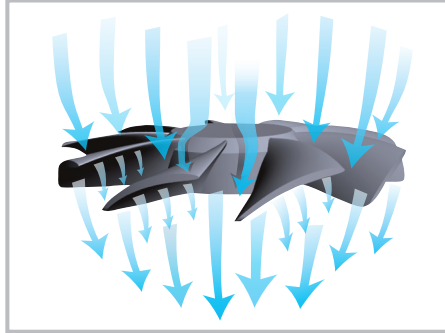

120mm High Pressure Fan

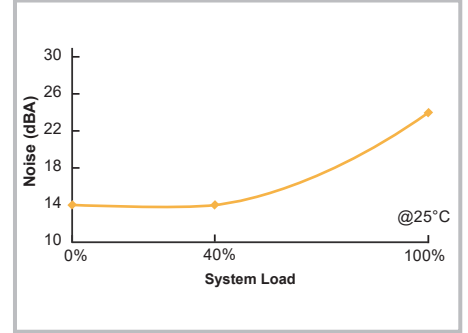

SAC (Smart Airflow Control) Design

Dimension



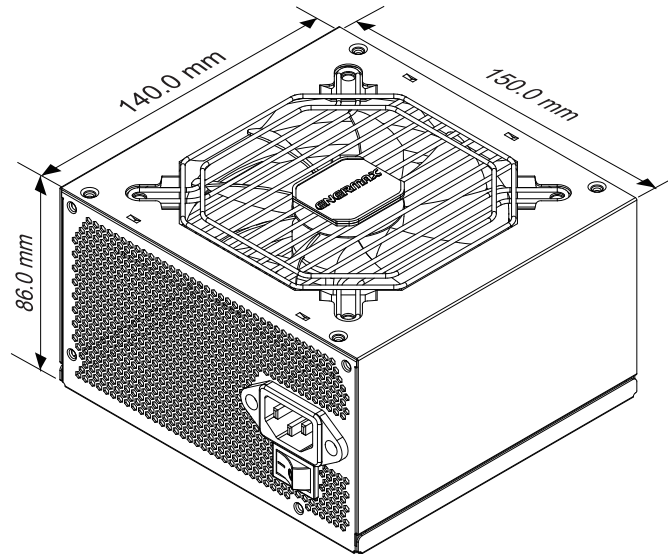





Unit : mm



Cables & Connectors

Model	Native Cables			Modular Cables		
	Mainboard 24P	CPU 4+4P (8P)	PCI-E 6+2P (8P)	SATA	4P Molex	FDD (adapter)
850W	1	2	4	8	4	1
750W	1	2	4	8	4	1
650W	1	1	4	8	4	1
550W	1	1	2	6	4	1

Specifications

Model	EMB550AWT		EMB650AWT		EMB750EWT		EMB850EWT	
AC Input Voltage	100-240VAC, 47-63Hz							
AC Input Current	8-4A		10-5A		11-5.5A		11-5.5A	
DC Output								
	Rated	Combined	Rated	Combined	Rated	Combined	Rated	Combined
+3.3V	20A	110W	20A	120W	20A	130W	20A	130W
+5V	20A		20A		20A		20A	
+12V1	45A	540W	54A	648W	62A	744W	70A	840W
-12V	0.3A	3.6W	0.3A	3.6W	0.3A	3.6W	0.3A	3.6W
+5Vsb	2.5A	12.5W	2.5A	12.5W	2.5A	12.5W	2.5A	12.5W
Total Power	550W		650W		750W		850W	
Dimensions	150(W) x 86(H) x 140(D)mm							
        								
Logistic Information								
Model	EMB550AWT		EMB650AWT		EMB750EWT		EMB850EWT	
Bar Code	EAN	4713157724977	4713157724984	4713157724991	4713157726063			
	UPC	819315024973	819315024980	819315024997	819315026069			
Box Dimension	248 x 211 x 95 mm							
Gross Weight / Unit	1.94kgs		2.16kgs		2.28kgs		2.28kgs	
Carton Dimension	495 x 263 x 231 mm							
Q'ty / Carton	5pcs							
Gross Weight / Carton	10.2kgs		11.3kgs		11.9kgs		11.9kgs	