



ELC-LMT360-W-ARGB

ELC-LMT240-W-ARGB

LIQMAX III
ARGB VERSION



LIQMAX III

ARGB VERSION



- The luminous addressable RGB fan and Aurabelt™ water block design
- Central Coolant Inlet (CCI) combined with patented Shunt-Chanel Technology (SCT) design
- Exclusive dual-convex blades

Features

- Show your own uniqueness
 - The luminous addressable RGB fan and Aurabelt™ water block
 - 2 ways to control RGB lighting effects
 - White AIO CPU cooler
- Enhanced cooling performance
 - The combination of dual-chamber pump and CCI plus SCT technology
 - Dual Chamber water block design (patented)
 - Central Coolant Inlet (CCI) design combined with patented Shunt-Chanel Technology (SCT) cold plate
 - Exclusive dual-convex blades
- More durable and stable
 - Anti-vibration rubber pad on four-side fan frame
- User-friendly and compatibility
 - 400 mm weaved tubing
 - All-in-one bracket plate

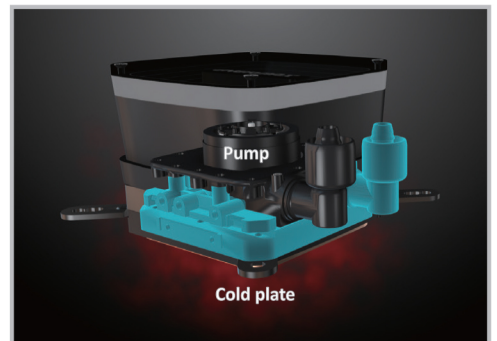

Dual Chamber water block design (patented)

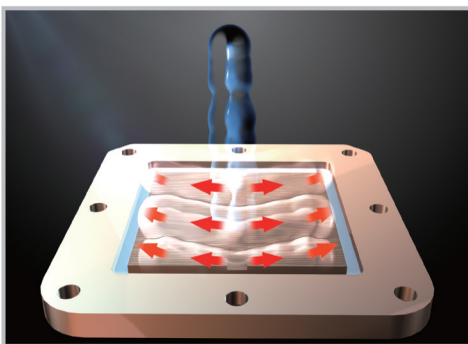

Central Coolant Inlet (CCI) design combined with patented Shunt-Chanel Technology (SCT) cold plate

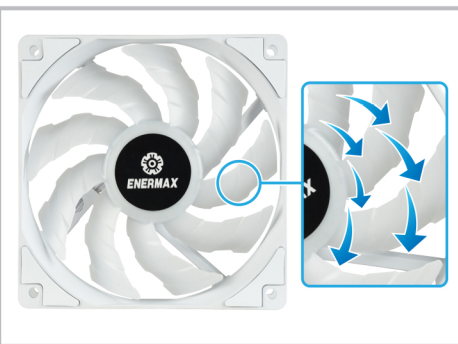

Exclusive dual-convex blades

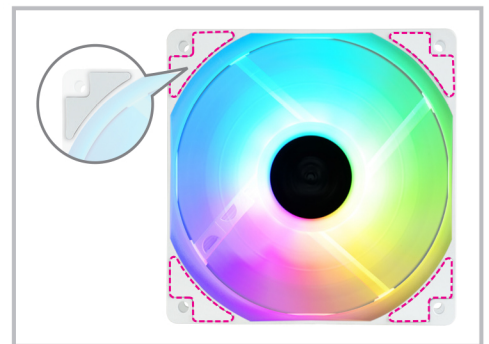

Anti-vibration rubber pad on four-side fan frame



The Aurabelt™ water block with 16.8 million color options

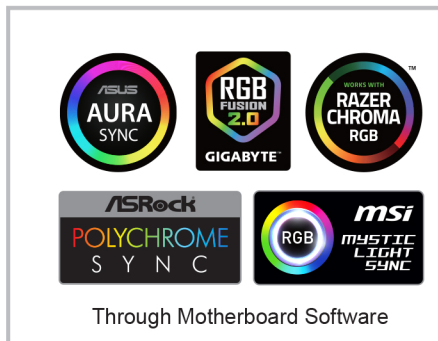

Through Motherboard Software



By Included ENERMAX RGB controller (* only available for ELC-LMT360-W-ARGB)

2 ways to control RGB lighting effects

Dimension

unit:mm

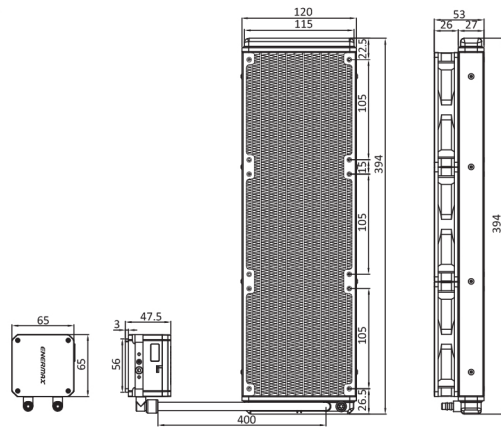

ELC-LMT360-W-ARGB

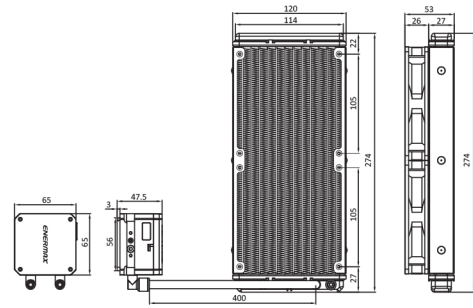

ELC-LMT240-W-ARGB

Specifications

Model		ELC-LMT360-W-ARGB	ELC-LMT240-W-ARGB
CPU Socket		Intel® LGA 1700/2066/2011-3/2011/1366/1200/1156/1155/1151/1150 AMD® AM5/AM4/AM3+/AM3/AM2+/AM2/FM2+/FM2/FM1	
Material		Copper Base with Aluminum Radiator	
Radiator		394 x 120 x 27 mm	274 x 120 x 27 mm
Pump	Bearing	Ceramic Bearing	
	MTBF	50,000 hrs	
	Motor Speed	3100 RPM ± 10%	
	Rated Voltage	12V	
Water Block	Rated Current - Pump	0.4A 【 or 0.53A if not connected to 3 pin ARGB connector (5V/D/-/G) 】	
	Rated Current - RGB LED	0.18A	
Tube	Material	Rubber	
	Length	400 mm	
Weight (W/O fan)		968 g	795 g
Fan	Dimension	120 x 120 x 25 mm	
	MTTF	≥ 50,000 hr	
	Speed	500-1600 rpm	
	Rated Voltage	12V	
	Rated Current-Fan	0.17A	
	Rated Voltage - RGB LED	5V	
	Rated Current - RGB LED	0.36A	
	Air Flow	22.5~72.1 CFM	
	Static Pressure	0.2~1.98 mm-H2O	
	Noise Level	14~27 dBA	
Connector		4 pin PWM connector 3 pin ARGB connector (5V/D/-/G)	
Accessory	RGB Controller	Yes	No
Thermal Grease		Dow Corning® TC-5121C	
Logistic information			
Bar code	EAN	4713157725387	4713157726056
	UPC	819315025383	819315026052
Box dimension		448 x 205 x 137 mm	322 x 205 x 137 mm
Gross Weight / unit		2.192 kg	1.75 kg
Carton dimension		467x 292x 440 mm	435 x 338 x 440 mm
Q'ty / carton		4pcs	6pcs
Gross Weight / carton		9.788 kg	11.65 kg