

ETS-T40fit



ETS-T40F-TB



ETS-T40Fit

CPU Air Cooler

- 200W TDP supported
- Perfect RAM compatibility

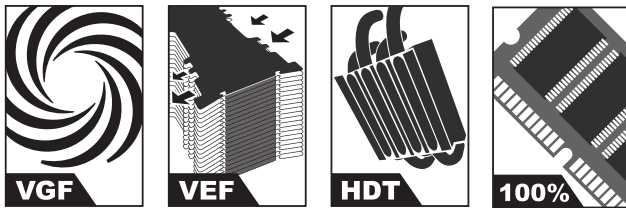

ENERMAX ETS-T40Fit series air cooler is rated with 200W thermal dissipation power thanks to its patented VGF (Vortex Generator Flow), VEF (Vacuum Effect Flow) fins, and the base are with HDT (Heat-pipe Direct Touch) structure. The slim heat sink ensures perfect compatibility with extended dimension RAM, whether single or dual fans attached.



Features

- Compact side flow air cooler for perfect RAM compatibility

The slim 42.5mm depth heat sink offers great compatibility with extended dimension RAM, whether single or dual fans attached.

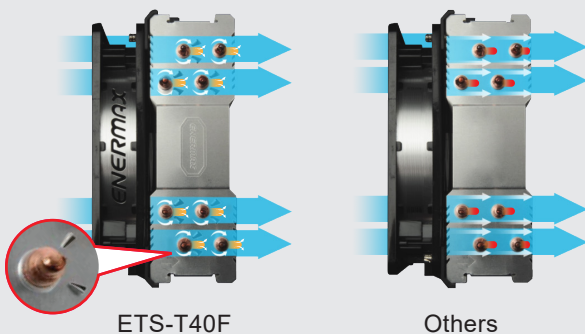

- Patented VGF (Vortex Generator flow) to increase air convection around the heat pipes

- Unique air path creating high VEF (Vacuum Effect flow) to optimize the airflow

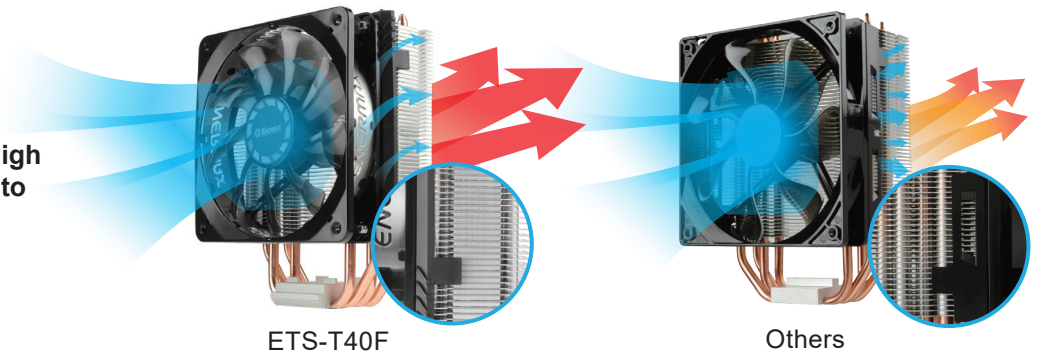

ETS-T40F

Others

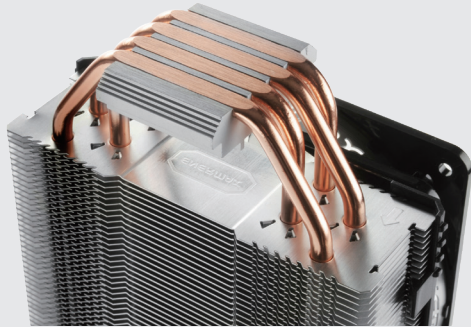

- HDT (Heat-pipe direct touch) technology to ensure rapid thermal conduction and eliminate CPU hot spots

- Twister Bearing technology

Patented Twister Bearing fan features stable operation and long lifespan of 160,000 hours MTBF. Furthermore, the detachable blade allows easy cleaning and maintenance.

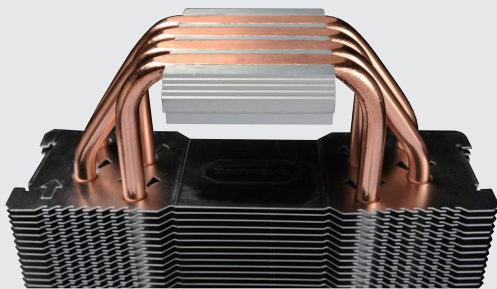
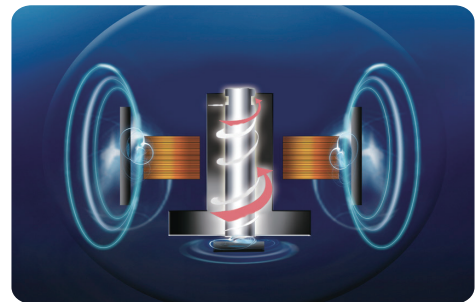

- 4 x Ø6mm heat pipes

High performance heat pipes offer great heat conductivity from CPU to the heat sink.

- Fan RPM reduction adaptor

The fan RPM reduction adaptor reduces 50% fan speed and the noise. A great tool to achieve silent operation.





▀ **Dual fan installation option**

Additional fan bracket enables dual fans installation in push / pull setting to enhance the cooling performance.

▀ **High thermal conductivity grease Dow Corning® TC5121**

Dow Corning® TC-5121 thermal grease ensures the perfect thermal conduction

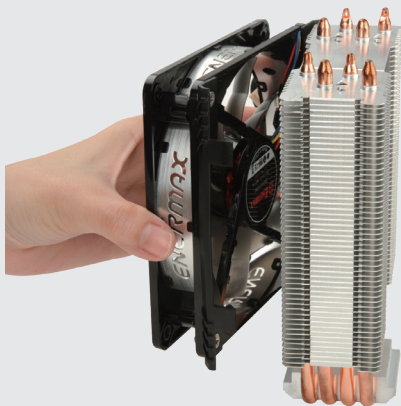

▀ **"1-Clip" fan bracket**

"1-Clip" fan bracket design for user-friendly installation

Dimension

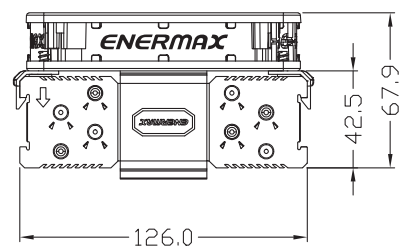
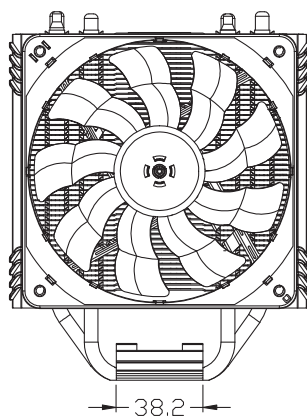
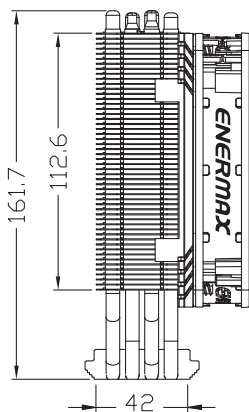

unit : mm

Specifications

Model		ETS-T40F-TB
Compatible Socket	Intel® LGA 1700/2066/2011-3/2011/1366/1200/1156/1155/1151/1150 AMD® AM4/AM3+/AM3/AM2+/AM2/FM2+/FM2/FM1	
Heat Sink Dimension (mm)	126(L) x 40(W) x 161.7(H)	
Weight	460g	
Heat Pipe	4 x Ø6 mm	
Material	Copper Heat Pipes / Aluminum Fins	
Thermal Grease	Dow Corning® TC5121	
Fan	Fan Dimension (mm)	120 x 120 x 25 mm
	Speed	800-1800 RPM 400 ~ 900 RPM (w/ fan adaptor)
	Air Flow	37.57 ~ 86.70 CFM ; 63.83 ~ 147.3 m³/h 21.21 47.72 CFM ; 36.04 ~ 81.08 m³/h (w/ fan adaptor)
	Air Pressure	0.72 ~ 2.41 mmH ₂ O / 0.31 ~ 1.31 mmH ₂ O (w/ fan adaptor)
	Rated Voltage	12 V
	Bearing Type	Twister Bearing
	MTBF	160,000 hours
	Noise	10 ~ 21 dBA / 8 ~ 11 dBA (w/ fan adaptor)
	Connector	4 pin PWM connector
Logistic information		
Barcode	EAN: 4713157721914 UPC: 816163008247	
Box Dimension	160 x 124 x 186 mm	
Gross Weight / Unit	960g	
Carton Dimension	492 x 260 x 393 mm	
Gross Weight / Carton	12.8kg (12 units per carton)	