

BOSCO KB60D

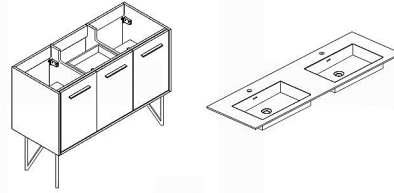

Dimensions:	width	depth	height
inches	59.125"	19.75"	35.75"
mm	1502	502	908

NOTE: DIMENSIONS AND TECHNICAL DETAILS ARE SUBJECT TO CHANGE WITHOUT NOTICE

FRONT ELEVATION

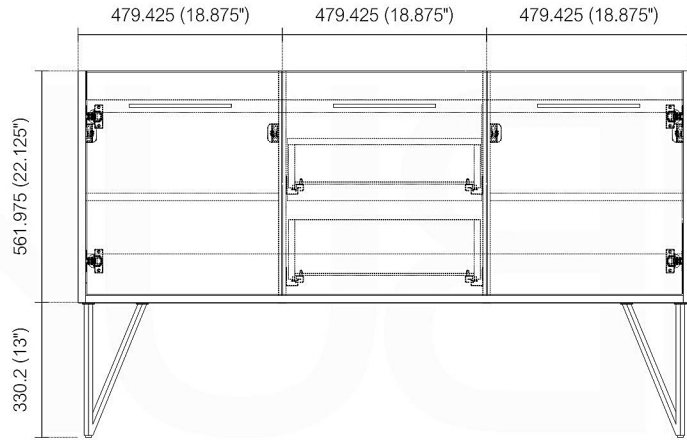

SIDE ELEVATION

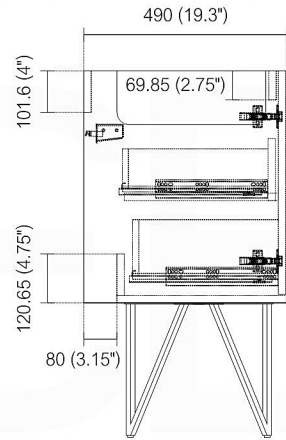

TOP ELEVATION

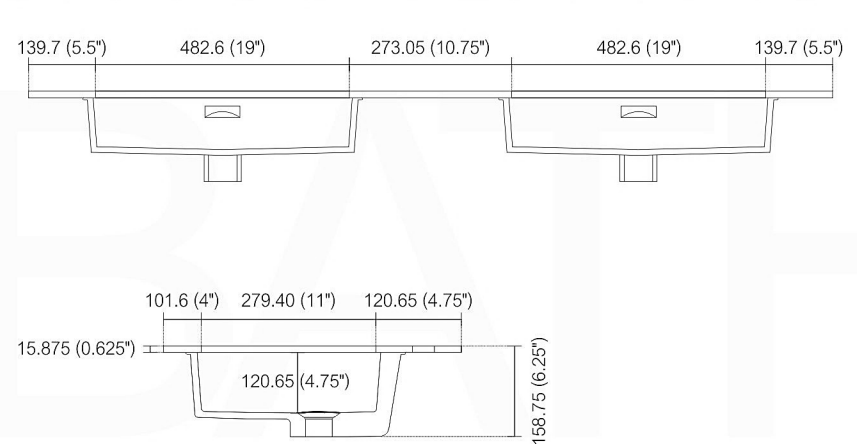
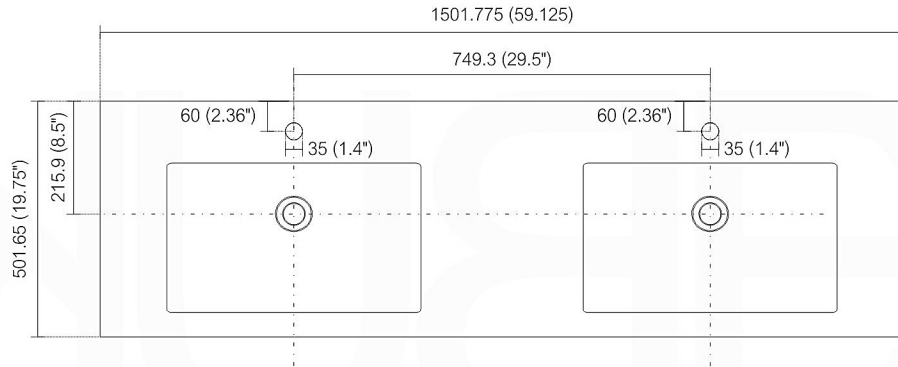
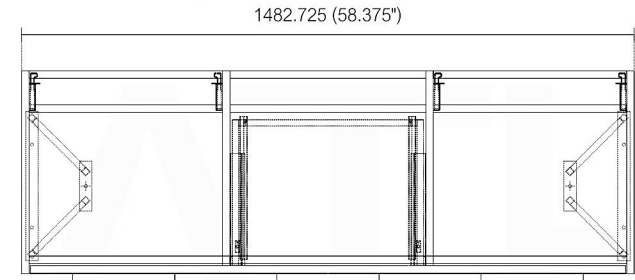

All rights reserved. The authors retain all copyrights in any text, graphic images, and photos in this book. No part of this publication may be reproduced or transmitted in any form or by any means, electronic or mechanical, including photocopying, recording, or any information storage and retrieval system, without permission in writing from the authors.

BOSCO MIRROR W/ SHELVE

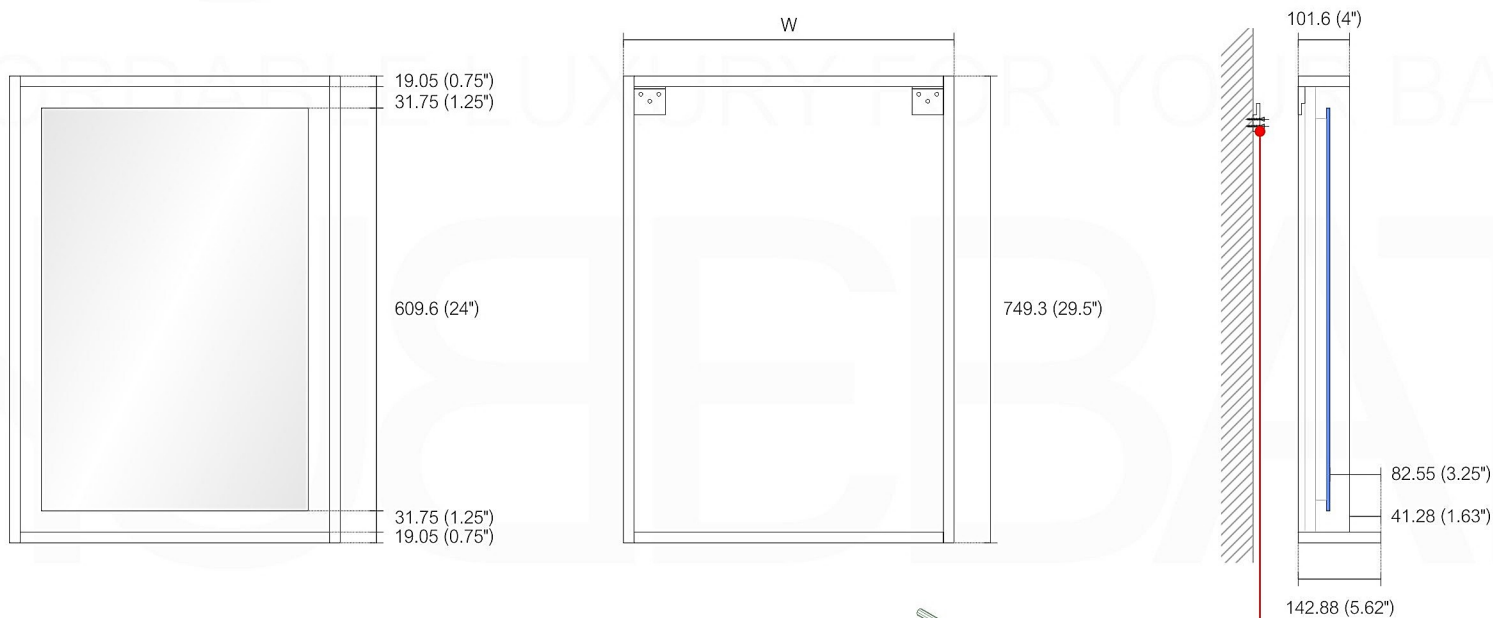

- . Align and level mounting clips according to horizontally reinforced studs and desired MIRROR height.
- . Install mounting Clips to the wall.
- . Carefully lift the cabinet and mount onto the mounting clips.

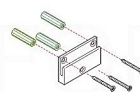

SKU	Dimensions:	width	depth	height	Dimensions:	width	depth	height
KB24-M	inches	23.6"	5.62"	29.5"	mm	600	142.88	749.3
KB30-M		28.7"	5.62"	29.5"		730	142.88	749.3
KB36-M		34.65"	5.62"	29.5"		880	142.88	749.3
KB48-M		47.48"	5.62"	29.5"		1206	142.88	749.3
KB60D-M		58.27"	5.62"	29.5"		1480	142.88	749.3

NOTE: DIMENSIONS AND TECHNICAL DETAILS ARE SUBJECT TO CHANGE WITHOUT NOTICE

SQUARE UNDERMOUNT SINK KB21

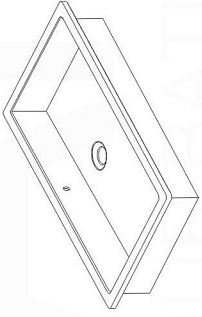

TOP ELEVATION

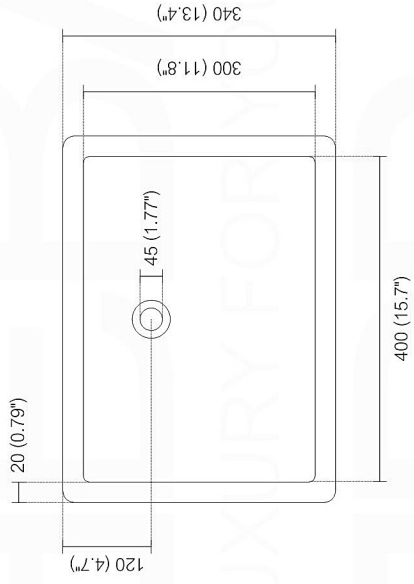

FRONT ELEVATION

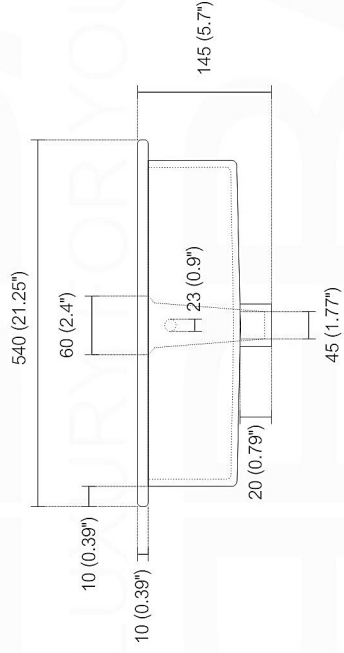

SIDE ELEVATION

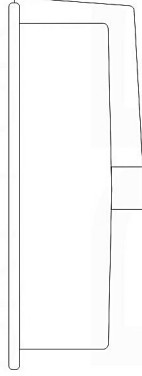

UNDERMOUNT SINK - INSTALLATION

1. Unpack the new sink and check the contents of the materials supplied.

2. Clean the underside of the countertop and the rim of the sink.

3. Use actual basin as your template. Place it upside down on countertop by tracing edge of basin. Be sure to allow clearance for faucet and other accessories or fixtures.

4. Generously apply 100% silicone sealant around the rim.

5. Position the sink under the opening and install the clamps.

* Use level to make sure that the basin is sitting level in all directions , front to back and side to side, while pressing down to seal. Carefully remove any excess silicone.
* Leave to cure for 24 hours before removing the clamps.

Note: Sink style, shape, cutout on top may vary from the picture above. Instructional purposes only.

1

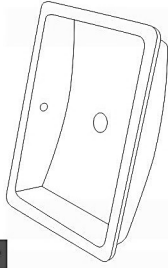

2

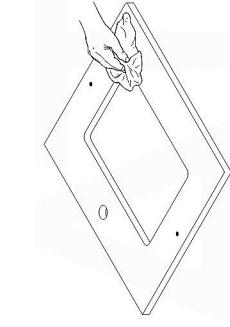
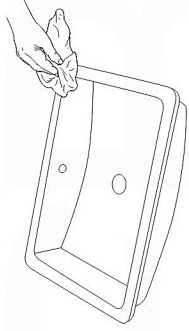

↑ 2x Screws

↖ 2x Clamps

3

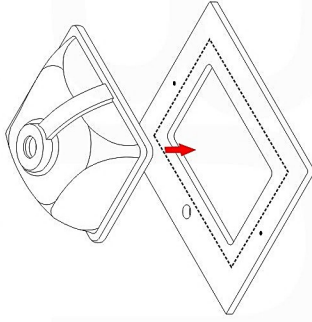

4

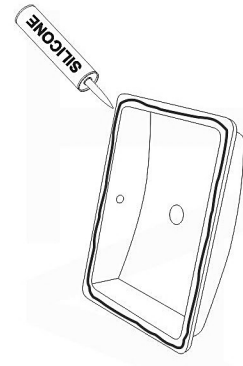
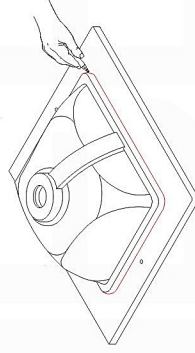

5

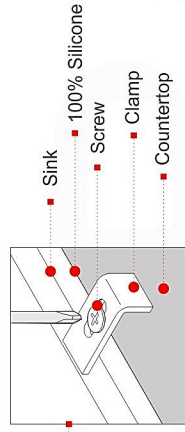
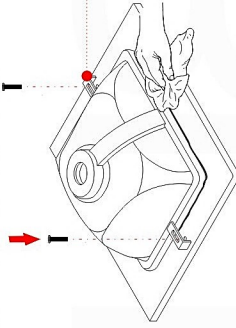

How to Install a Bosco Vanity | Remove / Install Drawers | Adjust Doors INSTALLATION GUIDE

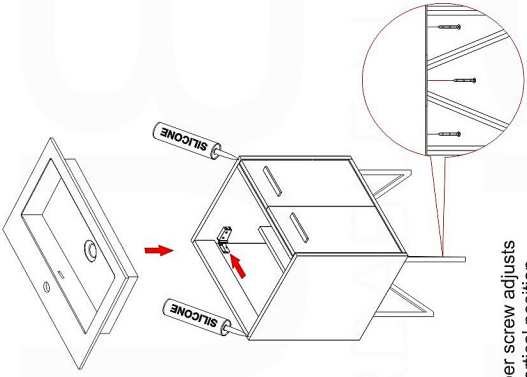

1. Determine your vanity placement and mark the area on the wall where it will be installed.
2. Locate and mark the location of the studs to which you will fasten your vanity. You can find studs by listening for a solid sound as you knock on the wall or by using a stud finder.
3. If your vanity cabinet has a solid back, mark and drill holes to accommodate drain pipes and supply pipes as necessary.
4. Mark the location of each of the wall mounting plates ensuring that they are positioned inside the sidewalls of the vanity unit.
5. Place the vanity in the installation location. Verify that the vanity cabinet is level. If the vanity is not level, use vanity feet (if included) or wooden shims to adjust as necessary.
6. Install the integral sink/vanity top by applying a dot of silicone sealant on the corners of the vanity. Position the vanity top onto the vanity and press firmly into place. Wipe away any excess sealant with a damp cloth.

Note: We recommend consulting professional help if you are unfamiliar with installing bathroom vanities and/or plumbing.

Upper screw adjusts vertical position

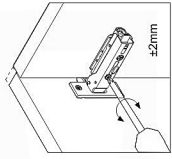
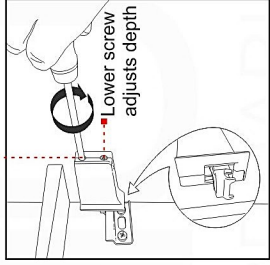

Side adjustment

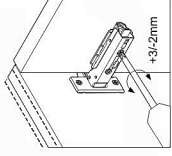

Depth adjustment via worm gear

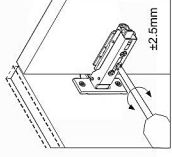

Depth adjustment via worm gear

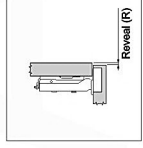

Full Overlay/Overlay Door

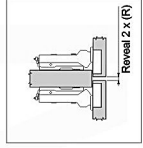

Half Overlay Door

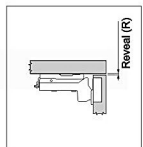

Inset Door

REMOVE DRAWERS

(Locate the screws on the bottom of the drawer)

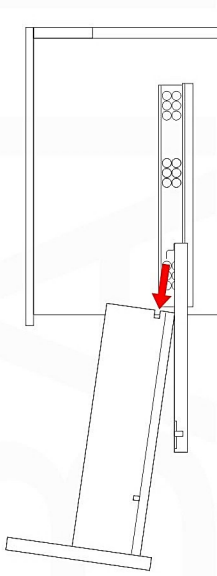
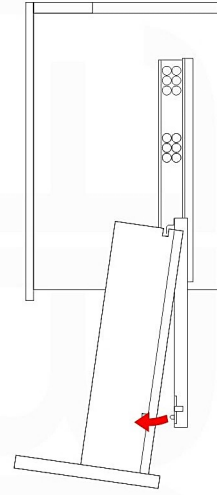
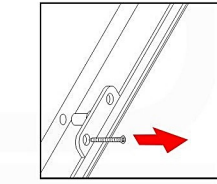

INSTALL DRAWERS

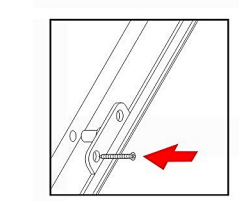
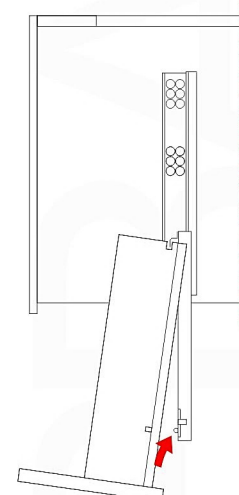
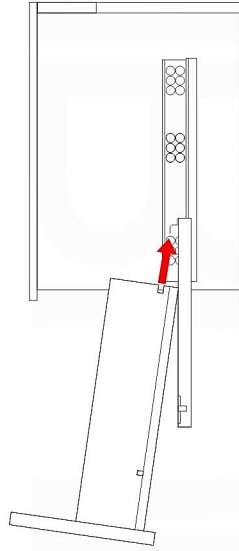

Pop-Up / P-trap Installation Instructions
INSTALLATION GUIDE

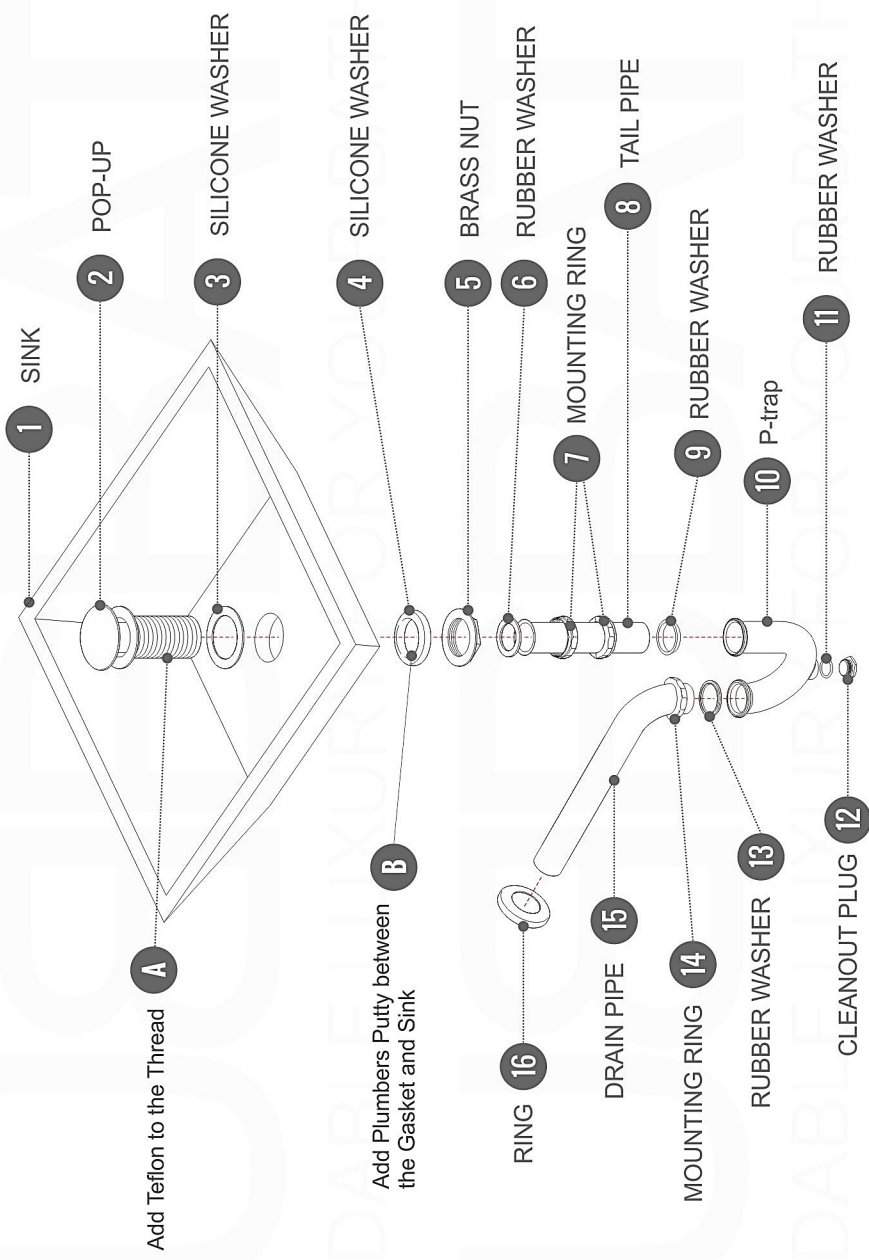

FOR SINKS WITHOUT OVERFLOW
#SKU: P101N / P102N

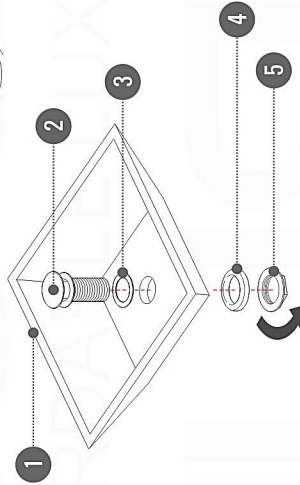
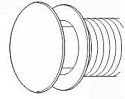

OR

FOR SINKS WITHOUT OVERFLOW
#SKU: P101 / P102

