

Scan and Login website
for more information



TIP BOOK



Contents

Periodontal treatment device

Model		Page
P50L		1
P50R		2
P52		3
P53L		4
P53R		5

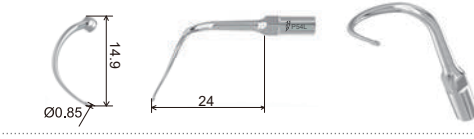
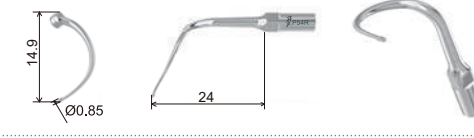
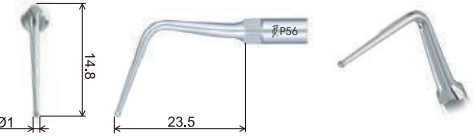
Model		Dimensions Unit: mm	Page
P54L			6
P54R			7
P56			8

Periodontal treatment device

Model		Page
P58		9
P59		10
P80		11
P90		12
P94		13

Dimensions Unit: mm

Model		Page
P95		14
P96L		15
P96R		16
Scaling		
G1		17
G2		18



Scaling

Model		Page
G3		19
G4		20
G5		21
G6		22
G7		23
G8		24

Dimensions Unit: mm

Model		Page
G9		25
G10		26
G11		27
G12		28
G20		29
G21		30

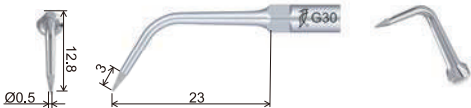
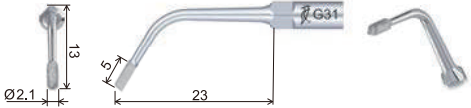

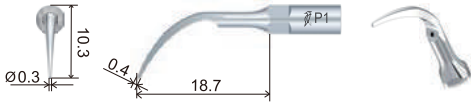

Cavity preparation

Model		Page
G30		31
G31		32
G32		33
G33		34

Periodontics

P1		35
----	---	----

Dimensions Unit: mm

Model		Page
P2L		36
P2LD		37
P2R		38
P2RD		39
P3		40

Periodontics

Model

Page

P3L

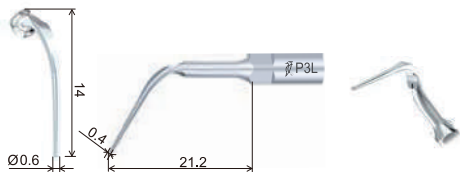

41

P3R

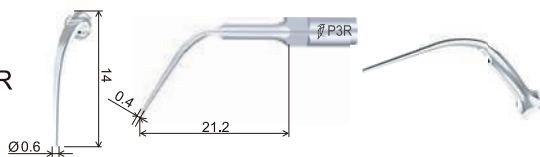

42

P3D



43

P4

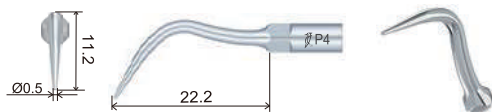

44

P5

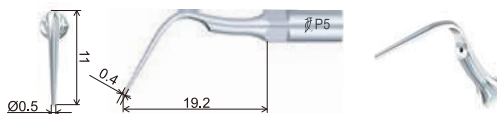

45

Dimensions Unit: mm

Model

Page

P6



46

P7

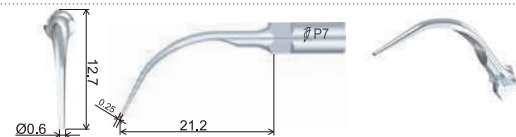

47

P8

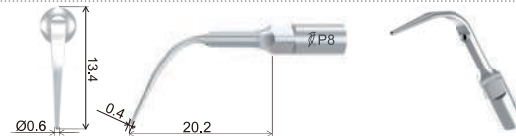

48

P10

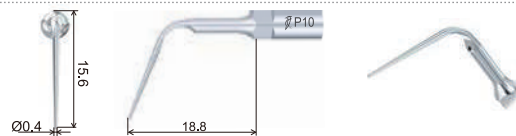

49

P11

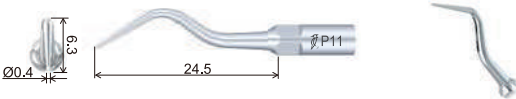



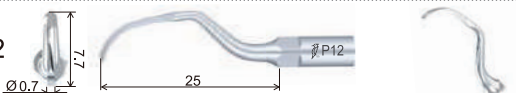

50

P12





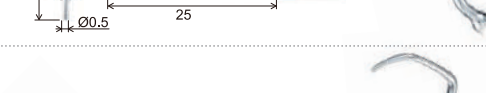
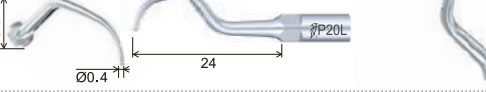

51

Periodontics

Model		Page
P14L		52
P14R		53
P18		54
P20		55
P20L		56
P20R		57

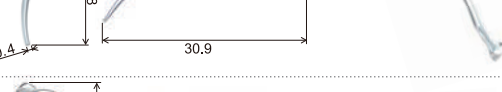
Dimensions Unit: mm

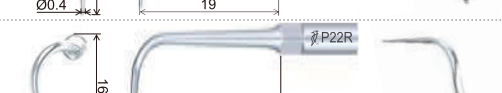
Model		Page
P21L		58
P21R		59
P22L		60
P22R		61
P33		62

Periodontics

Model		Page
PD40		63
PD41		64
PD42		65
PD43L		66
PD43R		67

Endodontics

Model		Dimensions Unit: mm	Page
E1			68
E2			69
E3			70
E3D			71
ED3D			72

Endodontics

Model	Page
 <p>E4</p> <p>25.5 22 26.5 Ø0.4</p>	73
 <p>E4D</p> <p>25.5 15 26.5 Ø0.6</p>	74
 <p>E5</p> <p>23.2 91 20.6 Ø0.4</p>	75

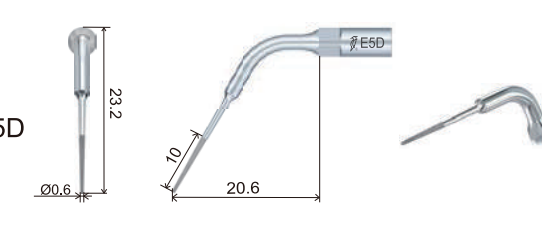
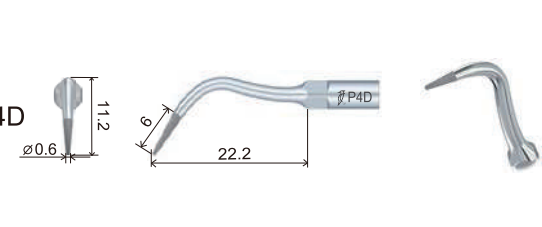
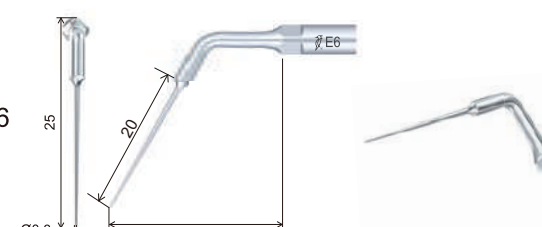
Model	Page
 <p>E5D</p> <p>23.2 10 20.6 Ø0.6</p>	76
 <p>P4D</p> <p>11.2 9 22.2 Ø0.6</p>	77
 <p>E6</p> <p>25 20 23.8 Ø0.3</p>	78

Endodontics

Model	Page
<p>E7</p>	79
<p>E8</p>	80
<p>E9</p>	81
<p>E10</p>	82
<p>E10D</p>	83

Dimensions Unit: mm

Model	Page
<p>E11</p>	84
<p>E11D</p>	85
<p>E12D</p>	86
<p>E14</p>	87

Endodontics

Model	Dimensions (mm)	Page
E14D		88
E15		89
E15D		90
ED17		91

Dimensions Unit: mm

Model	Dimensions (mm)	Page
ED18		92
ED19D		93
ED20D		94
ED21LD		95
ED21RD		96

Endodontics

Model		Page
ED22D		97
ED23D		98
ED24D		99
ED25LD		100
ED25RD		101

Model		Page
E60		102
E62		103
E66		104

Dimensions Unit: mm



Cavity preparation

Model		Page
SB1		105
SB2		106
SB3		107
SBL		108
SBR		109

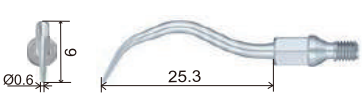
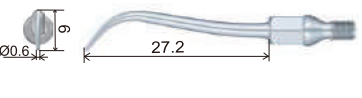
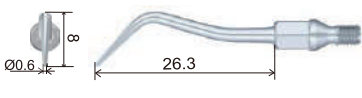
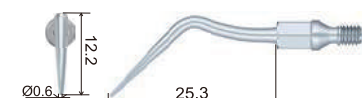

Dimensions Unit: mm

Model		Page
SB4		110
SB5		111
SB6		112
SB7L		113
SB7R		114

Scaling

Model		Page
GK1		115
GK2		116
GK3		117
GK4		118
GK5		119
GK6		120

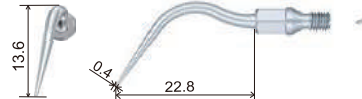
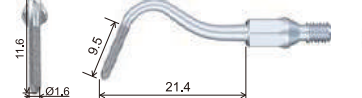
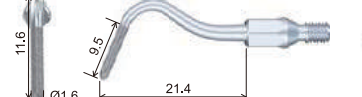
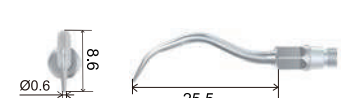
Dimensions Unit: mm

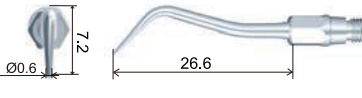
Model		Page
GK7		121
GK20		122
GK21		123
GK60		124
GK61		125
GK62		126

Scaling

Model	Page
<p>GC1</p>	127
<p>GC2</p>	128

Periodontics

<p>PC1</p>	129
<p>PC60</p>	130
<p>PC61</p>	131

Periodontics

Dimensions Unit: mm

Model	Page
<p>PC62</p>	132

Scaling

<p>A1</p>	133
<p>A2</p>	134

Bone surgery

Model		Page
US1		135
US1L		136
US1R		137
US2		138
US3		139

Dimensions Unit: mm

Model		Page
US4		140
US5		141
US6		142
US13		143
US21		144
US25		145

Sinus lifting

Model		Page
UL1		146
UL2		147
UL3		148
UL4		149
UL5		150

Dimensions Unit: mm

Model		Page
UL8		151

Endodontics

UE1		152
UE2		153
UE3		154
UE4		155

Exelcymosis

Model		Page
UC1		156
UC2		157
UC3		158
UC6		159
UC7		160

Implantaion

Dimensions Unit: mm

Model		Page
UI1		161
UI2		162
UI7		163
UI8		164
UI9		165

Periodontal surgery

Model		Page
UP1		166
UP2		167
UP3		168
UP4		169
UP5		170

Dimensions Unit: mm

Model		Page
UP6		171
UP7		172

**SPOILING YOU
SO MUCH!**



Ultrasonic scaler Tip

MODE: P
POWER

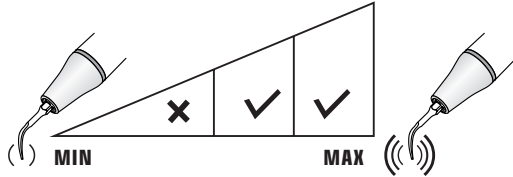

Meaning of the above symbols:

Mode X indicates that the tip should be used in X mode of the scaler.

Power

The first grid indicates that the power is 0-30% of the power in the X mode of the scaler.

The second grid indicates that the power is 30% -60% of the power in the X mode of the scaler.

The third grid indicates that the power is 60% -100% of the power in the X mode of the scaler.

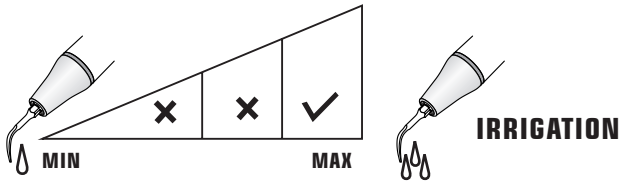

Meaning of the above symbols:

Water volume

The first grid indicates that the water volume is 0-30%.

The second grid indicates that the water volume is 30% -60%.

The third grid indicates that the water volume is 60% -100%.

P50L

Volume of water: Ensure the cooling water reach the end of the tip.

Functional Description: Explore subgingival calculus, root planing and subgingival scaling.

Applicable area: Teeth adjacent part

Operation method: The tip is perpendicular to the long axis of the tooth, The front or back 2mm tip needle part adapt the tooth surface. Move the tip up and down.

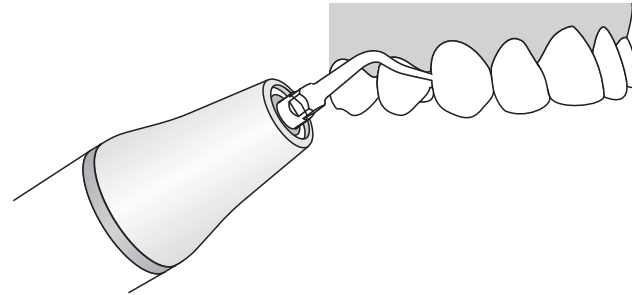

Demo Video

MODE: P
POWER

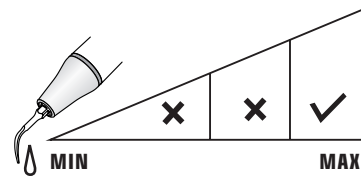
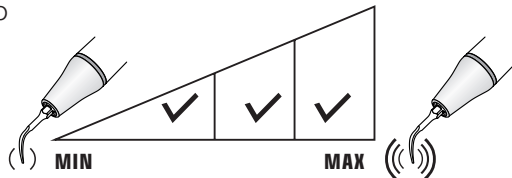

IRRIGATION



P50R

Volume of water: Ensure the cooling water reach the end of the tip.

Functional Description: Explore subgingival calculus, root planing and subgingival scaling.

Applicable area: Teeth adjacent part

Operation method: The tip is perpendicular to the long axis of the tooth, The front or back 2mm tip needle part adapt the tooth surface. Move the tip up and down.

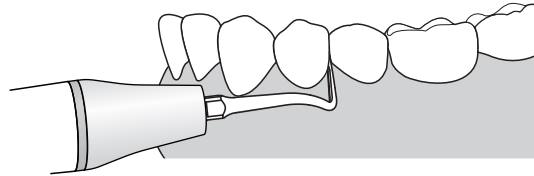

Demo Video

MODE: P
POWER

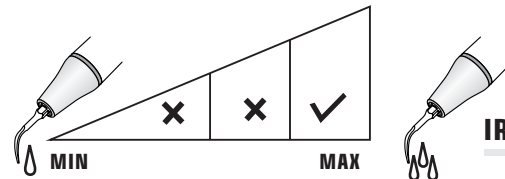
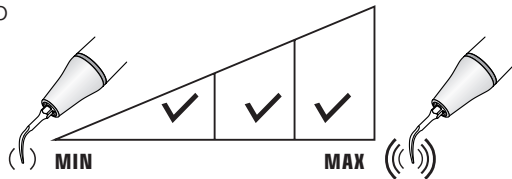

IRRIGATION

P52

Volume of water: Ensure the cooling water reach the end of the tip

Functional Description: For gingival scaling

Applicable area: All teeth buccal and lingual site

Operation method: The tip is parallel to the long axis of the tooth, and ensure the 2 mm right or left tip middle site adapt the tooth surface. Move the tip front and back.

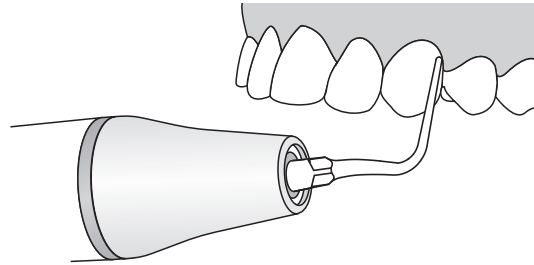
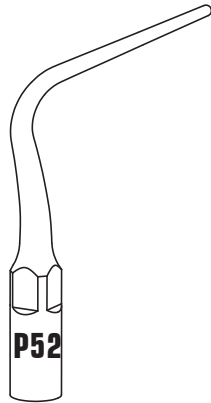

Demo Video

MODE: P
POWER

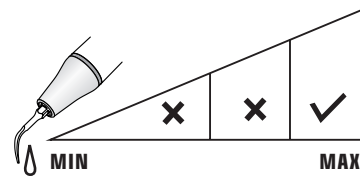
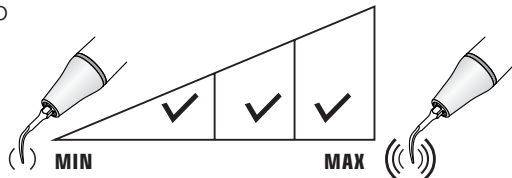

IRRIGATION

P53L

Volume of water: Ensure the cooling water reach the end of the tip.

Functional Description: Explore subgingival calculus, root planing and subgingival scaling.

Applicable area: Teeth adjacent part

Operation method: The tip is perpendicular to the long axis of the tooth, The front or back 2mm tip needle part adapt the tooth surface. Move the tip up and down.

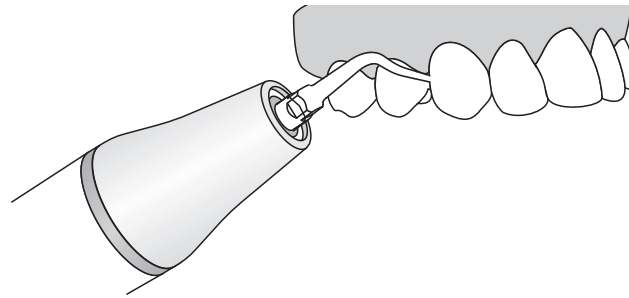
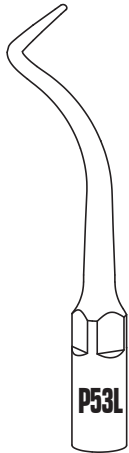

**MODE: P
POWER**

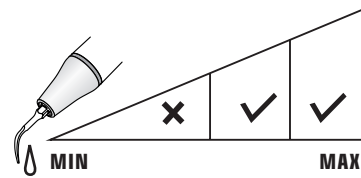
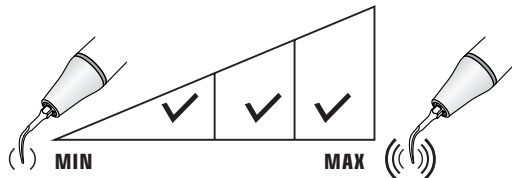

IRRIGATION

P53R

Volume of water: Ensure the cooling water reach the end of the tip.

Functional Description: Explore subgingival calculus, root planing and subgingival scaling.

Applicable area: Teeth adjacent part

Operation method: The tip is perpendicular to the long axis of the tooth, The front or back 2mm tip needle part adapt the tooth surface. Move the tip up and down.

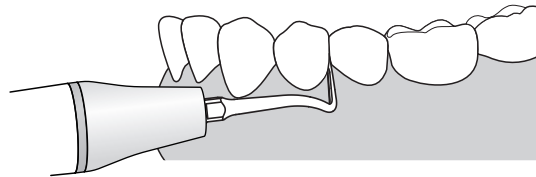
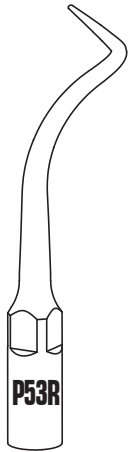

**MODE: P
POWER**

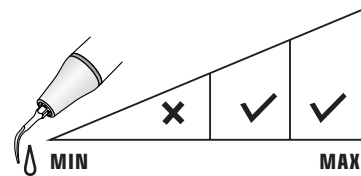
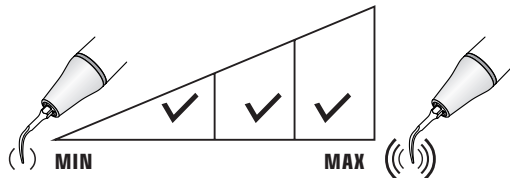

IRRIGATION

P54L

Water volume control: Ensure that the cooling water reaches the end of the tip

Function: For the treatment of root bifurcation area.

Applicable area: Root bifurcation area

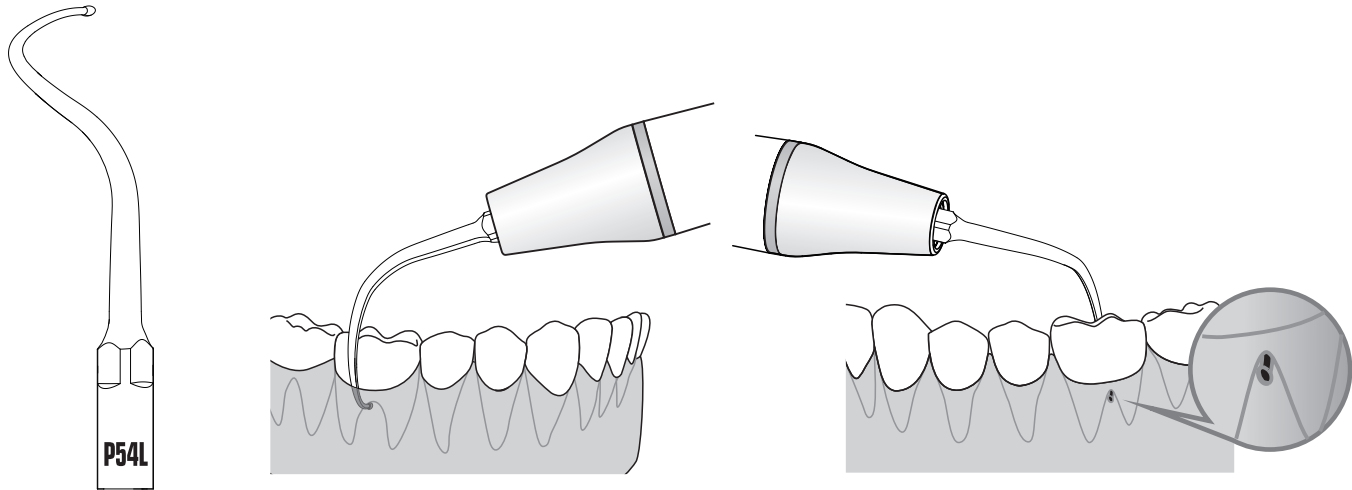

MODE: P
POWER

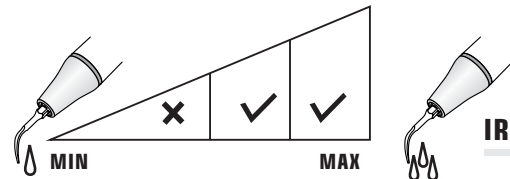
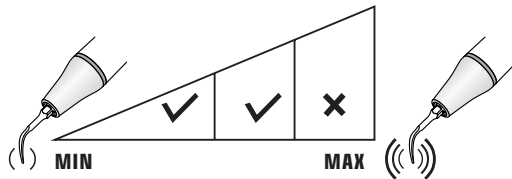

IRRIGATION

P54R

Water volume control: Ensure that the cooling water reaches the end of the tip

Function: For the treatment of root bifurcation area.

Applicable area: Root bifurcation area

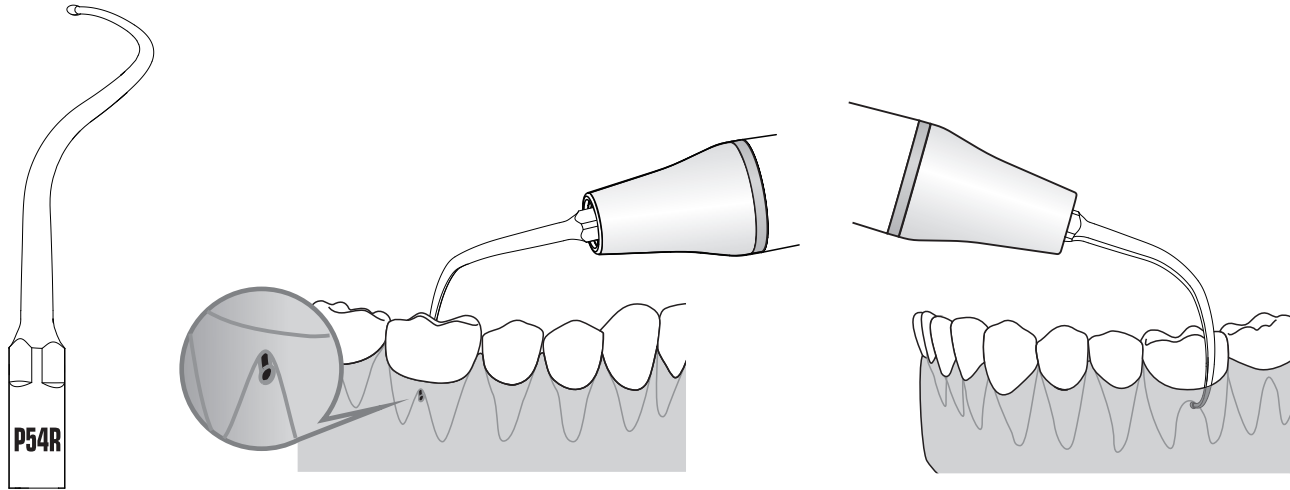

**MODE: P
POWER**

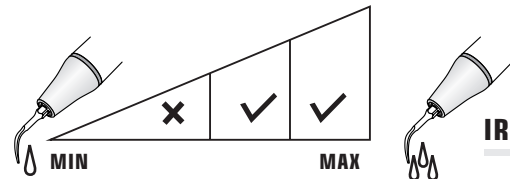
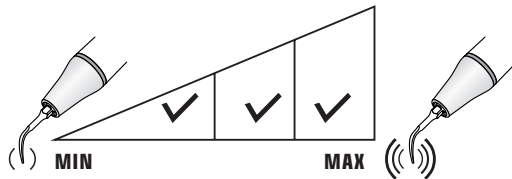

IRRIGATION

P56

Volume of water: Ensure the cooling water reach the end of the tip

Functional Description: Used for gingival large stones and dental plaque

Applicable area: All teeth buccal and lingual site.

Operation method: The tip is parallel to the long axis of the tooth. and ensure the 2 mm right or left tip niddle site adapt the tooth surface. Move the tip front and back.

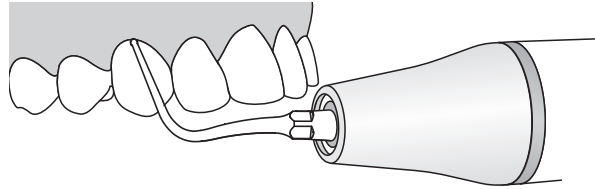
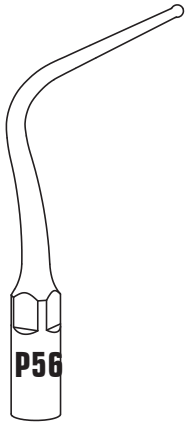

MODE: P
POWER

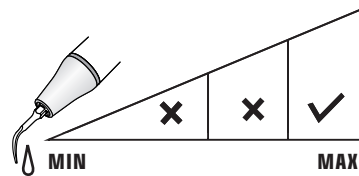
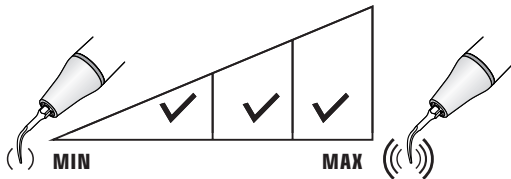

IRRIGATION

P58

Water volume control: Ensure that the cooling water reaches the end of the tip.

Function: For the treatment of root bifurcation, removal of supragingival large calculus and plaque.

Applicable area: root bifurcation area, labial (buccal) surface and lingual (palatal) surface of all teeth.

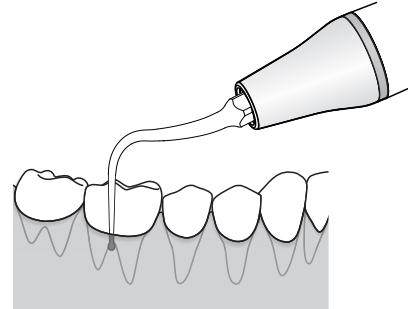
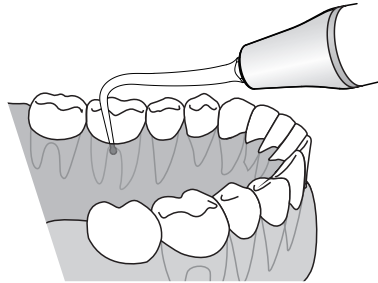

**MODE: P
POWER**

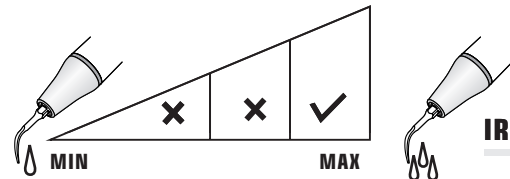
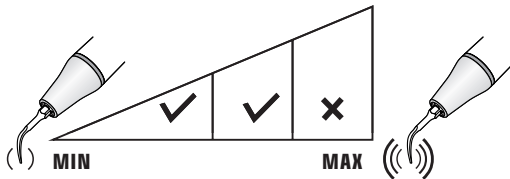

IRRIGATION

P59

Volume of water: Ensure the cooling water reach the end of the tip

Functional Description: For subgingival calculus probing, subgingival scaling and root planing

Applicable area: All teeth buccal and lingual site

Operation method: The tip is parallel to the long axis of the tooth. and ensure the 2 mm right or left tip middle site adapt the tooth surface. Move the tip front and back.

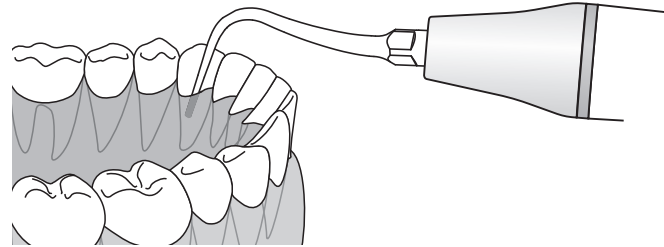

Demo Video

MODE: P

POWER

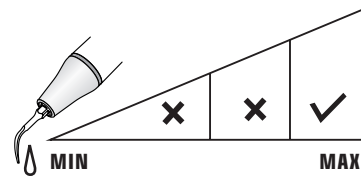
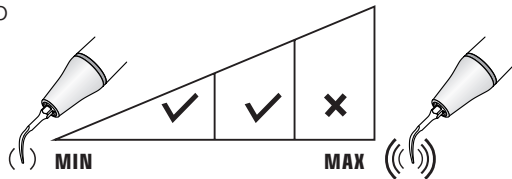

IRRIGATION

P80

Function: For subgingival irrigation. It is mainly used to rinse out the residue after the subgingival treatment.

Features: For non-invasive irrigation. The water outlet is at about 1mm from the tip, which is convenient for subgingival flushing at different areas and angles.

Use: Used in P mode of PT5. Recommended power level: level 1~5 (Please do not exceed the recommended maximum power level. Otherwise instrument fracture is easy to happen).

Note:

(1) The tip is mainly used for subgingival irrigation, and should not be used for scraping solid objects as much as possible to prevent the tip from being worn too fast and shortening the service life.

(2) In order to ensure the safety, it is recommended to firstly perform the external debugging, select debugging water volume under power level 1, ensure the water output is normal, and adjust the power within the range of power level limit.

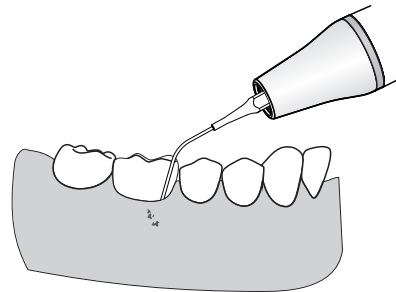
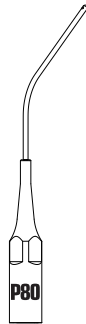

MODE: P
POWER

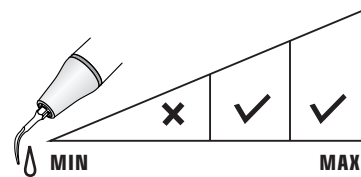
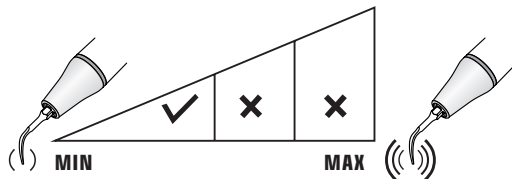

IRRIGATION

P90

Volume of water: Ensure the cooling water reach the end of the tip

Functional Description: Used for gingival large stones and dental plaque

Applicable area: All teeth buccal and lingual site of dental implant or prosthesis.

Operation method: The tip is parallel to the long axis of the tooth, and ensure the 2 mm right or left tip middle site adapt the tooth surface. Move the tip front and back.

Warn: Please ensure that there is water coming out from the handpiece to avoid damage to the tip

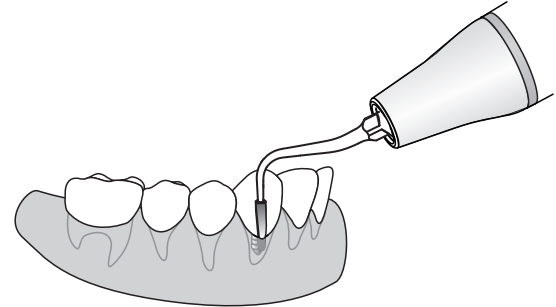
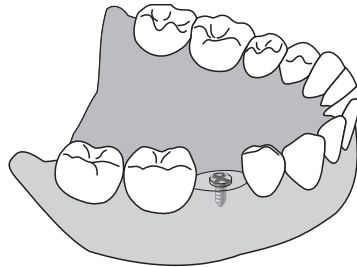
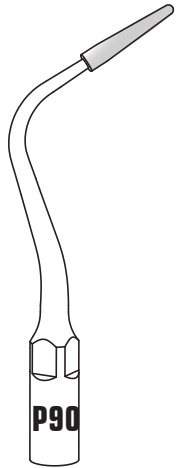

MODE: P
POWER

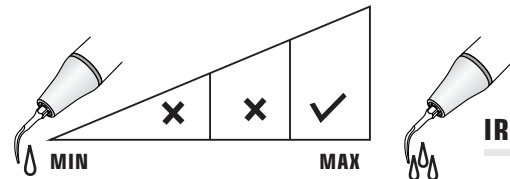
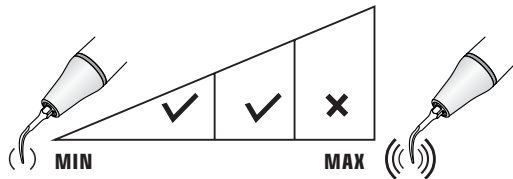

IRRIGATION

P94

Function: Cleaning and maintenance of implant

Size: Plastic head is of 15mm length

Features: The tip is of a slender hook shape, making it easier for subgingival cleaning and maintenance.

Use:

- a. Used in P mode of Periodontal Treatment Device. Recommended power level: level 1~3.
- b. Used in P mode of U600. Recommended power level: level 1
- c. Used in P mode of U6. Recommended power level: level 1~3.

Note:

- (1) The plastic part is made of PEEK material which can be disinfected under high temperature and high pressure, the higher the power, the easier it is to wear;
- (2) Avoid the tip stuck in the gap of the tooth during operation to avoid breaking the tip.

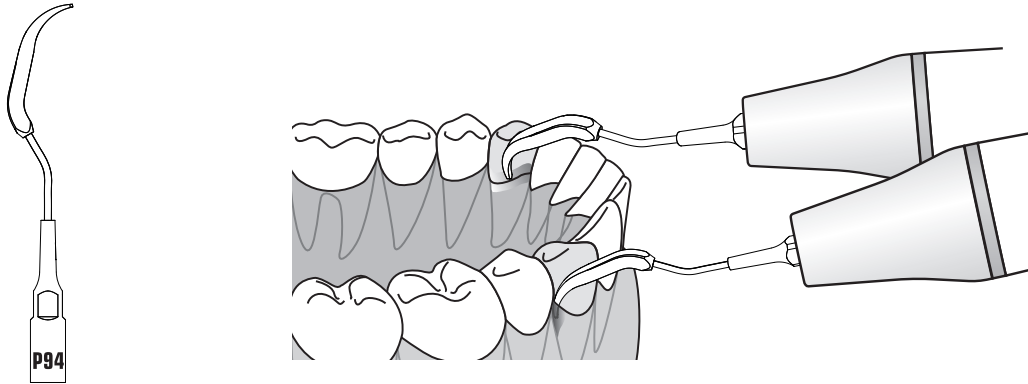

MODE: P
POWER

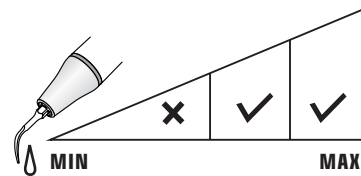
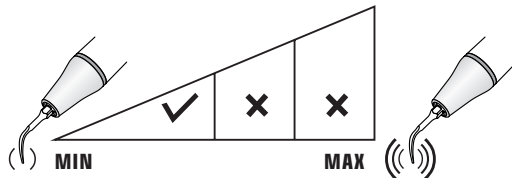

IRRIGATION

P95

Function: Cleaning and maintenance of implant

Size: Plastic head is of 19mm length

Features: The tip is of a slender hook shape, making it easier for subgingival cleaning and maintenance.

Use:

- a. Used in P mode of Periodontal Treatment Device. Recommended power level: level 1~6.
- b. Used in P mode of U600. Recommended power level: level 1~3
- c. Used in P mode of U6. Recommended power level: level 1~6.

Note:

- (1) The plastic part is made of PEEK material which can be disinfected under high temperature and high pressure, the higher the power, the easier it is to wear;
- (2) Avoid the tip stuck in the gap of the tooth during operation to avoid breaking the tip.

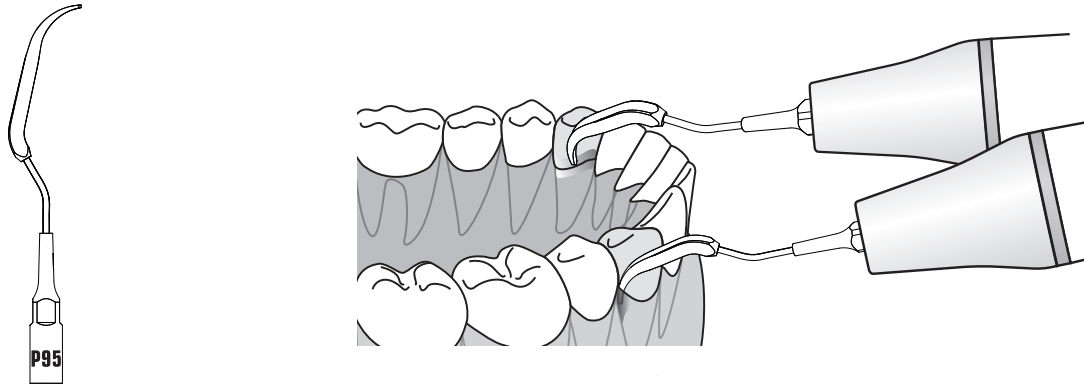

MODE: P
POWER

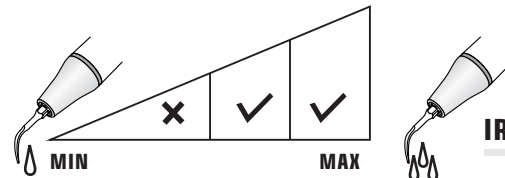
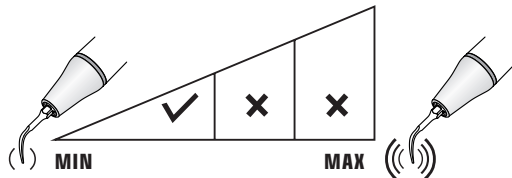

IRRIGATION

Special design for periodontal treatment device

P96L

Function: used for cleaning and maintenance of dental implants. Plastic head length: 21mm.

Feature: The tip is of a slender hook shape, making it easier to clean and maintain in subgingival part.

The tip end is twice bent, so it does not touch the adjacent teeth and buccal surface, enabling wider application areas.

Use:

Used in P mode of Periodontal Treatment Device; recommended power level: level 1~5

Used in P mode of U600; recommended power level: level 1~2

Used in P mode of U6; recommended power level: level 1~4

Used in P mode of ordinary scalers; recommended power level: low (level 1~3)

Note:

(1) The plastic part is made of autoclavable PEEK material. The higher the power, the easier it is to wear.

(2) Avoid the tip stuck in the gap of the tooth during operation to prevent breaking the tip.

(3) Before use, please make sure that the water output of handpiece is normal, and then install the tip to avoid damage to the tip.

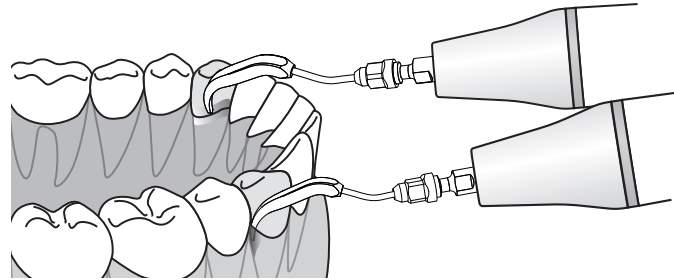
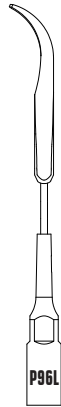

MODE: P
POWER

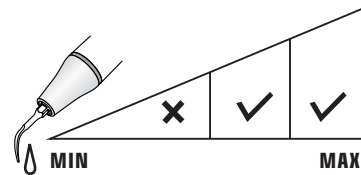
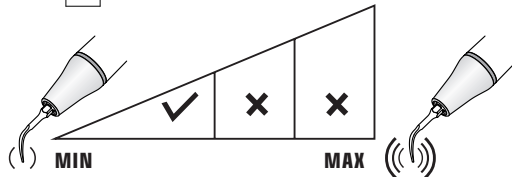

IRRIGATION

P96R

Function: implant maintenance tip installed on PD40 adapter to realize the cleaning and maintenance of dental implants.

Plastic head length: 21mm

Feature: The tip is of a slender hook shape, making it easier to clean and maintain in subgingival part.

The tip end is twice bent, so it does not touch the adjacent teeth and buccal surface, enabling wider application areas.

Use:

Used in P mode of Periodontal Treatment Device; recommended power level: level 1~5

Used in P mode of U600; recommended power level: level 1~2

Used in P mode of U6; recommended power level: level 1~4

Used in P mode of ordinary scalers; recommended power level: low (level 1~3)

Note:

(1) The plastic part is made of autoclavable PEEK material. The higher the power, the easier it is to wear.

(2) Avoid the tip stuck in the gap of the tooth during operation to prevent breaking the tip.

(3) Before use, please make sure that the water output of handpiece is normal, and then install the tip to avoid damage to the tip.

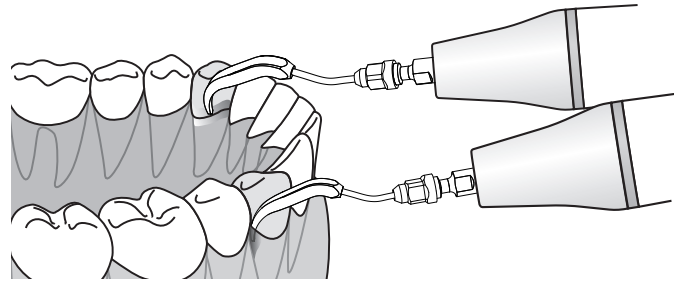
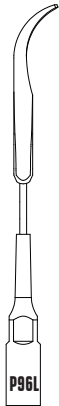

MODE: P
POWER

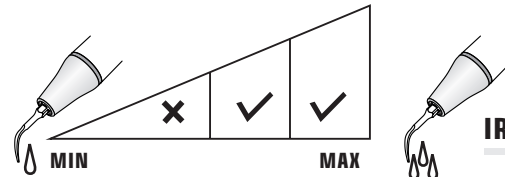
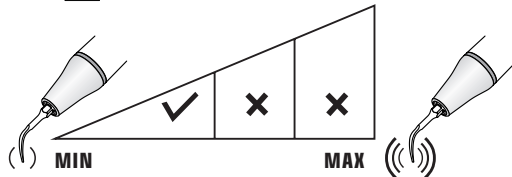

IRRIGATION

G1 (GD1/GS1)

Removal of supragingival deposits in all quadrants.

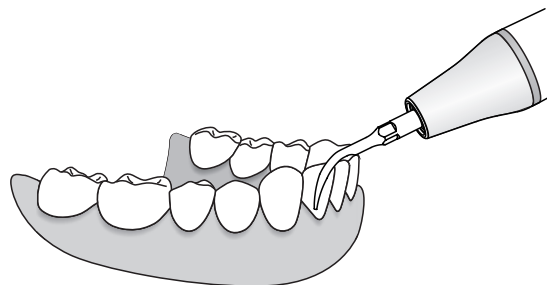
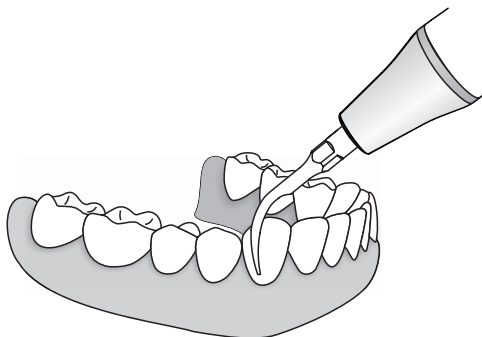
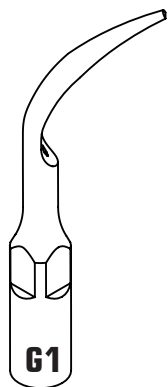

Demo Video

MODE: G
POWER

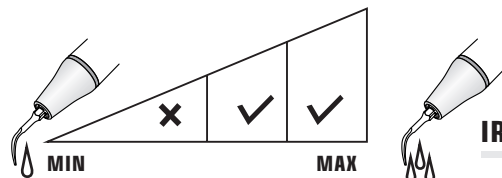
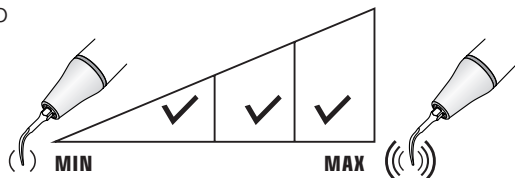

IRRIGATION

G2 (GD2/GS2)

Removal of heavy supragingival deposits.
Apply flat end to surface of teeth.

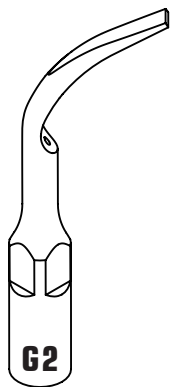

Demo Video

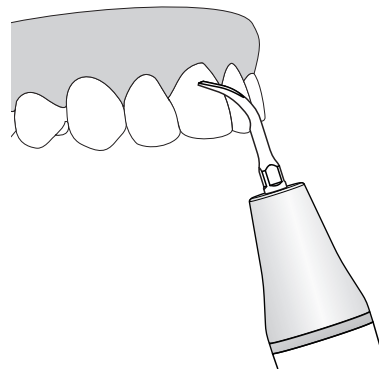
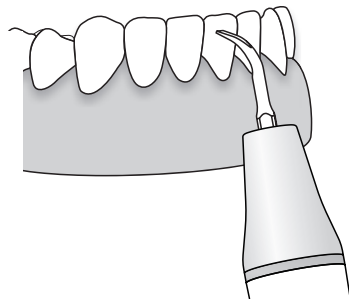

MODE: G
POWER

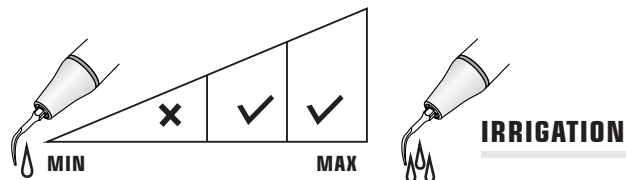
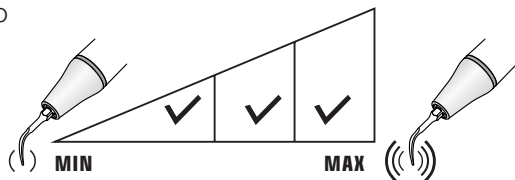

G3 (GD3/GS3)

Removal of supragingival deposits in all quadrants, including the interproximal and sulcus areas.

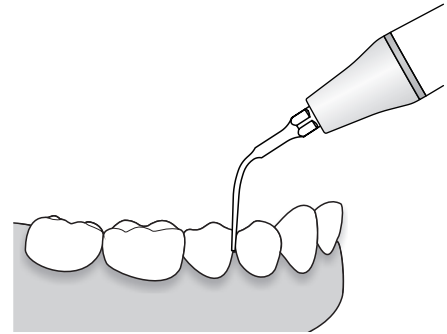
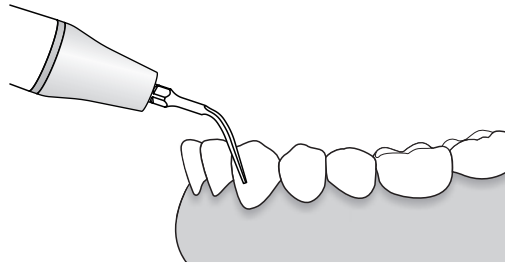
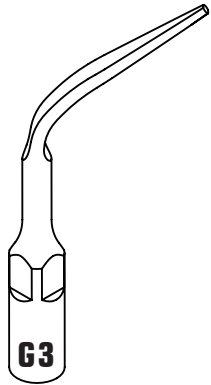

Demo Video

MODE: G
POWER

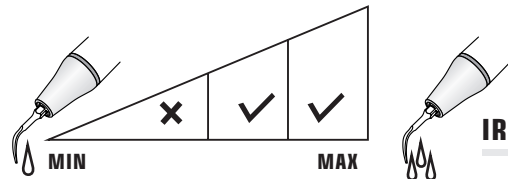
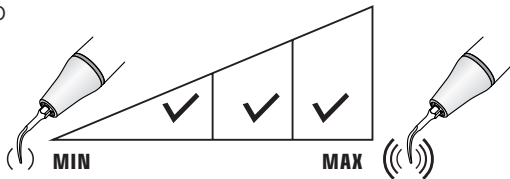

IRRIGATION

G4(GD4/GS4)

Recommended for the treatment of interproximal spaces and for supragingival scaling.

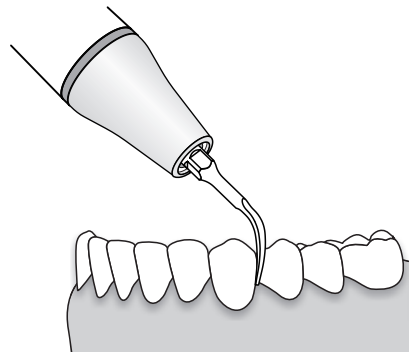
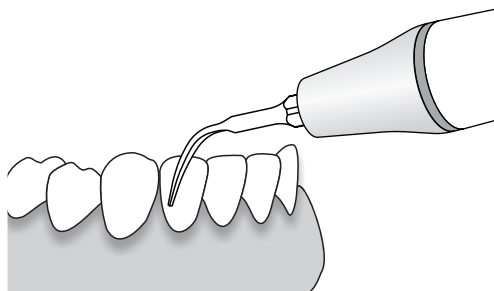
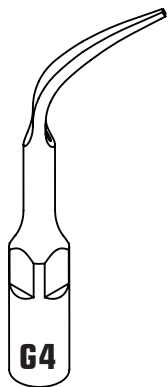

Demo Video

MODE: G

POWER

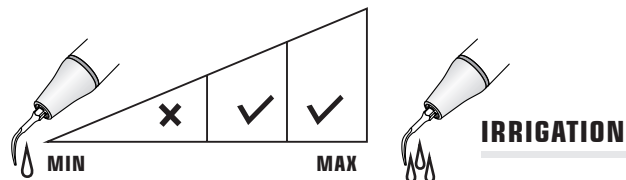
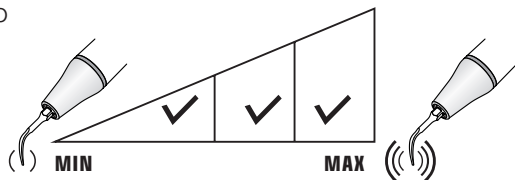

G5 (GD5/GS5)

Recommended for treating simple cases and gross supragingival scaling.

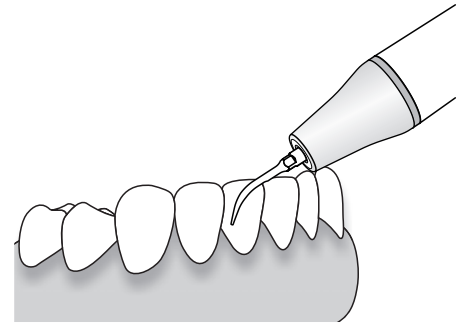
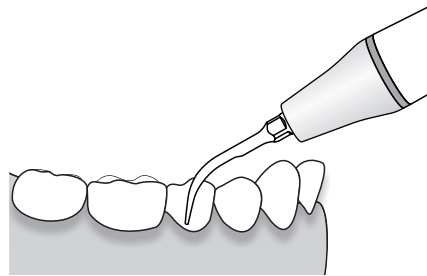
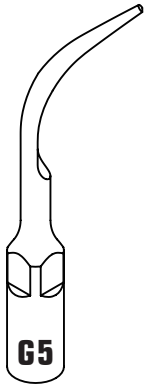

Demo Video

MODE: G
POWER

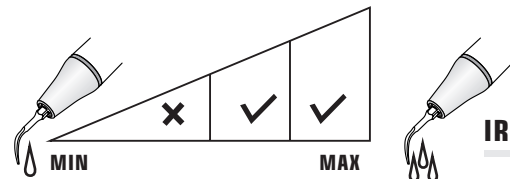
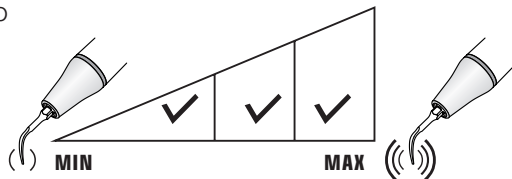

IRRIGATION

G6 (GD6/GS6)

Recommended for removing voluminous supragingival deposits.
Apply flat end to surface of teeth.

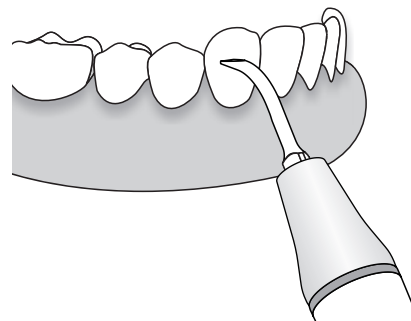
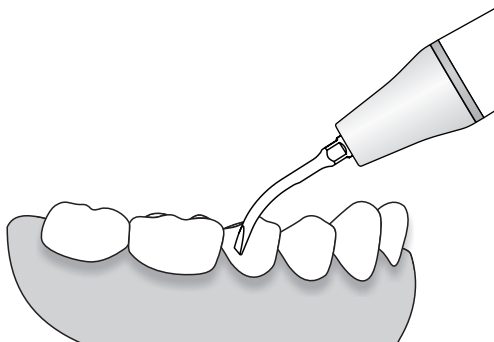
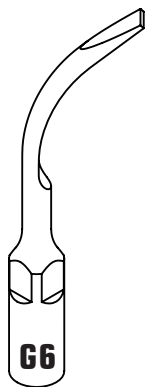

Demo Video

MODE: G
POWER

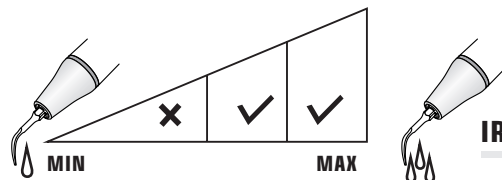
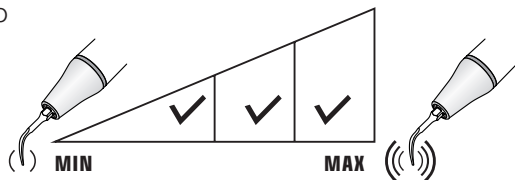

IRRIGATION

G7 (GD7/GS7)

Removal of crowns.

Apply the instrument onto surface and activate. Increase pressure until vibrations can no longer be heard and maintain for few seconds.

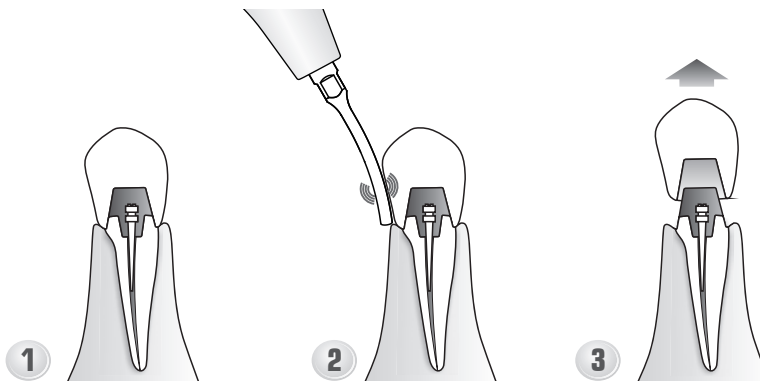
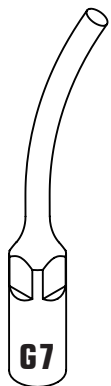

Demo Video

MODE: G
POWER

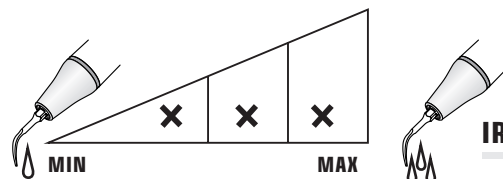
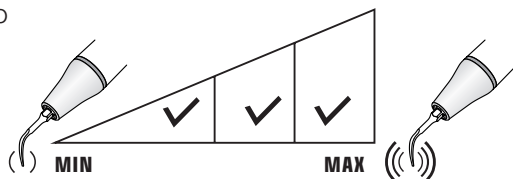

IRRIGATION

G8 (GD8/GS8)

Removal of posts.

Ultrasonic high efficiency for the removal of the difficult prosthetic parts.

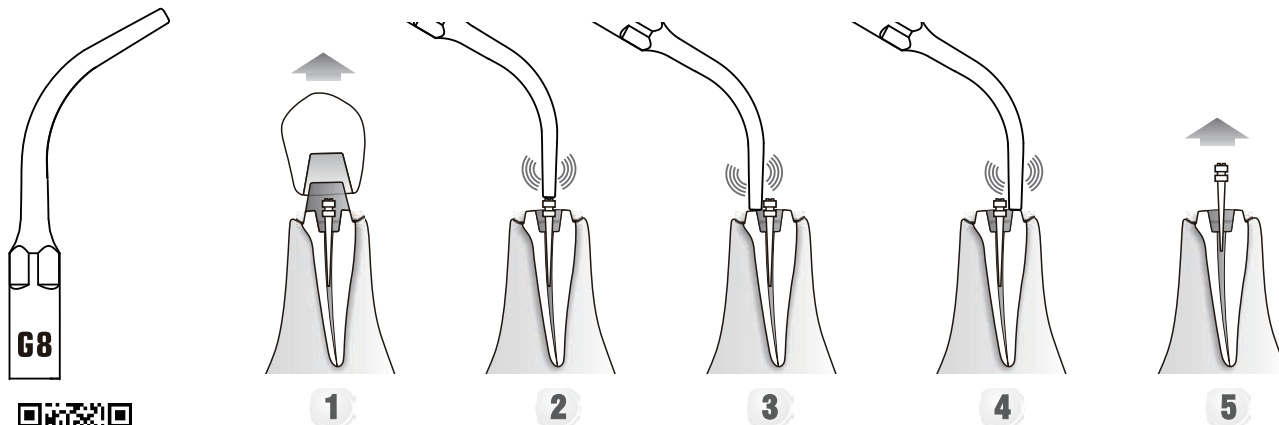

Demo Video

MODE: G

POWER

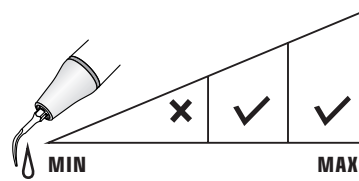
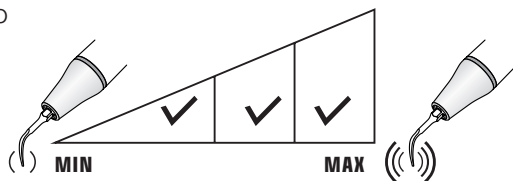

IRRIGATION



G9 (GD9)

Removal of supragingival calculus, interdental calculus and calculus at the neck of the teeth.



Demo Video

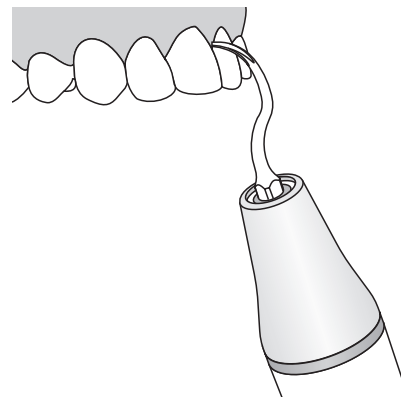
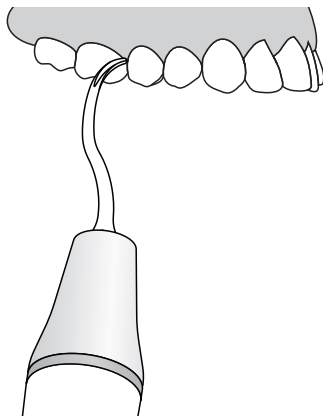

MODE: G
POWER

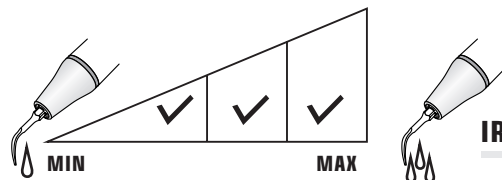
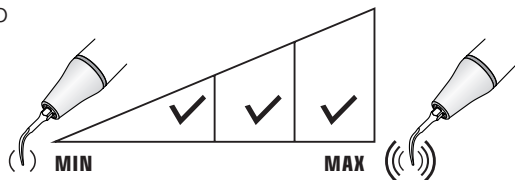

IRRIGATION

G10(GD10)

Removal of supragingival deposits in all quadrants, including the interproximal and sulcus areas.

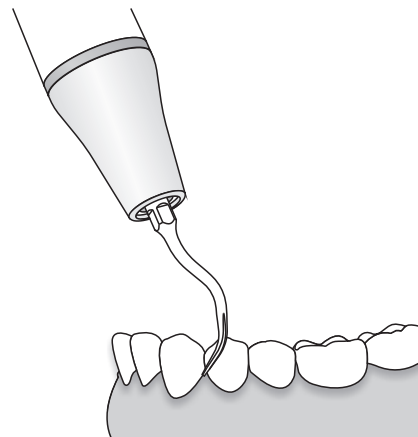
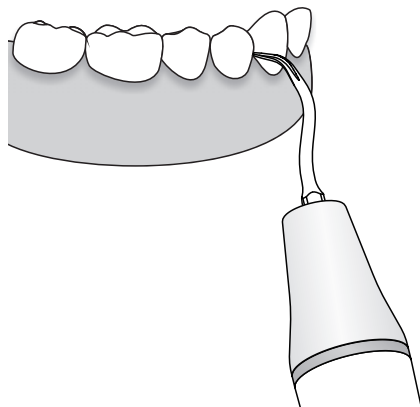

Demo Video

MODE: G
POWER

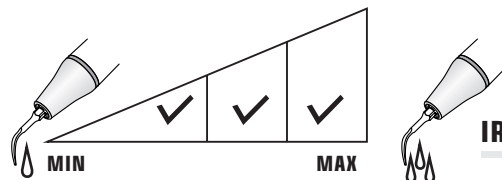
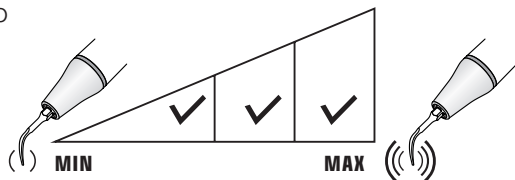

IRRIGATION

G11(GD11/GK11)

Diamond-coated(40 μ m) instrument for polishing the treatment surface of teeth in interproximal areas, without damaging the adjacent teeth during the orthodontics treatment.

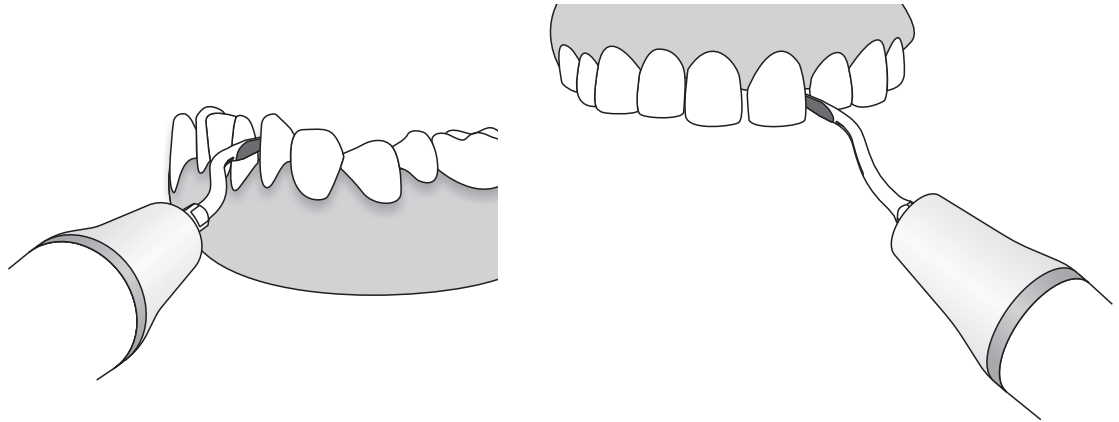

Demo Video

MODE: G
POWER

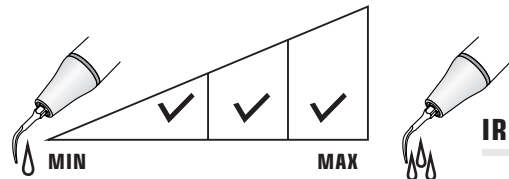
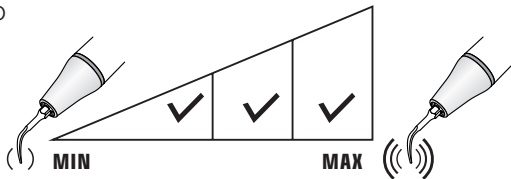

IRRIGATION

G12(GD12)

Removal of large supragingival deposits on the lingual surfaces in all quadrants.

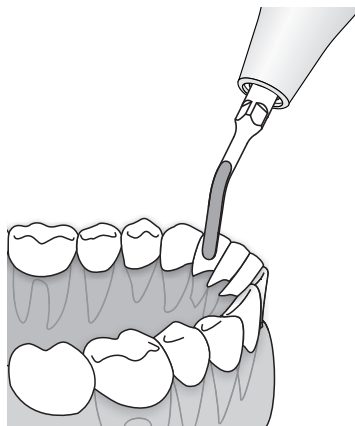
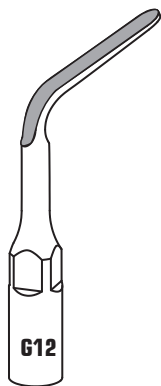

MODE: G
POWER

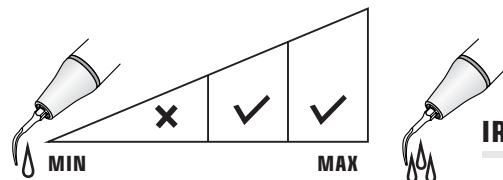
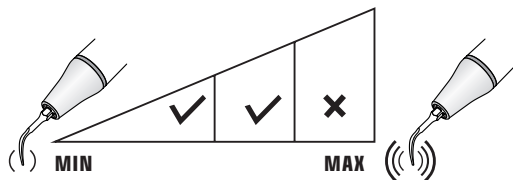

IRRIGATION

G20(GD20)

There are diamonds coated (120um grit) on the head of the tip for dentin abrading.

It's used for "supragingival shoulder" preparation after the completion of the preparation of the "subgingival shoulder" with bur.

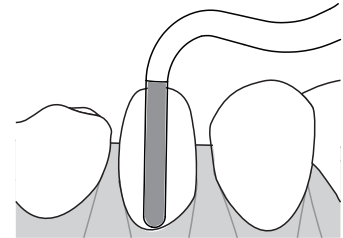
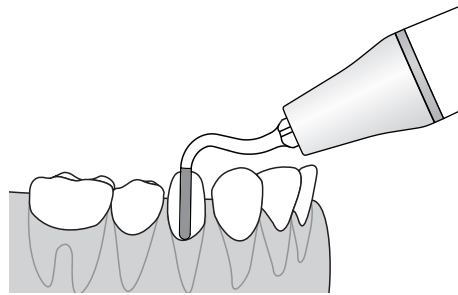

MODE: G
POWER

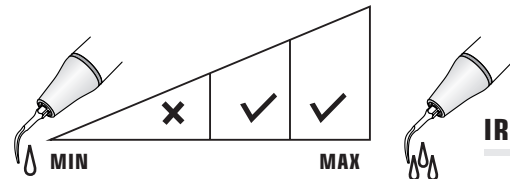
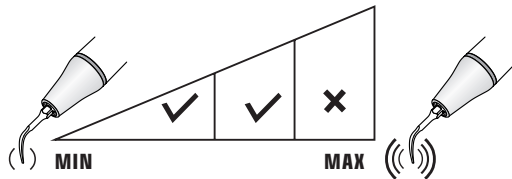

IRRIGATION

G21 (GD21)

There are diamonds coated (50um fine sand) on the head of the tip for dentin abrading, mainly used for polishing of prepared supragingival shoulder and subgingival shoulder.

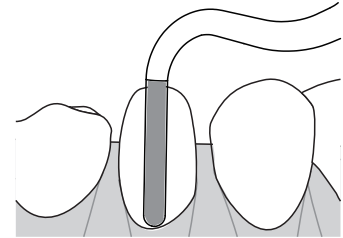
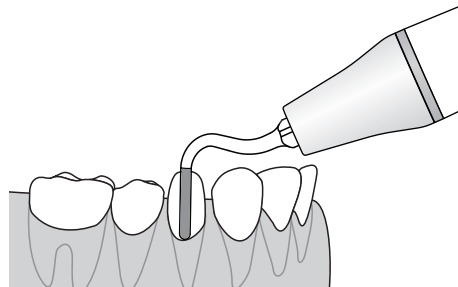

MODE: G
POWER

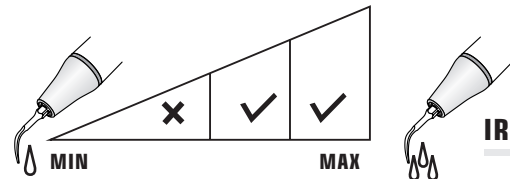
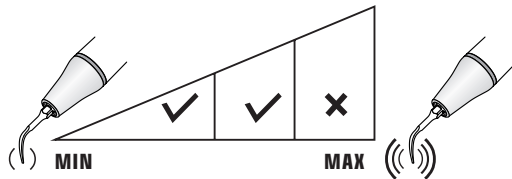

IRRIGATION

G30(GD30)

There are diamonds coated (90um) on the head of the tip, used for the preparation between pits and fissures.

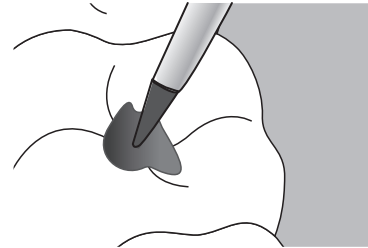
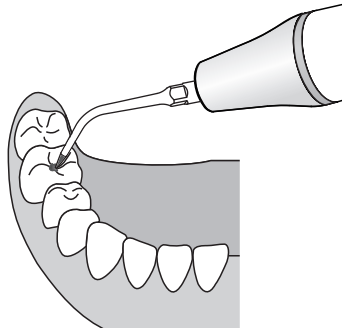
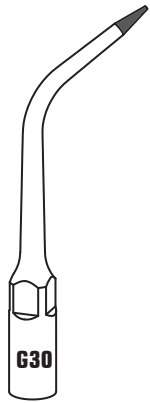

**MODE: G
POWER**

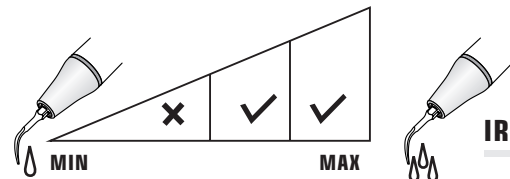
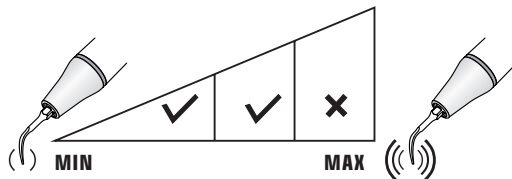

IRRIGATION

G31 (GD31)

There are diamonds coated (90um) on the head of the tip, used for the preparation of the mesial cavity.

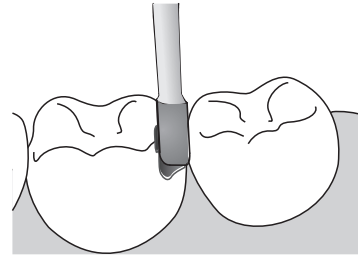
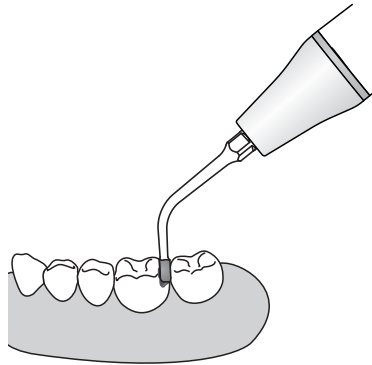

**MODE: G
POWER**

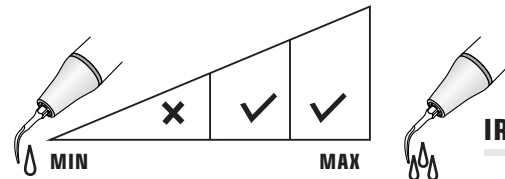
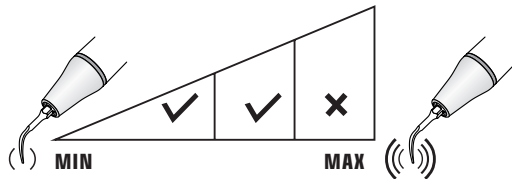

IRRIGATION

G32(GD32)

There are diamonds coated (90um) on the head of the tip, used for the preparation of the distal cavity.

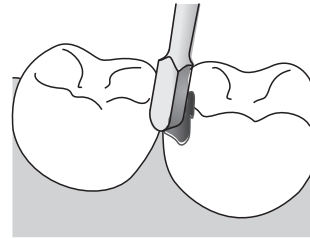
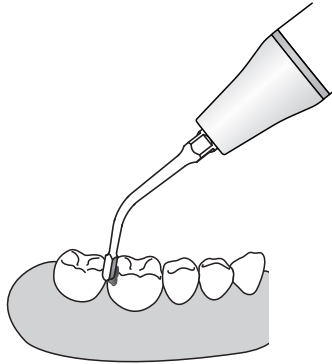
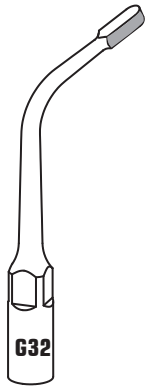

MODE: G
POWER

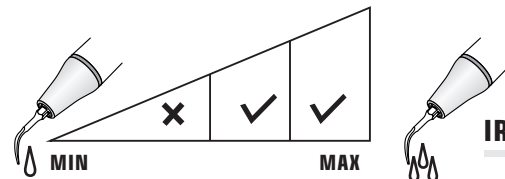
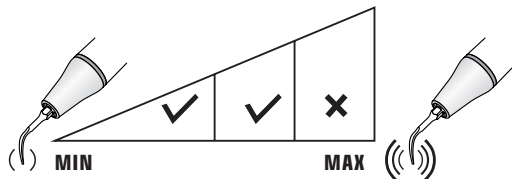

IRRIGATION

G33 (GD33)

There are diamonds coated (90um) on the head of the tip, used for the preparation of the tooth veneers.

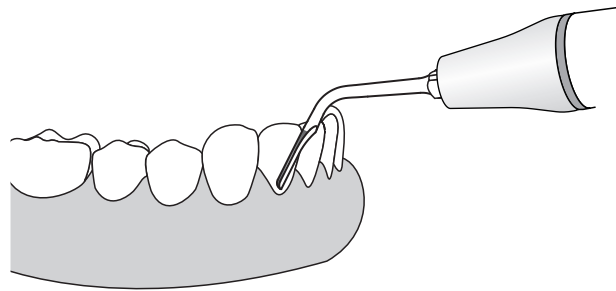
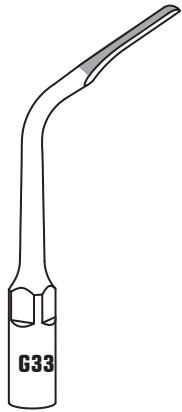

**MODE: G
POWER**

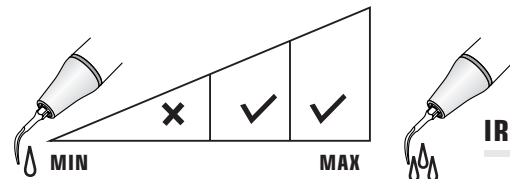
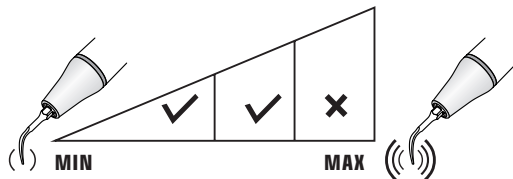

IRRIGATION

P1 (PD1/PS1)

Slim and sharp, recommended for cleaning and irrigating of subgingival deposits.

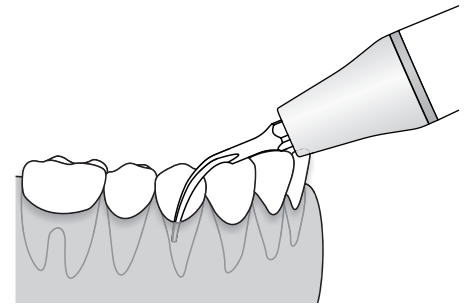
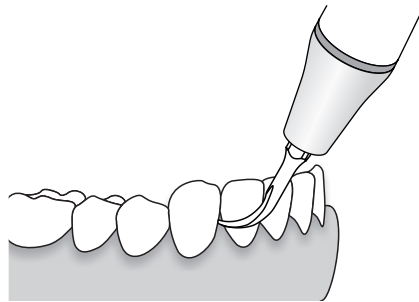
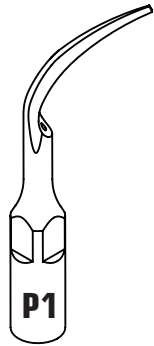

Demo Video

MODE: P
POWER

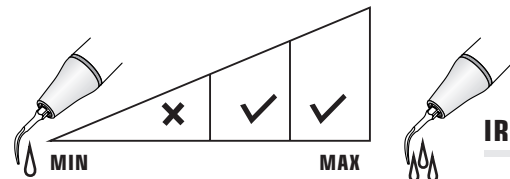
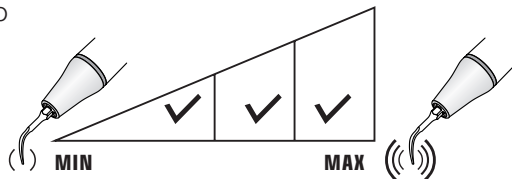

IRRIGATION

P2L(PD2L)

Left-angled, used to remove calculus from very narrow inter-root spaces and furcation.

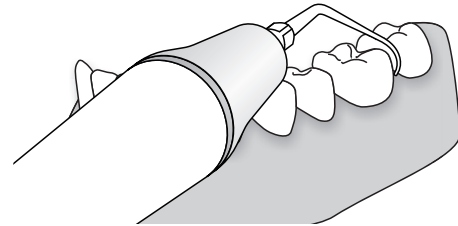
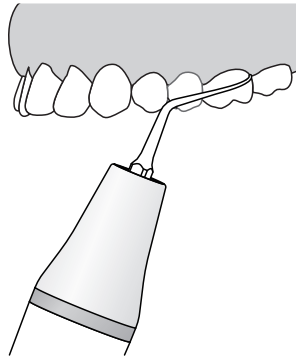
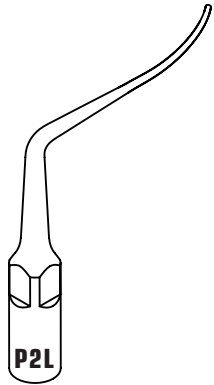

Demo Video

MODE: P

POWER

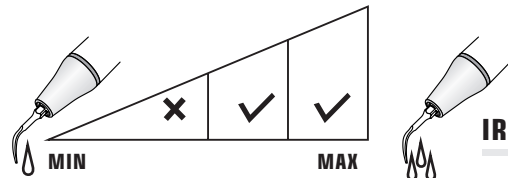
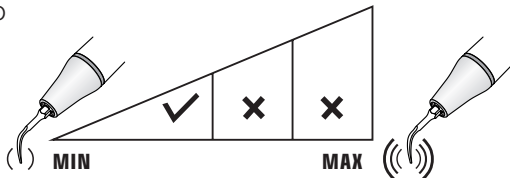

IRRIGATION

P2LD (PD2LD)

Left-angled, diamond-coated(40µm) instrument for root planing.

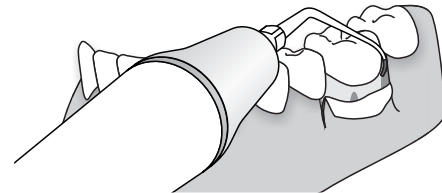
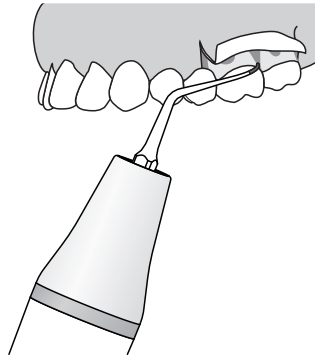
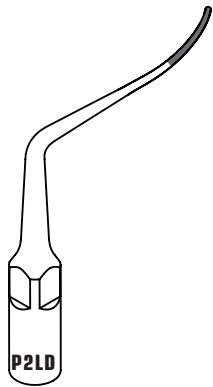

Demo Video

MODE: P
POWER

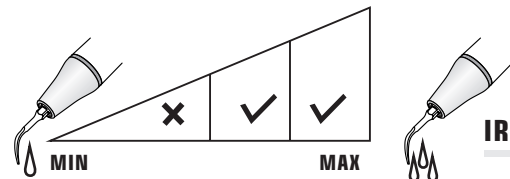
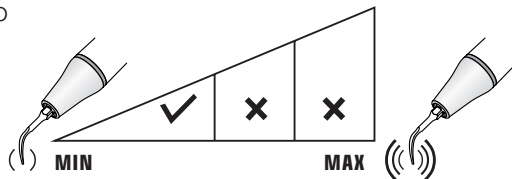

IRRIGATION

P2R (PD2R)

Right-angled, used to remove calculus from very narrow inter-root spaces and furcation.

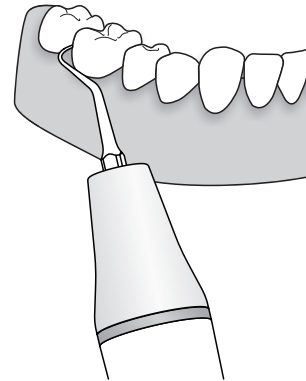
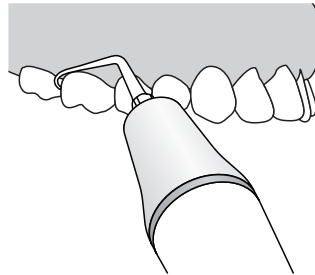
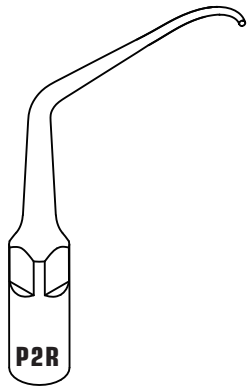

Demo Video

MODE: P

POWER

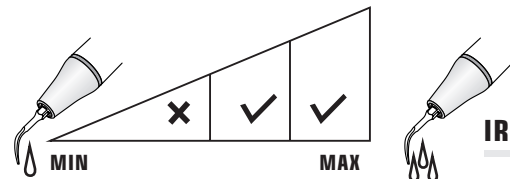
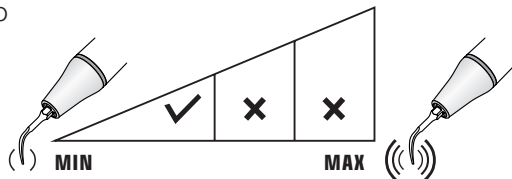

IRRIGATION

P2RD(PD2RD)

Right-angled, diamond-coated(40μm) instrument for root planing.

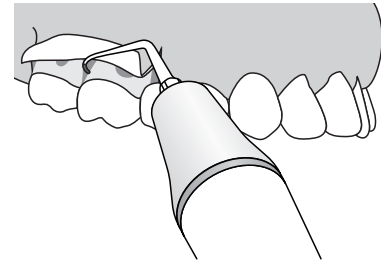
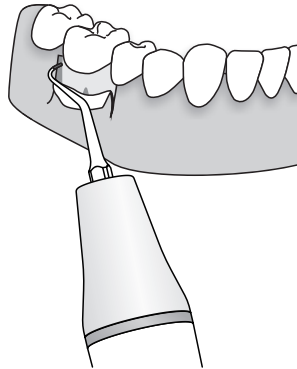
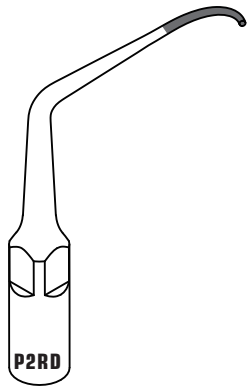

Demo Video

MODE: P
POWER

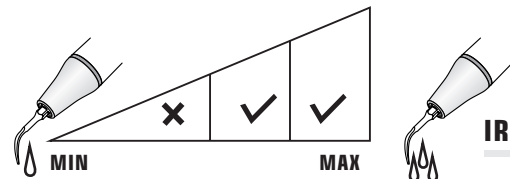
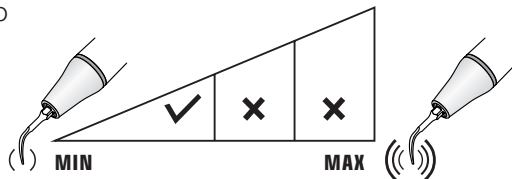

IRRIGATION

P3 (PD3/PS3)

Recommended for cleaning and irrigating of periodontal deep pockets.

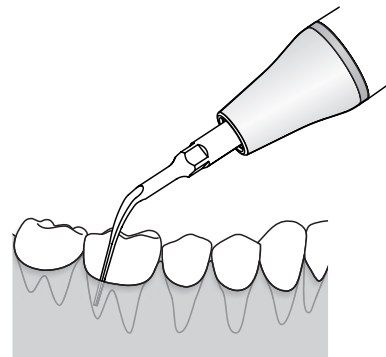
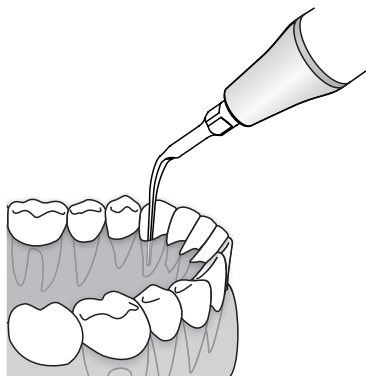
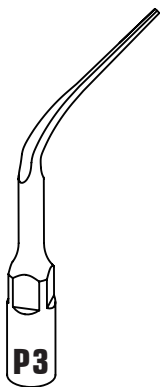

Demo Video

MODE: P

POWER

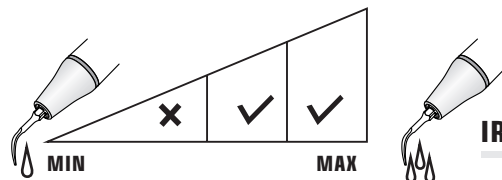
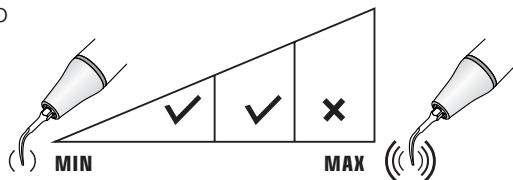

IRRIGATION

P3L (PD3L)

Left-angled, used for subgingival scaling.

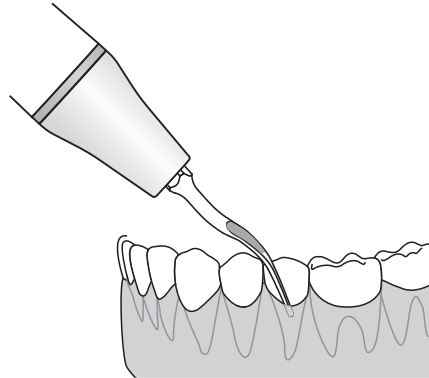

MODE: P
POWER

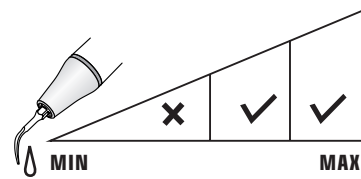
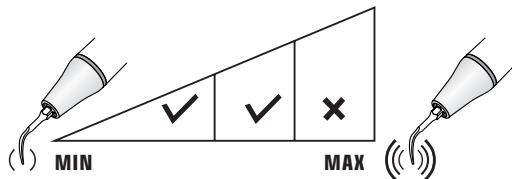

IRRIGATION

P3R (PD3R)

Right-angled, used for subgingival scaling.

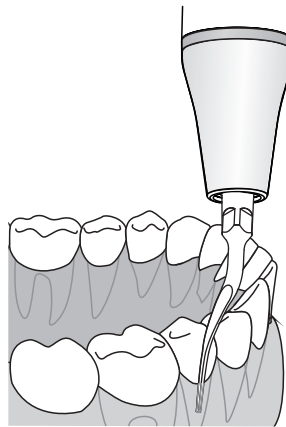

MODE: P
POWER

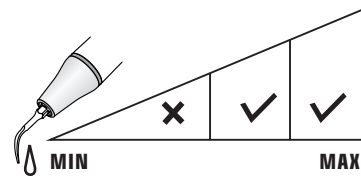
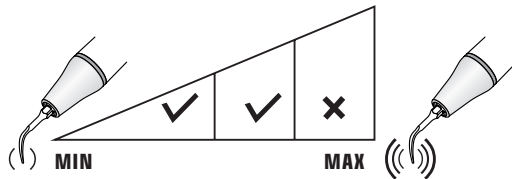

IRRIGATION

P3D(PD3D)

Diamond-coated(40 μ m) instrument for root planning after the periodontal flap surgery. It's also applied to edge planning of artificial crown and furcation expanding.

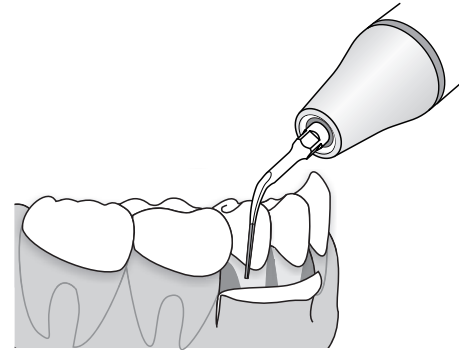
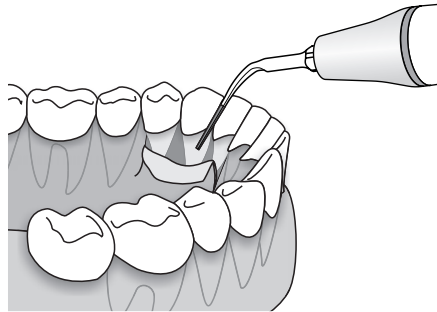
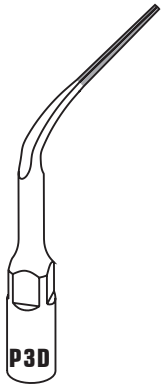

Demo Video

MODE: P
POWER

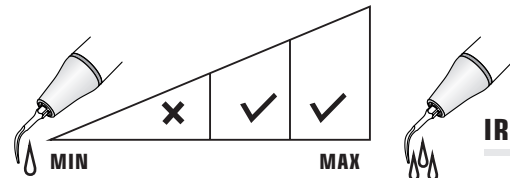
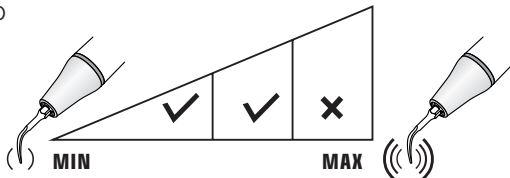

IRRIGATION

P4 (PD4/PS4)

Recommended for cleaning and irrigating of periodontal shallow pockets.

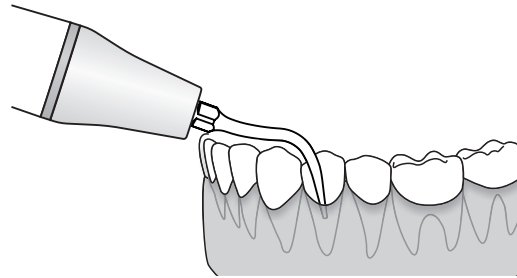
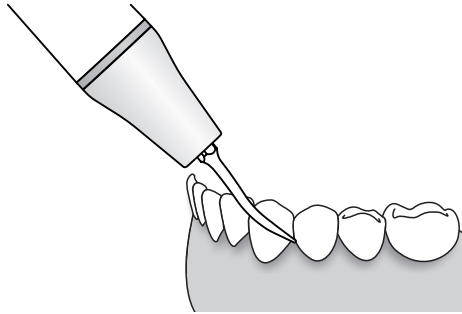
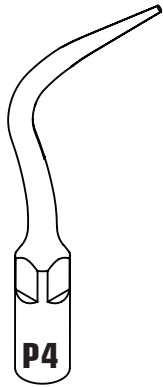

Demo Video

MODE: P
POWER

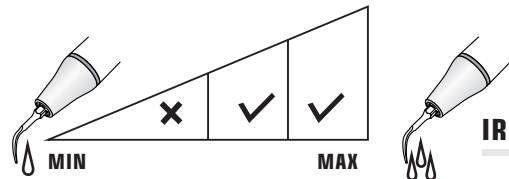
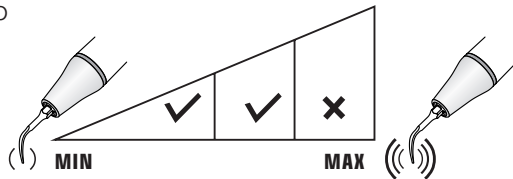

IRRIGATION

P5 (PD5)

For removal of the tartar in the adjacent of teeth and Gingival margin of the neck.

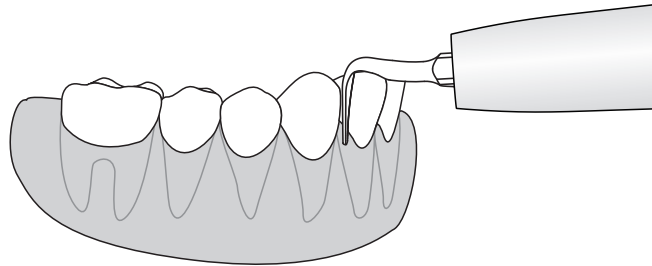

MODE: P
POWER

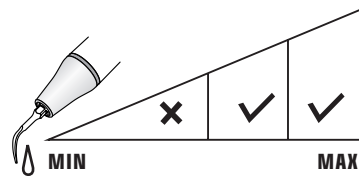
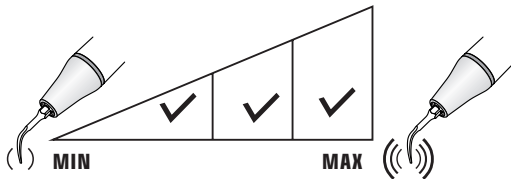

IRRIGATION



P6 (PD6)

Slim and sharp, recommended for cleaning and irrigating of periodontal deep pockets.

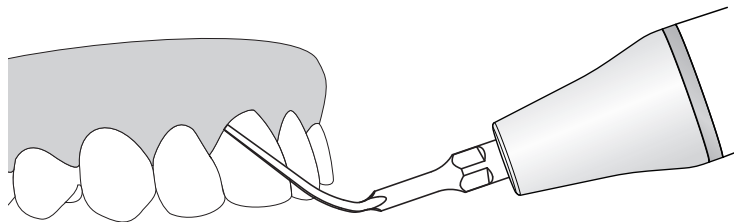
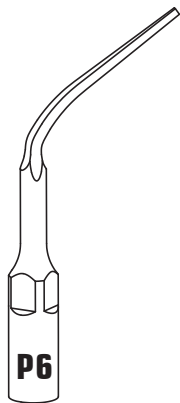

MODE: P
POWER

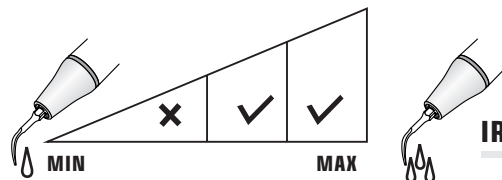
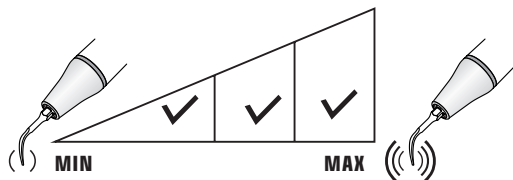

IRRIGATION

P7 (PD7)

Slim and sharp, recommended for cleaning and irrigating of subgingival deposits.

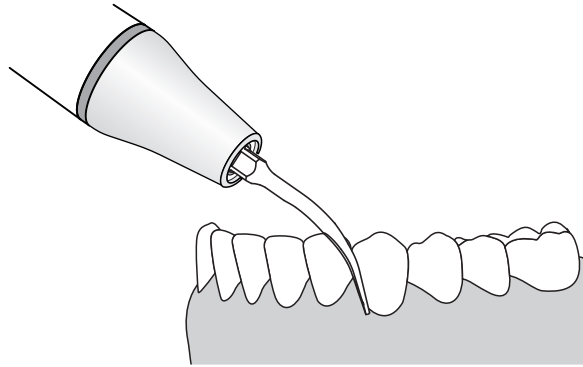
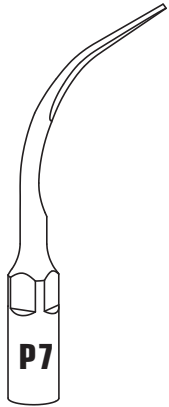

**MODE: P
POWER**

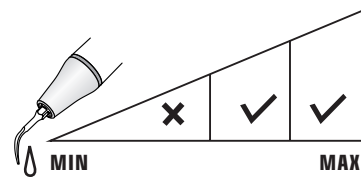
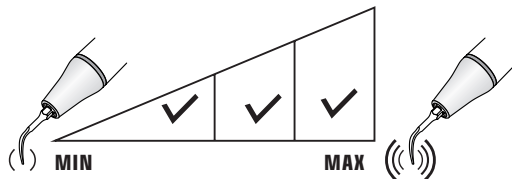

IRRIGATION

P8 (PD8)

Function: used to remove the calculus at shallow periodontal pocket and treat the adjacent tooth surface and ditch area.

Features: The tip is flat and wide, which can be used to clean the teeth surface at subgingival 1/4 and the supragingival part.

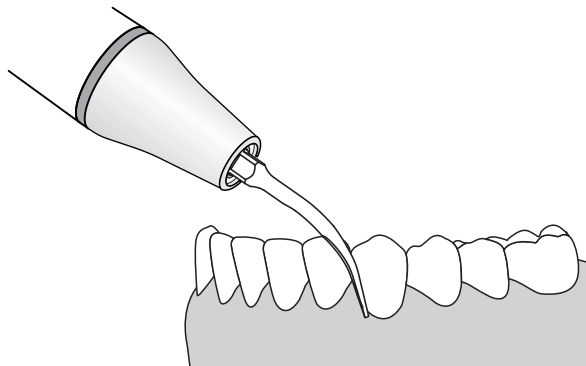
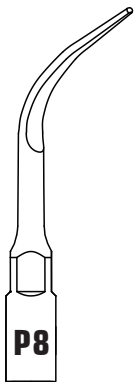

**MODE: P
POWER**

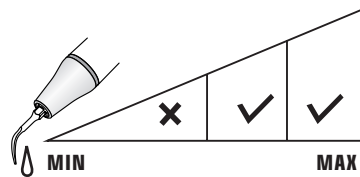
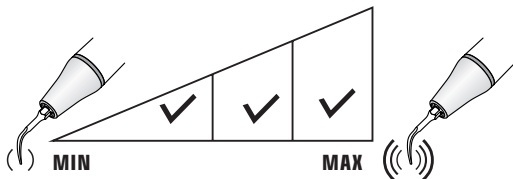

IRRIGATION

P10 (PD10)

For gentle scaling and removal of tartar in the periodontal pocket.

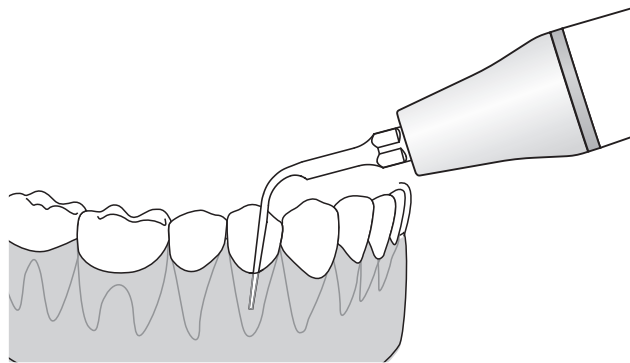
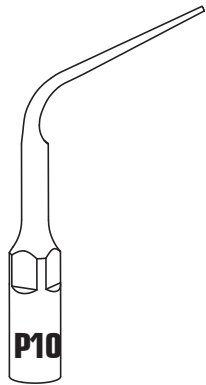

MODE: P
POWER

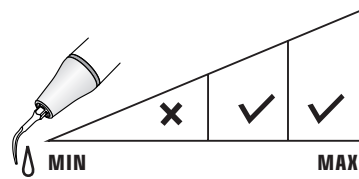
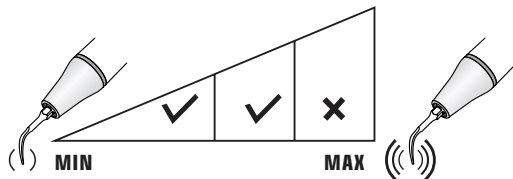

IRRIGATION

P11 (PD11)

For high efficient removal of the stubborn tartar in the subgingival.

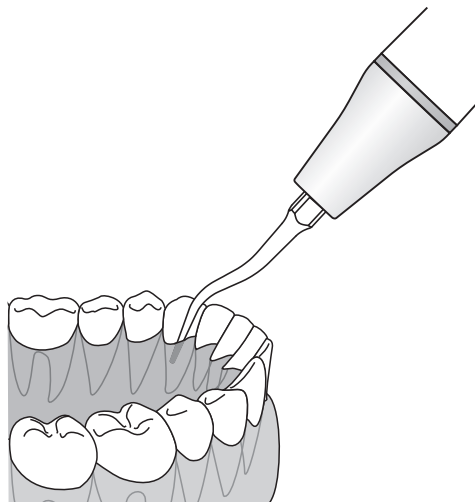

MODE: P
POWER

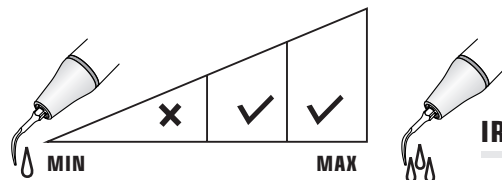
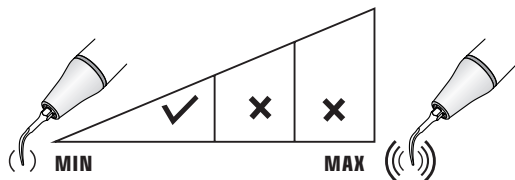

IRRIGATION

P12 (PD12)

With slim blade edge at the end of the tip, for high efficient removal of the stubborn tartar in posterior subgingival.

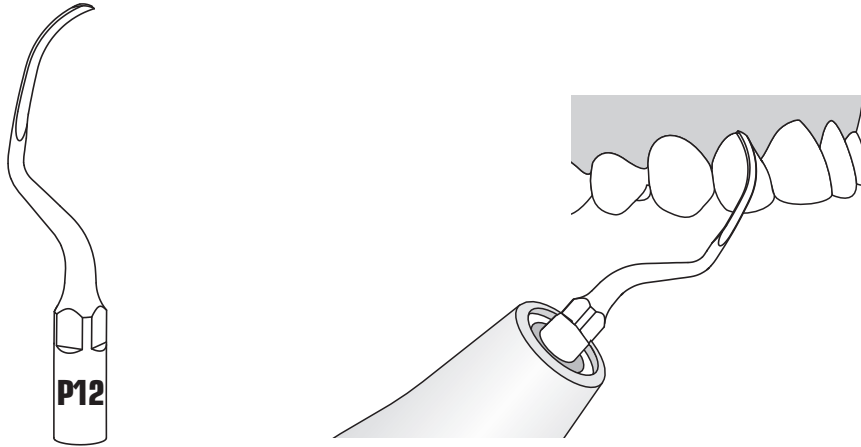

**MODE: P
POWER**

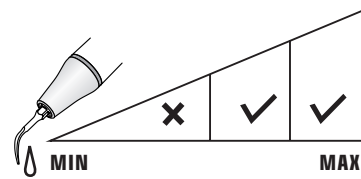
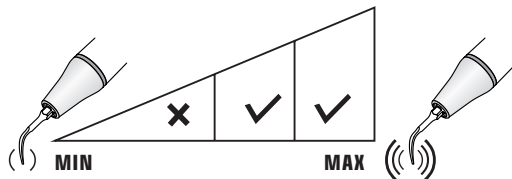

IRRIGATION

P14L(PD14L)

Left curved, with slim blade edge at the end of the tip, for high efficient removal of the stubborn tartar in posterior subgingival.

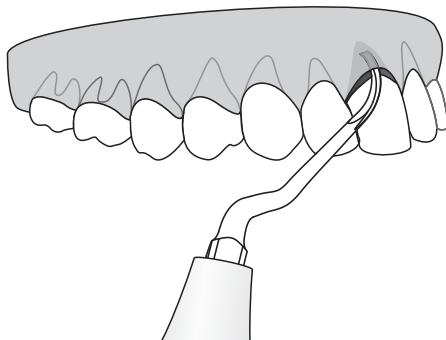
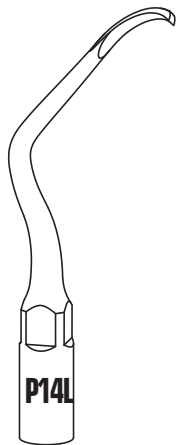

MODE: P
POWER

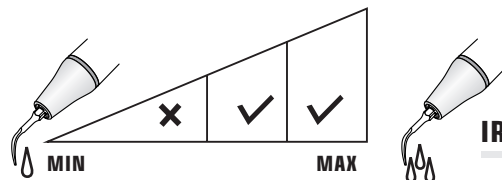
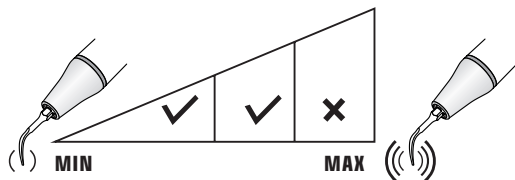

IRRIGATION

P14R (PD14R)

Right curved, with slim blade edge at the end of the tip, for high efficient removal of the stubborn tartar in posterior subgingival.

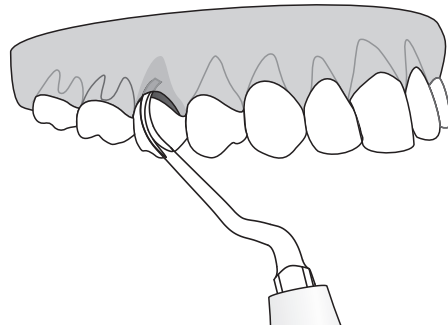
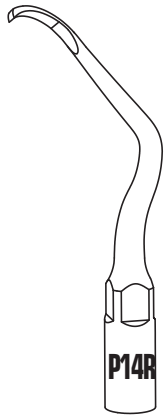

**MODE: P
POWER**

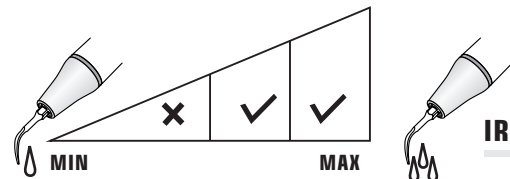
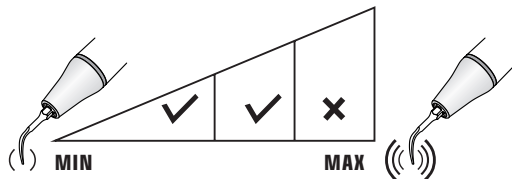

IRRIGATION

P18 (PD18)

For probing the deep periodontal pocket tartar, and subgingival rinse after scaling.

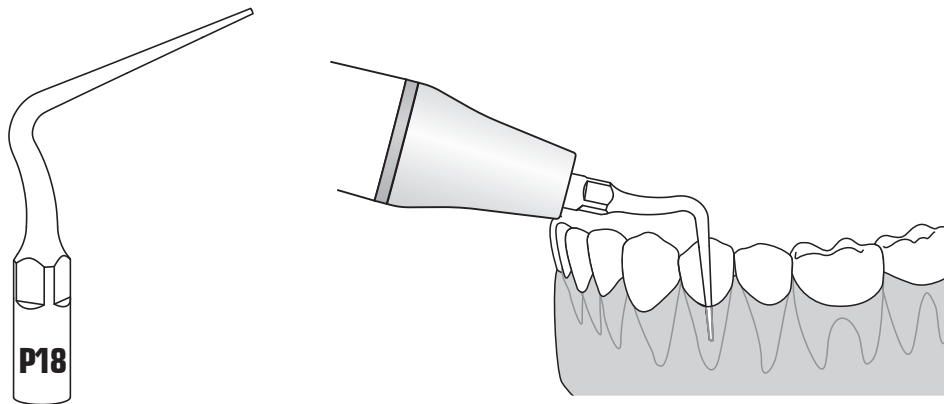

**MODE: P
POWER**

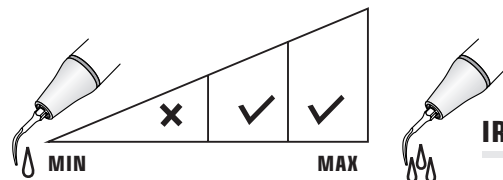
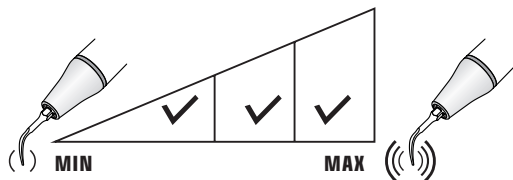

IRRIGATION

P20 (PD20)

For removal of the tartar in the adjacent of teeth, gingival margin of the neck and the tartar within 3mm in the subgingival pocket.

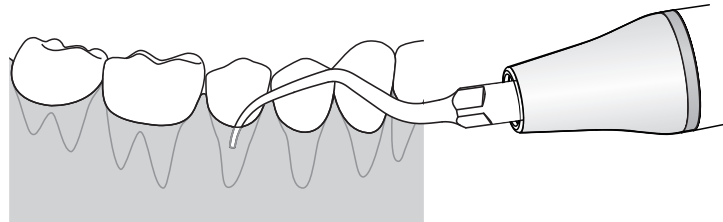

**MODE: P
POWER**

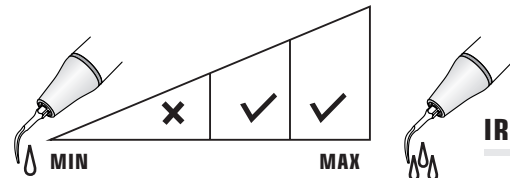
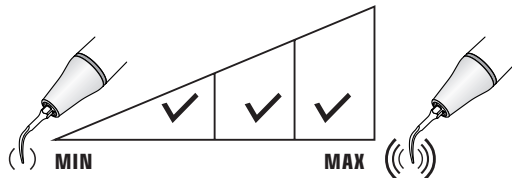

IRRIGATION

P20L (PD20L)

Left curved, for high efficient removal of the stubborn tartar in posterior subgingival.

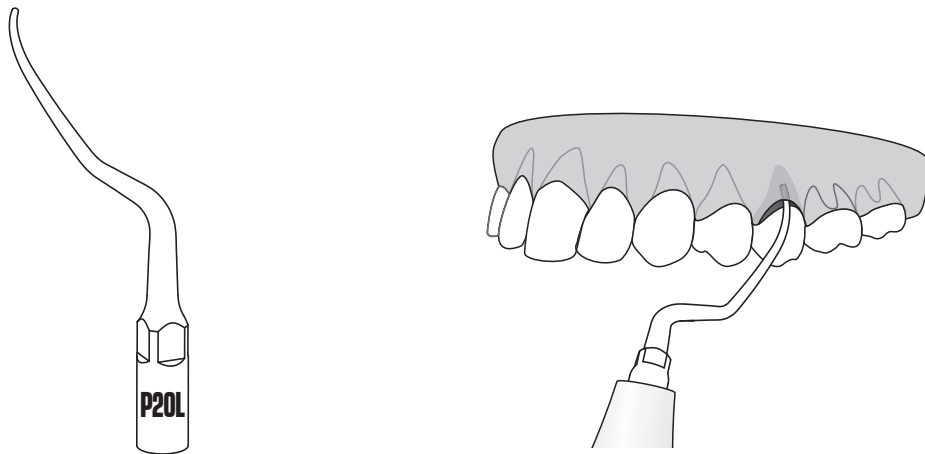

MODE: P
POWER

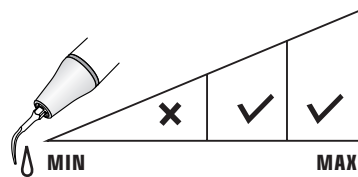
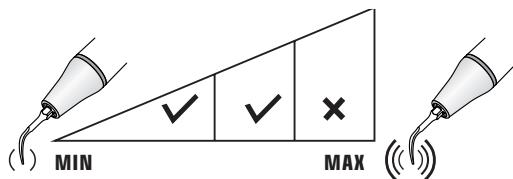

IRRIGATION

P20R (PD20R)

Right curved, for high efficient removal of the stubborn tartar in posterior subgingival.

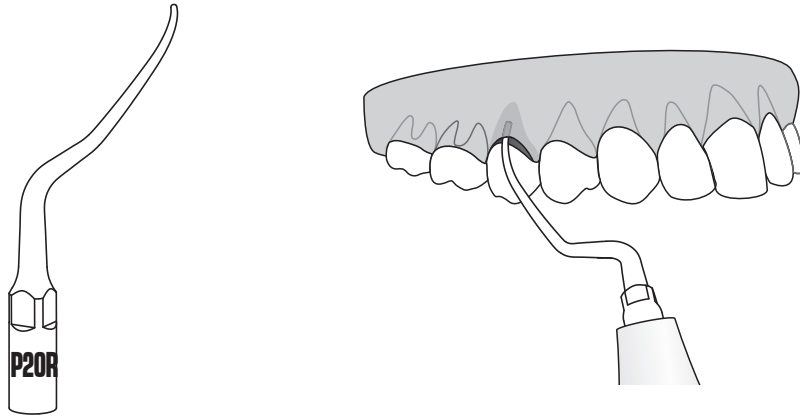

MODE: P
POWER

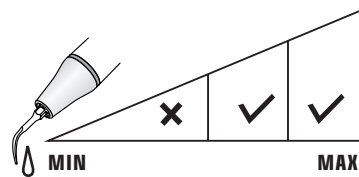
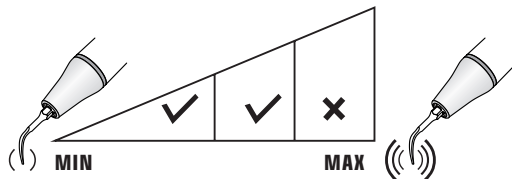

IRRIGATION

P21L(PD21L)

Left curved, for the scaling of root bifurcation and root surface of adjacent of posterior teeth sector.

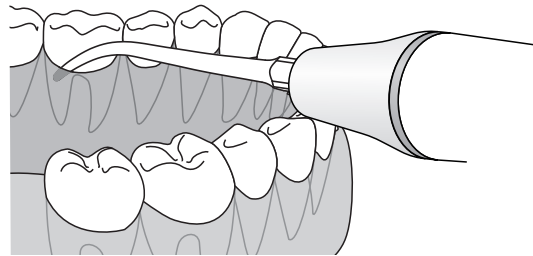

MODE: P
POWER

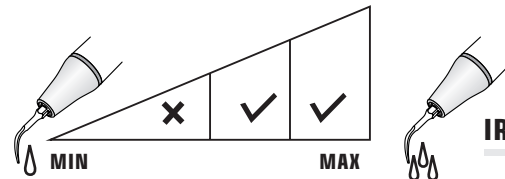
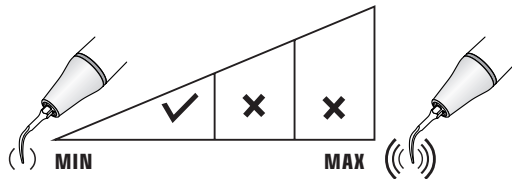

IRRIGATION

P21R (PD21R)

Right curved, for the scaling of root bifurcation and root surface of adjacent of posterior teeth sector.

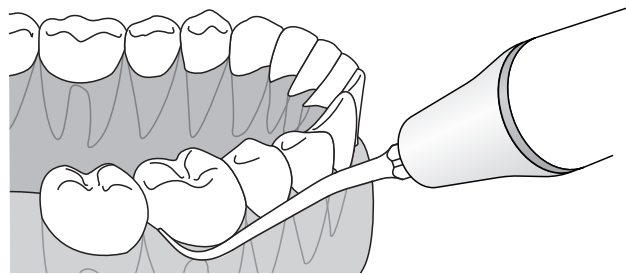

MODE: P
POWER

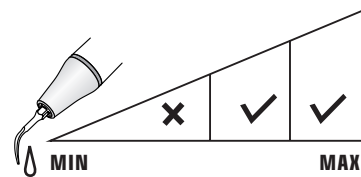
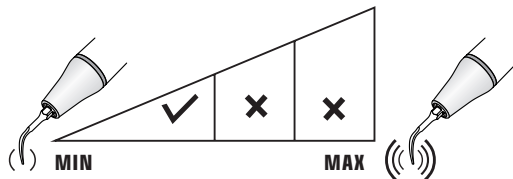

IRRIGATION



P22L(PD22L)

Left curved, the 12mm straight part can assure the complete removal of subgingival tartar and stains.

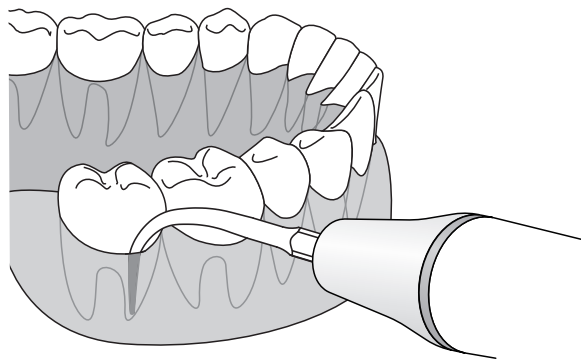
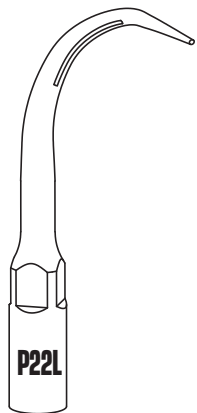

MODE: P
POWER

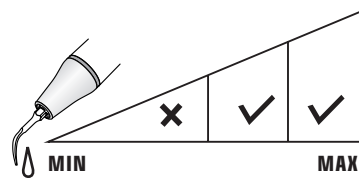
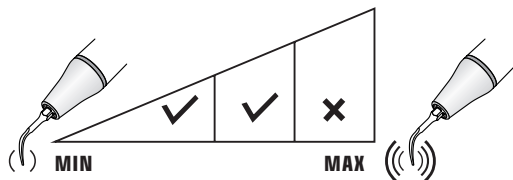

IRRIGATION

P22R (PD22R)

Right curved, the 12mm straight part can assure the complete removal of subgingival tartar and stains.

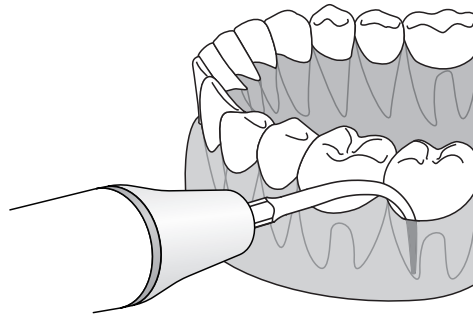
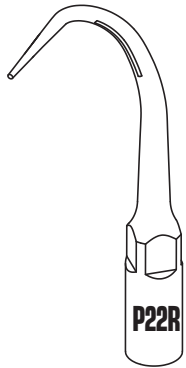

**MODE: P
POWER**

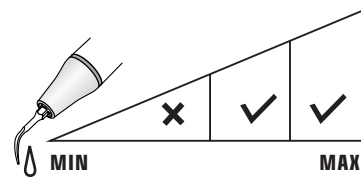
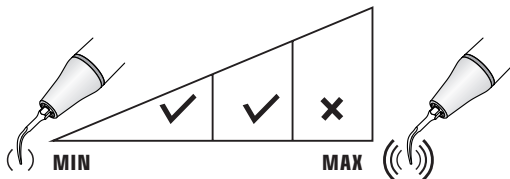

IRRIGATION

P33

Function: Used to remove calculus deep in the periodontal pocket and rinse the periodontal pocket.

Features: The tip is slender and can be used for fine scaling of subgingival root surface.

Use: Used in P mode of PT5. Recommended power level: level 1~8

Note:

(1) The tip is mainly used for treatment in deep periodontal pockets. During use, the power should be set as small as possible and cannot exceed the recommended power level.

(2) The tip has an irrigating function on the periodontal pocket. During operation, the water volume should be set as large as possible.

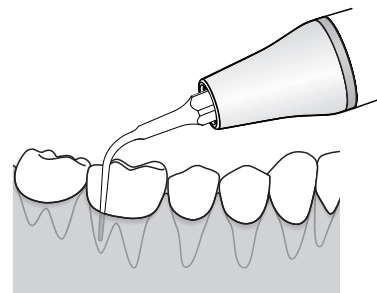
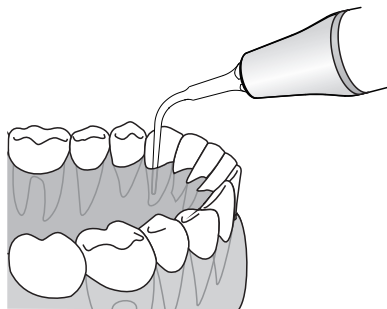
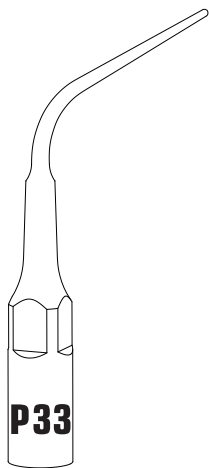

MODE: P

POWER

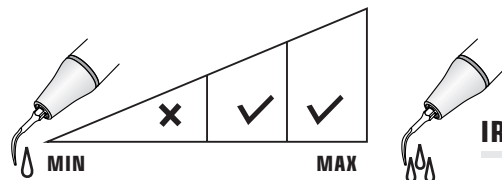
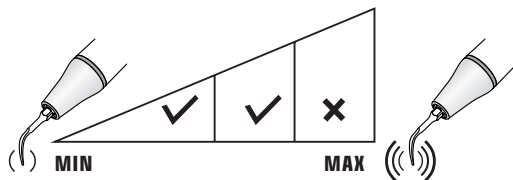

IRRIGATION

PD40

Function: It can be used as an adapter to hold the implant maintenance tips PD41 and PD42 to clean and maintain the implant.

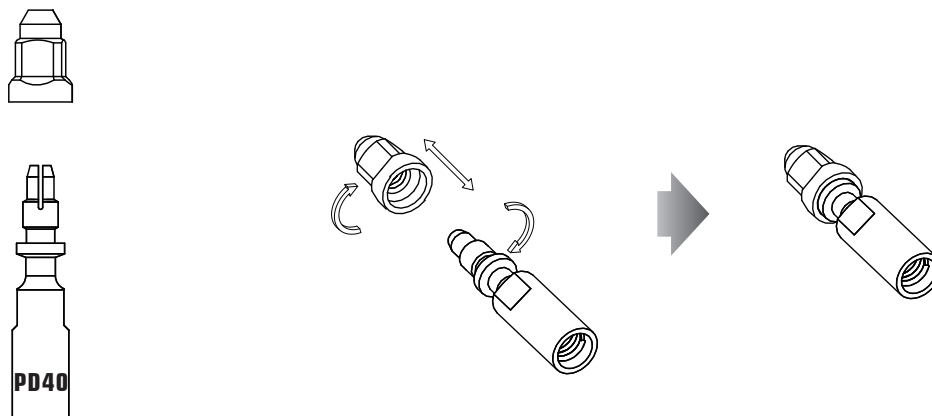

MODE: P
POWER

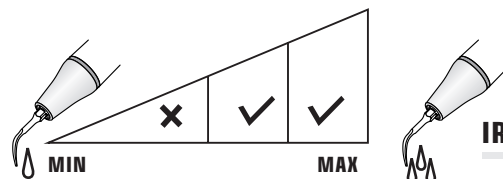
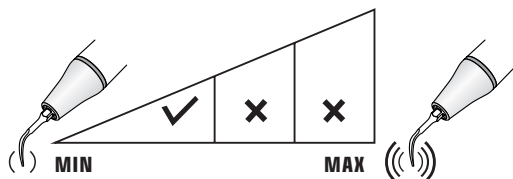

IRRIGATION

PD41

Function: For implant maintenance. It can be installed to PD40 adapter to realize the cleaning and maintenance of implant.

Size: Plastic head is of 15mm length

Features: The tip is of a slender hook shape, making it easier for subgingival cleaning and maintenance.

Use:

a. Used in P mode of D600. Recommended power level: level 1~3. b. Used in P mode of S6. Recommended power level: level 1~6

Note:

(1) The plastic part is made of PEEK material which can be disinfected under high temperature and high pressure, the higher the power, the easier it is to wear;

(2) Avoid the tip stuck in the gap of the tooth during operation to avoid breaking the tip.

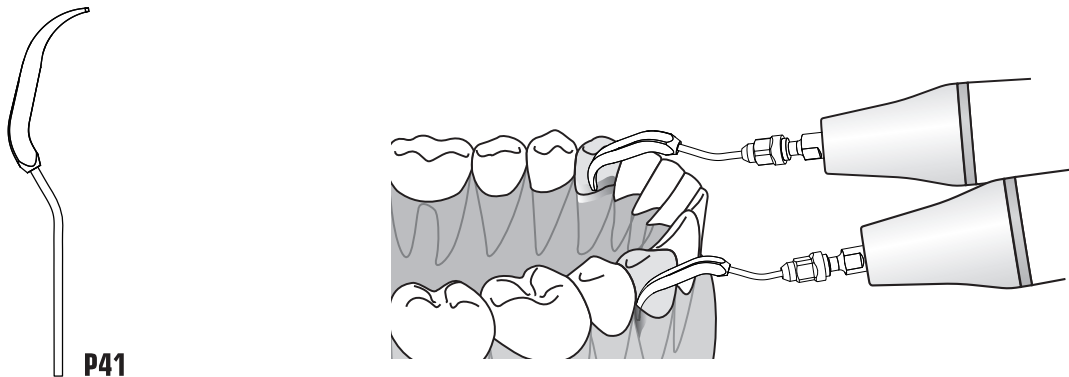

MODE: P
POWER

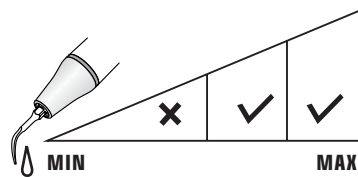
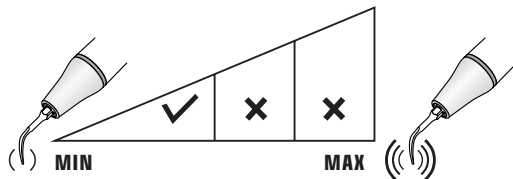

IRRIGATION

PD42

Function: For implant maintenance. It can be installed to PD40 adapter to realize the cleaning and maintenance of implant.

Size: Plastic head is of 19mm length

Features: The tip is of a slender hook shape, making it easier for subgingival cleaning and maintenance.

Use:

a. Used in P mode of d600. Recommended power level: level 1~5. b. Used in P mode of S6. Recommended power level: level 1~9.

Note:

(1) The plastic part is made of PEEK material which can be disinfected under high temperature and high pressure, the higher the power, the easier it is to wear;

(2) Avoid the tip stuck in the gap of the tooth during operation to avoid breaking the tip.

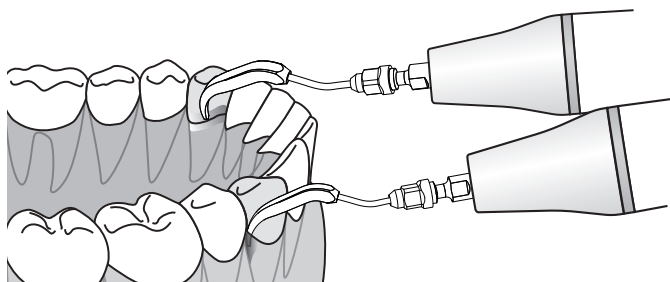
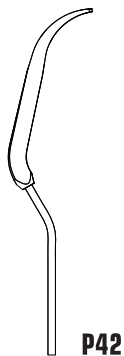

MODE: P
POWER

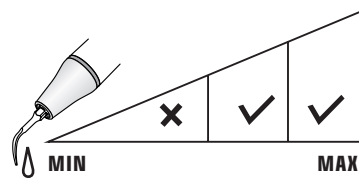
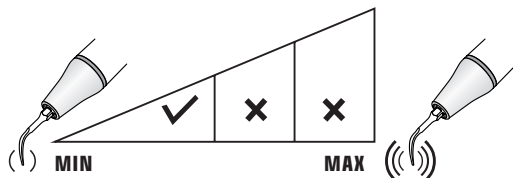

IRRIGATION

PD43L

Function: implant maintenance tip installed on PD40 adapter to realize the cleaning and maintenance of dental implants.

Plastic head length: 21mm

Feature: The tip is of a slender hook shape, making it easier to clean and maintain in subgingival part. The tip end is twice bent, so it does not touch the adjacent teeth and buccal surface, enabling wider application areas.

Use:

Used in P mode of D600; recommended power level: level 1~8

Used in P mode of S6; recommended power level: level 1~12

Used in P mode of ordinary scalers; recommended power level: low (level 1~3)

Note:

(1) The plastic part is made of autoclavable PEEK material. The higher the power, the easier it is to wear.

(2) Avoid the tip stuck in the gap of the tooth during operation to prevent breaking the tip.

(3) Before use, please make sure that the water output of handpiece is normal, and then install the tip to avoid damage to the tip.

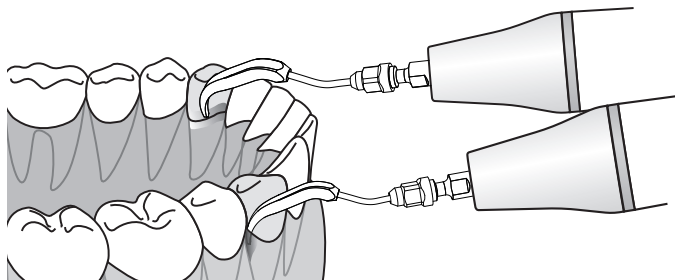
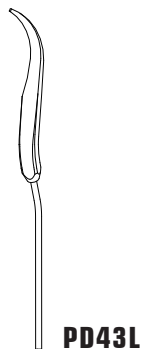

MODE: P
POWER

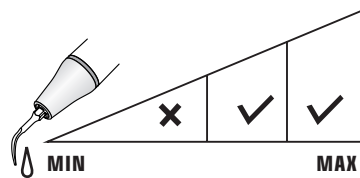
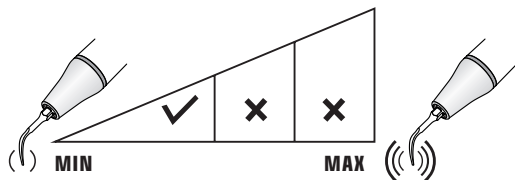

IRRIGATION

PD43R

Function: implant maintenance tip installed on PD40 adapter to realize the cleaning and maintenance of dental implants.

Plastic head length: 21mm

Feature: The tip is of a slender hook shape, making it easier to clean and maintain in subgingival part. The tip end is twice bent, so it does not touch the adjacent teeth and buccal surface, enabling wider application areas.

Use:

Used in P mode of D600; recommended power level: level 1~8

Used in P mode of S6; recommended power level: level 1~12

Used in P mode of ordinary scalers; recommended power level: low (level 1~3)

Note:

(1) The plastic part is made of autoclavable PEEK material. The higher the power, the easier it is to wear.

(2) Avoid the tip stuck in the gap of the tooth during operation to prevent breaking the tip.

(3) Before use, please make sure that the water output of handpiece is normal, and then install the tip to avoid damage to the tip.

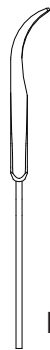

PD43R

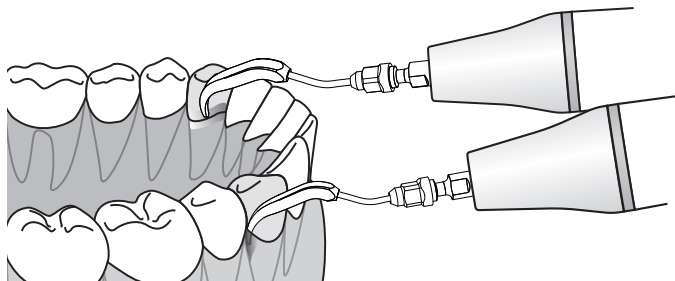

MODE: P
POWER

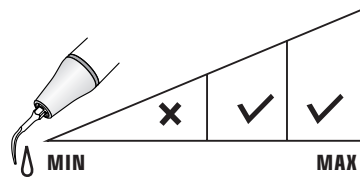
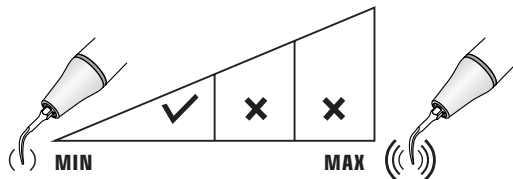

IRRIGATION



E1(ED1/ES1)

120° holder, used to hold the file diameter $\Phi 0.7\text{mm}$ or $\Phi 0.8\text{mm}$.

Recommended for the cleaning and irrigating of the root canal, usually used for the anterior teeth.

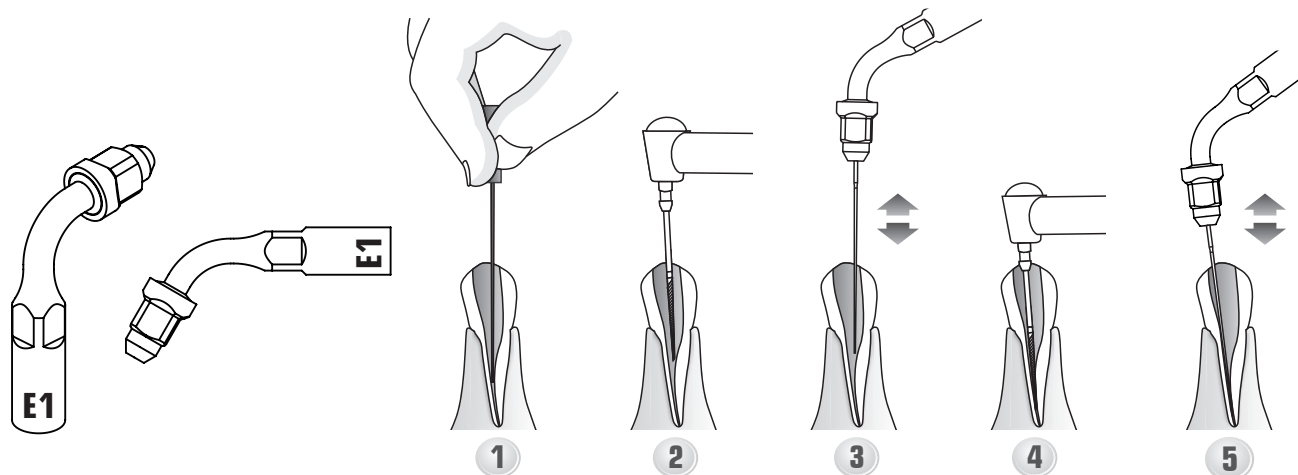

Demo Video

Use only the provided flat wrench to tighten the file holders on the handpiece, as well as for gently tightening the files or instruments in the holder. Do not over tighten.

Do not tighten the holder nut when no file or instrument is installed as this may damage it.

Do not mix-install the holder with $\Phi 0.7\text{mm}$ and $\Phi 0.8\text{mm}$ file, the $\Phi 0.8\text{mm}$ file will not be able to be installed after a $\Phi 0.7\text{mm}$ file installed on the holder. Each Endo file is recommended to be used not more than 10 times.

MODE: E

POWER

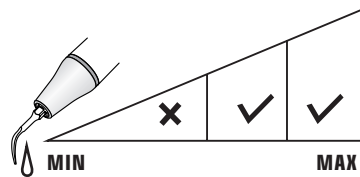
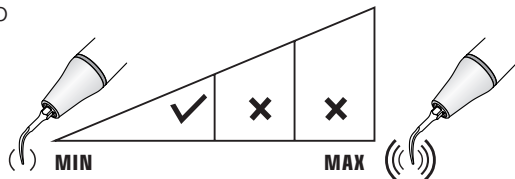

IRRIGATION

E2 (ED2/ES2)

95° holder, used to hold the file diameter $\Phi 0.7\text{mm}$ or $\Phi 0.8\text{mm}$.

Recommended for cleaning and irrigation of the root canal, usually used for the molar teeth.

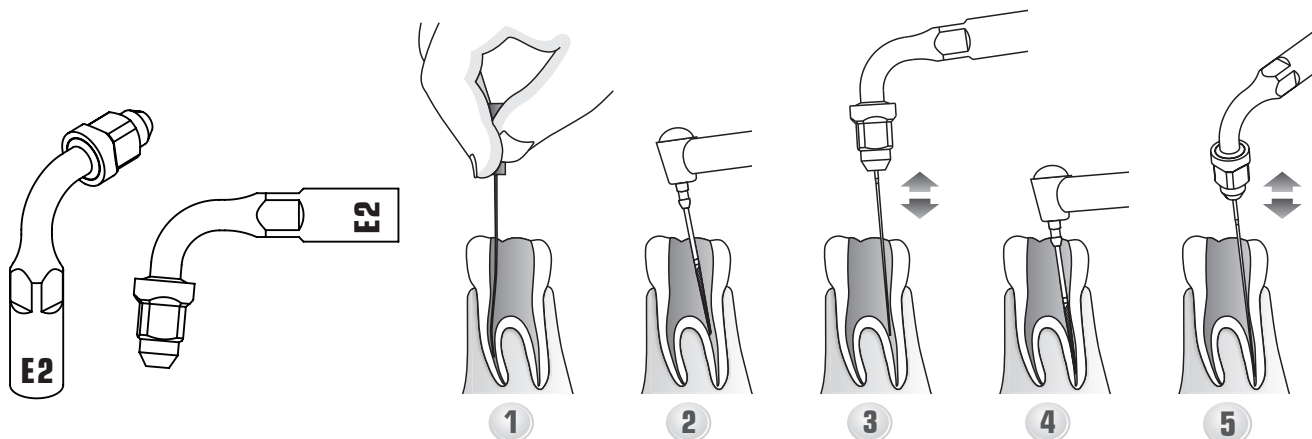

Demo Video

Use only the provided flat wrench to tighten the file holders on the handpiece, as well as for gently tightening the files or instruments in the holder. Do not over tighten.

Do not tighten the holder nut when no file or instrument is installed as this may damage it.

Do not mix-install the holder with $\Phi 0.7\text{mm}$ and $\Phi 0.8\text{mm}$ file, the $\Phi 0.8\text{mm}$ file will not be able to be installed after a $\Phi 0.7\text{mm}$ file installed on the holder. Each Endo file is recommended to be used not more than 10 times.

MODE: E
POWER

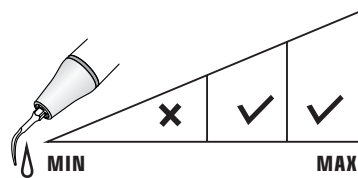
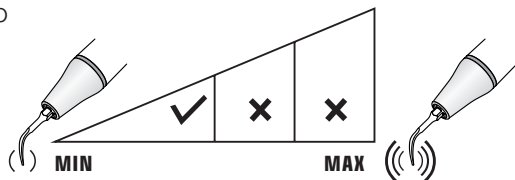

IRRIGATION

E3 (ED3/ES3)

Recommended for melting gutta-percha.

Immerse the instrument in eugenol before inserting it in the canal.

Slightly press the instrument against the cone of gutta-percha and activate the scaler to condense until the canal is filled.

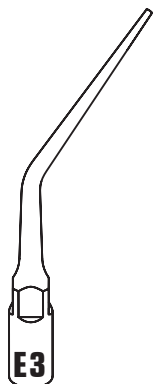

Demo Video

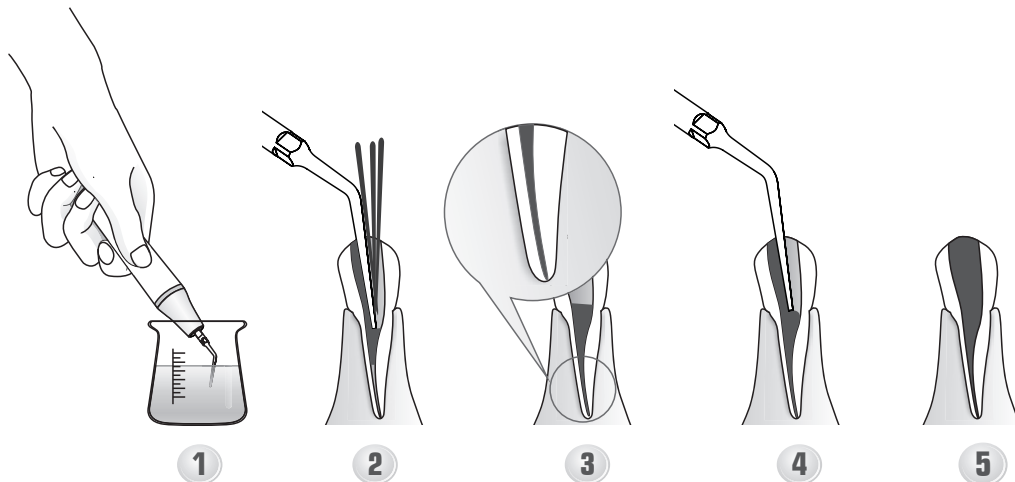

MODE: E

POWER

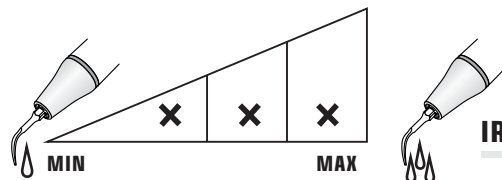
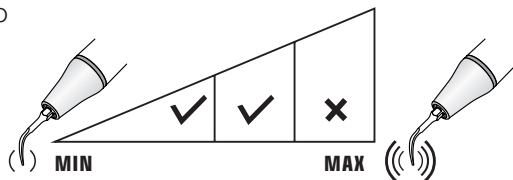

E3D(ES3D)

Diamond-coated(40 μ m) instrument for enlarging the root canal and access to files broken in the root canal.

Don't touch the broken file when enlarging the root canal in case putting it deeper in the canal.

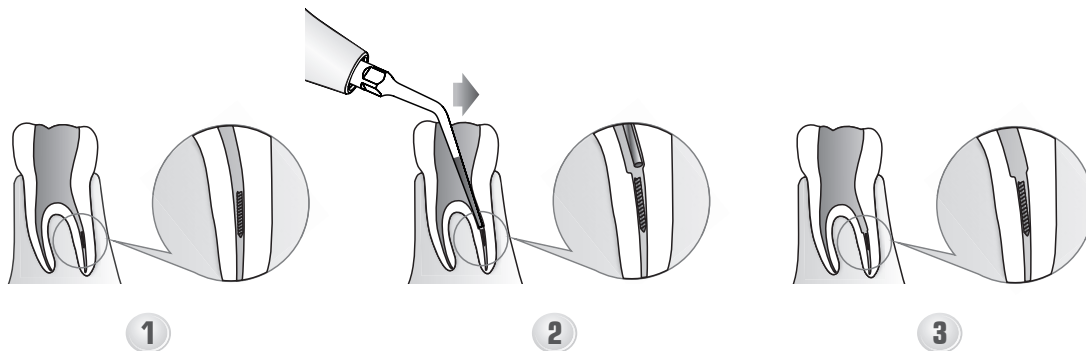
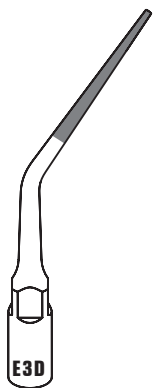

Demo Video

MODE: E
POWER

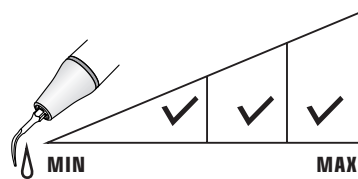
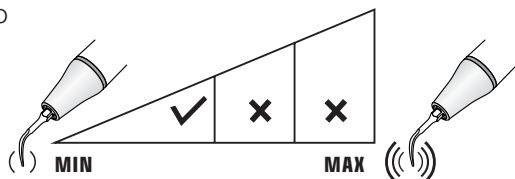

IRRIGATION

ED3D

Diamond-coated(40µm) instrument for enlarging the root canal and access to files broken in the root canal.

Don't touch the broken file when enlarging the root canal in case putting it deeper in the canal.

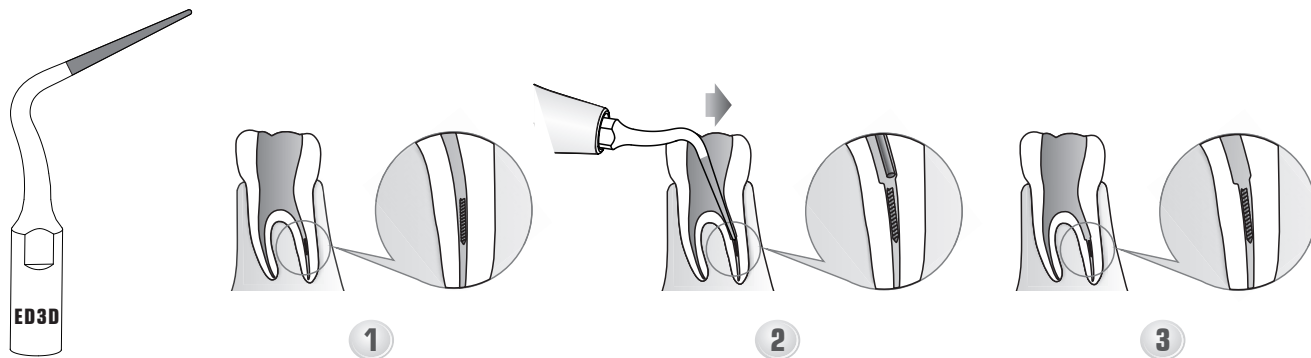

MODE: E
POWER

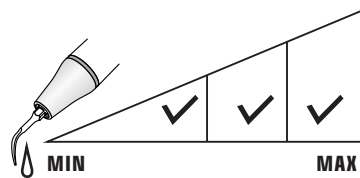
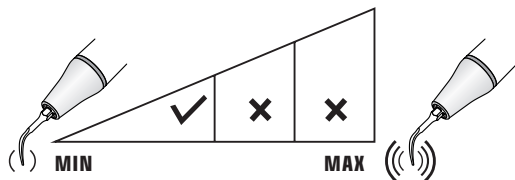

IRRIGATION

E4(ED4/ES4)

Used to remove the root filling obstructions during the root canal retreatment. The length of tip slender part is (22mm).

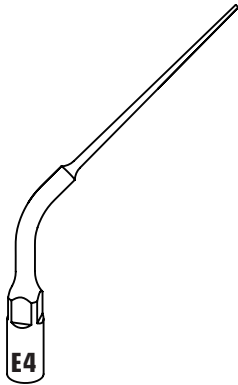

Demo Video

MODE: E
POWER

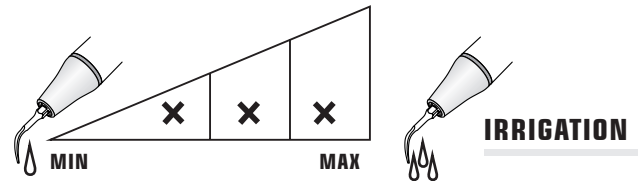
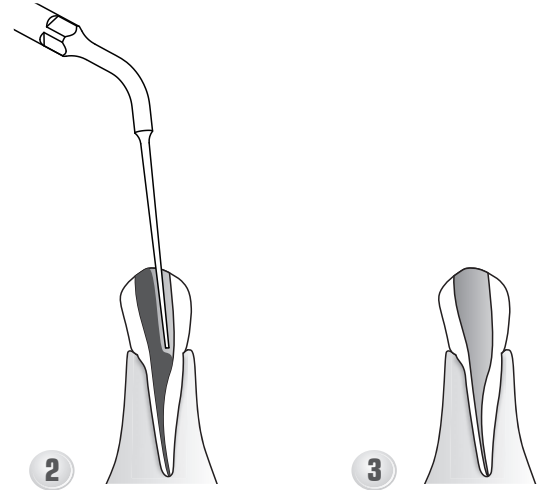
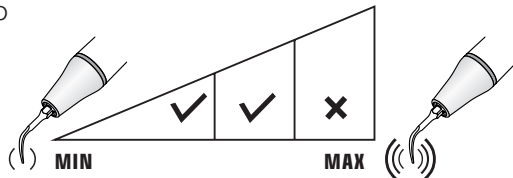

E4D(ED4D/ES4D)

Diamond-coated(40 μ m) instrument for removing the calcification and bad filling material in the root canal during the root canal retreatment. The length of the diamond-coated on tip is (15mm).

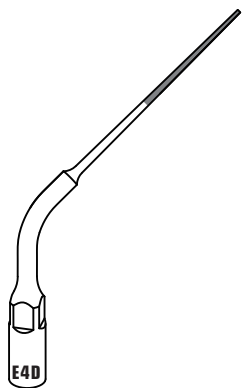

1

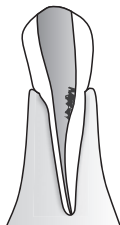

2

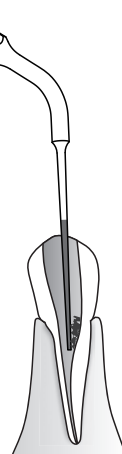

3

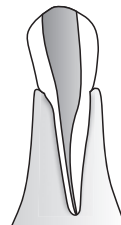

Demo Video

MODE: E
POWER

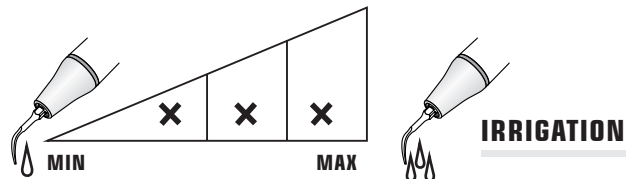
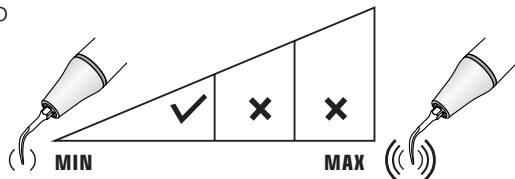

E5 (ED5/ES5)

Used to remove the root filling obstructions during the root canal retreatment. The length of tip slender part is (16mm).

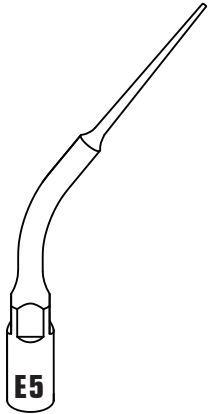

Demo Video

MODE: E
POWER

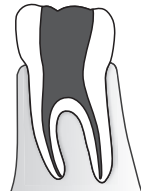
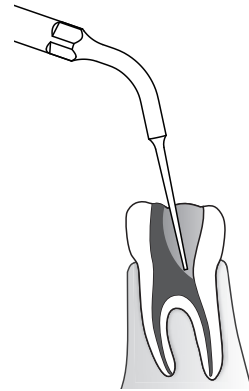
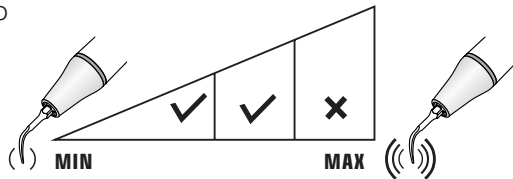

1

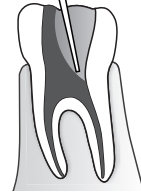

2

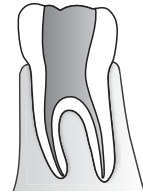

3

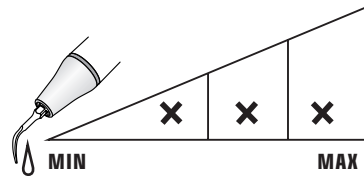

IRRIGATION

E5D(ED5D/ES5D)

Diamond-coated(40 μ m) instrument for removing the calcification and bad filling material in the root canal during the root canal retreatment. The length of the diamond-coated on tip is (10mm).

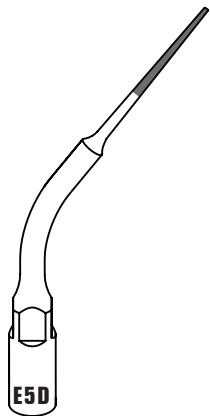

Demo Video

MODE: E
POWER

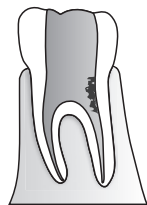
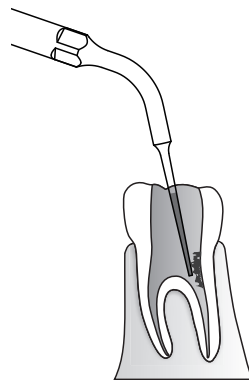
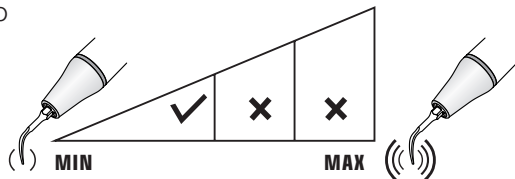

1

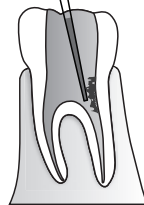

2

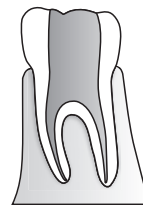

3

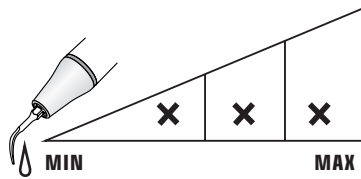

IRRIGATION

P4D (PD4D/PS4D)

Diamond-coated (40 μ m) instrument for root canal orientation. It can also be used to remove the calcifications located at the 1/3 part of root canal.

Don't press too much during the treatment to avoid hurting the root canal.

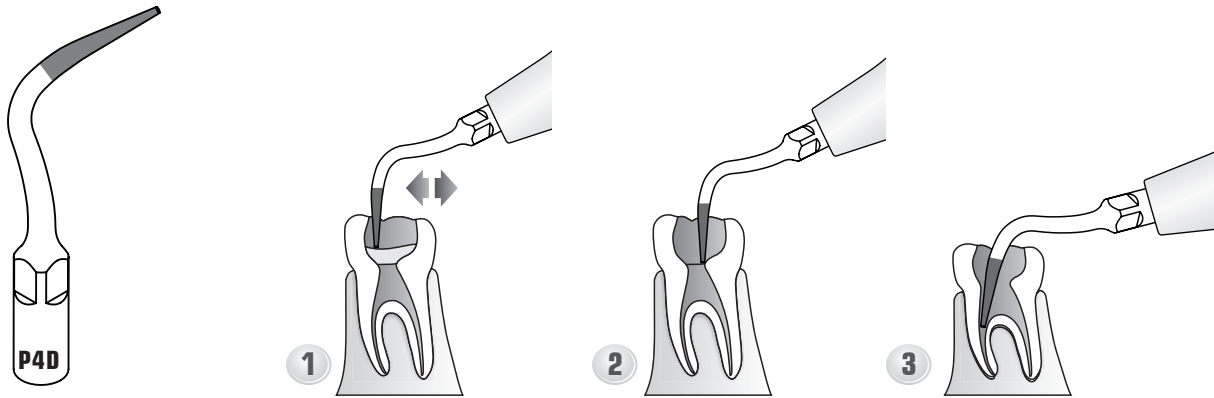

MODE: E
POWER

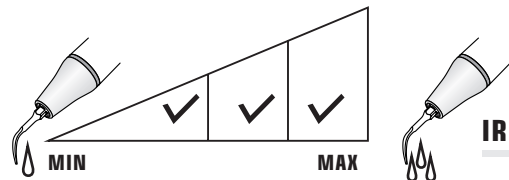
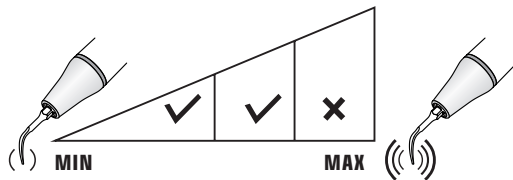

IRRIGATION

E6 (ED6)

Thin and flexible, used for removing foreign body in deep canal.

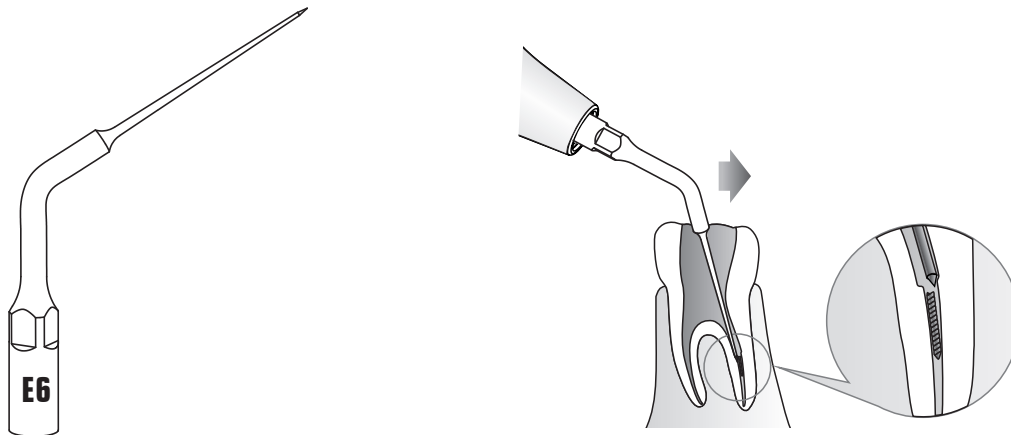

MODE: E
POWER

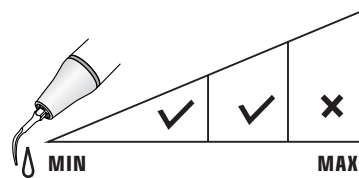
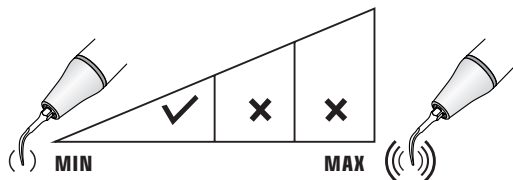

IRRIGATION

E7 (ED7)

Thin and flexible, used for removing foreign body in 1/3 canal.

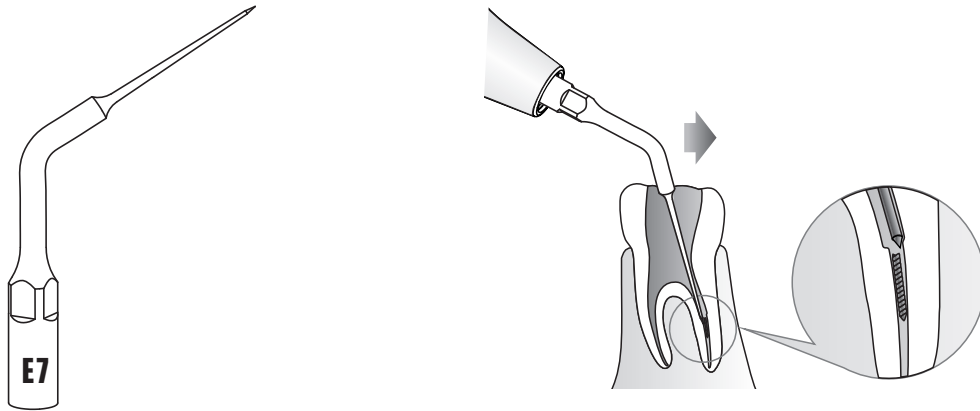

**MODE: E
POWER**

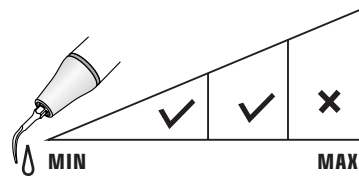
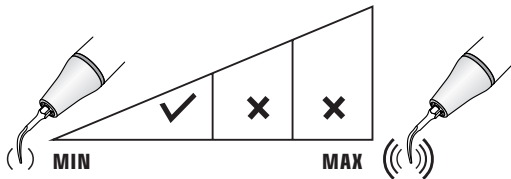

IRRIGATION

E8 (ED8/ES8/EK8)

Recommended for holding different types of dental bur to realize a variety of treatment on teeth. Usually used for the anterior teeth.

Special burs used for dental implant is applicable.

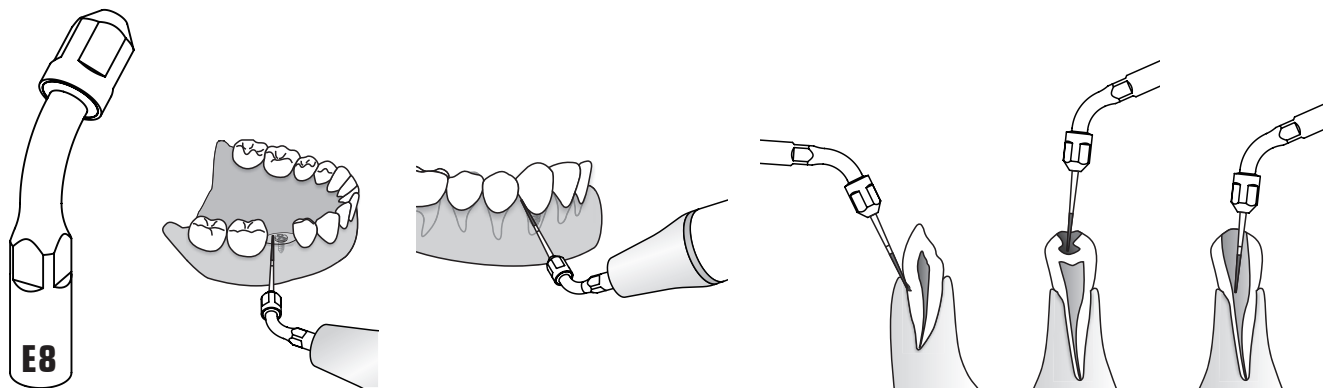

Demo Video

MODE: E

POWER

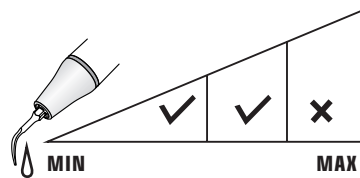
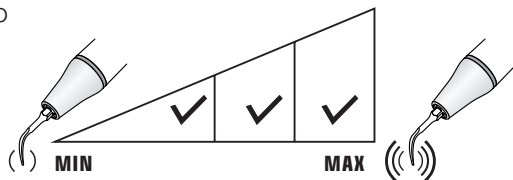

IRRIGATION

E9 (ED9)

Recommended for holding different types of dental bur to realize a variety of treatment on teeth. Usually used for the molar teeth.

Special burs used for dental implant is applicable.

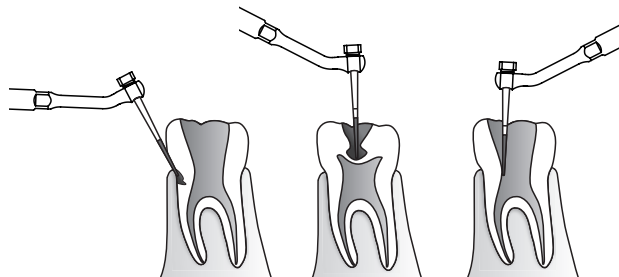
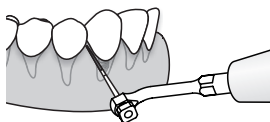
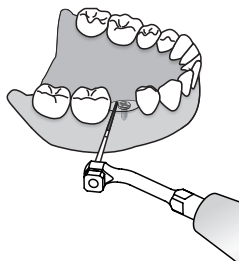
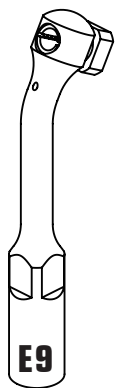

Demo Video

MODE: E
POWER

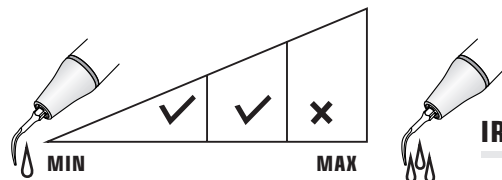
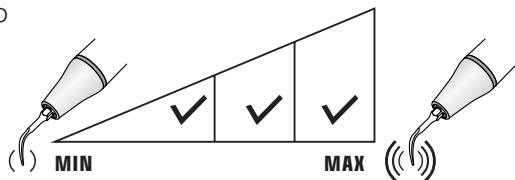

IRRIGATION

E10(ED10/ES10)

Used to polish the root canal in the retrograde preparation of root canals. The length of tip slender part is (4.5mm).

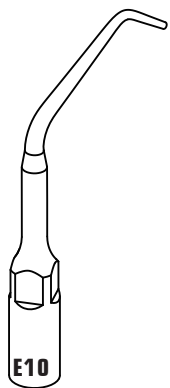

Demo Video

MODE: E
POWER

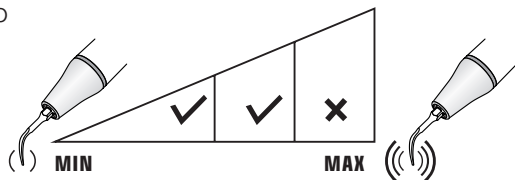

1

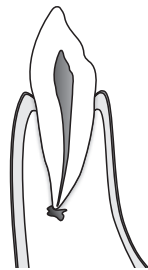

2

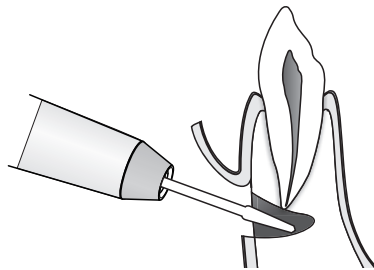

3

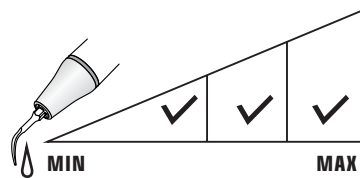
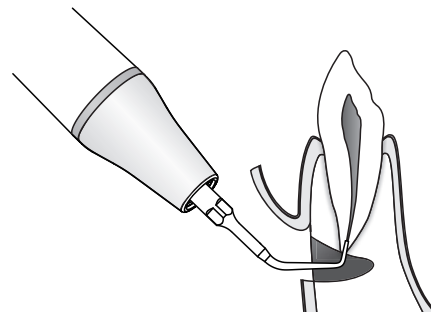

IRRIGATION

E10D(ED10D/ES10D)

Diamond-coated(40 μ m) instrument for high efficiency root planning in the retrograde preparation of root canals. The length of the diamond-coated on tip is (3.3mm).

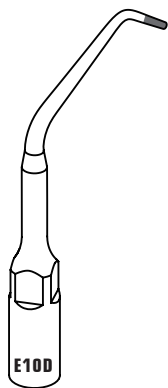

Demo Video

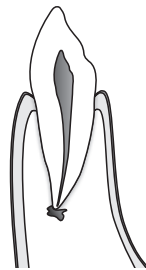

1

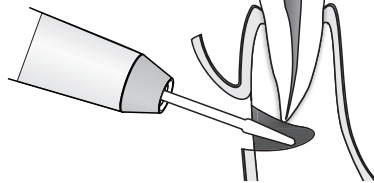

2

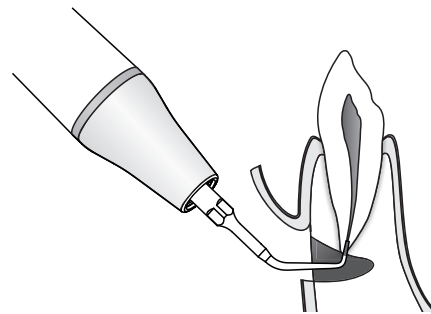

3

MODE: E
POWER

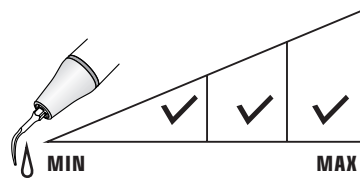
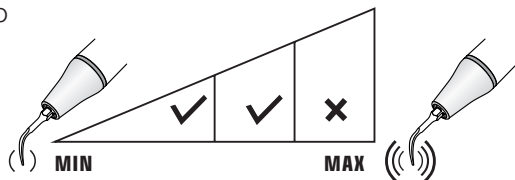

IRRIGATION

E11(ED11/ES11)

Used to polish the root canal in the retrograde preparation of root canals. The length of tip slender part is (3.5mm).

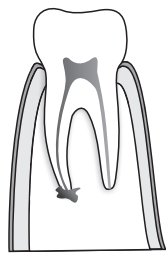
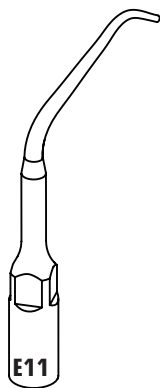

1

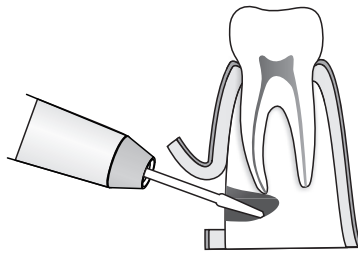

2

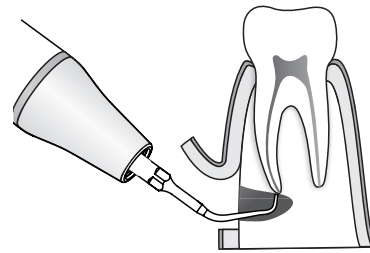

3



Demo Video

MODE: E
POWER

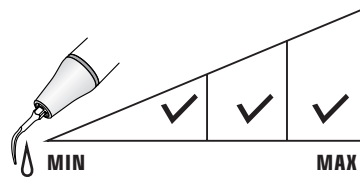
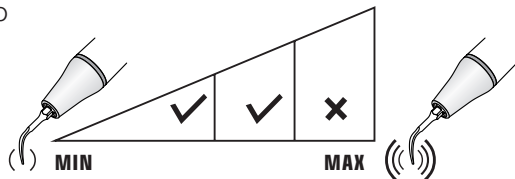

IRRIGATION

E11D(ED11D/ES11D)

Diamond-coated(40µm) instrument for high efficiency root planning in the retrograde preparation of root canals. The length of the diamond-coated on tip is (2.2mm).

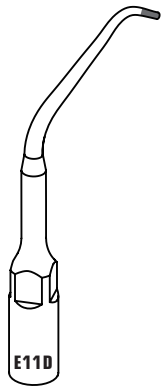

Demo Video

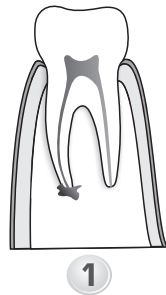

1

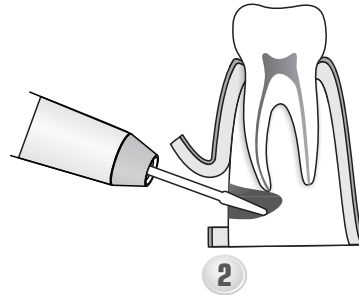

2

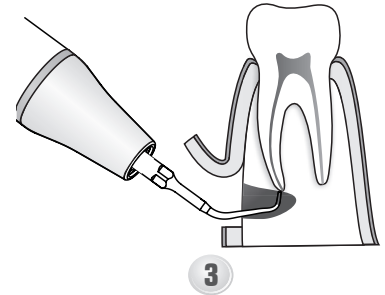

3

MODE: E
POWER

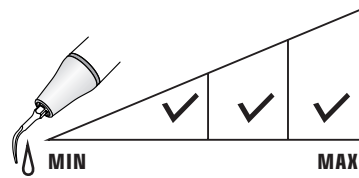
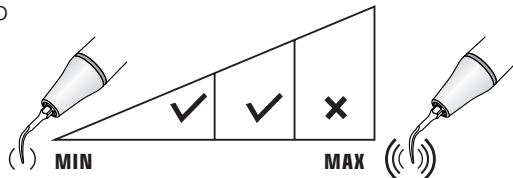

IRRIGATION

E12D(ED12D)

Diamond-coated(90um), used for removing the calcification and bad filling material of pulp cavity,exposing the root canal orifice.

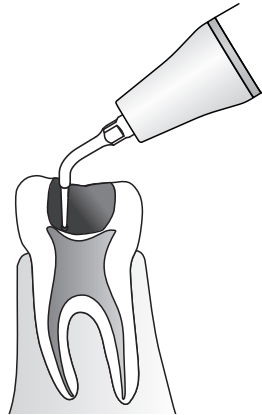
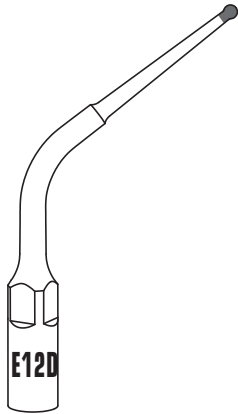

MODE: E
POWER

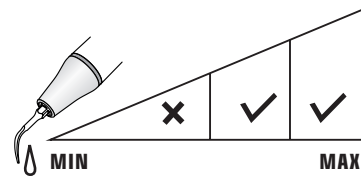
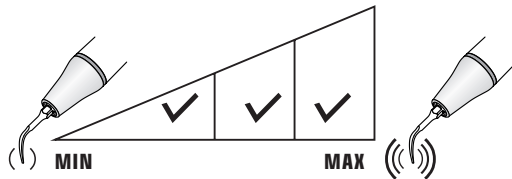

IRRIGATION

E14(ED14/ES14)

Instrument for the removal of broken files inside the root canal. The length of tip slender part is (22mm).

If possible place the patient's head in a position where the root canal is horizontal with a downward inclination. Rotate the tip of the instrument counterclockwise around the broken part until it is picked out from the root canal.

To avoid push the broken file deeper into the root canal, do not use pressure to the instrument in the axial direction.

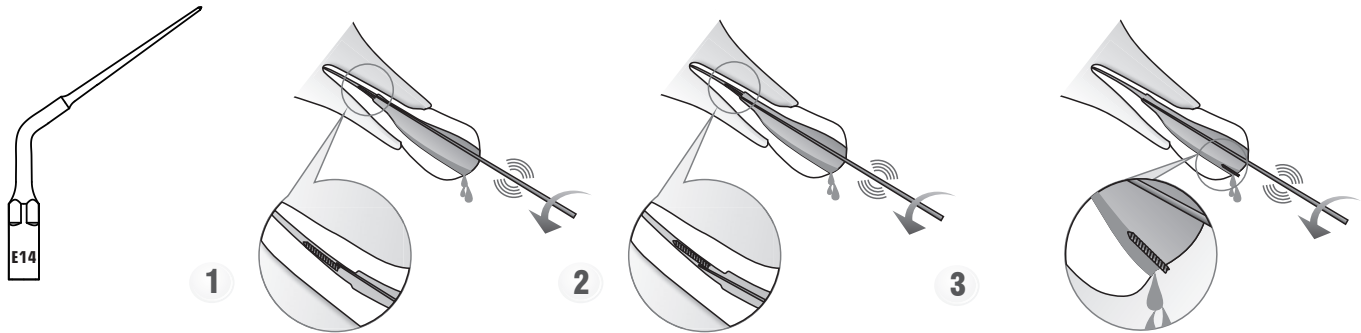

Demo Video

MODE: E
POWER

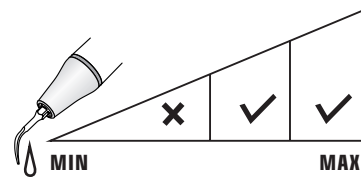
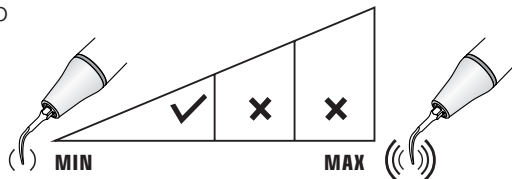

IRRIGATION

E14D(ED14D)

Diamond-coated(40um) instrument for removing the calcification and bad filling material in the root canal during the root canal retreatment. The length of the diamond-coated on tip is (15mm). With irrigation.

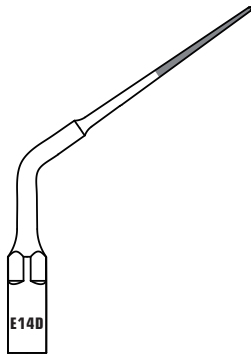

1

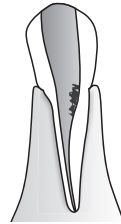

2

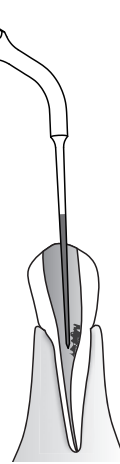

3

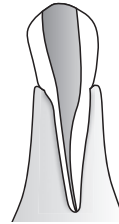

Demo Video

MODE: E
POWER

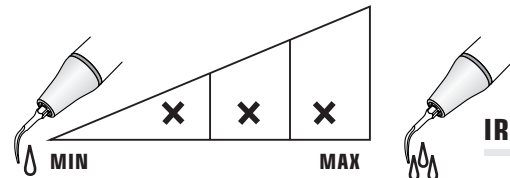
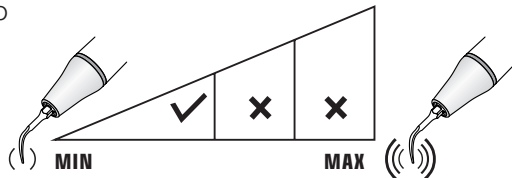

IRRIGATION

E15(ED15/ES15)

Instrument for the removal of broken files inside the root canal. The length of tip slender part is (16mm).

If possible place the patient's head in a position where the root canal is horizontal with a downward inclination. Rotate the tip of the instrument counterclockwise around the broken part until it is picked out from the root canal.

To avoid push the broken file deeper into the root canal, do not use pressure to the instrument in the axial direction.

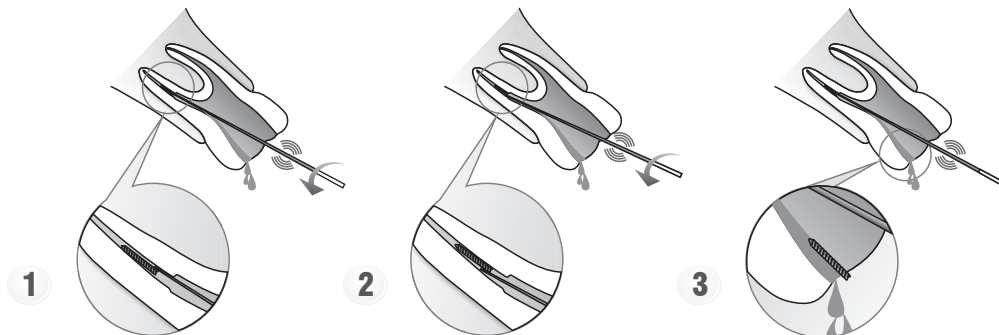
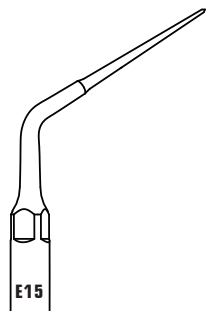

Demo Video

MODE: E
POWER

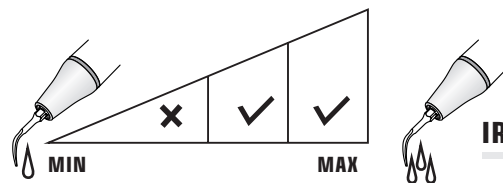
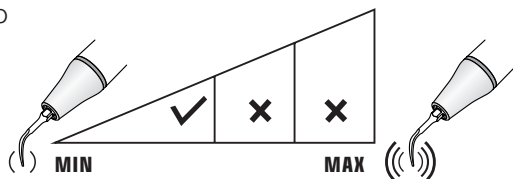

IRRIGATION

E15D(ED15D)

Diamond-coated(40um) instrument for removing the calcification and bad filling material in the root canal during the root canal retreatment. The length of the diamond-coated on tip is (10mm). With irrigation.

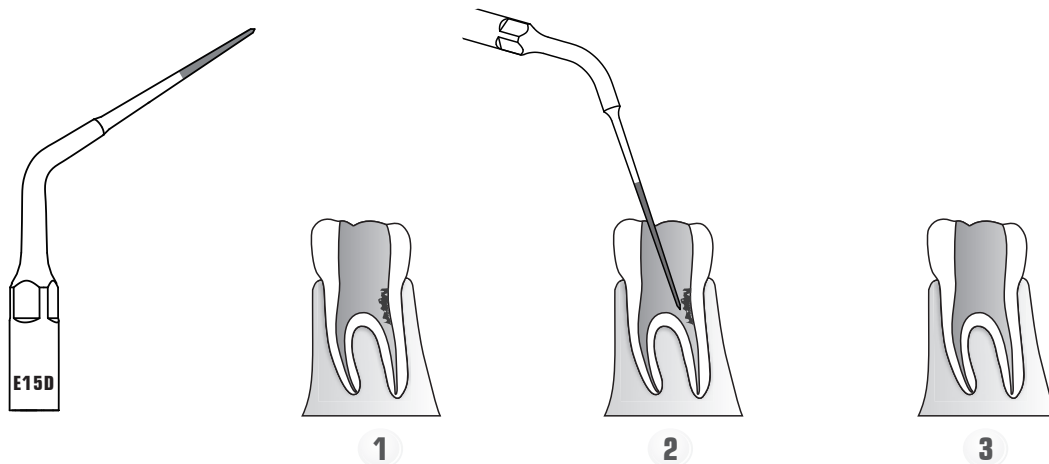

Demo Video

MODE: E

POWER

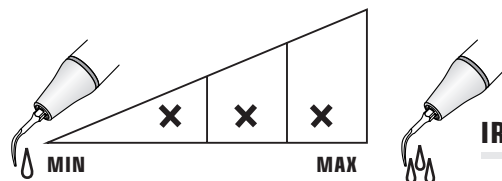
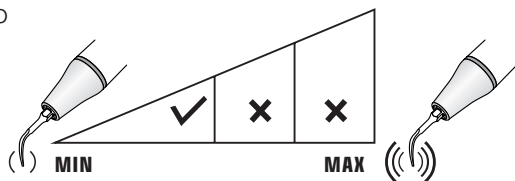

ED17

Function: Used for root canal detection, pulp chamber cleaning, and orifice opening.

Features: The tip has 15 micro-washers, and it is of good cutting performance.

Back and forth motion of tip brings more efficient operation.

In the case of waterless operation, select the mode of "Work for 5~10 seconds and then stop for 2 seconds", and open water every 60 seconds for cooling and rinsing.

Note:

(1) Due to the strong cutting performance of the tip, in order to prevent the penetration of the medullary cavity, it is recommended to use with a root canal microscope.

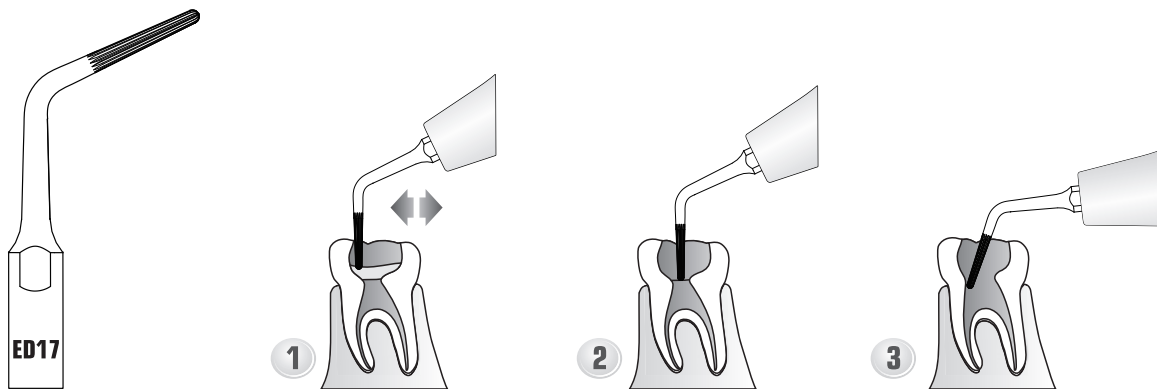

MODE: E
POWER

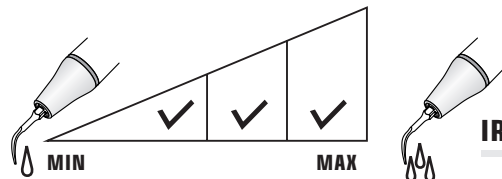
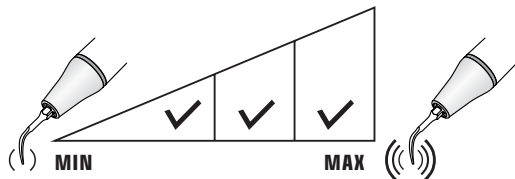

IRRIGATION

ED18

Function: Used to determine the position of the root canal, remove the dentin, calcification and loose crown at the 1/3 crown of the root canal.

Features: The tip has 12 micro-washers, and it is of good cutting performance.

Back and forth motion of tip brings more efficient operation.

In the case of waterless operation, select the mode of "Work for 5~10 seconds and then stop for 2 seconds", and open water every 60 seconds for cooling and rinsing.

Note:

(1) Due to the strong cutting performance of the tip, in order to prevent the penetration of the medullary cavity, it is recommended to use with a root canal microscope.

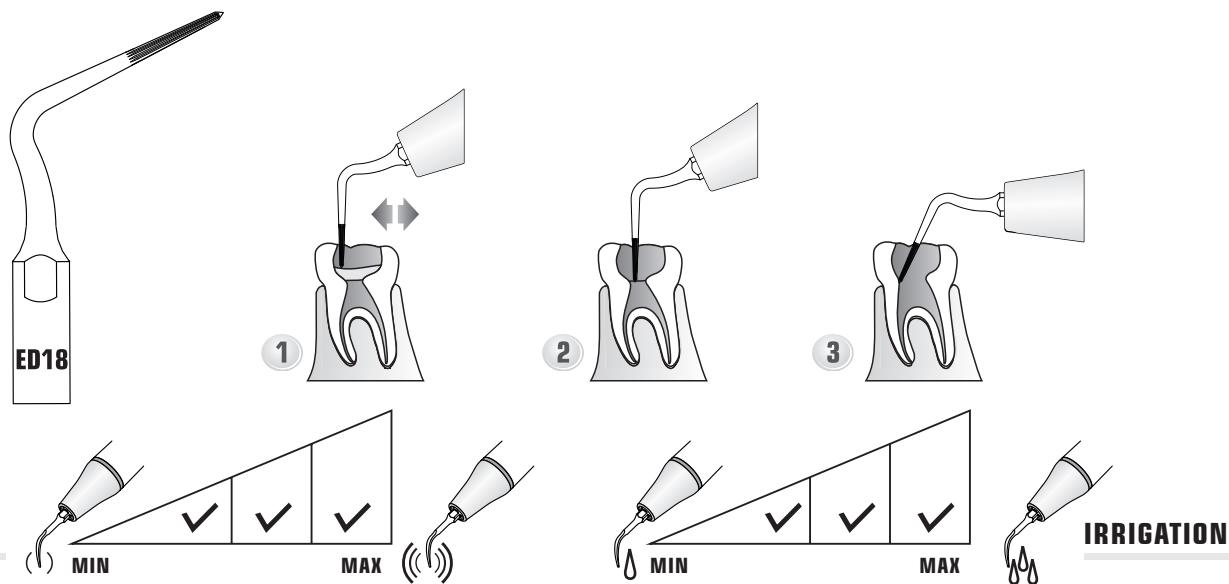

ED19D

Used for efficient apex modification in retropreparation. The length of diamond-coated part is 3mm, and the diameter of sand is 30 μ m. Normally used for retropreparation of front teeth.

Use:

Used in E mode of D600; recommended power level: level 1~7;

Used in E mode of S6; recommended power level: level 1~10.

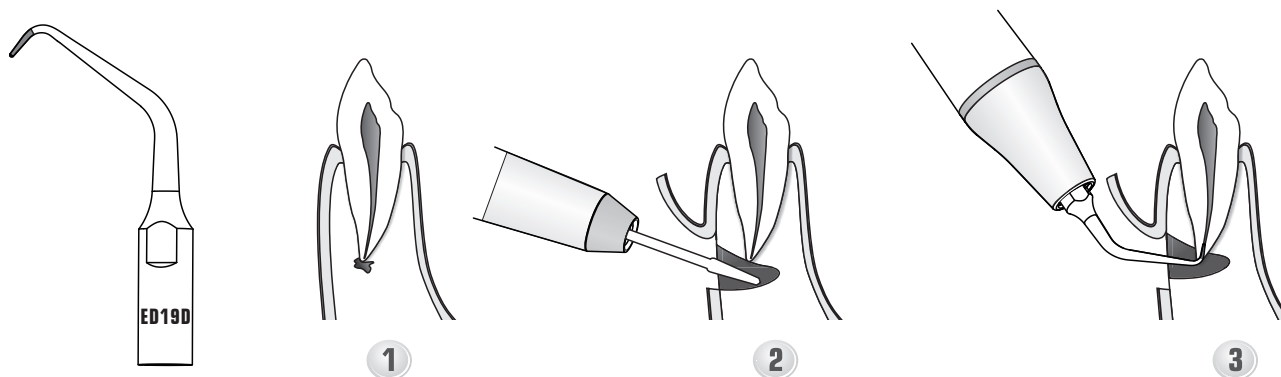

MODE: E
POWER

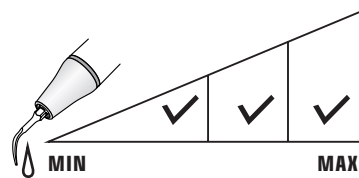
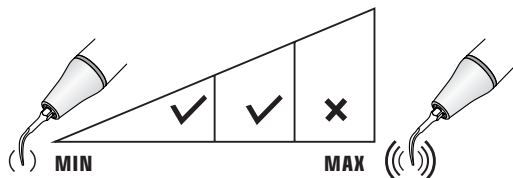

IRRIGATION

ED20D

Used for efficient apex modification in retropreparation. The length of diamond-coated part is 6mm, and the diameter of sand is 30 μ m. Normally used for retropreparation of front teeth.

Use:

Used in E mode of D600; recommended power level: level 1~7;

Used in E mode of S6; recommended power level: level 1~10.

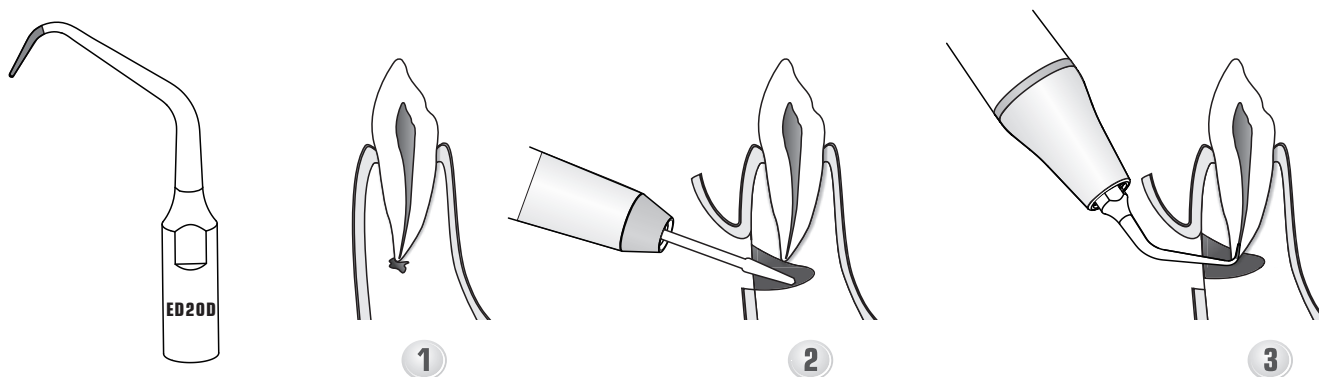

MODE: E
POWER

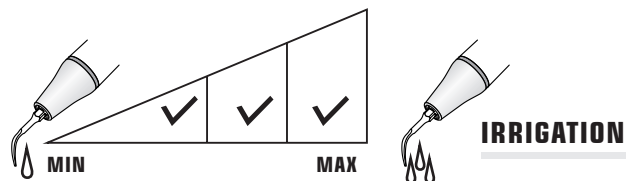
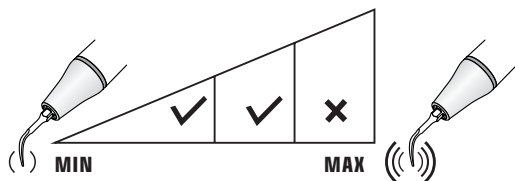

ED21LD

Used for efficient apex modification in retropreparation. The length of diamond-coated part is 3mm, and the diameter of sand is 30 μ m. Bent to left. Used in premolars and molars.

Use:

Used in E mode of D600; recommended power level: level 1~6;

Used in E mode of S6; recommended power level: level 1~9.

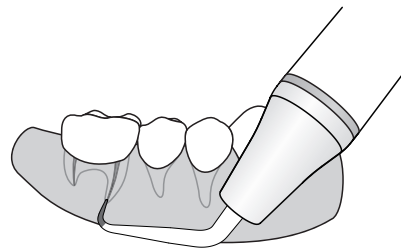
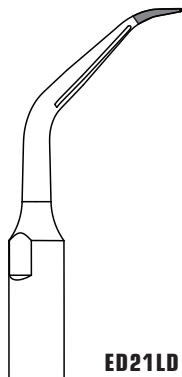

MODE: E
POWER

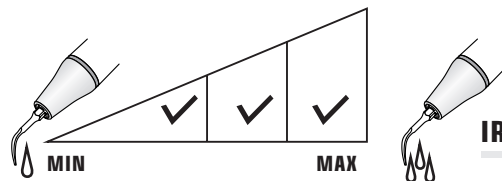
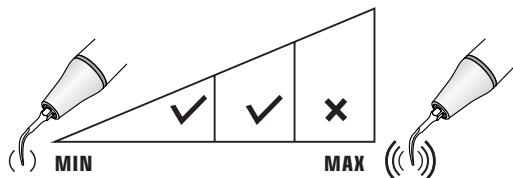

IRRIGATION

ED21RD

Used for efficient apex modification in retropreparation. The length of diamond-coated part is 3mm, and the diameter of sand is 30 μ m. Bent to right. Used in premolars and molars.

Use:

Used in E mode of D600; recommended power level: level 1~7;

Used in E mode of S6; recommended power level: level 1~10.

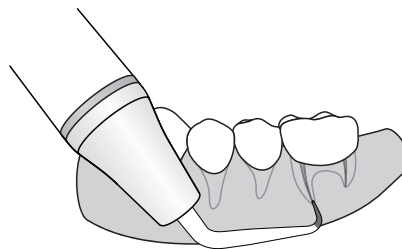
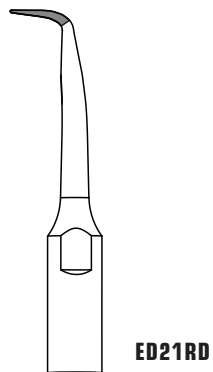

MODE: E
POWER

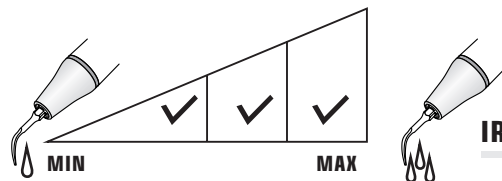
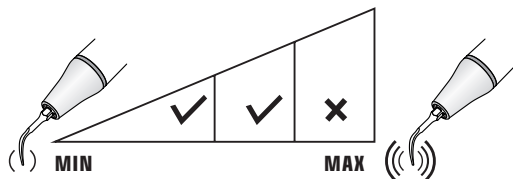

IRRIGATION

ED22D

Used for efficient apex modification in retropreparation. The length of diamond-coated part is 4mm, and the diameter of sand is 30 μ m. Used in molar teeth.

Use:

Used in E mode of D600; recommended power level: level 1~7;

Used in E mode of S6; recommended power level: level 1~10.

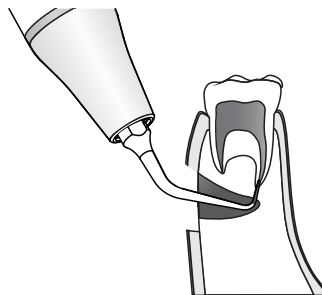
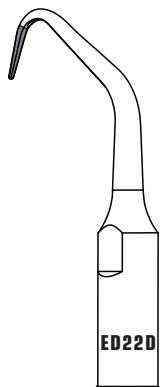

MODE: E
POWER

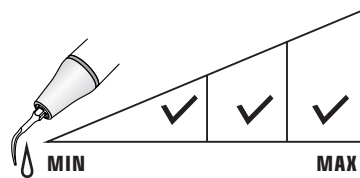
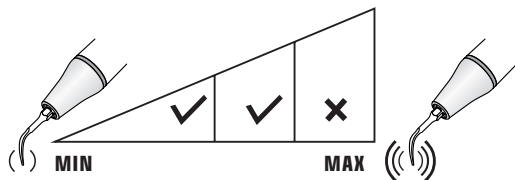

IRRIGATION

ED23D

Used for efficient apex modification in retropreparation. The length of diamond-coated part is 9mm, and the diameter of sand is 30 μ m. Mainly used in front teeth. Used for complicated case, and it can prepared to 9mm in retropreparation operation.

Use:

Used in E mode of D600; recommended power level: level 1~7;

Used in E mode of S6; recommended power level: level 1~10.

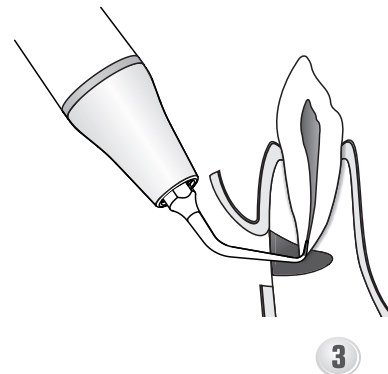
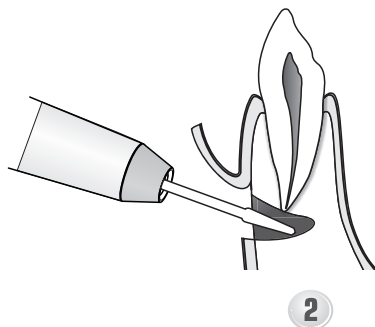
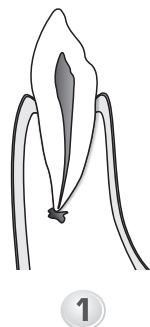
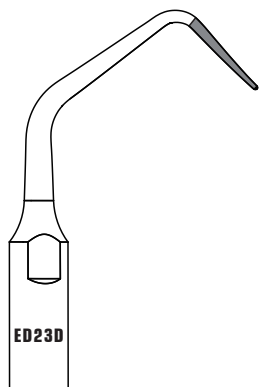

MODE: E
POWER

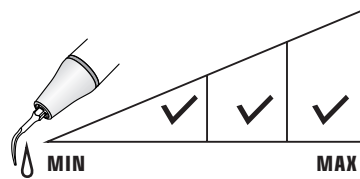
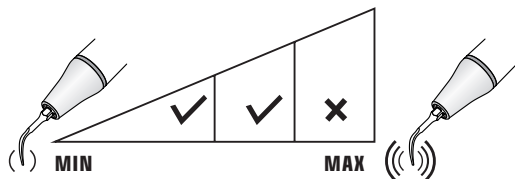

IRRIGATION

ED24D

Used for efficient apex modification in retropreparation. The length of diamond-coated part is 5mm, and the diameter of sand is 30 μ m. Mainly used in front teeth.

Use:

Used in E mode of D600; recommended power level: level 1~7;

Used in E mode of S6; recommended power level: level 1~10.

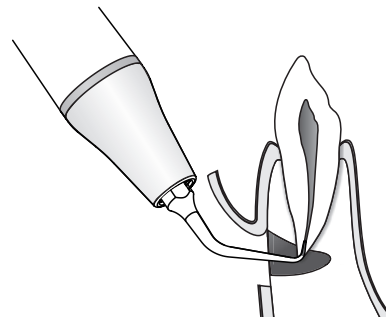
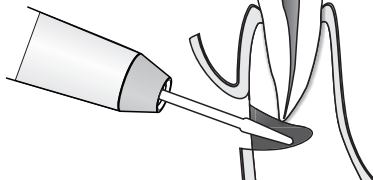
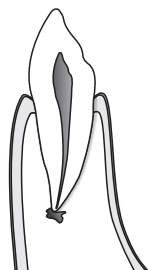

MODE: E
POWER

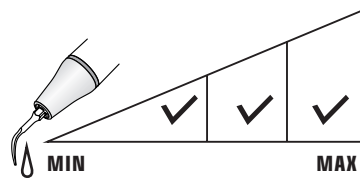
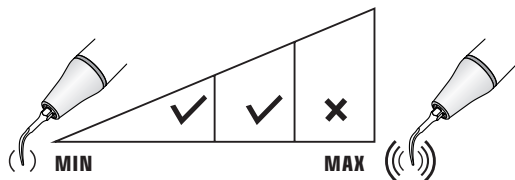

IRRIGATION

ED25LD

Used for efficient apex modification in retropreparation. The length of diamond-coated part is 5mm, and the diameter of sand is 30 μ m. Bent to left. Used in premolars and molars.

Use:

Used in E mode of D600; recommended power level: level 1~7;

Used in E mode of S6; recommended power level: level 1~10.

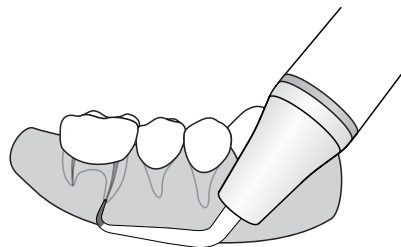
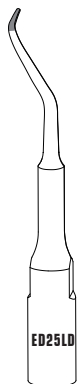

MODE: E
POWER

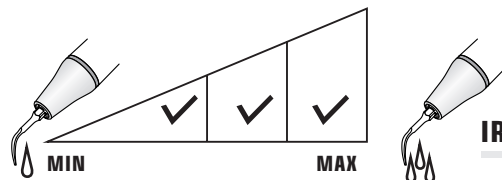
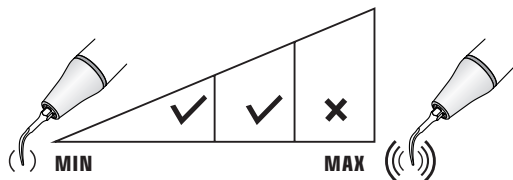

IRRIGATION

ED25RD

Used for efficient apex modification in retropreparation. The length of diamond-coated part is 5mm, and the diameter of sand is 30 μ m. Bent to right. Used in premolars and molars.

Use:

Used in E mode of D600; recommended power level: level 1~7;

Used in E mode of S6; recommended power level: level 1~10.

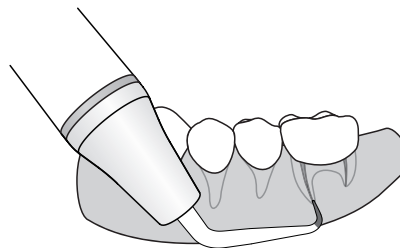
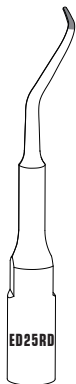

MODE: E
POWER

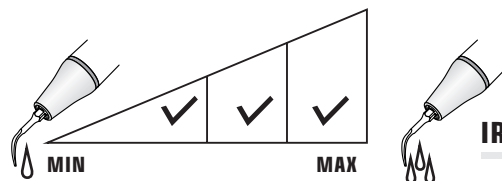
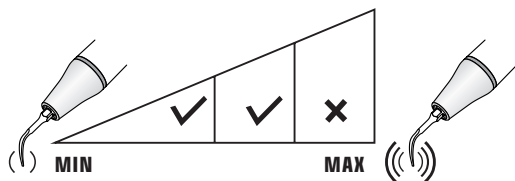

IRRIGATION

EGO(ED60)

Features: Minimally invasive irrigation; the working part is spiral but not sharp, with basically no cutting ability, effectively avoiding the root canal shape from being destroyed, bringing efficient and safe operation.

Irrigating operation: Put the irrigating tip into the root canal, try to keep the tip unstressed, start the device for 20 seconds and then stop to clean the root canal. Generally, a root canal needs to be irrigated 3×20 seconds.

Recommended service life: 30 ~ 50 root canals

Note: (1) In order to ensure the service life of the tip, it is recommended to use it according to the recommended method: first perform the external debugging, start the foot pedal under power level 1, ensure the water output is normal, and adjust the power within the power level limit (level 1~6) according to individual need to ensure that the water output can reach the tip end (the water can reach the tip end through adjusting water volume). After all the above steps, start root canal irrigation.

(2) During irrigation, in order to avoid instrument fracture, please prevent tip from getting stuck and vibrating in root canal.

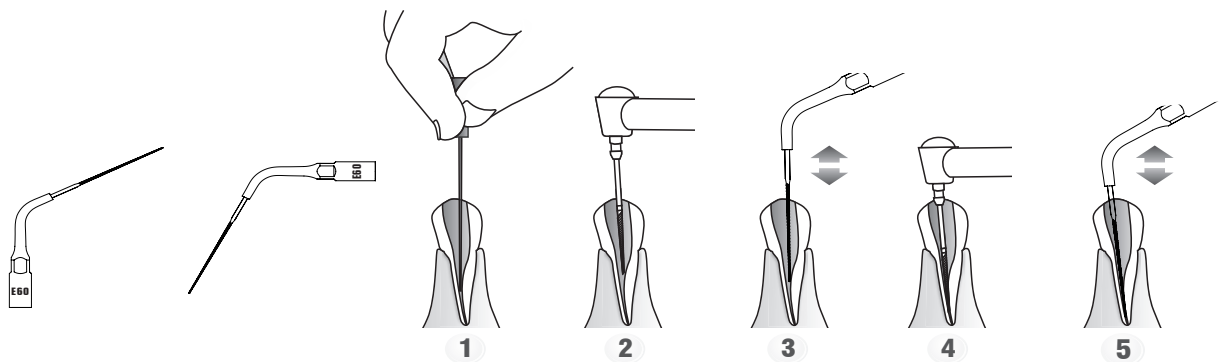

MODE: E
POWER

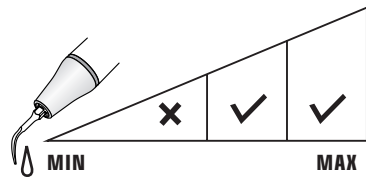
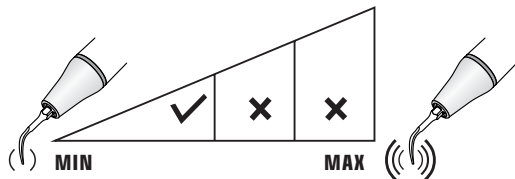

IRRIGATION

E62(ED62)

Function: Used for irrigation of root canal after root canal preparation.

Dimensions: $\varnothing 0.3\text{mm}$; taper 0%. Working part length: 16mm

Features: Minimally invasive irrigation; the surface of working part is smooth, with cutting ability, effectively avoiding the root canal shape from being destroyed, bringing safer operation.

Irrigating operation: Put the irrigating tip into the root canal, try to keep the needle unstressed, start the device for 20 seconds and then stop to clean the root canal. Generally, a root canal needs to be irrigated 3×20 seconds.

Recommended service life: 30 ~ 50 root canals

Note: (1) In order to ensure the service life of the tip, it is recommended to use it according to the recommended method: first perform the external debugging, start the foot pedal under power level 1, ensure the water output is normal, and adjust the power within the power level limit (level 1~3) according to individual need to ensure that the water output can reach the tip end (the water can reach the tip end through adjusting water volume). After all the above steps, start root canal irrigation.

(2) During irrigation, in order to avoid instrument fracture, please prevent tip from getting stuck and vibrating in root canal.

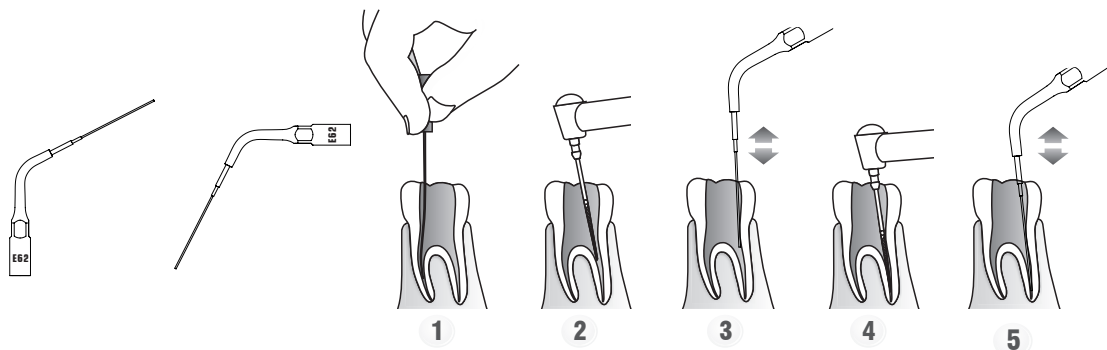

MODE: E
POWER

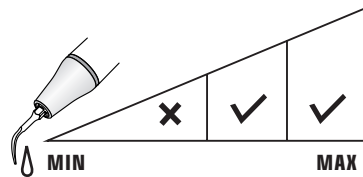
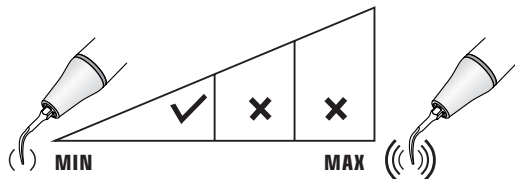

IRRIGATION

E66(ED66)

Function: Used for irrigation of root canal after root canal preparation, so as to rinse out the debris.

Dimensions: Diameter of file tip: \varnothing 0.15mm; taper 2%; length of thread working part: 16mm

Features: The working part has a sharp K-shaped spiral shape, which has strong cutting ability. It can effectively clean out the debris in root canal by using it under low power.

Note: (1) In order to ensure the service life of the tip, it is recommended to use it according to the recommended method: first perform the external debugging, start the foot pedal under power level 1, ensure the water output is normal, and adjust the power (level 1~3) according to individual need to ensure that the water output can reach the tip end (the water can reach the tip end through adjusting water volume). After all the above steps, start root canal irrigation. (2) During irrigation, in order to avoid instrument fracture, please prevent tip from getting stuck and vibrating in root canal. (3) The top edge of ED66 tip is sharp. Please pay special attention to the operation at high power during the irrigation. Otherwise it will cause non-therapeutic damage to the root canal wall.

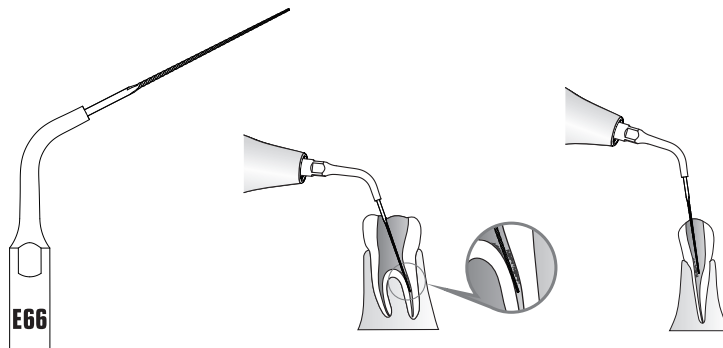

MODE: E
POWER

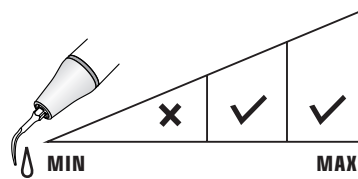
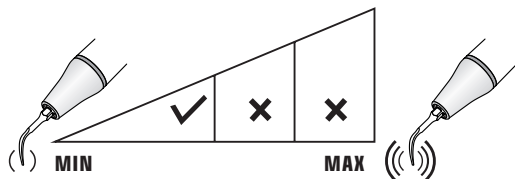

IRRIGATION

SB1 (SBD1)

Diamond-coated(85µm) instrument for removing the caries on occlusal surface of teeth and dental neck.

Place the instrument on the pit and move slowly into it with light pressure.

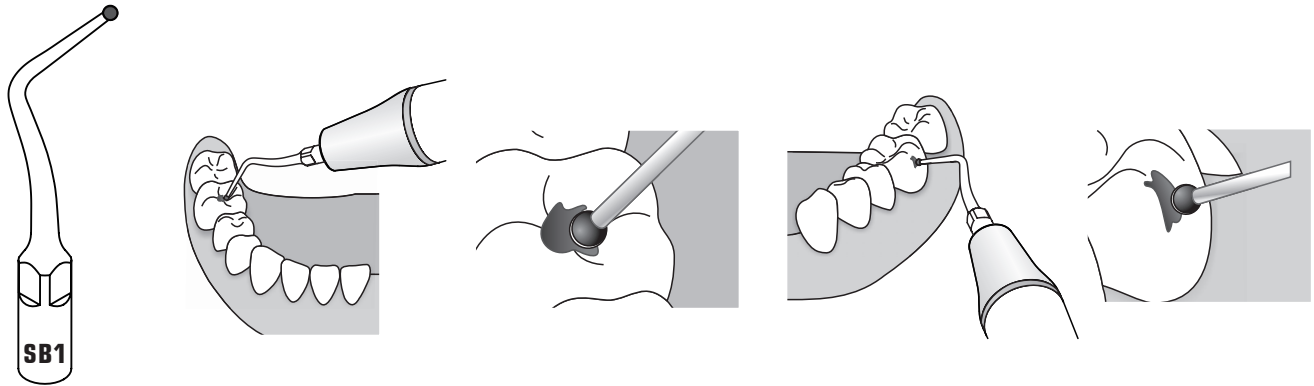

Demo Video

MODE: P
POWER

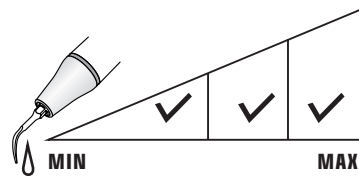
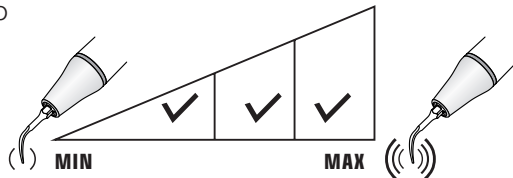

IRRIGATION

SB2 (SBD2)

Diamond-coated(85µm) instrument for removing the caries on Mesial surface of the adjacent teeth.

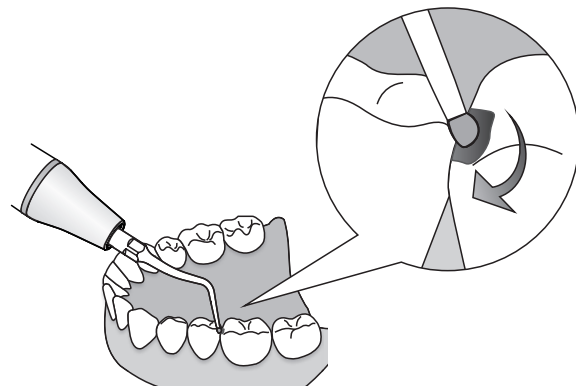
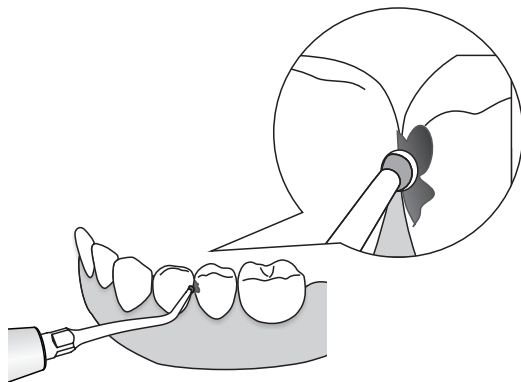
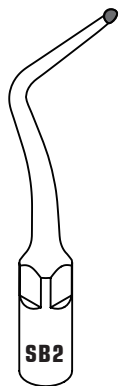

Demo Video

MODE: P

POWER

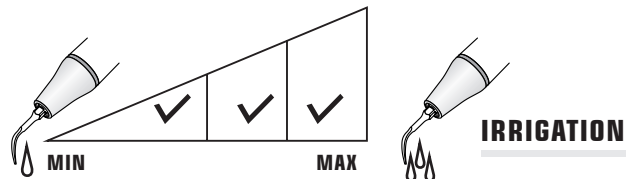
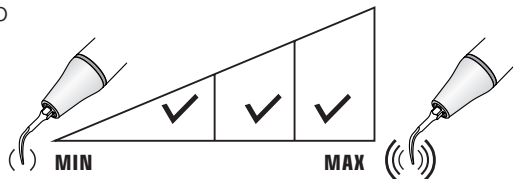

IRRIGATION

SB3 (SBD3)

Diamond-coated(85µm) instrument for removing the caries on Distal surface of the adjacent teeth.

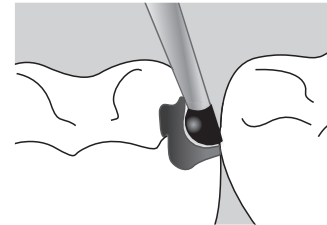
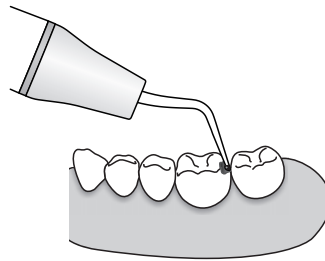
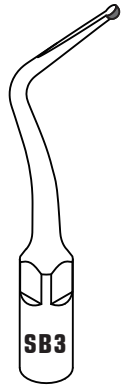

Demo Video

MODE: P
POWER

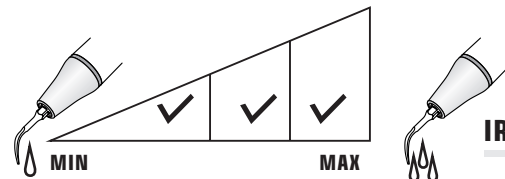
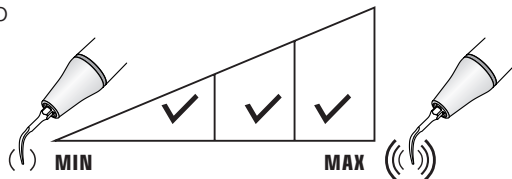

IRRIGATION

SBL(SBDL)

Diamond-coated(85µm) instrument for removing the dental caries, it will not hurt the adjacent teeth from right to left 45 degree.

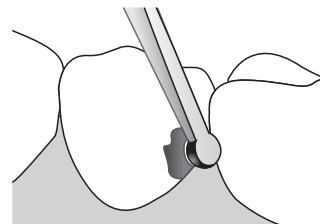
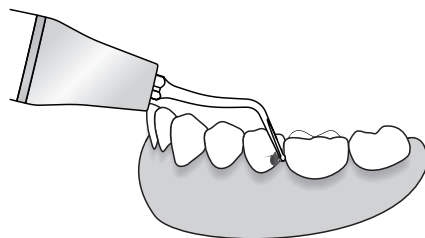
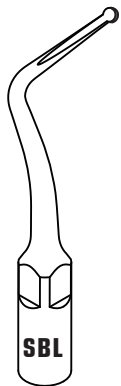

Demo Video

MODE: P

POWER

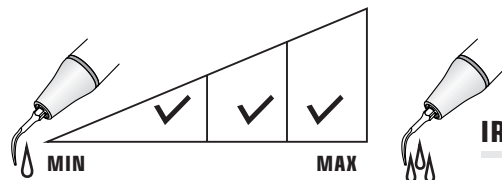
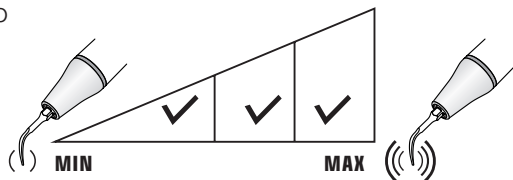

IRRIGATION

SBR(SBDR)

Diamond-coated(85µm) instrument for removing the dental caries, it will not hurt the adjacent teeth from left to right 45 degree.

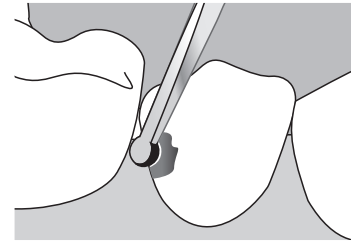
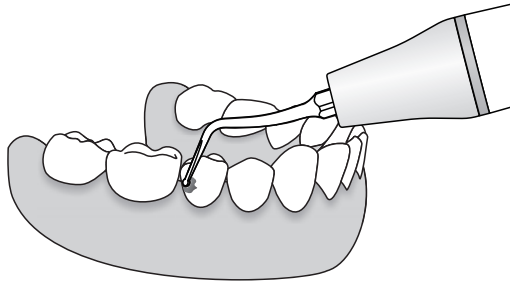
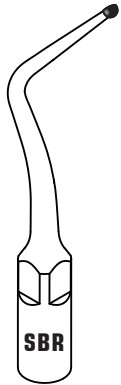

Demo Video

MODE: P
POWER

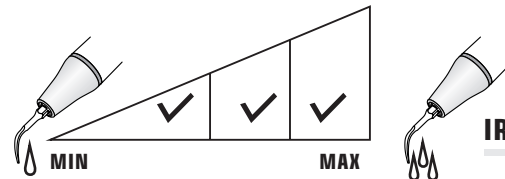
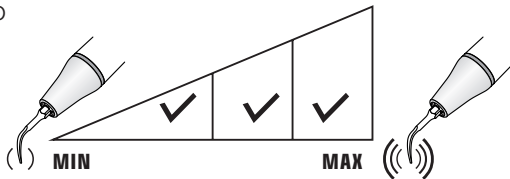

IRRIGATION

SB4 (SBD4)

Used to remove dental caries at upper and lower occlusal surfaces and neck of teeth.

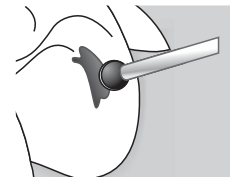
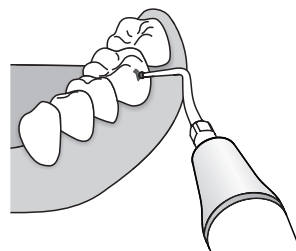
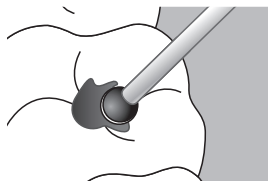
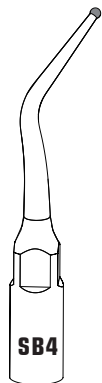

MODE: P
POWER

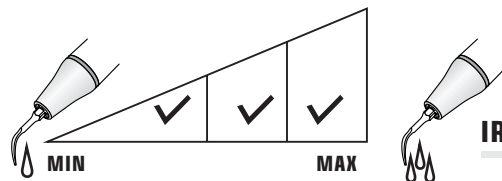
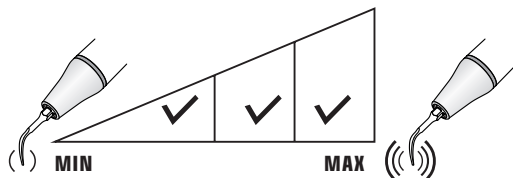

IRRIGATION

SB5 (SBD5)

Used to remove the mesial surface caries of adjacent teeth. Diamond-coated tip head (90µm) (except internal part); the adjacent teeth will not be hurt during mesial cavity preparation.

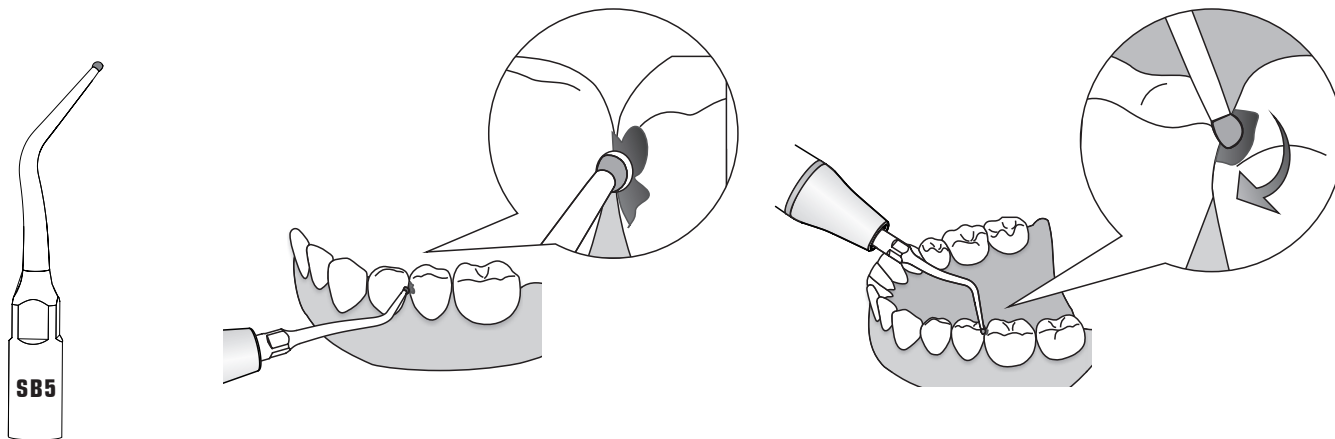

MODE: P
POWER

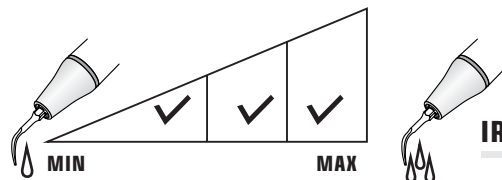
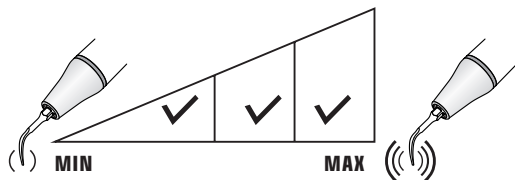

IRRIGATION

SB6 (SBD6)

Used to remove the mesial surface caries of adjacent teeth. Diamond-coated tip head (90 μ m) (except external part); the adjacent teeth will not be hurt during mesial cavity preparation.

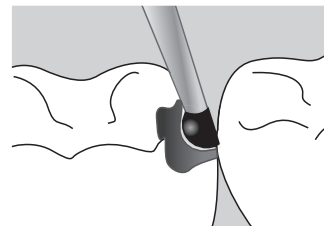
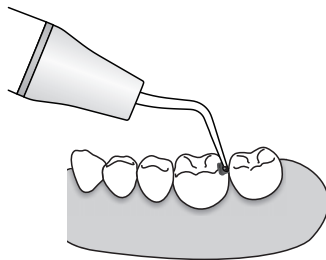
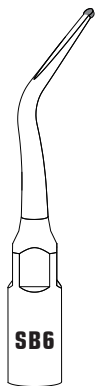

MODE: P
POWER

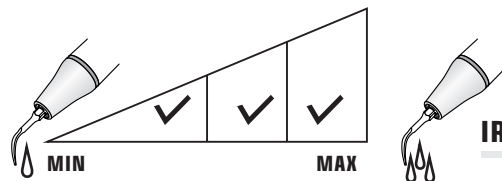
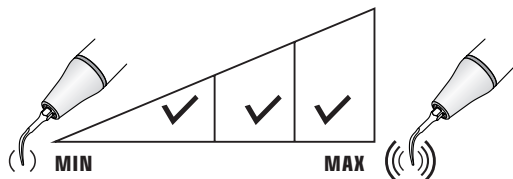

IRRIGATION

SB7L (SBD7L)

Used to remove the proximal surface caries. Diamond-coated (90µm) tip with round head. The adjacent teeth will not be hurt while accessing the caries part in 45° from left side.

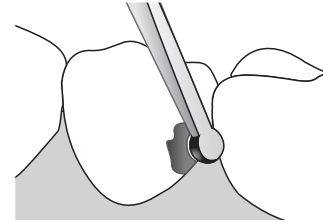
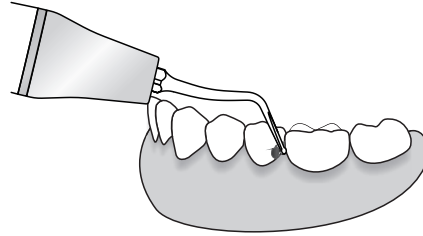
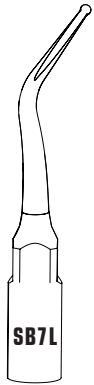

MODE: P
POWER

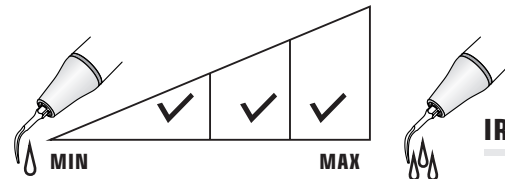
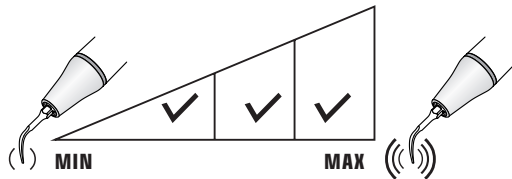

IRRIGATION

SB7R (SBD7R)

Used to remove the proximal surface caries. Diamond-coated (90µm) tip with round head. The adjacent teeth will not be hurt while accessing the caries part in 45° from right side.

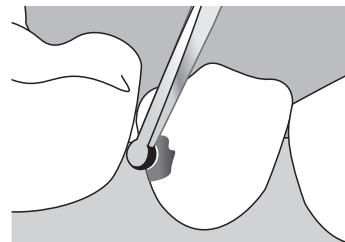
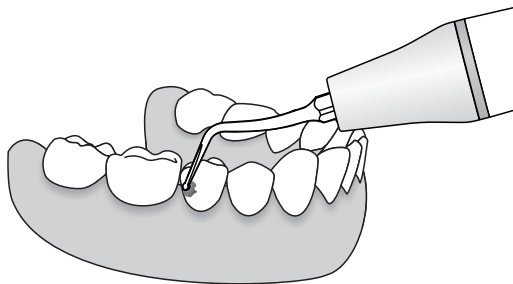
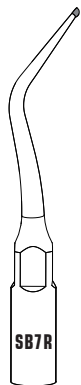

MODE: P
POWER

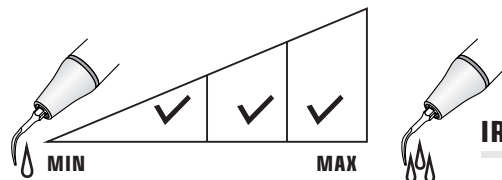
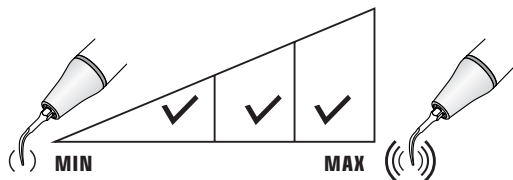

IRRIGATION

GK1

Removal of supragingival deposits in all quadrants.

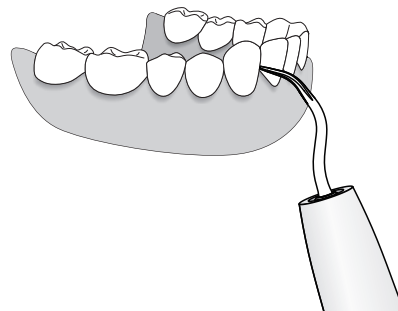
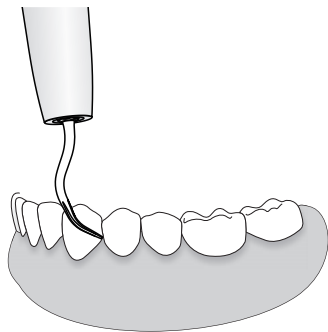

POWER

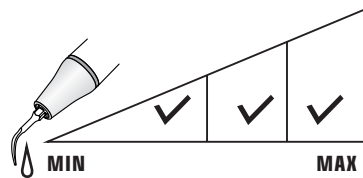
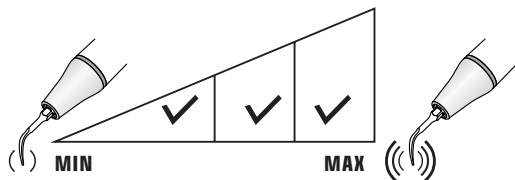

IRRIGATION

GK2

Removal of supragingival heavy calculus and plaque.

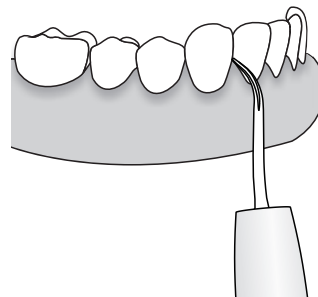
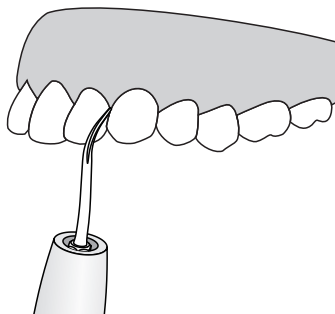
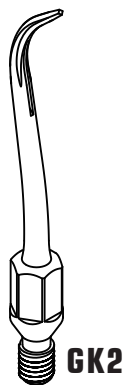

POWER

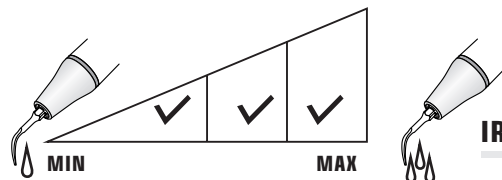
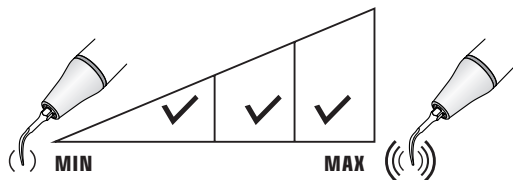

IRRIGATION

GK3

Removal of supragingival calculus, interdental calculus and calculus at the neck of the teeth.

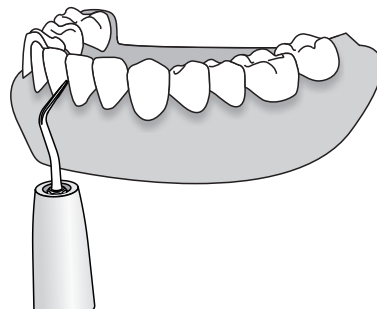
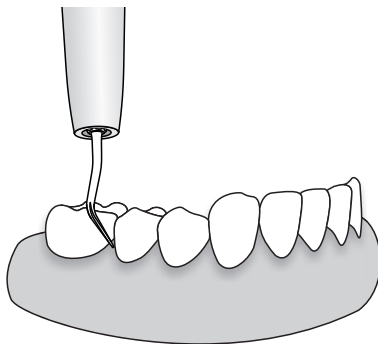

POWER

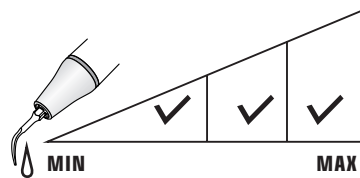
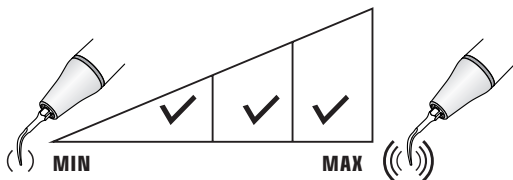

IRRIGATION

GK4

Removal of supragingival deposits, including the interproximal and sulcus areas.

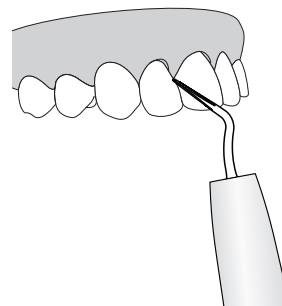
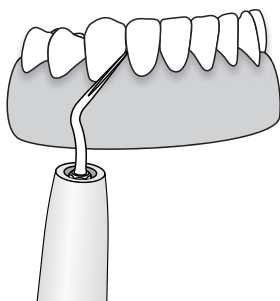
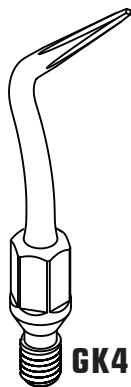

POWER

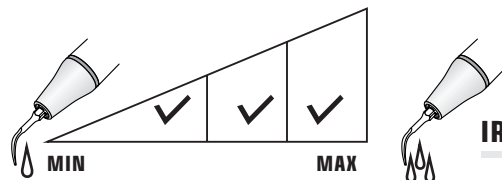
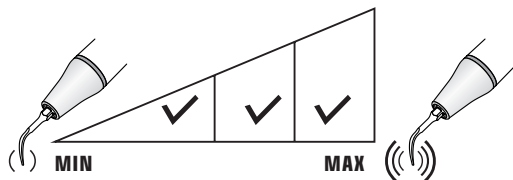

IRRIGATION

GK5

Removal of subgingival calculus.

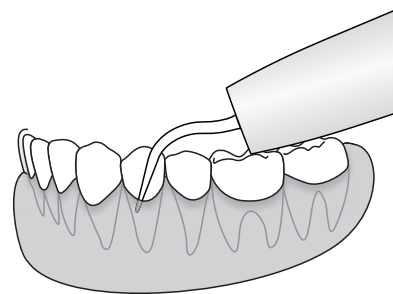
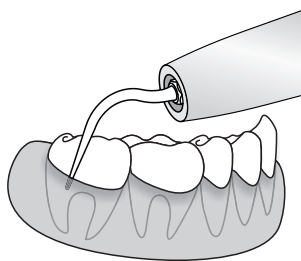
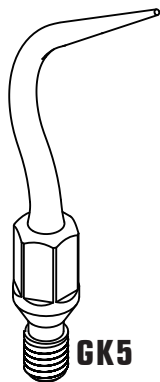

POWER

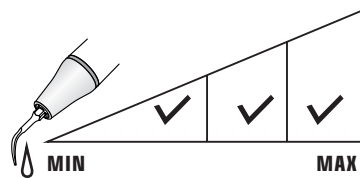
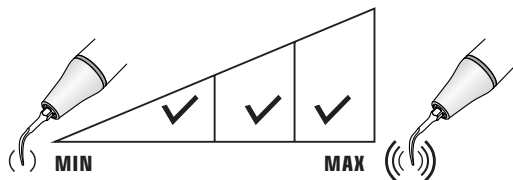

IRRIGATION

GK6

Left-angled, removal of subgingival calculus.

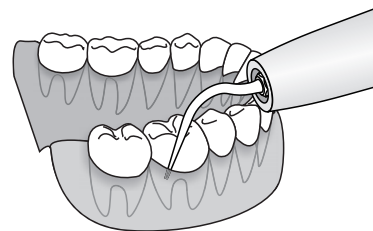
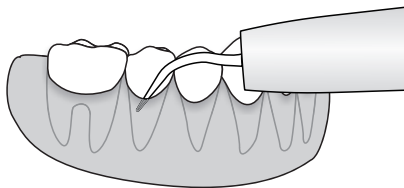
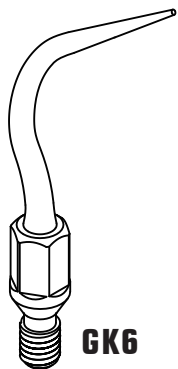

POWER

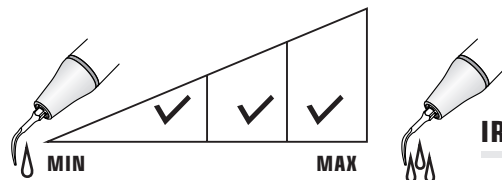
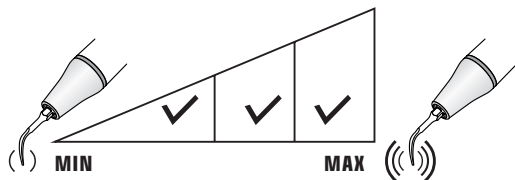

IRRIGATION

GK7

Right-angled, removal of subgingival calculus.

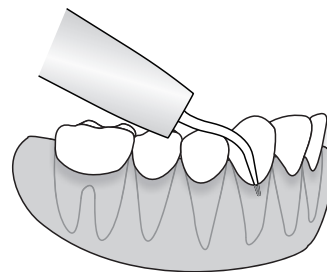
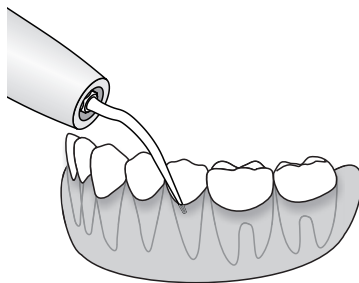
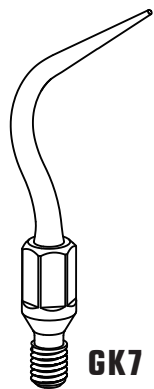

POWER

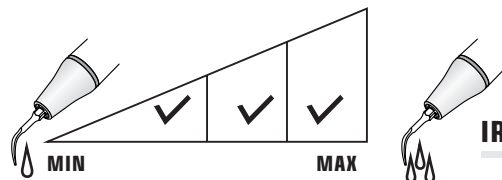
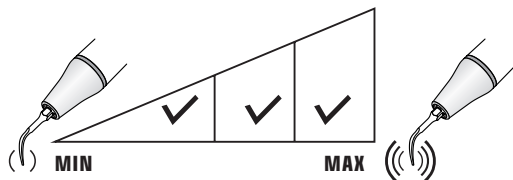

IRRIGATION

GK20

There are diamonds coated (120um grit) on the head of the tip for dentin abrading.

It's used for "supragingival shoulder" preparation after the completion of the preparation of the "subgingival shoulder" with bur.

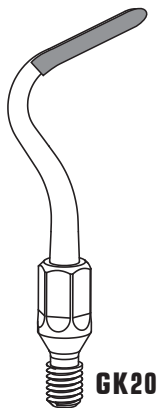

GK20

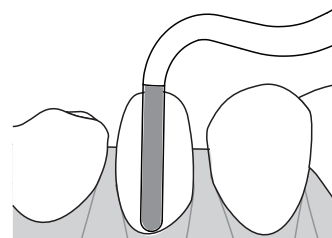
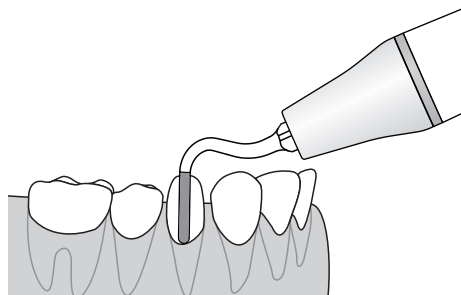

POWER

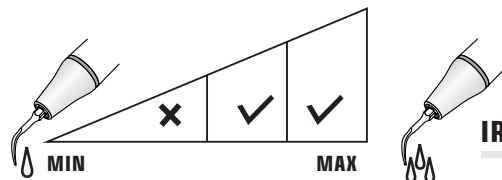
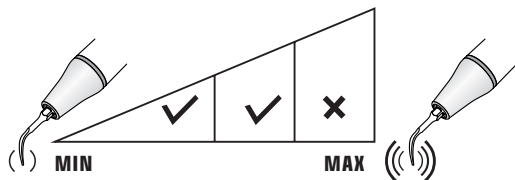

IRRIGATION

GK21

There are diamonds coated (50um fine sand) on the head of the tip for dentin abrading, mainly used for polishing of prepared supragingival shoulder and subgingival shoulder.

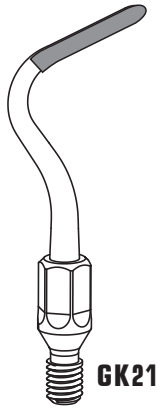

GK21

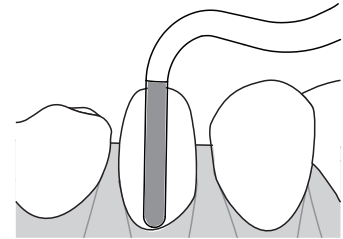
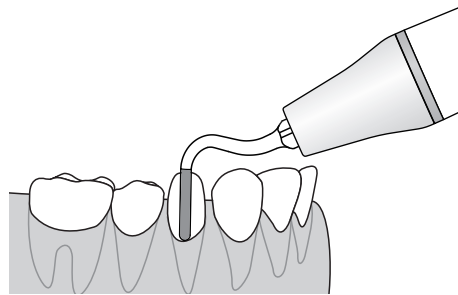

POWER

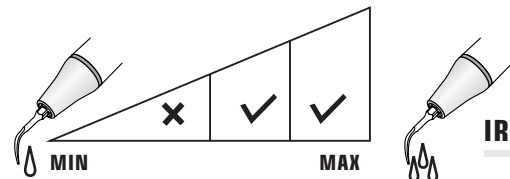
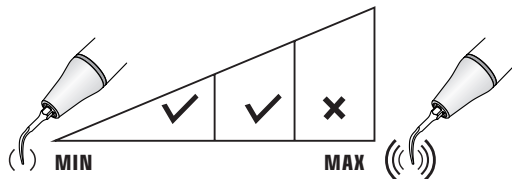

IRRIGATION

GK60

Removal of supragingival deposits in all quadrants.

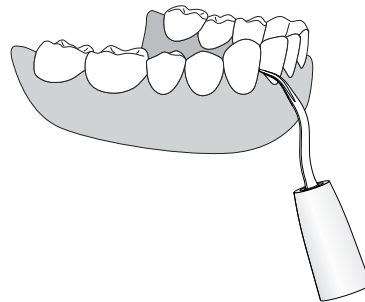
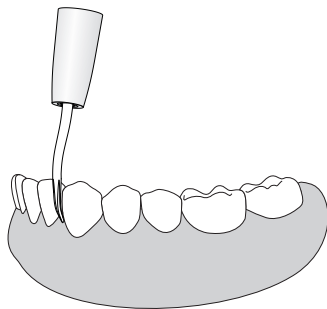
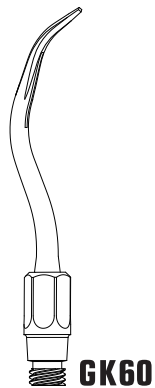

POWER

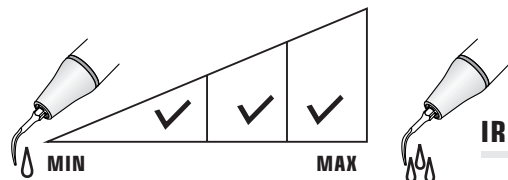
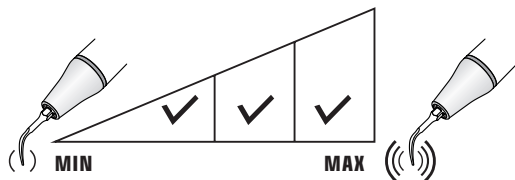

IRRIGATION

GK61

Removal of supragingival heavy calculus and plaque.

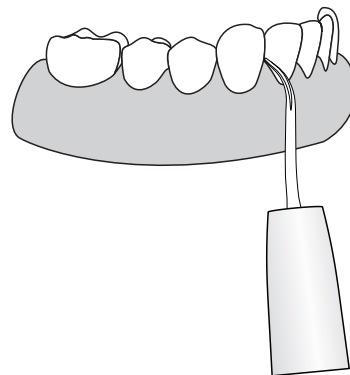
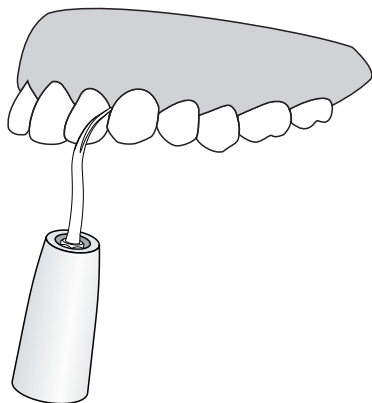
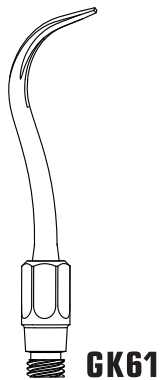

POWER

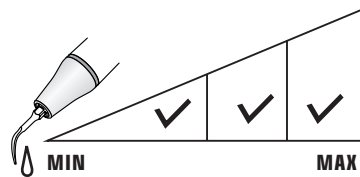
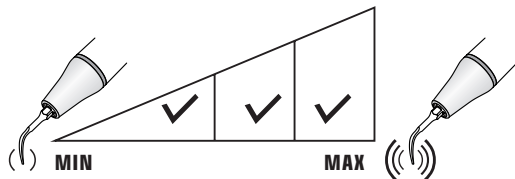

IRRIGATION

GK62

Removal of supragingival calculus, interdental calculus and calculus at the neck of the teeth.



GK62

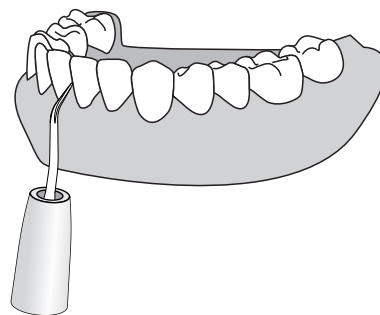
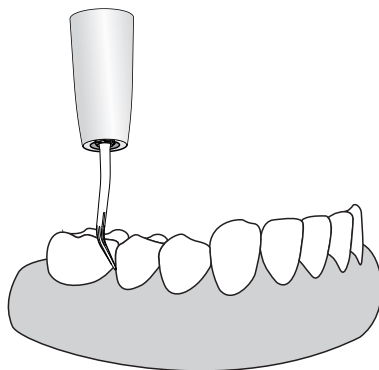

POWER

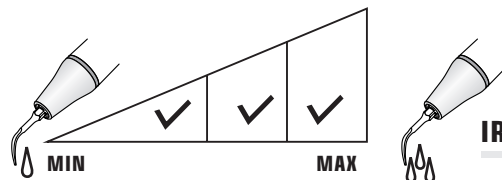
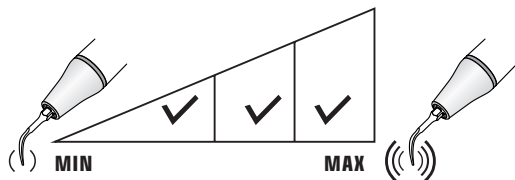

IRRIGATION

GC1

Removal of supragingival deposits in all quadrants.

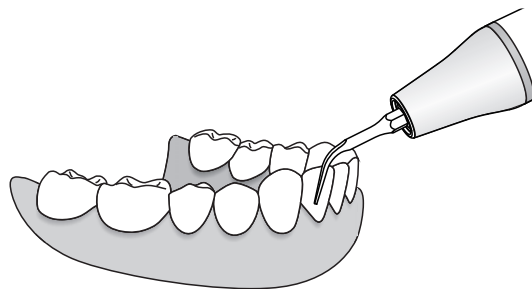
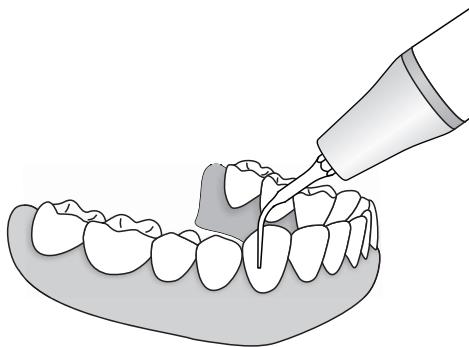
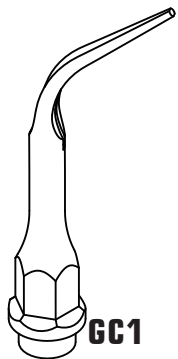

MODE: G
POWER

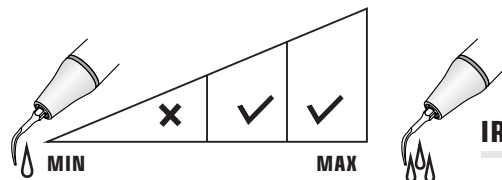
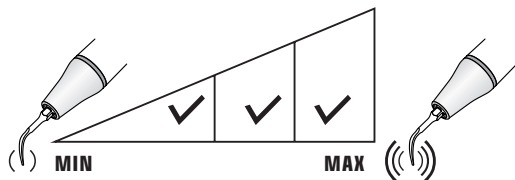

IRRIGATION

GC2

Removal of supragingival calculus, interdental calculus and calculus at the neck of the teeth.

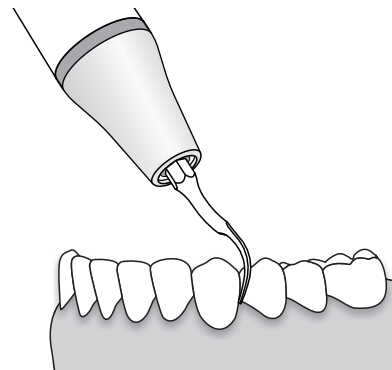
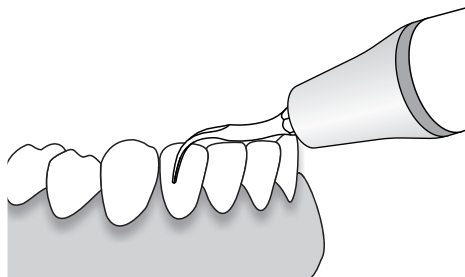

MODE: G
POWER

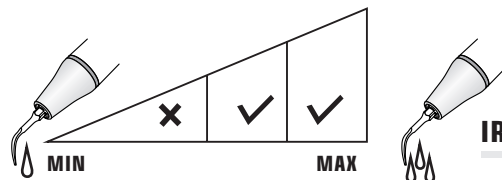
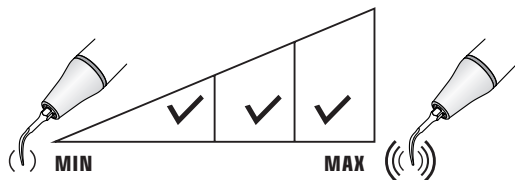

IRRIGATION

PC1

Removal of subgingival calculus, including the interproximal and sulcus areas.

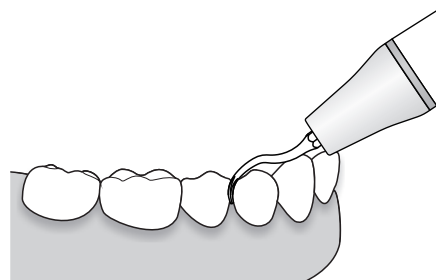
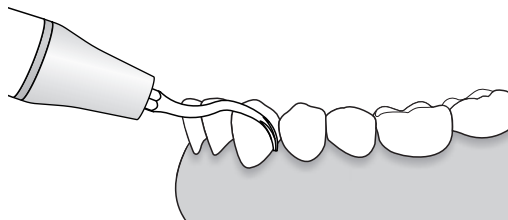
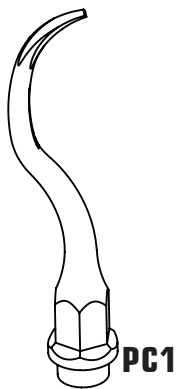

MODE: P
POWER

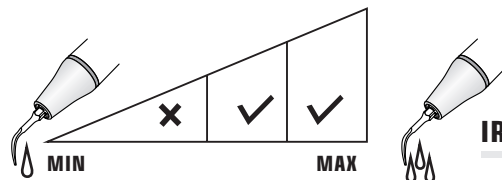
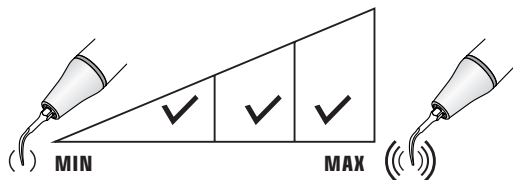

IRRIGATION

PC60

Recommended for the treatment of interproximal spaces and for supragingival scaling.

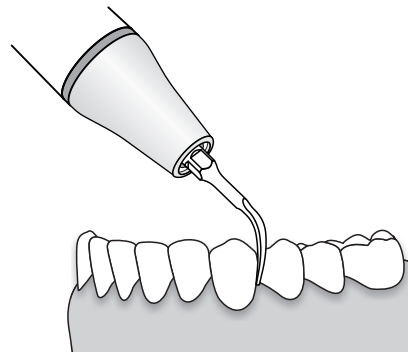
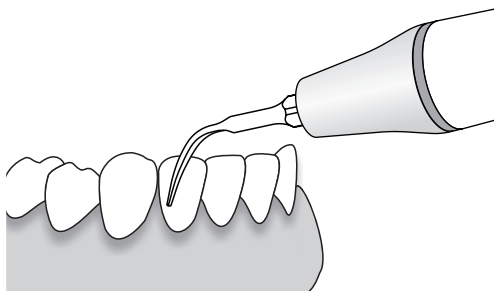
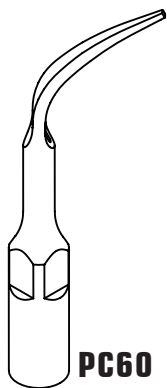

MODE: P
POWER

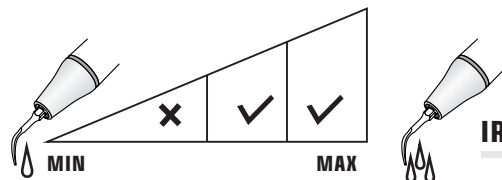
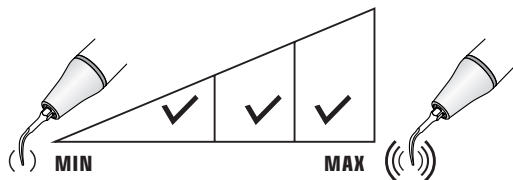

IRRIGATION

PC61

Function: used to remove the calculus at shallow periodontal pocket and treat the adjacent tooth surface and ditch area.

Features: The tip is flat and wide, which can be used to clean the teeth surface at subgingival 1/4 and the supragingival part.

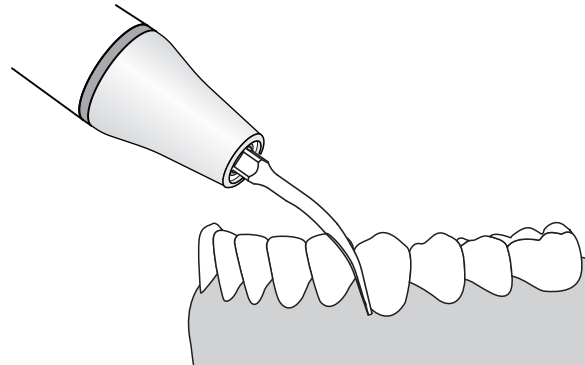
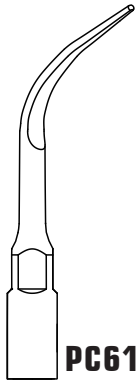

MODE: P
POWER

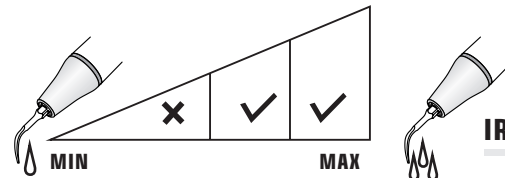
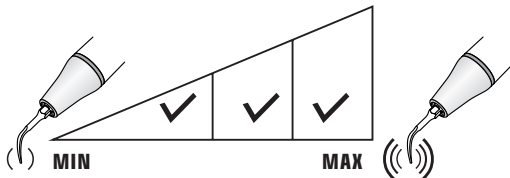

IRRIGATION

PC62

Recommended for cleaning and irrigating of periodontal deep pockets.

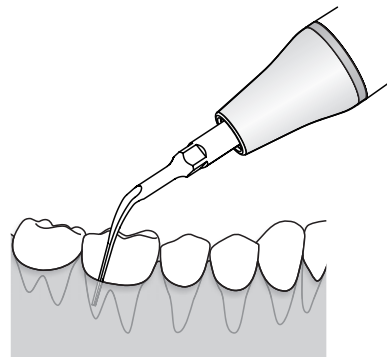
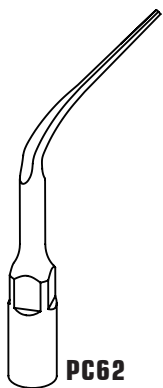

**MODE: P
POWER**

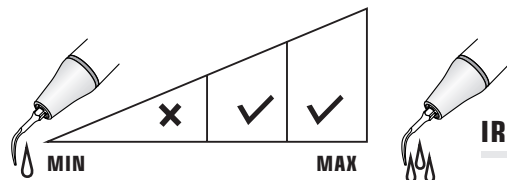
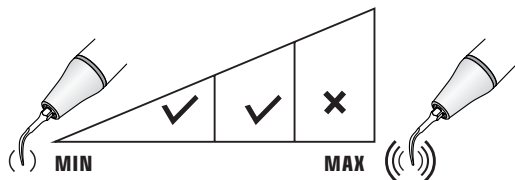

IRRIGATION

A1

Removal of supragingival deposits, including the interproximal and sulcus areas.

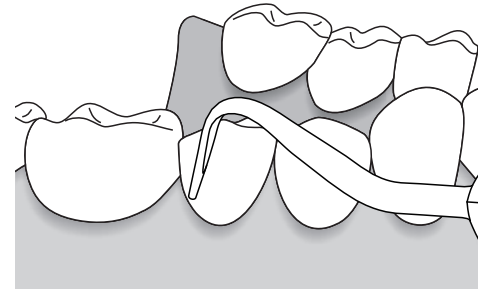
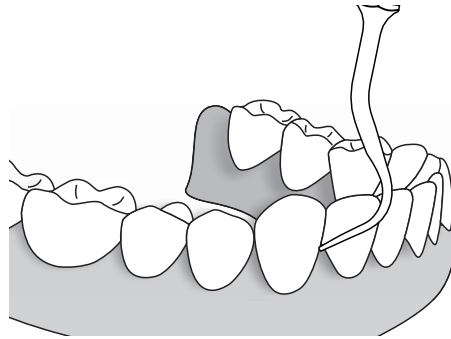
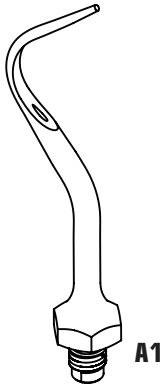

POWER

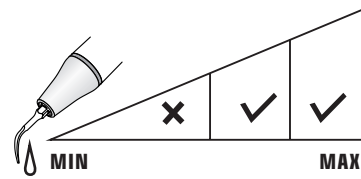
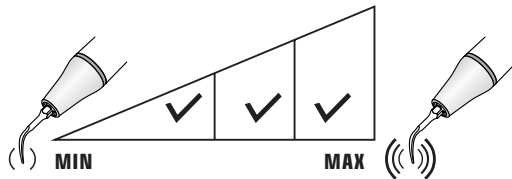

IRRIGATION

A2

Removal of supragingival deposits in all quadrants, including neck and adjacent part of the teeth.

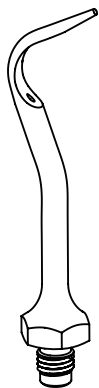

A2

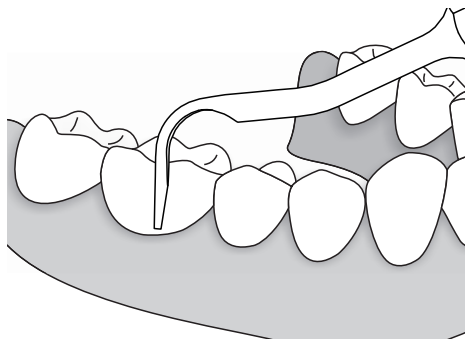

POWER

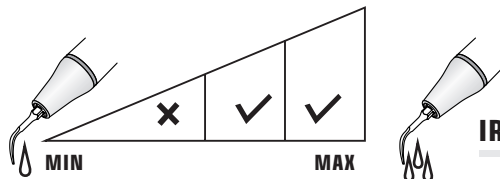
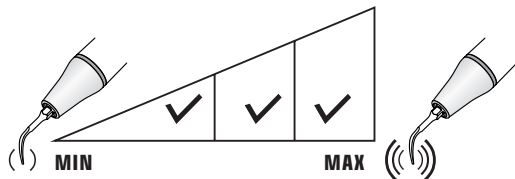

IRRIGATION

Ultrasonography Tip

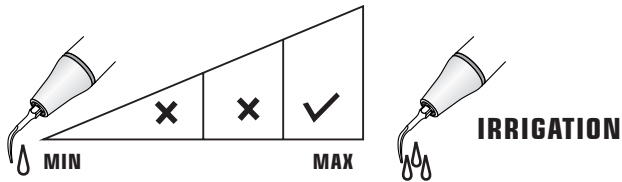

Meaning of the above symbols:

Water volume

The first grid indicates that the water volume is 0-30%.

The second grid indicates that the water volume is 30% -60%.

The third grid indicates that the water volume is 60% -100%.

US1

High effectiveness osteotomy of large bone sections during maxillofacial surgery, it can also be used for exodontia exodontics.

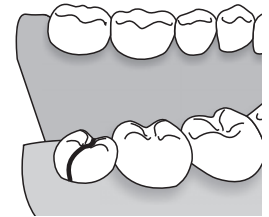
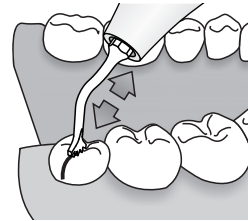
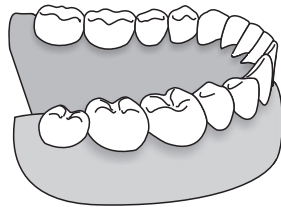
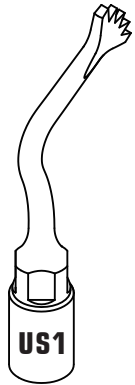

MODE: BONE

POWER: Quality1, Quality2, Quality3
(Cortical/Spongious)

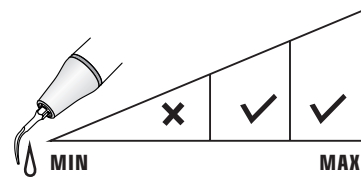

IRRIGATION

US1L

Left angle 90°, horizontal osteotomy technique in maxilla and mandible.

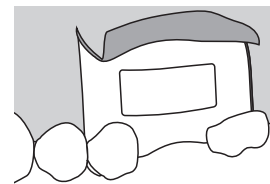
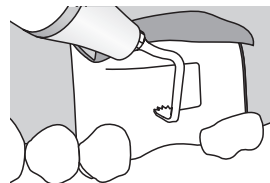
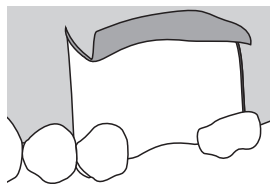
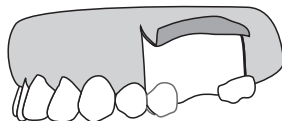

1

2

3

MODE: BONE

POWER: Quality1, Quality2, Quality3
(Cortical/Spongious)

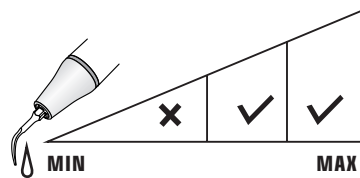

IRRIGATION

US1R

Right angle 90°, horizontal osteotomy technique in maxilla and mandible.

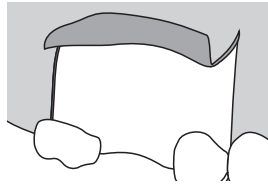
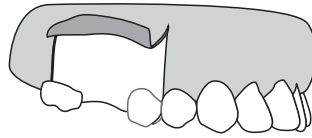
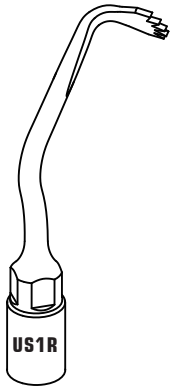

1

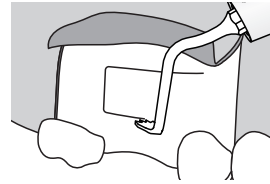

2

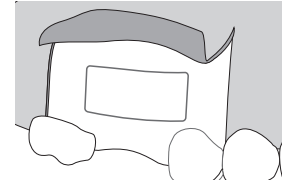

3

MODE: BONE

POWER: Quality1, Quality2, Quality3
(Cortical/Spongius)

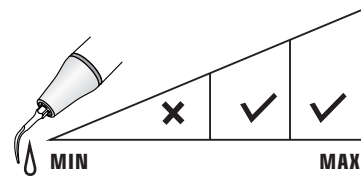

IRRIGATION

US2

High effectiveness osteotomy technique in maxilla and mandible(ridge expansion, corticotomy technique, bone block grafting).

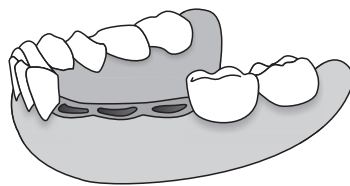
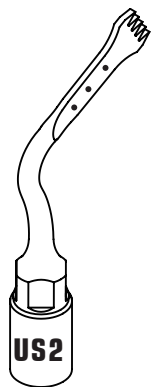

1

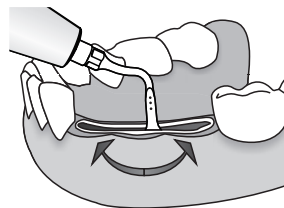

2

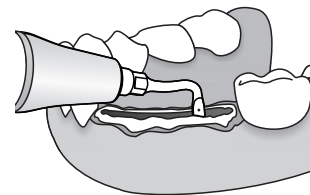

3

MODE: BONE

POWER: Quality1, Quality2, Quality3
(Cortical/Spongiuous)

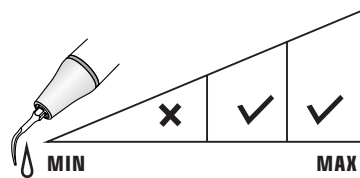

IRRIGATION

US3

Osteotomy: osteotome of great precision in anatomically thin structures.

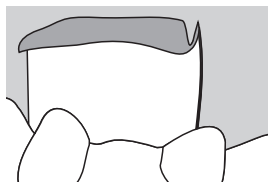
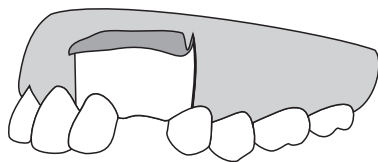
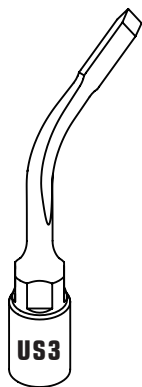

1

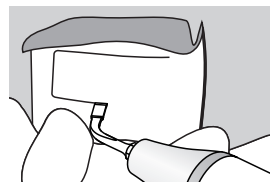

2

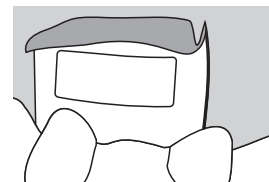

3

MODE: BONE

POWER: Quality1, Quality2, Quality3
(Cortical/Spongious)

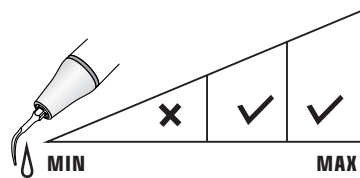

IRRIGATION

US4

Universal osteoplasty: periodontal osteotomy, bone chips harvesting, inflammatory tissue removal (cyst, etc.).

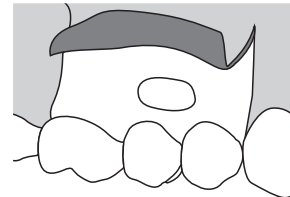
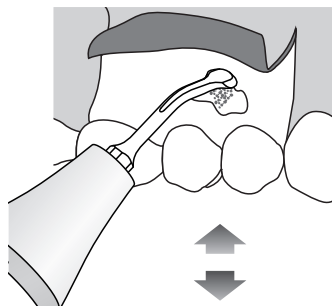
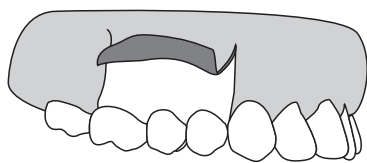
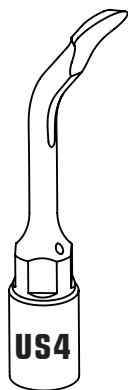

MODE: BONE

POWER: Quality1, Quality2, Quality3
(Cortical/Spongious)

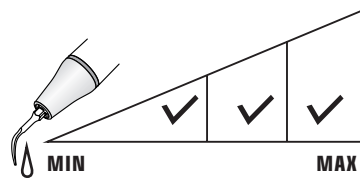

IRRIGATION

US5

High efficiency bone osteoplasty: bone remodelling and harvesting of bone chips.

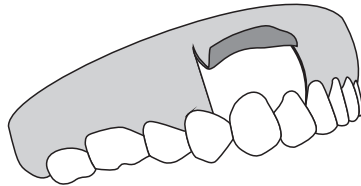
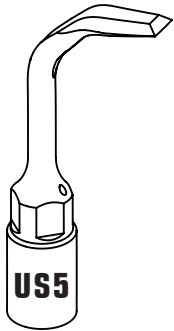

1

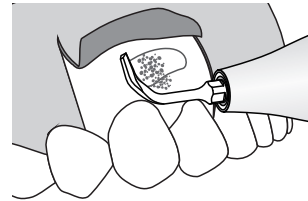

2

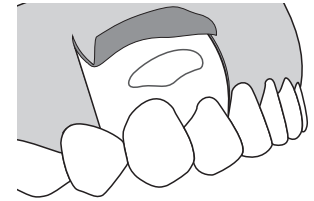

3

MODE: BONE

POWER: Quality1, Quality2, Quality3
(Cortical/Spongious)

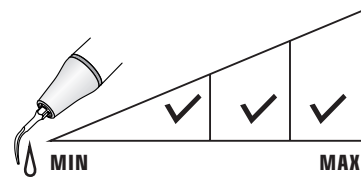

IRRIGATION

US6

Osteotomy: osteotome of great precision in anatomically thin structures (ridge expansion, corticotomy technique).

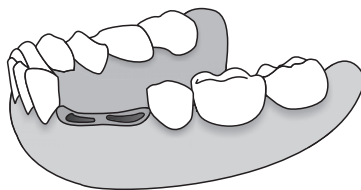
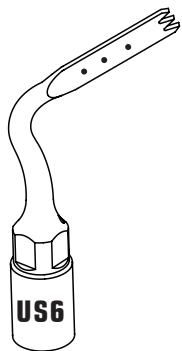

1

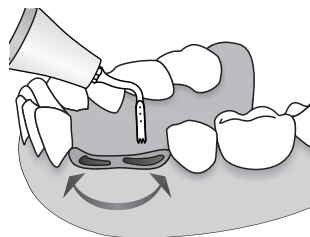

2

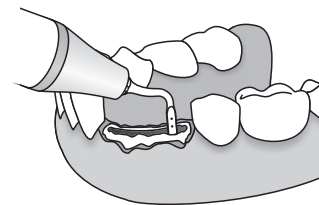

3

MODE: BONE

POWER: Special

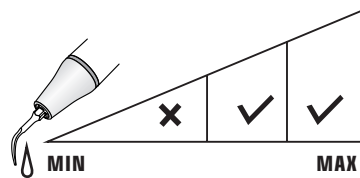

IRRIGATION

US13

For osteotomy and the removal of apex in posterior teeth area.

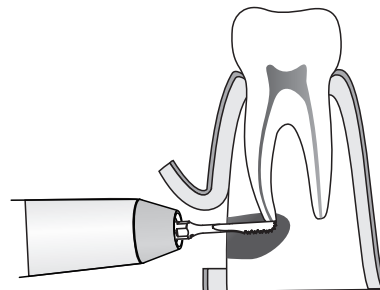
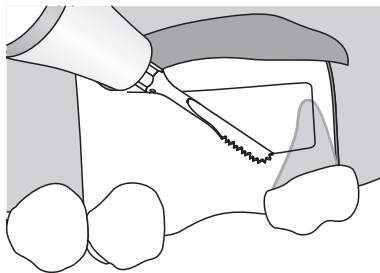

MODE: BONE

POWER: Special

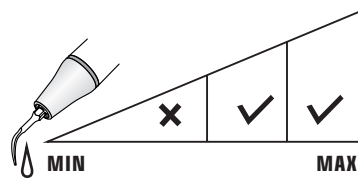

IRRIGATION

US21

Used for bone cutting. Fan-shaped serration, more convenient for cutting in different angle.

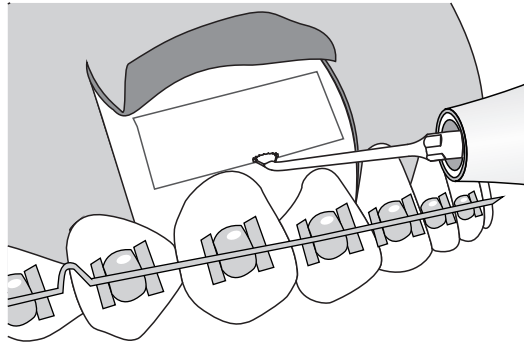
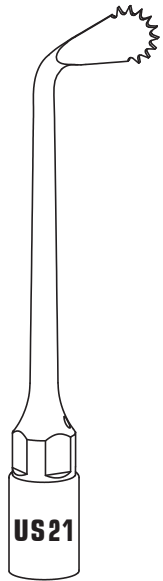

MODE: BONE

POWER: Special

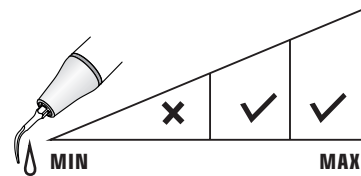

US25

Used for bone surgery.

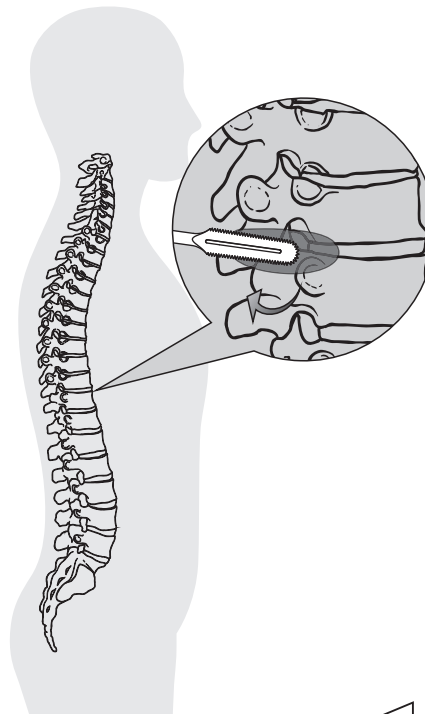
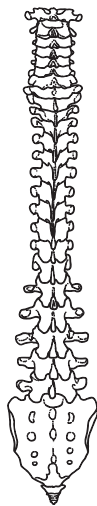

MODE: BONE

POWER: Special

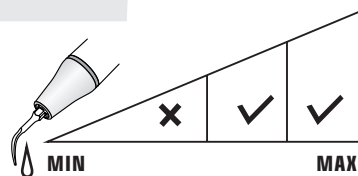

IRRIGATION

UL1

Tip angle 120°, separation of the sinus membrane in internal zones, non-cutting elevator of the sinus membrane.

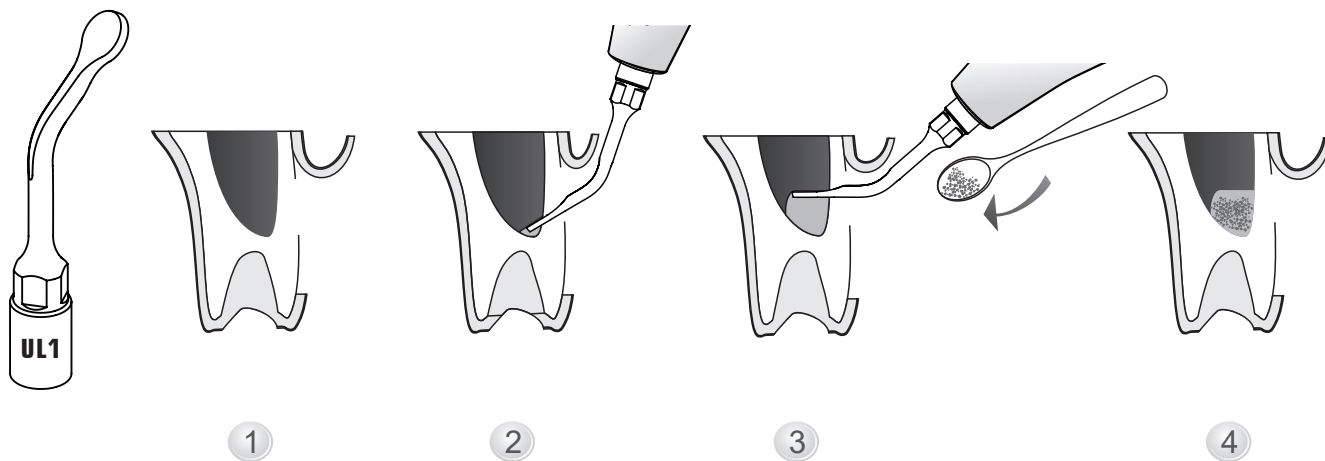

MODE: ROOT

POWER: Endo(Maximum power permitted)

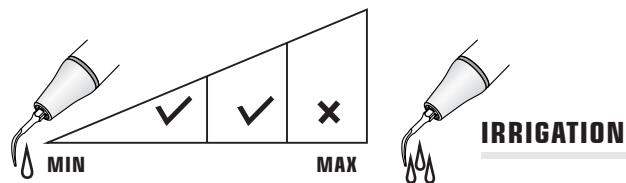

UL2

Schneiderian membrane separation from bony walls: separation of the sinus membrane.

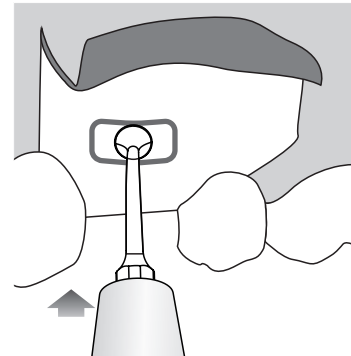
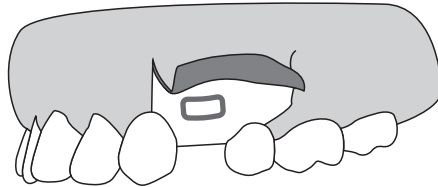
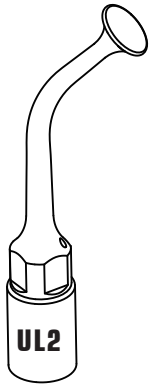

MODE: ROOT

POWER: Endo(Maximum power permitted)

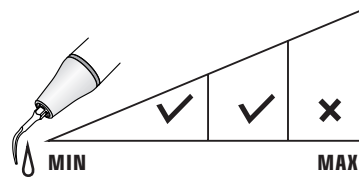

IRRIGATION

UL3

Diamond-coated(100µm) instrument for micrometric osteotomy or osteoplasty; non-traumatic, to finalize the osteotomy or osteoplasty on thin bone and/or near delicate anatomic structures.

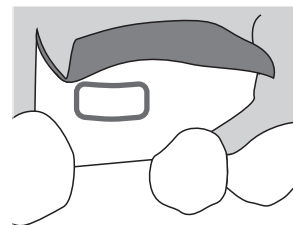
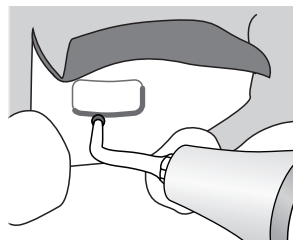
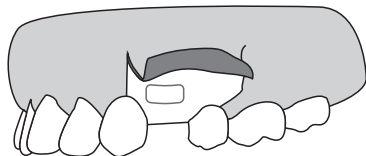
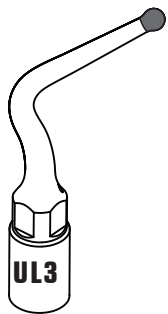

MODE: BONE

POWER: Quality1, Quality2, Quality3
(Cortical/Spongiuous)

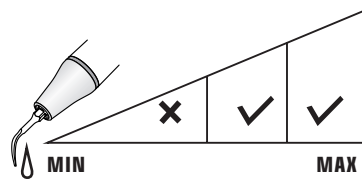

IRRIGATION

UL5

Tip angle 95°, separation of the sinus membrane in internal zones, non-cutting elevator of the sinus membrane.

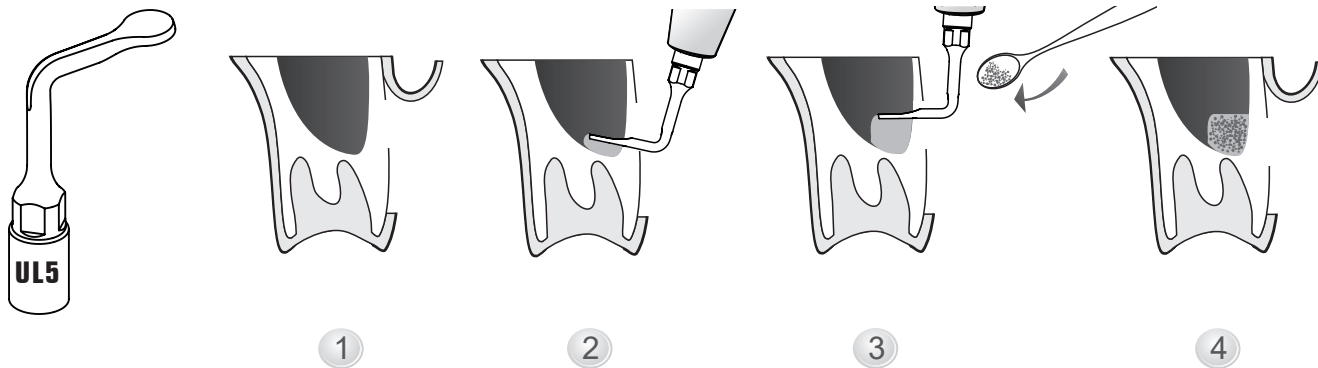

MODE: ROOT

POWER: Endo(Maximum power permitted)

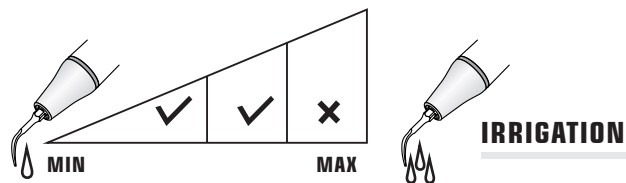

UL4

Diamond-coated(100µm) instrument for micrometric osteotomy: to finalize the osteotomy in proximity of soft tissue (sinus membrane, vessel, alveolar nerve).

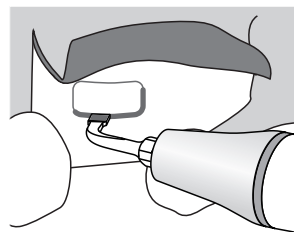
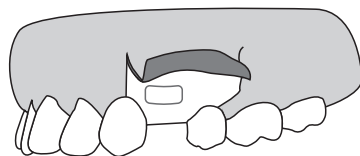
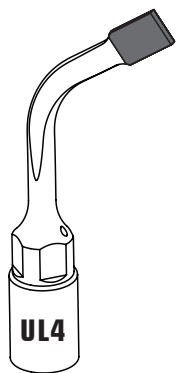

1

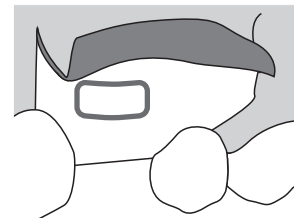

2

MODE: BONE

POWER: Quality1, Quality2, Quality3
(Cortical/Spongious)

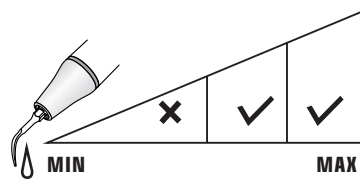

IRRIGATION

UL8

Diamond-coated head (100 μ m), used for non-traumatic osteotomy and osteoplasty near soft tissue and thin bone region.

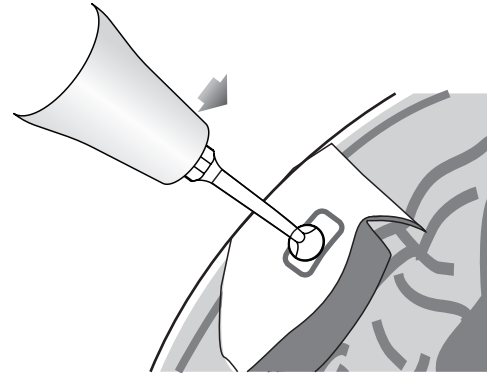
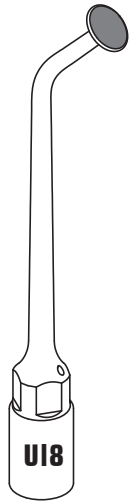

MODE: ROOT

POWER: Endo(Maximum power permitted)

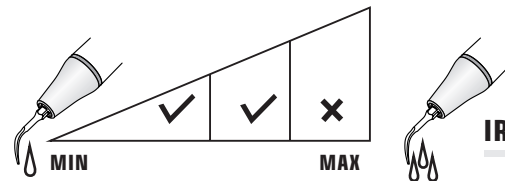

IRRIGATION

UE1

Diamond-coated(40 μ m) instrument for apical root debridement: diamond-coated instrument for efficient root planning. The length of the diamond-coated on tip is (3.3mm).

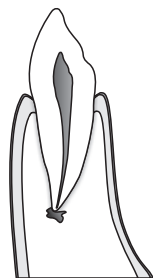
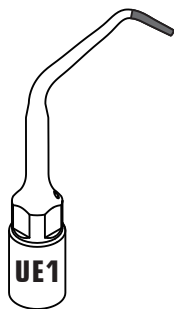

1

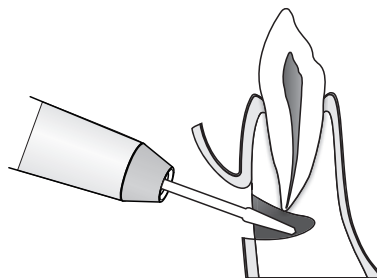

2

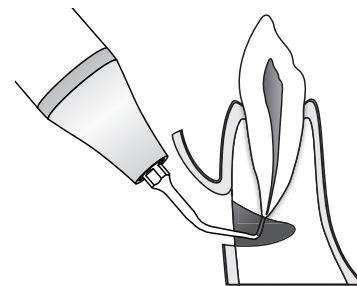

3

MODE: ROOT

POWER: Endo(Maximum power permitted)

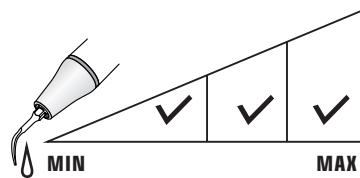

IRRIGATION

UE2

Used for gentle canal cleaning. The length of tip slender smooth part is (4.5mm).

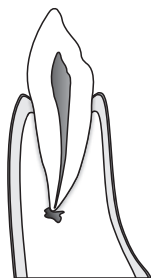
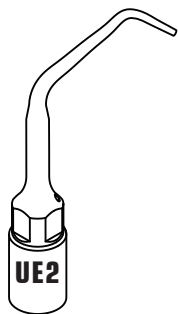

1

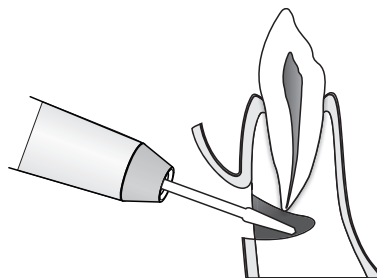

2

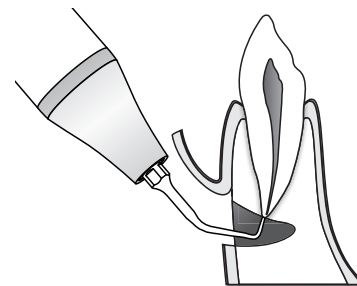

3

MODE: ROOT

POWER: Endo(Maximum power permitted)

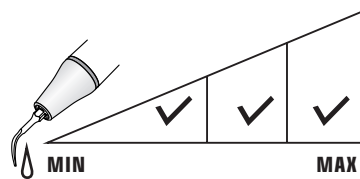

IRRIGATION

UE3

Diamond-coated(40 μ m) instrument for apical root debridement: diamond-coated instrument for efficient root planning. The length of the diamond-coated on tip is (2.2mm).

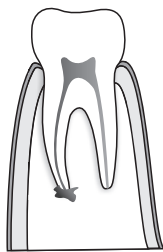
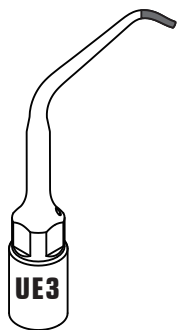

1

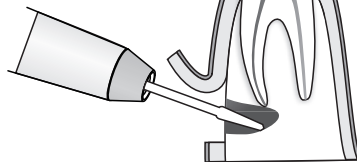

2



3

MODE: ROOT

POWER: Endo(Maximum power permitted)

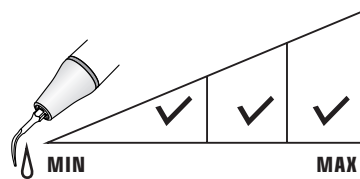

IRRIGATION

UE4

Used for gentle canal cleaning. The length of tip slender smooth part is (3.5mm).

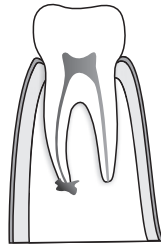
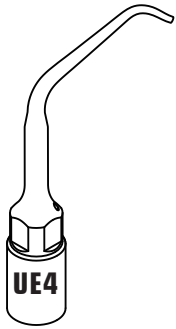

1

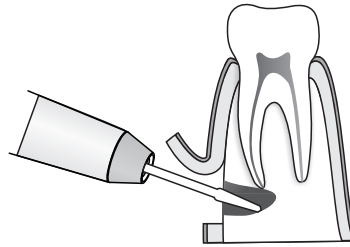

2

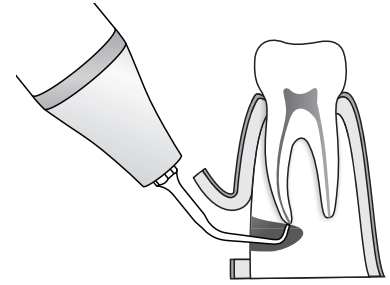

3

MODE: ROOT

POWER: Endo(Maximum power permitted)

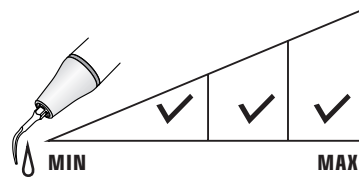

IRRIGATION

UC1

Used to cut off the ankylosis and root fraction techniques.

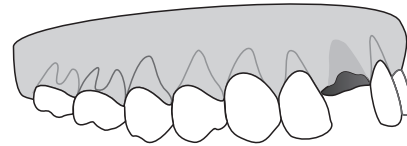
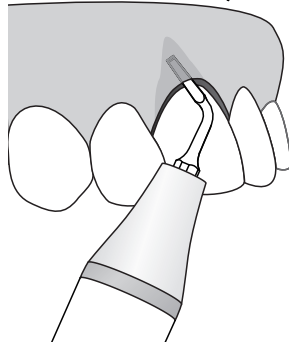
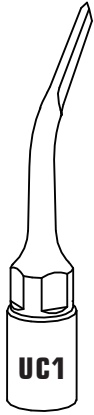

MODE: BONE

POWER: Quality1, Quality2, Quality3
(Cortical/Spongious)

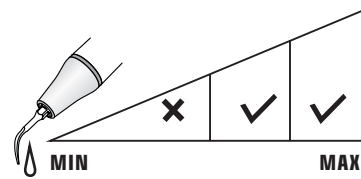

UC2

Left curved, Used to cut off the ankylosis, root fraction techniques in the posterior regions.

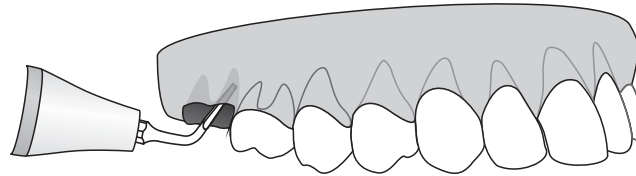

MODE: BONE

POWER: Quality1, Quality2, Quality3
(Cortical/Spongious)

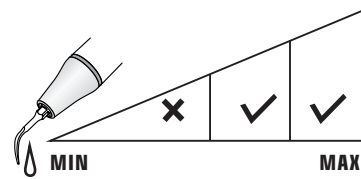

IRRIGATION

UC3

Right curved, Used to cut off the ankylosis, root fraction techniques in the posterior regions.

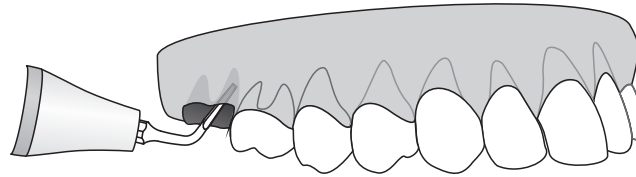

MODE: BONE

POWER: Quality1, Quality2, Quality3
(Cortical/Spongious)

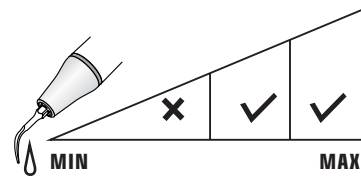

IRRIGATION

UC6

For teeth extraction and alveolar bone splitting

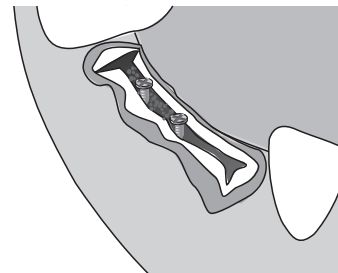
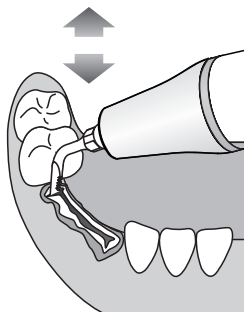
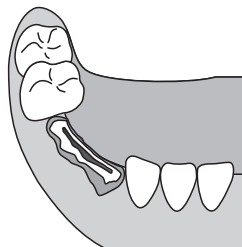
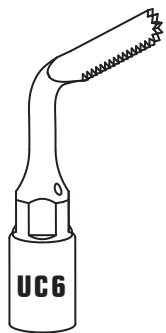

MODE: BONE

POWER: Quality1, Quality2, Quality3
(Cortical/Spongious)

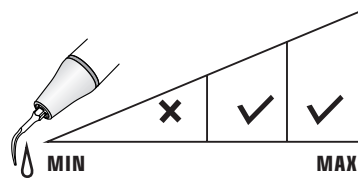

IRRIGATION

UC7

For teeth extraction and alveolar bone splitting

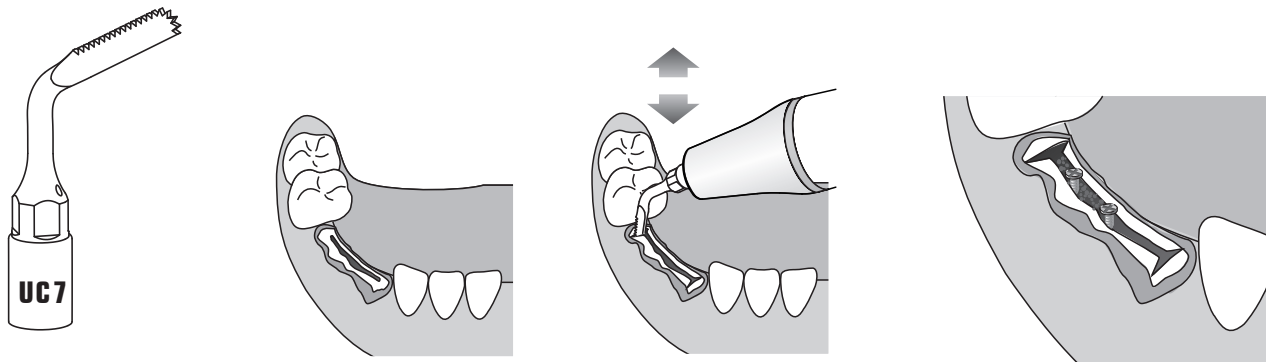

MODE: BONE

POWER: Quality1, Quality2, Quality3
(Cortical/Spongious)

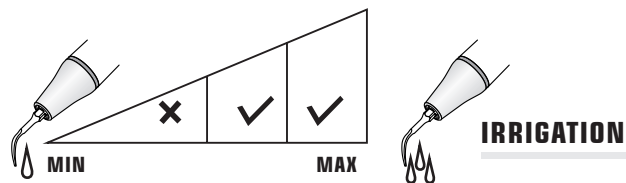

U11

Ø1.6mm implantation site preparation insert. The working length of the tip is (9mm).

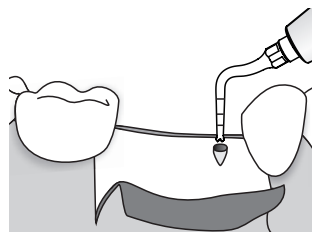
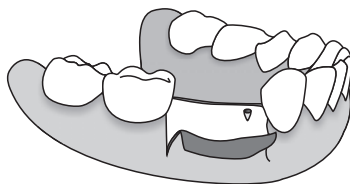
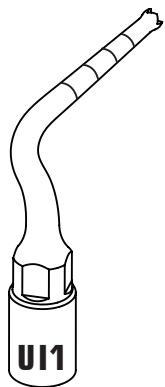

1

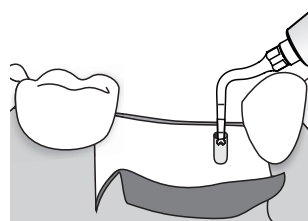

2

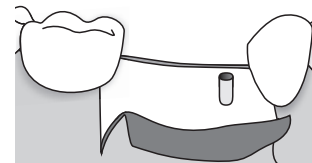

3

MODE: BONE

POWER: Quality1, Quality2, Quality3
(Cortical/Spongious)

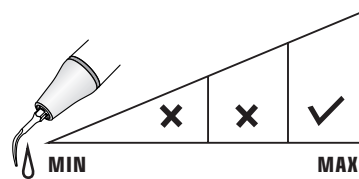

IRRIGATION

U12

Ø2mm implantation site preparation insert. The hole at the center of the top for water spray maximum reduce the heat.

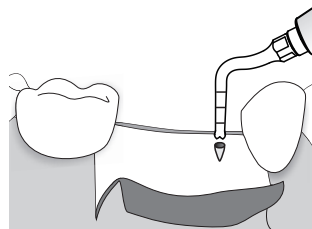
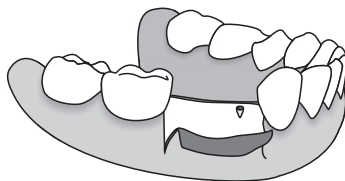
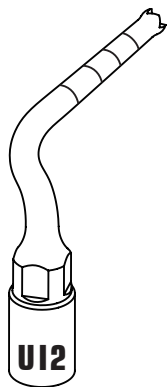

1

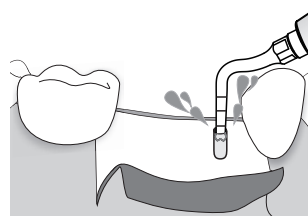

2

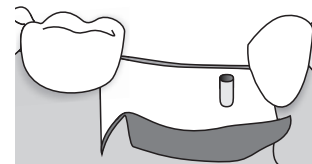

3

MODE: BONE

POWER: Quality1, Quality2, Quality3
(Cortical/Spongious)

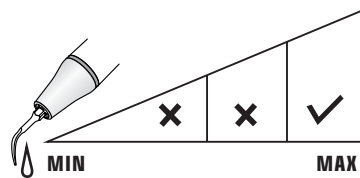

IRRIGATION

U17

Diamond-coated(85µm) instrument for finalizing the implantation site preparation close to the alveolar nerve.

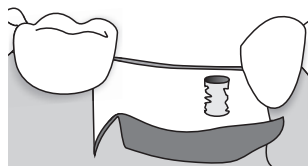
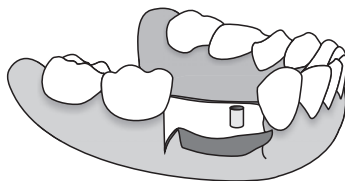
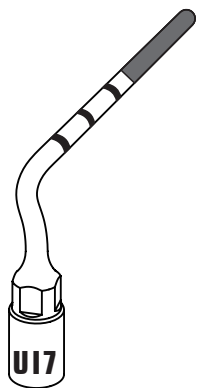

1

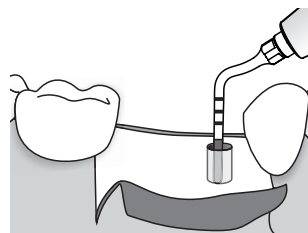

2

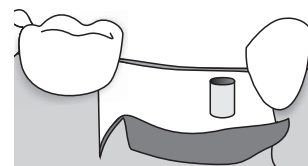

3

MODE: BONE

POWER: Quality1, Quality2, Quality3
(Cortical/Spongious)

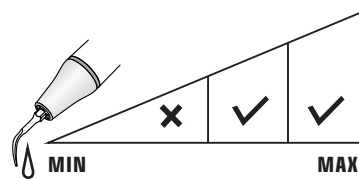

IRRIGATION

U18

Ø1.6mm implantation site preparation insert. The working length of the tip is (15mm).

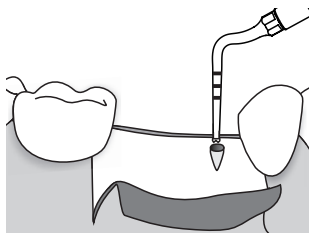
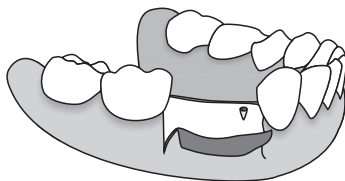
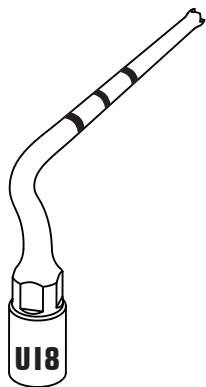

1

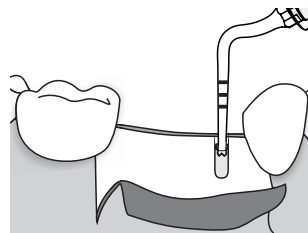

2

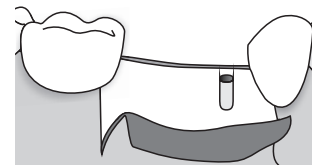

3

MODE: BONE

POWER: Quality1, Quality2, Quality3
(Cortical/Spongius)

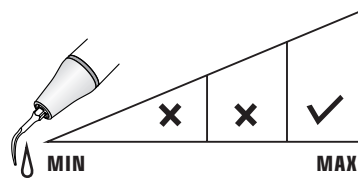

IRRIGATION

U19

Ø2.8mm implantation site preparation insert . The hole at the center of the top for water spray maximum reduce the heat.

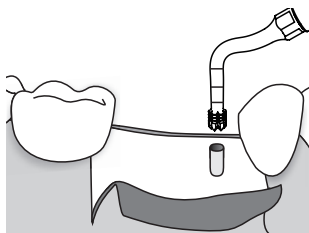
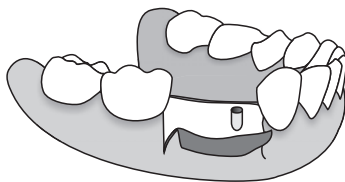
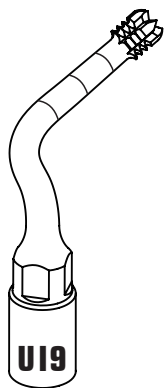

1

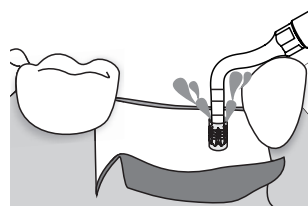

2

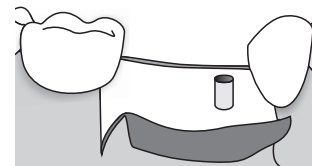

3

MODE: BONE

POWER: Quality1, Quality2, Quality3
(Cortical/Spongius)

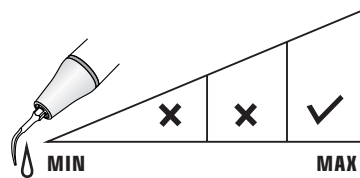

IRRIGATION

UP1

Recommended for periodontal gentle curetting scaling.

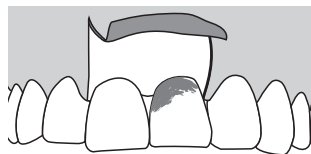
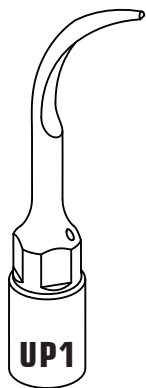

1

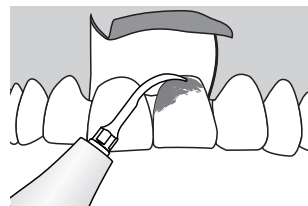

2

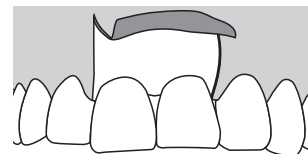

3

MODE: ROOT

POWER: PERIO

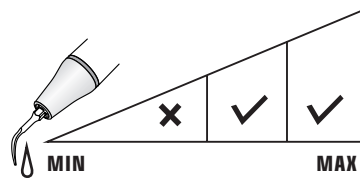

IRRIGATION

UP2

Inflammatory tissue removal and fractured root apex extraction.

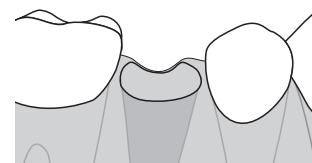
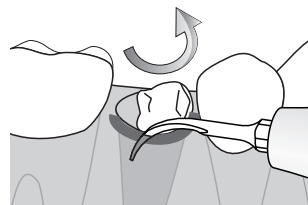
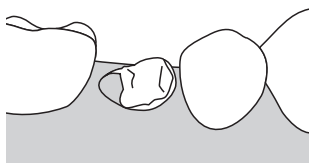
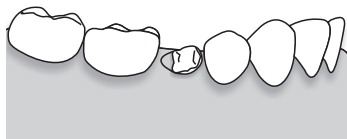
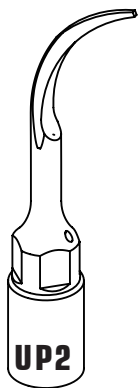

MODE: ROOT

POWER: PERIO

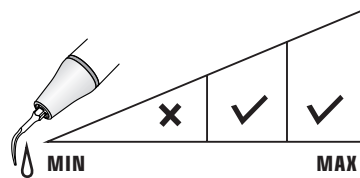

IRRIGATION

UP3

Recommended for angled periodontal gentle curetting scaling.

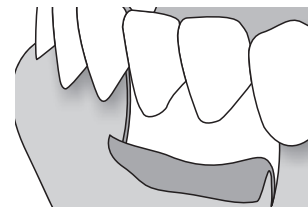
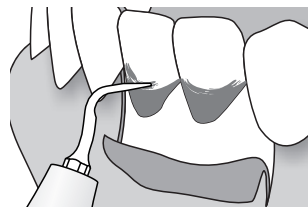
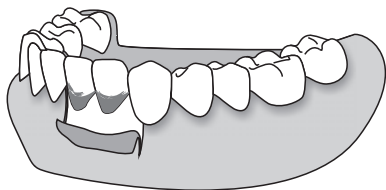
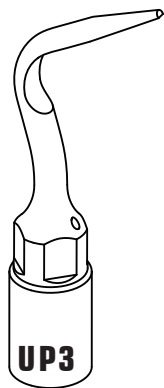

MODE: ROOT

POWER: PERIO

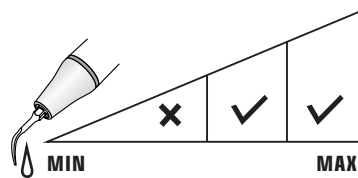

IRRIGATION

UP4

Diamond-coated(40µm) instrument for root debridement and root planning.

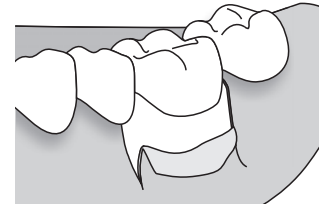
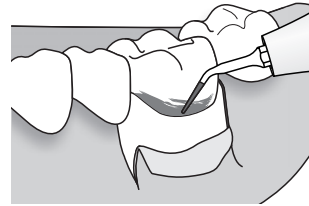
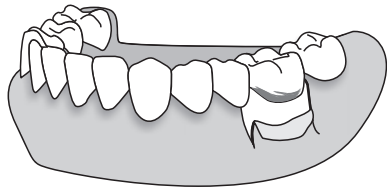
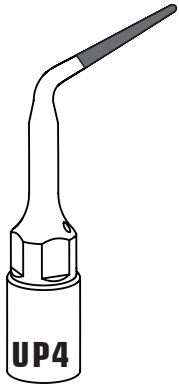

MODE: ROOT

POWER: PERIO

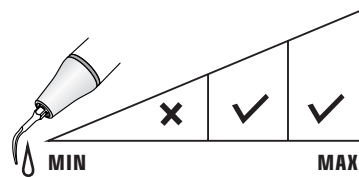

IRRIGATION

UP5

Recommended for root surface micro-smoothing.

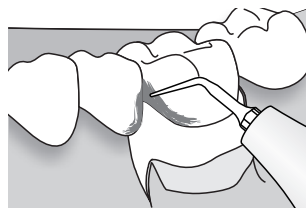
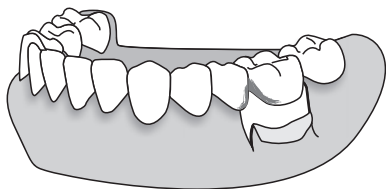
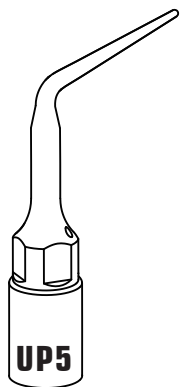

1

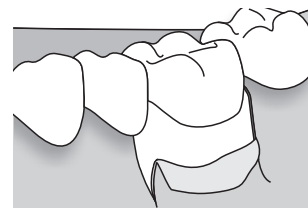

2

MODE: ROOT

POWER: PERIO

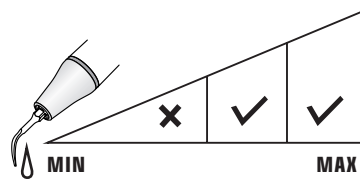

IRRIGATION

UP6

Diamond-coated(40µm) instrument for micro-osteoplasty: interproximal osteoplasty and root planning.

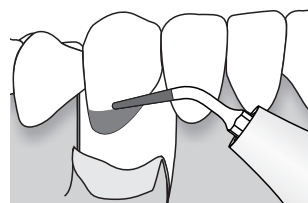
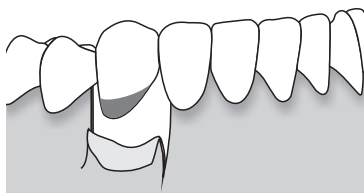
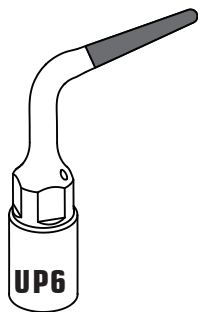

1

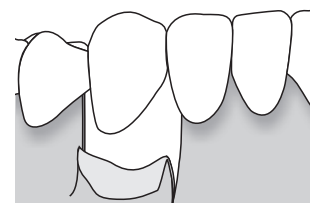

2

MODE: ROOT

POWER: Quality1,Quality2,Quality3
(Cortical/Spongious)

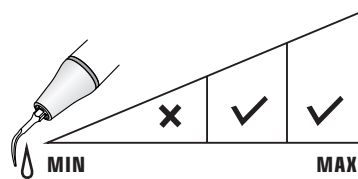

IRRIGATION

UP7

Diamond-coated(40 μ m) instrument for root canal orientation and removal of the calcifications located at the 1/3 part of root canal, it can also be used for micro-osteoplasty.

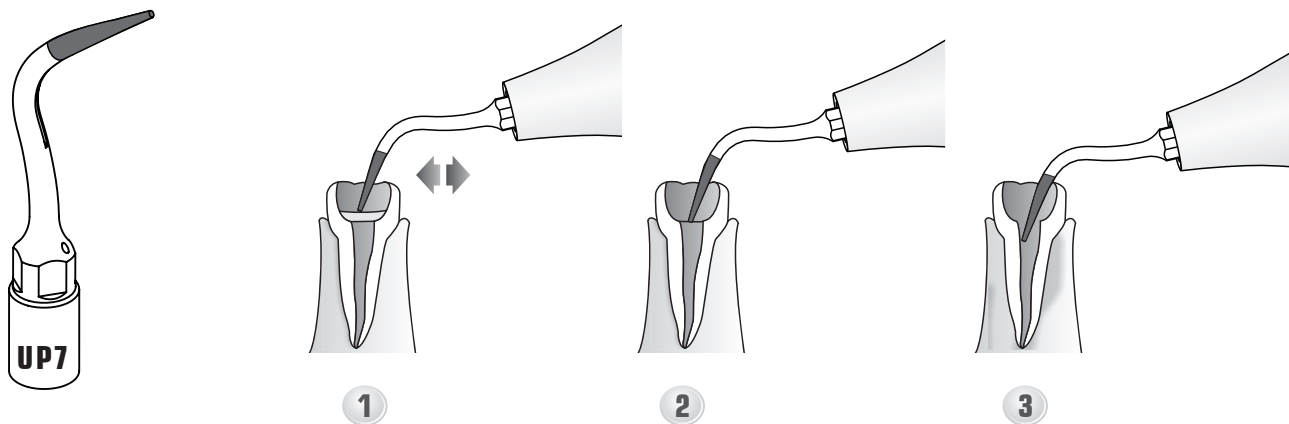

MODE: ROOT

POWER: Endo(Maximum power permitted)

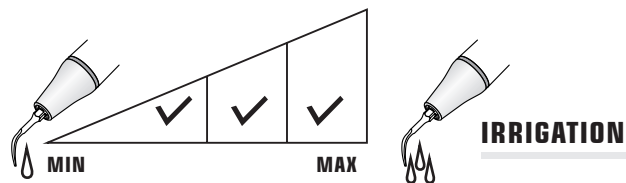

Attached list: Other tips

	Tip Model	Compatible Brand
Scaling	GS1/GS2/GS3/GS4/GS5/GS6/GS7/GS8	Compatible with Sirona Scalers
Periodontics	PS1/PS3/PS3D/PS4	
Endodontics	ES1/ES2/ES3/ES3D/ES4/ES4D/ES5/ES5D/ PS4D/ES8/ES10/ES10D/ES11/ES11D/ES14 /ES15	
Scaling	GK1/GK2/GK3/GK4/GK5/GK6/GK7/GK11/ GK20/GK21/GK60/GK61/GK62	Compatible with Kavo Scalers
Endodontics	EK8	
Scaling	GC1/GC2	
Periodontics	PC1/PC61/PC61/PC62	
Scaling	A1/A2	Compatible with Amdent Scalers

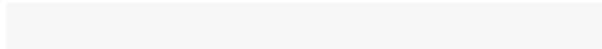



www.glwoodpecker.com



Guilin Woodpecker Medical Instrument Co., Ltd.
Information Industrial Park, Guilin National High-Tech
Zone, Guilin, Guangxi, 541004 P. R. China

Tel:

Europe Sales Dept.: +86-773-5873196

North/South America & Oceania Sales Dep.:+86-773-5873198

Asia & Africa Sales Dep.:+86-773-5855350 Fax: +86-773-5822450

E-mail: woodpecker@glwoodpecker.com, sales@glwoodpecker.com

Website: <http://www.glwoodpecker.com>



MedNet GmbH
Borkstrasse 10 · 48163 Muenster · Germany

