

# User Manual



## Newtron Booster



This document is an English translation of the original French version.  
Reference J60110 version V8 and drawing number NBABFR030H

# Contents

---

<b>1 Documentation</b>	<b>5</b>
1.1 Associated documentation	5
1.2 Electronic documentation	5
<b>2 Required information</b>	<b>7</b>
2.1 Indication for use	7
2.2 Operating principle	7
2.3 Using accessories not supplied by the manufacturer	7
2.4 Connecting and disconnecting accessories during use	7
2.5 Repairing or modifying the medical device	7
2.6 Warranty	8
2.7 Latest document update	8
2.8 Date of first CE marking	8
<b>3 Unpacking the medical device</b>	<b>9</b>
<b>4 Connect the medical device</b>	<b>11</b>
4.1 Connecting the medical device to the water system	11
4.2 Connecting the medical device to the water system	11
4.3 Installing a water filter	11
4.4 Connecting the medical device to the electrical network	11
4.5 Connecting the medical device to the electrical network	11
<b>5 Installing the medical device</b>	<b>13</b>
5.1 Fixing the medical device to a non-removable support	13
5.2 Install cords	13
5.3 Installing the control pedal	13
5.4 Connecting the ultrasonic	13
5.5 Attaching a tip or a file	13
<b>6 Dispensing a treatment</b>	<b>15</b>
6.1 Accessory usage conditions	15
6.2 Preparation for use	15
<b>7 Medical device description</b>	<b>17</b>
7.1 Control unit	17
7.2 Light indicator	17
7.3 Handpiece	17
7.3.1 Handpiece cord	17
7.4 Adjusts the power	17
7.5 Setting the irrigation flow	17
7.6 Air inlets	17
7.7 Control pedal	17
7.8 Mains adapter	18
<b>8 Disinfection and sterilising</b>	<b>19</b>
8.1 Clean and disinfect the medical device	19
8.2 Cleaning, disinfecting and sterilising accessories	19
<b>9 Monitoring and routine maintenance</b>	<b>21</b>
9.1 Cleaning the irrigation system	21
9.2 Clean the water filter cartridge.	21
<b>10 Identifying incorrect operation</b>	<b>23</b>
10.1 Not working	23
10.2 No spray	23
10.3 The power is not as expected	23
10.4 Ultrasounds not working	24
10.5 Water leakage	24
<b>11 Technical specifications of the medical device</b>	<b>25</b>

---

11.1 Identification .....	25
11.2 Mains Adapter .....	25
11.3 Generator .....	25
11.4 Length of cords .....	25
11.5 Irrigation .....	26
11.6 Footswitch .....	26
11.7 Environmental characteristics .....	26
11.8 Environmental restrictions .....	26
11.9 Main performance characteristics .....	26
<b>12 Regulations and standards .....</b>	<b>27</b>
12.1 Applicable standards and regulations .....	27
12.2 Medical class of the device .....	27
12.3 Symbols .....	27
12.4 Manufacturer identification .....	30
12.5 Branch addresses .....	31
12.6 Disposal and recycling .....	32
<b>13 Index .....</b>	<b>34</b>

# Foreword

The medical device that you are about to install and use in your practice is a medical device designed for professional use. It is therefore a key tool with which you will provide treatment within the context of your work.

To ensure optimum safety for yourself and your patients, comfort in your daily practice and to benefit fully from the technology of your medical device, please read the documentation provided carefully.

Please refer to the cleaning, disinfection and sterilisation instructions for accessories and to the cleaning, disinfection and sterilisation instructions for handpieces for information about the following:

- Preparation of parts for sterilisation
- Detailed manual and automated instructions
- Information concerning conditioning for sterilisation
- Recommendations for the inspection of parts

Please refer to the instructions for the entire range of SATELEC, a company of Acteon group dental ultrasonic generators for information about the following:

- Documentation format
- Documentation archiving period
- Warnings concerning user and patient populations
- Treatment area
- Medical device usage interactions, contraindications and prohibitions
- Disposal and recycling of the medical device
- Manufacturer responsibility

Please refer to the User Manuals, Quick Start Guides and Quick Clean Guides for each medical device for information about the following:

- Unpacking and installing the medical device
- Using the medical device
- Monitoring and maintaining the medical device
- Technical specifications of the medical device



# 1 Documentation

This document contains the following information:

- Indications for use
- Medical device description
- Installation of the medical device
- Medical device use
- Preparation for cleaning and disinfection of the medical device
- Monitoring and general maintenance of the medical device
- Maintenance to be performed by the user

## 1.1 Associated documentation

This document must be used in association with the following documents:

Document title	References
General instructions relating to the complete range of dental ultrasonic generators	J00011
Cleaning, disinfection and sterilisation instructions for wrenches	J81001
Cleaning, disinfection and sterilisation instructions for tips	J02001
Cleaning, disinfection and sterilisation instructions for handpieces	J12911
Ultrasonic generator power settings table	J58000
Consulting electronic user instructions	J00007
Newtron® Booster User Manual	J60111
Quick Clean Newtron® Booster	J60101
Quick Start Newtron® Booster	J60100
Newtron handpiece user manual	J12641
Air and water filter and cartridge replacement and installation instructions	J11330

The Quick Start and Quick Clean documents are summaries created for your approval. The only binding instructions are the user manuals and regulatory documentation associated with the medical device.

## 1.2 Electronic documentation



The user instructions for your device are available in electronic format on the specified website and not in printed format. If the website is unavailable, try again later. You can also request a free printed copy of the user instructions within seven days via our website, by telephone or in writing.

The electronic user instructions are available in PDF format (Portable Document Format). You will need to have a PDF file reader installed to read the electronic user instructions. It is important for you to have read and understood the content of the user instructions relating to the use of your device and its accessories.

Never use your device without first reading the user instructions.

The device user instructions can be consulted at the following addresses: [www.ultradent.com](http://www.ultradent.com) and [www.satelec.com](http://www.satelec.com).

When you receive your device, you are asked to print and/or to download all documents or sections of documents that you may need to refer to in the event of an emergency, if you are unable to connect to the internet or if your electronic display tool is not working (computer, tablet, etc.). We recommend that you visit the website regularly to consult and to download the latest version of your device's user instructions. Users are asked to keep documentation close at hand for reference when necessary.

All paper or electronic documentation relating to your medical device must be kept for the device's entire service life.

Keep the original documentation for your medical device and its accessories for future reference. When loaning out or selling the medical device, the documentation must be provided with it.



## 2 Required information

### 2.1 Indication for use

This medical device is used with a dental ultrasonic handpiece to which an ultrasonic instrument is attached. It is designed for the treatment of prophylaxis, periodontics, endodontics and preservation and restoration dentistry.

### 2.2 Operating principle

An electrical signal emitted by the medical device is supplied to the ultrasonic handpiece. This is connected to the medical device via a cord. The handpiece comprises a piezoelectric ceramic transducer, which transforms the electrical signal into ultrasonic vibrations.

Mechanical vibrations are transmitted to a tip or a dental file attached to the end of the ultrasonic handpiece.

### 2.3 Using accessories not supplied by the manufacturer

The handpiece is designed to operate with SATELEC, a company of Acteon group dental tips and files. The use of tips or files made by other manufacturers will damage the handpiece, break tips and files and void the warranty.

### 2.4 Connecting and disconnecting accessories during use

Do not tighten or loosen the tips when the handpiece is activated.

### 2.5 Repairing or modifying the medical device

Contact the supplier of your device. Using the services of an unapproved repairer could render your device dangerous for you and your patients.

Do not repair or modify the device without seeking the prior permission of SATELEC, a company of Acteon group.

If the device is modified or repaired, specific checks and tests must be carried out to ensure that the medical device is still safe to use.

In the event of doubt, contact an approved dealer or the SATELEC, a company of Acteon group Customer Service team:

[www.acteongroup.com](http://www.acteongroup.com)

[satelec@acteongroup.com](mailto:satelec@acteongroup.com)

SATELEC, a company of Acteon group, at the request of technical personnel working for the network of approved dealers, will provide any information required to repair defective parts on which they may perform repairs.

## 2.6 Warranty

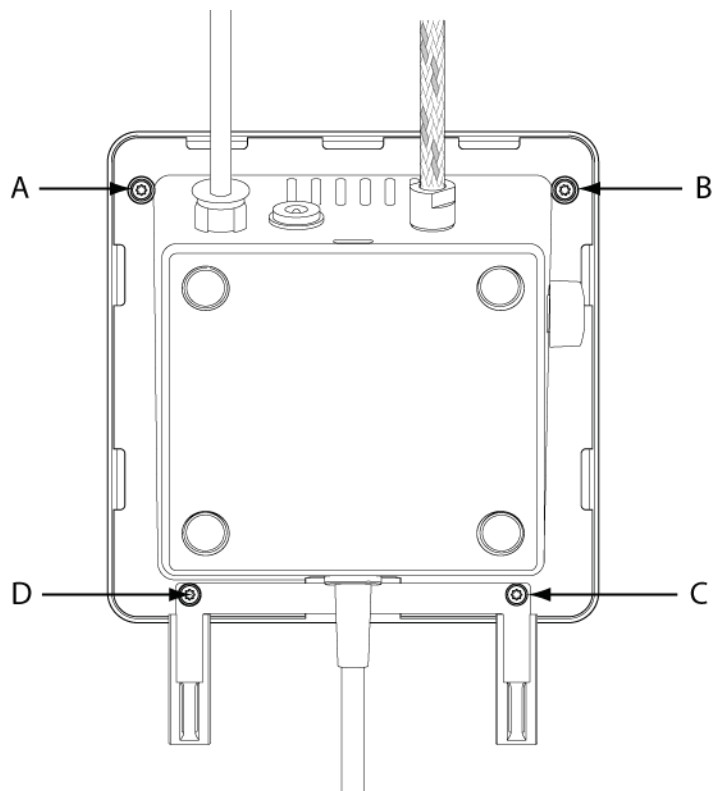

The screws marked A, B, C and D must not be unscrewed by the user under any circumstances as this may void the warranty for the medical device.

## 2.7 Latest document update

09/2017

## 2.8 Date of first CE marking

2013

### 3 Unpacking the medical device

When you receive your medical device, check for any damage that may have occurred during transportation.

If you have received this medical device by mistake, please contact the supplier to arrange for it to be collected.

If you have any questions or requirements, contact your supplier.

The Newtron® Booster includes the following items:

- A Newtron® Booster unit with non-detachable footswitch cord, a non-detachable handpiece cord, a handpiece support.
- A disconnectable water supply pipe
- A Newtron handpiece
- A Newtron® Booster [J60100] Quick Start guide
- A Newtron® Booster [J60101] Quick Clean guide
- An attachment kit
- Tips and wrenches depending on selected options
- A mains adapter and its cord



## 4 Connect the medical device

### 4.1 Connecting the medical device to the water system

| Ask an approved dental installation technician to connect your medical device to the water system.

The water supply system pressure may vary throughout the day. The water supply system pressure must be adapted to the values recommended for your medical device. It is very important to make sure that the maximum pressure permitted for the medical device is never reached or exceeded. If in doubt, you are strongly advised to install or arrange for installation of a water pressure limiting system.

Before a long period of absence or when the medical device is not in use for a long period of time, turn off the water supply to the device or dental practice.

### 4.2 Connecting the medical device to the water system

The supply pipe connector is used to connect the medical device to the domestic water distribution system. The connector is extended by a pipe to which you must attach a filter. The filter needs to be cleaned and replaced regularly as specified in the chapter *Clean the water filter cartridge. page 21.*

| The water supply must comply with the quality criteria compatible with the practice of dental treatments.

### 4.3 Installing a water filter

Water supplied by the system in place may not be of a quality suitable for dental treatments. In this case, you must install a water filter on the medical device's water supply pipe.

Procure the relevant kit and the installation and maintenance instructions for water and air filters and cartridges [J11330].

| SATELEC, a company of Acteon group accepts no responsibility for damage caused by an installation provided by a service provider that has not been approved by us.

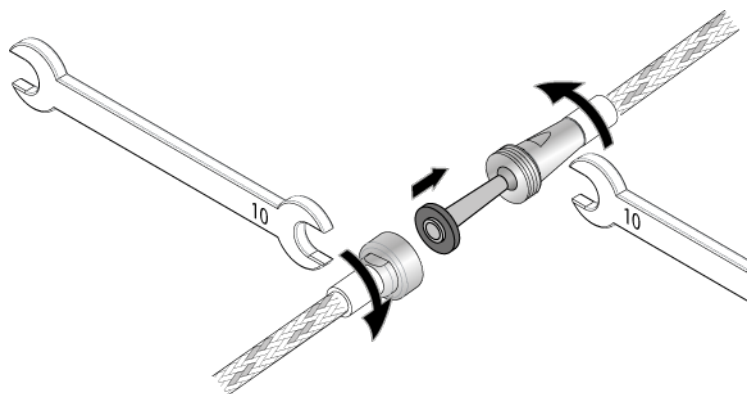

### 4.4 Connecting the medical device to the electrical network

| Have your medical device connected to the mains power by an approved dental installation technician.

A different voltage would cause damage to the medical device and could injure the patient and the user. Any variation in the electrical network voltage or electromagnetic field that is non-compliant with the limits in force, could interfere with the medical device's operation.

Medical devices equipped with a protective earth must be connected to a supply network equipped with a protective earth.

| Do not plug the medical device into an extension lead and do not put the mains cord in a cable cover or cable tray.

### 4.5 Connecting the medical device to the electrical network

1. Move the power configuration button to position O.
2. Connect the mains adapter to the medical device connector.

3. Connect the mains adapter cord to the mains adapter.
4. Connect the mains adapter cord to the electrical fixture wall socket.

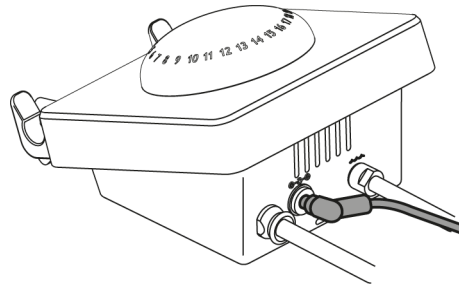

# 5 Installing the medical device

Place the medical device in the position that is suitable for your activity.

The medical device must be placed on a secure and flat surface or a surface with a maximum slope of five degrees.

Check that the cords do not hinder the movement or free circulation of anyone.

Adjust the position of your medical device to correspond to your angle of vision and the characteristics of your workstation, e.g. lighting or distance between the user and the medical device.

Ensure that your medical device is readily accessible. The disconnecting devices - the switch and the power plug - must be easy to access.

Do not install your medical device near or on another device.

## 5.1 Fixing the medical device to a non-removable support

After its initial installation, the medical device is not designed to be moved. The medical device must be fixed to ensure that it cannot be removed or moved without the use of a tool.

## 5.2 Install cords

Never rotate the handpiece connector on its cord as this can damage your medical device.

Never wrap the handpiece cord around the medical device.

Make sure that it is not possible to wheel over or walk on the different cords.

The cord attached to its handpiece must be easily accessible. Make sure that the cord is slack during use.

## 5.3 Installing the control pedal

The control pedal must be positioned near the feet of the operator and must be readily accessible.

## 5.4 Connecting the ultrasonic

Check for any traces of humidity on the handpiece connections. If the connections are damp, dry them with the multi-purpose syringe.

Lubricate the irrigation circuit seal located on the metal shaft on the back of the handpiece with silicone paste. This will prolong its service life and prevent leaks. Do not use spray lubricant on dental instruments.

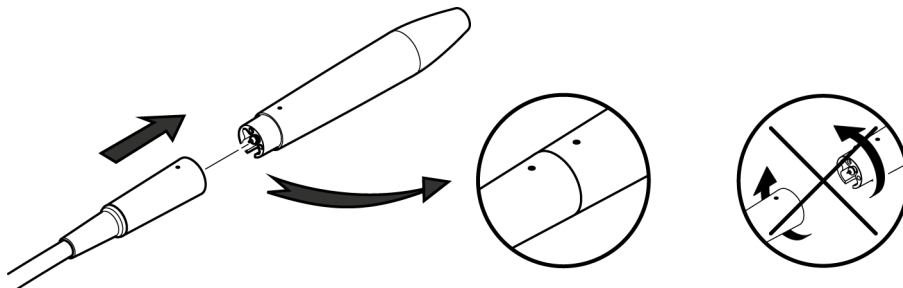

Connect the handpiece to the socket, without rotating it.

## 5.5 Attaching a tip or a file

A tip or a file vibrates correctly when it is perfectly tightened without being forced beyond its stop point. Tighten the tip with the torque wrench (F81320, F81321, F81322 or F81323) to ensure optimum ultrasonic function. Over-tightening of the tip or file with the open-ended wrench can result in breakage of the tip, file or handpiece.

To prevent self-locking of the tip or the file, the latter must be removed and sterilised after each use.

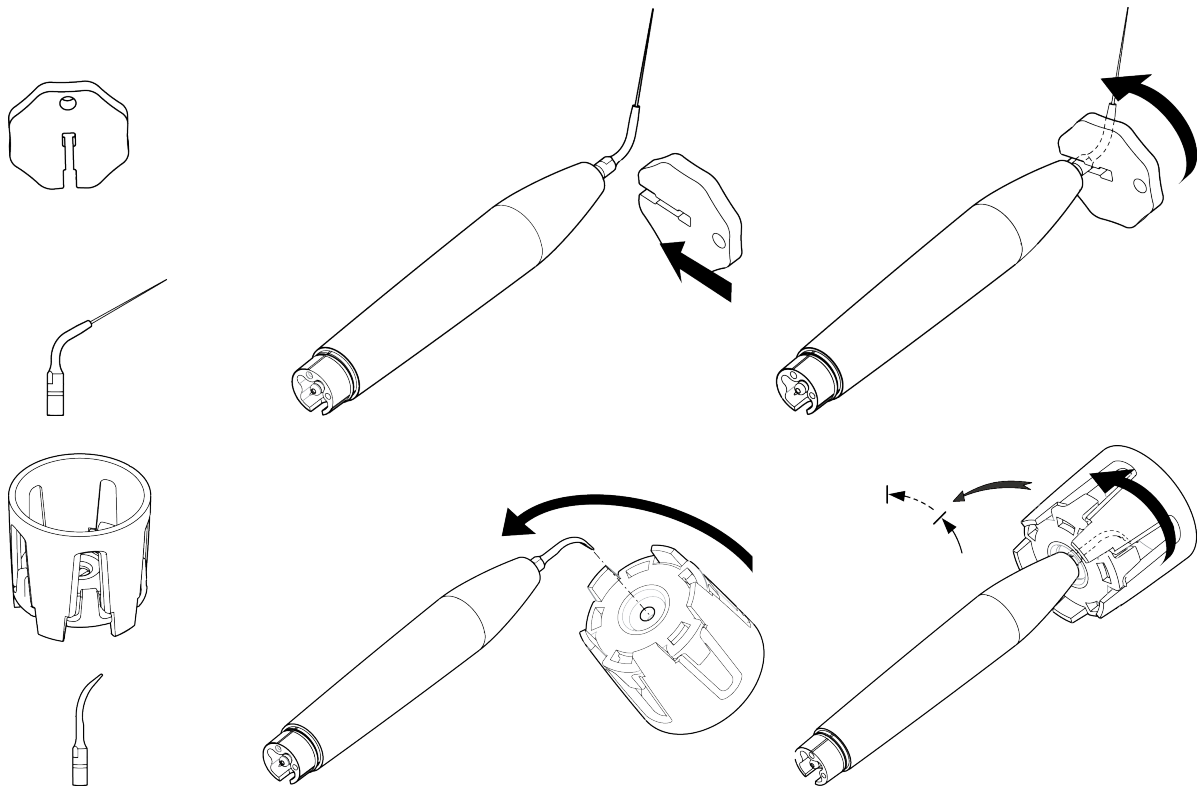

| The torque wrenches must be replaced every year.



# 6 Dispensing a treatment

## 6.1 Accessory usage conditions

The accessories and the handpiece must be cleaned, disinfected and sterilised prior to each use.



Refer to the cleaning, disinfection and sterilisation instructions for accessories listed in the chapter *Associated documentation page 5*.

## 6.2 Preparation for use



Protection  
Glasses Needed

To prepare your medical device, follow the steps below:

1. Wear safety goggles and protective gloves.
2. Clean the unit with an alcohol disinfectant wipe.
3. Remove the handpiece from its sterilisation bag.
4. Remove the wrench from its sterilisation bag.
5. Remove the tip from its sterilisation bag.
6. Screw the tip onto the handpiece, first manually and finishing with the wrench.
7. Connect the handpiece to the handpiece cord socket.
8. Place the handpiece on its support. .
9. Switch on the medical device.
10. Check the irrigation parameters depending on the tip chosen.
11. After water drainage, check that the spray works correctly.

Your medical device is now ready to use.



# 7 Medical device description

## 7.1 Control unit

The control unit incorporates Newtron® technology patented by SATELEC, a company of Acteon group . Newtron® technology emits ultrasonic vibrations in a controlled way. Relayed by SATELEC, a company of Acteon group tips, these vibrations are used to deliver effective treatments and to ensure patient safety. The control unit incorporates an dental ultrasonic generator equipped with a piezoelectric command.

## 7.2 Light indicator

The light indicator is designed to provide information about the status of the medical device. When the light indicator is illuminated, the medical device is on and ready to use.

## 7.3 Handpiece

The medical device must be used with a Newtron handpiece. Refer to the Newtron handpiece user manual [J12641] for more information.

### 7.3.1 Handpiece cord

The cord ensures irrigation circulation and electrical connection between the medical device and the handpiece.

## 7.4 Adjusts the power

The ultrasound power must be adjusted in accordance with the tip used and the required treatment. The operating power of the tips must be selected in compliance with the Acteon tips color coding system (CCS tips). Each tip must be used in accordance with the settings defined in the ultrasonic generator irrigation and power settings table [J58000].

The ultrasound power configuration button ensures:

- Switching On/Switching off of the device (OI symbol).
- Configuration of the operating power: 1 to 20.

The configuration button has four colour sectors, each with five positions.

- Green: 1 to 6: very low to low power, used mainly for periodontics.
- Yellow: 6 to 11: medium power, used mainly for endodontics.
- Blue: 11 to 16: high power, used mainly for scaling and preservation and restoration dentistry.
- Orange: 16 to 20: very high power, used mainly for loosening.

The ultrasound power configuration button is not designed to be removed.

## 7.5 Setting the irrigation flow

The medical device must be set to minimum power to adjust the irrigation flow rate. Press the footswitch until a spray appears.

Because work habits, feedback and professional training differ from one professional to another, the user must ensure that the irrigation flow is compatible with the procedure to be carried out to prevent burns to the clinical site.

Adjust the irrigation flow using the irrigation flow configuration button. The flow rate must be adapted to the tip used and to the required treatment.

Tighten to decrease the flow rate and loosen to increase the flow rate.

The irrigation flow configuration button is not designed to be removed.

To avoid losing any device components, do not loosen the configuration button fully so that it comes off.

Each tip must be used in accordance with the settings defined in the ultrasonic generator irrigation and power settings table [J58000].

## 7.6 Air inlets

Air inlets ensure correct ventilation of the control unit. Leave them uncovered to allow air to circulate.

## 7.7 Control pedal

The ON/OFF type control pedal is used by the practitioner to operate the medical device.

Pressing the footswitch automatically activates the handpiece ultrasounds, and the irrigation function if it is not deactivated.

The footswitch equipped with its cord cannot be disconnected. Its weight and antislip pad ensure good stability.

## 7.8 Mains adapter

The mains adapter is part of the medical device and helps to ensure its electrical safety. It must be installed near the medical device and must be readily accessible.

The mains cord connects the mains adapter to the medical device

- | Only use the mains adapter supplied with your medical device.

# 8 Disinfection and sterilising

The instructions relating to cleaning, disinfection and sterilisation protocols for accessories provided by SATELEC, a company of Acteon group have been approved for each medical device and accessory. The applicable guides are listed in the chapter *Associated documentation page 5*.

They can be downloaded at the following address: [www.satelec.com/documents](http://www.satelec.com/documents).

Download



Instructions For Use

In all cases, the local regulations in force relating to the cleaning, disinfection and sterilisation protocols for accessories take precedence over the information provided by SATELEC, a company of Acteon group.

## 8.1 Clean and disinfect the medical device

The medical device's control unit must be cleaned and disinfected daily.

The handpiece must be cleaned, disinfected and sterilised after each use.

Do not immerse the handpiece.

The medical device must be in OFF or O stop position during cleaning and disinfecting procedures.

Refer to the instructions in the chapter *Cleaning the irrigation system page 21*.

Use alcohol disinfectant wipes.

Avoid using cleaning and disinfection products that contain flammable agents.

Otherwise, ensure that the product has completely evaporated or that there is no fuel left on the medical device and its accessories before switching it on.

Do not use an abrasive product to clean the medical device.

Never apply sprays directly to the medical device to clean it. Always spray the product onto a wipe, then clean the medical device.

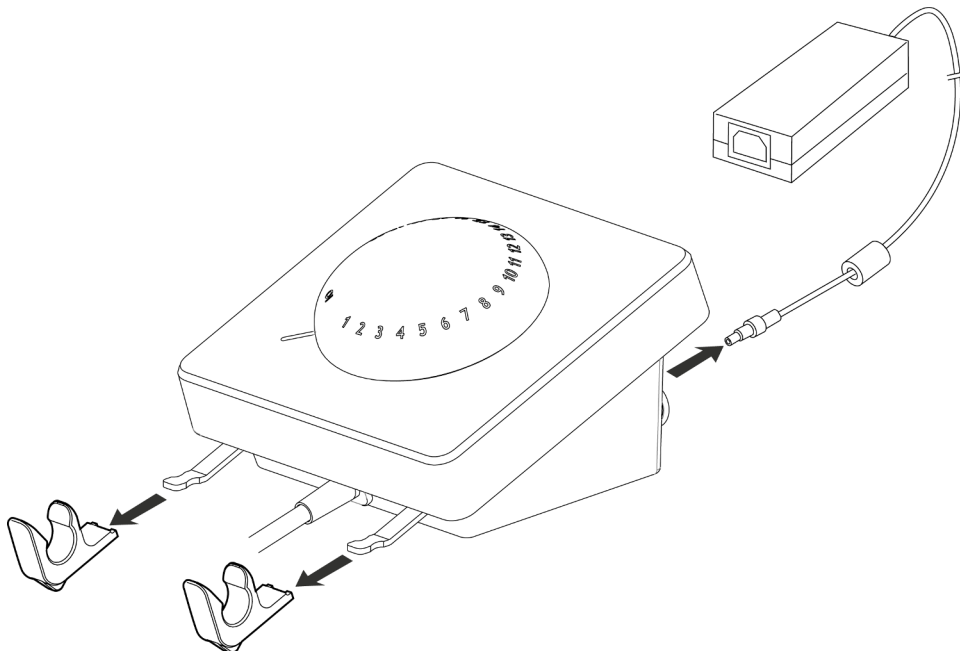

To prepare for cleaning, remove the various parts of the Newtron® Booster as shown here.

## 8.2 Cleaning, disinfecting and sterilising accessories

Refer to the cleaning, disinfection and sterilisation instructions for accessories listed in the chapter *Associated documentation page 5*.



# 9 Monitoring and routine maintenance

The only preventive maintenance the medical device requires is:

- Monitoring of accessories
- Routine cleaning, disinfection and sterilisation
- Cleaning

The medical device requires cleaning of the water filter cartridge.

Check the cleanliness of the air inlets on the control unit to prevent any heating.

Check the cleanliness of the handpiece nosepiece. It must be clean, smooth and corrosion-free. The handpiece must screw easily and firmly inside it.

Check the condition of the handpiece rear seals, which must not be distended, torn or broken.

Before and after use, check the medical device and its accessories entirely for any problems. This is necessary to detect any electrical isolation fault or damage. If necessary, replace damaged parts.

## 9.1 Cleaning the irrigation system

Operate the device at minimum power, at maximum irrigation flow rate for two minutes.

When the irrigation system has been cleaned, perform the following operations:

1. Disconnect the handpiece and refer to the handpiece cleaning, disinfection and sterilisation instructions [J12911].
2. Clean and disinfect the medical device as indicated in the chapter *Clean and disinfect the medical device page 19*.
3. Follow the instructions for cleaning, disinfecting and sterilising SATELEC, a company of Acteon group accessories [J81001] and [J02001].

## 9.2 Clean the water filter cartridge.

The water filter cartridge must be cleaned regularly. The water filter must be replaced every six months.

To clean the water filter cartridge, follow the steps below:

1. Stop the medical device (position O).
2. Unplug the electrical supply.
3. Shut off the water supply.
4. Disconnect the pipe from the device.
5. Unscrew the two filter sections.

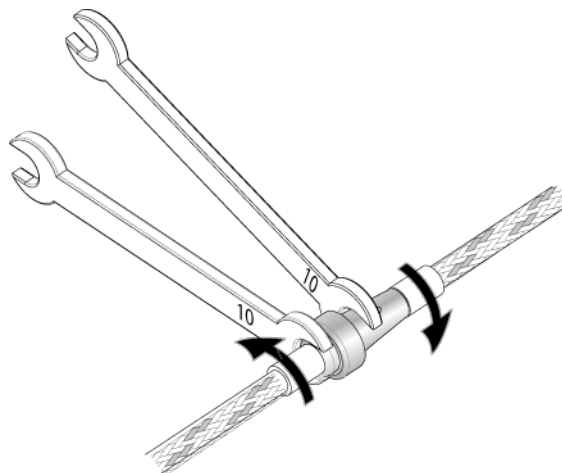

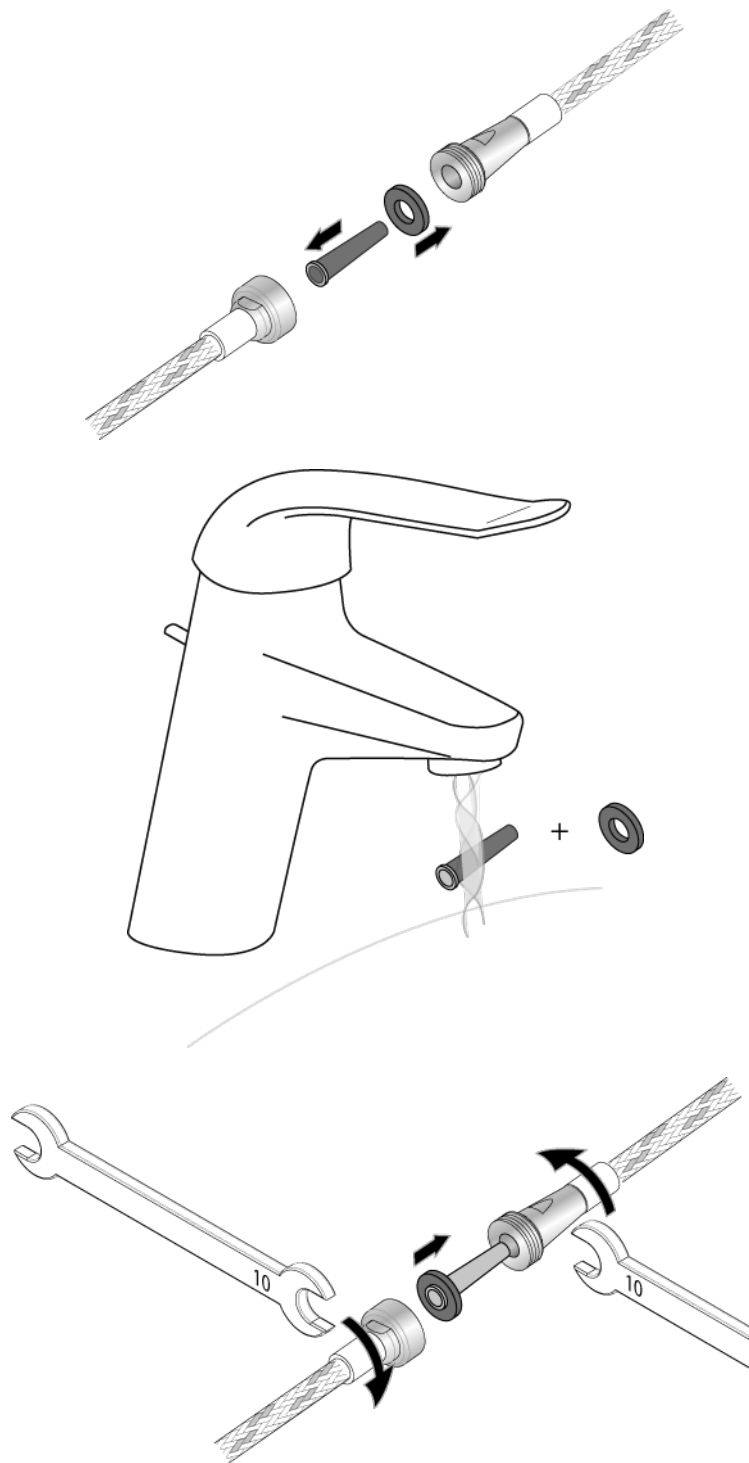

6. Check that there is no leakage and that the spray works correctly.  
| A damaged or blocked cartridge must be replaced.



# 10 Identifying incorrect operation

In the event of incorrect operation, refer to the tables below to quickly identify and repair the non-complex parts of the medical device.

If the incorrect operation is not described in the tables below, please contact your supplier or the customer service team at SATELEC, a company of Acteon group.

Do not use the medical device if it appears to be damaged or faulty. Isolate the medical device and make sure that it cannot be used.

## 10.1 Not working

Symptoms: the light indicator on the medical device is off and the medical device is not working.

Possible causes	Solutions
No electrical current	Contact your electrician
Mains switch in position O	Set the mains switch to position I
Faulty connection between the mains cord and the mains adapter	Connect the mains cord to the mains adapter
Faulty connection between the control unit and the mains adapter	Connect the mains adapter to the control unit
Internal fuse not working	Return to the Acteon Customer Service team

| The internal fuse (ref. FU1 on the printed circuit board) cannot be accessed by the user.

## 10.2 No spray

Symptom: There is no water spray at the tip.

Possible causes	Solutions
Main water supply closed	Open the main water supply
Flow configuration button on minimum	Adjust the flow control button
Faulty water pipe connection	Check the water inlet
Low water pressure	Check the main water system pressure
Blocked filter	Clean or replace the filter
Faulty solenoid valve	Return to the Acteon Customer Service team
Tip or file blocked	Unblock the tip or file using an ultrasonic tank
Incorrect choice of tip	Check the tip
Inadequate amount of spray	Adjust the spray

## 10.3 The power is not as expected

Symptoms: the tip does not vibrate at the expected frequency, the treatment is not progressing as normal and is taking longer or is at a standstill.

Possible causes	Solutions
Worn or bent tip	Replace the tip
Incorrect use: incorrect approach angle or inadequate pressure on the tooth	Refer to the user instructions available at <a href="http://www.acteongroup.com">www.acteongroup.com</a>
Presence of liquid or moisture between the handpiece and cord	Dry the electrical contacts
Faulty handpiece seal	Replace the handpiece seal using the purpose-provided kit.

## 10.4 Ultrasounds not working

Symptoms: the tip does not vibrate.

Possible causes	Solutions
Tip loose	Fasten the tip using the wrench Replace your torque wrench (once a year)
Faulty connector contact	Clean the cord contacts
Power configuration button in position O	Set the power configuration button to I
Handpiece cord wire(s) cut	Return to the Acteon Customer Service team to replace the cord

## 10.5 Water leakage

Symptoms: water is leaking between the base of the handpiece and its cord.

Possible causes	Solutions
Wear of 1.15 mm x 1 mm handpiece seal	Replace the seal using the purpose-designed kit.

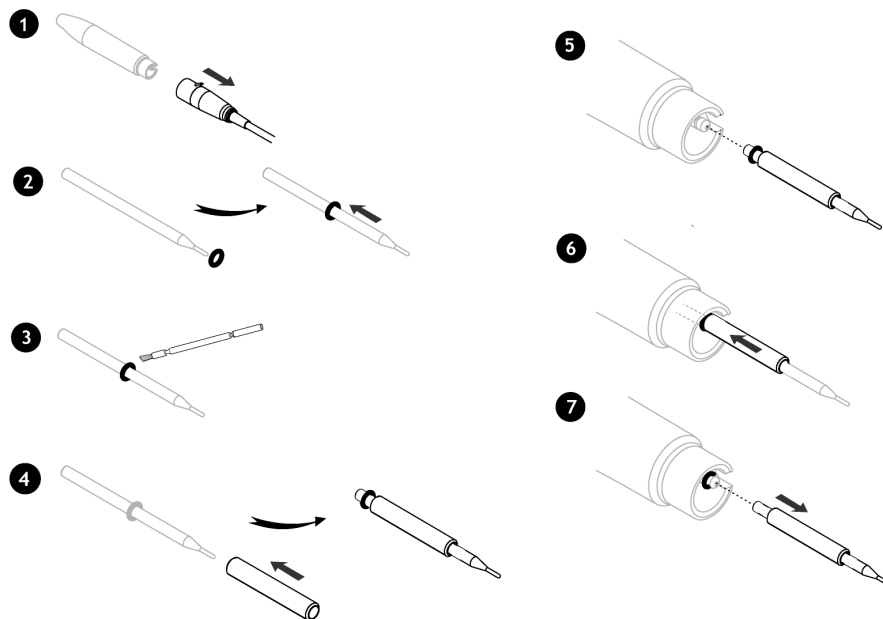

# 11 Technical specifications of the medical device

## 11.1 Identification

Manufacturer	SATELEC, a company of Acteon group
Name of the medical device	Newtron® Booster

## 11.2 Mains Adapter

Manufacturer	CINCON ELECTRONICS CO.LTD
Model	TR60M36
Type	medical 2 MOPP
Supply voltage	100 - 240 VAC
Input current	1.5 - 0.7 A
Power supply frequency	47 - 63 Hz
Power consumption	60 W
Output voltage	36 VDC
Output current	1.66 A
Width	58 mm
Height	31 mm
Depth	132 mm
Weight	381 g with mains cord

## 11.3 Generator

Supply voltage	36 VDC
Power consumption	25 W
Voltage supplied to handpiece	150 VAC
Output frequency	Minimum 28 kHz
Power setting range	1 - 20
Type of leakage currents	B
Operating mode	Intermittent: 10 minutes ON / 5 minutes OFF
Electrical rating	II
Internal fuse not accessible to the user	Ref : F1 / T 750 mAL 125 V – SMD - Interrupting capacity: 50 A
Width	130 mm
Height	88 mm
Depth	150 mm
Weight	1 008 g with pedal, water pipe and handpiece cord
Ingress protection rating	IPX0

## 11.4 Length of cords

Handpiece cord	2 500 mm +/- 50 mm
Control pedal cord	2 500 mm +/- 50 mm

## 11.5 Irrigation

Water pressure at inlet	from 1 to 5 bars (15 to 73 p.s.i.)
Maximum water output flow at the end of the handpiece	100 ml/min at 5 input bar

## 11.6 Footswitch

Width	67 mm
Height	25 mm
Depth	98 mm
Weight	150 g
Ingress protection rating	IPX1

## 11.7 Environmental characteristics

Ambient operating temperature	10 to +30°C
Operating RH	30% to 75 %
Atmospheric operating pressure	Between 800 hPa and 1060 hPa
Maximum operating altitude	Equal to or less than 2000 metres
Storage temperature	0 to +50°C
Storage RH	10% to 100 %, including condensation
Atmospheric storage pressure	Between 500 hPa and 1060 hPa
Transportation temperature	0 to +50°C
Transportation RH	10% to 100 %, including condensation
Atmospheric transportation pressure	Between 500 hPa and 1060 hPa

## 11.8 Environmental restrictions

Usage premises	Usable in all medical premises. The medical device must not be used in an operating theatre or outdoors.
Use in gas-filled atmosphere	The medical device is not designed for use in a type AP or APG gas-filled atmosphere or in the presence of anaesthetic gases.
Immersion	The console must not be immersed.
Immersion	The handpiece must not be immersed.

## 11.9 Main performance characteristics

Ultrasonic vibrations of the tip or file fitted to the end of the conventional dental ultrasonic handpiece.

- Vibration frequency  $\geq$  28 kHz.
- Tip amplitude  $\leq$  200  $\mu$ m.

# 12 Regulations and standards

## 12.1 Applicable standards and regulations









This medical device complies with the essential requirements of European Directive 93/42/EEC. It was designed and manufactured in accordance with an EN ISO 13485-certified quality assurance system.

















This equipment is designed and developed in compliance with the Electrical Safety standard IEC60601-1 in force.

## 12.2 Medical class of the device

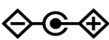

Class of medical device: IIa according to 93/42/EEC directive

## 12.3 Symbols

Symbol	Meaning
O	Switching off (OFF)
I	Switching on (ON)
 Protection Glasses Needed	Always wear safety goggles
	Always wear protective gloves
 Refer to Instruction Manual/Booklet	Refer to the supporting documentation
 Consult Instructions For Use	Consult the User Manual
 Electronic User Information	The accompanying documentation is available in electronic format
	Pressure limit
	Temperature limit
	Humidity limit

Symbol	Meaning
	Packaging unit
	Fragile, handle with care
	Store in a dry place
	Biohazard
	Sterilisation at 134°C in an autoclave
	Sterilisation at 132°C in an autoclave
	Washer-disinfector for thermal disinfection
	Type B part in contact
	Class II
	Alternating current
	Direct current
	Water connection
	Intensity
	Irrigation
	Direct current supply connector
	CE marking
	CE marking

Symbol	Meaning
YYYY 	Year of manufacture
	Manufacturer
 Do not dispose of as household waste	Do not dispose of as household waste
	Recycle your lamps and professional electrical equipment with Réylum
Rx Only	Under the United States Federal Law, this medical device must only be sold by or under the orders of a qualified doctor.
SN	Serial Number
PN	Packaging Number
	Use a dipping tank for cleaning
	Use a soft brush for cleaning
	Use a lint-free cloth for cleaning
	Use an ultrasonic tank for cleaning.
	Use a swab for cleaning
	Use deionised or osmosis-purified water for cleaning
	Use an alcohol disinfectant wipe for pre-disinfection and cleaning.
	Do not use the ultrasonic tank for cleaning.

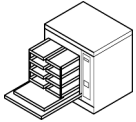
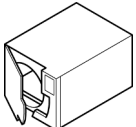
	Clean under running water
	Use a syringe for cleaning
	Use a washer-disinfector for cleaning and disinfection
	Use a pre-vacuum air autoclave for sterilisation

## 12.4 Manufacturer identification



**SATELEC**  
 A Company of ACTEON Group  
 17, avenue Gustave Eiffel  
 BP 30216  
 33708 MERIGNAC cedex  
 France  
 Tel. +33 (0) 556.34.06.07  
 Fax. +33 (0) 556.34.92.92  
 E.mail: [satelec@acteongroup.com](mailto:satelec@acteongroup.com).  
[www.acteongroup.com](http://www.acteongroup.com)





## 12.5 Branch addresses

### **U.S.A. & Canada**

ACTEON North America  
124 Gaither Drive, Suite 140  
Mount Laurel, NJ 08054 - USA  
Tel. +1 856 222 9988  
Fax. +1 856 222 4726  
info.us@acteongroup.com

### **GERMANY**

ACTEON GERMANY GmbH  
Industriestrasse 9 – 40822 METTMANN - GERMANY  
Tel. +49 21 04 95 65 10  
Fax. +49 21 04 95 65 11  
info.de@acteongroup.com

### **SPAIN**

ACTEON MEDICO-DENTAL IBERICA, S.A.U.  
Avda Principal nº11 H  
Poligono Industrial Can Clapers  
08181 SENTMENAT (BARCELONA) - SPAIN  
Tel. +34 93 715 45 20  
Fax. +34 93 715 32 29  
info.es@acteongroup.com

### **U.K.**

ACTEON UK  
Phoenix Park– Eaton Socon, St Neots  
CAMBS PE19 8EP - UK  
Tel. +44 1480 477 307  
Fax. +44 1480 477 381  
info.uk@acteongroup.com

### **MIDDLE EAST**

ACTEON MIDDLE EAST  
247 Wasfi Al Tal str.  
401 AMMAN - JORDAN  
Tel. +962 6 553 4401  
Fax. +962 6 553 7833  
info.me@acteongroup.com

### **CHINA**

ACTEON CHINA  
Office 401 - 12 Xinyuanxili Zhong Street -  
Chaoyang District - BEIJING 100027 - CHINA  
Tel. +86 10 646 570 11/2/3  
Fax. +86 10 646 580 15  
info.cn@acteongroup.com

### **THAILAND**

ACTEON (THAILAND) LTD  
23/45 Sorachai Building 16th floor - Sukumvit 63

Road, Klongton Nua - Wattana, BANGKOK 10110  
- THAILAND

Tel. +66 2 714 3295  
Fax. +66 2 714 3296  
info.th@acteongroup.com

### **Hong Kong Re. Office**

21/F, On Hing Building  
Central - Hong Kong  
Tel. +852 66 962 134  
info.hk@acteongroup.com

### **INDIA**

ACTEON INDIA  
1202, PLOT NO. D-9  
GOPAL HEIGHTS, NETAJI SUBASH PLACE  
PITAMPURA, DELHI - 110034 - INDIA  
Tel. +91 11 47 018 291 / 47 058 291 / 45 618 291  
Fax. +91 79 2328 7480  
info.in@acteongroup.com

### **LATIN AMERICA**

ACTEON LATINA AMERICA  
Bogotá - COLOMBIA  
Mobile: +57 312 377 8209  
info.latam@acteongroup.com

### **RUSSIA**

ACTEON RUSSIA  
Moscow, Gilyarovskogo str, 6b1  
+7 495 1501323  
info.ru@acteongroup.com

### **AUSTRALIA/NEW ZEALAND**

ACTEON AUSTRALIA/NEW ZEALAND  
Suite 119, 30-40 Harcourt Parade  
Rosebery NSW 2018  
Australia  
Tel. +612 9669 2292  
Fax. +612 9669 2204  
info.au@acteongroup.com

### **TAIWAN**

ACTEON TAIWAN  
11F., No.1, Songzhi Rd.  
Xinyi Dist., Taipei City 11047  
TAIWAN (R.O.C.)  
+ 886 2 8729 2103  
info.tw@acteongroup.com

## 12.6 Disposal and recycling

As an item of Electrical and Electronic Equipment, the medical device must be disposed of via a specialist collection, removal, recycling or destruction channel. This applies in particular to the European market, in reference to Directive 2002/96/EC dated 27/01/2003.

When your medical device has reached the end of its service life, contact your nearest dental equipment dealer, or the Acteon head office or one of the company branches to find out how to proceed. The relevant contact details are given in the chapter *Branch addresses page 31*.



| The indication below applies to France only.

In compliance with the provisions of the French Environment Code relating to the disposal of electronic and electrical equipment waste or WEEE (Decree no. 2012-617 dated 2 May 2012), our Company fulfils its obligations to reclaim and dispose of its electrical and electronic equipment through the means established by the approved organisation Réylum, NOR approval: DEVP1427651A.

As a manufacturer, our Company is listed in the National Register of Producers kept by the ADEME (French Environment and Energy Management Agency). Professionals buying our products directly from the distribution chain are responsible for passing on this information about our established recycling methods to the end user.

In addition, the buyer agrees to take back our brand's devices at the end of their service life and to transfer them to one of the collection centres set up by Réylum for recycling (see list of collection centres on the site <http://www.recylum.com/>).

If necessary, Réylum can come and collect these devices from you free of charge once the quantity of devices has reached a certain level in the pallets-containers with which you are provided to store this waste.



An accessory that has reached the end of its service life must be disposed of in infectious clinical waste containers.



# 13 Index

## A

altitude 26  
Amplitude 26  
approved dealers 7

## C

cartridge 21  
cleaned 15  
cleaning and disinfecting the device 21  
colour code 17  
conservative and restorative dentistry 7  
control pedal 13, 17  
control unit 17

## D

damage 21  
dental file 7  
disconnection devices 13  
disinfected 15  
disposal 32

## E

electrical safety 27  
electronic 5  
electronic user instructions 5  
endodontics 7  
European directive 27

## F

fault 21  
Filter 23  
first inclusion of CE marking 8  
Fuse 23

## G

gas-filled atmosphere 26  
general instructions relating to the complete range of  
ultrasonic dental generators 3

handpiece 5  
humidity 13

## H

## I

incorrect operation 23  
inlets 17, 21  
irrigation flow 17

## L

light indicator 17

## M

mains adapter 11, 18  
Mains power 11  
Manufacturer 25  
medical class 27

## P

periodontics 7  
power setting 11  
pressure 26  
procedure 17  
prophylaxis 7

## Q

Quick Clean 3, 5  
Quick Start 3, 5

## R

recycling 32  
Récyclum 32  
repair 7  
repairer 7

## S

seal 24  
slope of five degrees 13  
spray 17, 23

## Index: sterilised – wrenches

sterilised 15  
supply pipe 11  
switch 23

### **T**

temperature 26  
tip 5, 7, 23-24

### **U**

ultrasonic vibrations 7  
update 8  
User Manual 3, 5

### **V**

Vibration frequency 26

### **W**

water filter 21  
water system 11  
wrench 5  
wrenches 5



User Manual | Newtron® Booster | J60111 | V8 | (13) | 09/2017 | NBABEN030H

SATELEC S.A.S. | A Company of ACTEON Group  
17 av. Gustave Eiffel | BP 30216 | 33708 MERIGNAC cedex | FRANCE  
Tel. +33 (0) 556 34 06 07 | Fax. +33 (0) 556 34 92 92  
E-mail: [satelec@acteongroup.com](mailto:satelec@acteongroup.com) | [www.acteongroup.com](http://www.acteongroup.com)

