



PDC125 PI

Operation Manual
Version 1.0

Installation Manual
Version 1.0



1. Introduction

Thank you for purchasing Smart Park®. Your Smart Park® is a multifunction system, the system functions as a supplemental feature on your vehicle to assist you in avoiding obstacles while reversing and for low speed forward movement (if additional module is installed).

The PDC system uses ultrasonic radar to alert you to the distance to any potential obstacle.

The system has many advanced features including:

- Variable Detection Range
- Variable sensitivity
- Self-test at startup to ensure accurate function.
- Learning capability to ignore vehicle mounted obstacle such as tow-bars and bicycle racks.
- Auto-mute option for use when towing or off-roading.
- Front system automatic activation system.

THE SYSTEM IS DESIGNED TO ASSIST YOU IN DETECTING OBSTACLES AND WILL NOT REPLACE SAFE DRIVING PRACTICE.

We hope you enjoy using the most advanced parking sensor system available. Please visit www.smartpark.net to view more technologically advanced automotive accessories!

Table of Content

Operations Manual.....	Pages 2 thru 6
Installation Manual.....	Pages 7 thru 17

Operations Manual

2. User Adjustable Settings

i. Speaker Volume Control

The front system and the rear system have separate speakers. To adjust the volume (or turn the system off), locate your speaker and use the volume switch on the side.



ii. Auto-Mute Button

At any time the Smart Park® system can be muted by pressing the automute button (see your installer for button location). This will mute the system until the vehicle ignition is turned off.

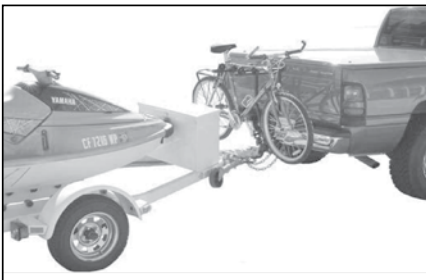

iii. Learning Capability

Your Smart Park® system can learn to ‘ignore’ vehicle mounted obstacles (eg tow-hitch, low rear-mounted tyre, bicycle rack etc..) that would otherwise cause false alerts. To ‘teach’ your vehicle to ignore these obstacles place the vehicle in reverse for 2 second. Place the vehicle in park / neutral for 1 - 2 seconds.

Repeat 4 times. When learning has been activated the LED will rotate in red-yellow-green silently followed by a long beep to confirm the training was successful.

To reset the system simply remove all obstacles and follow the same learning procedure.

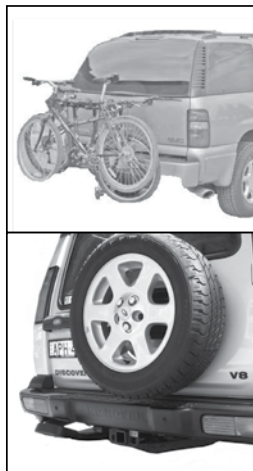

ATTENTION: Obstacles hidden from the sensor by a vehicle mounted obstacle will not be detected. The object must be fixed and not move in relation to the vehicle or it will be detected.

iv. Control Unit Switches



Your control unit will be mounted somewhere out of sight (ask you installer where). On the side of the unit are some dip switches that can change the function of your PDC system as outlined in the chart below (only adjust Switches 3 & 4):

SETTING	SWITCH 1	SWITCH 2	SWITCH 3	SWITCH 4
UP – “OFF”	Rear Bumper	4 Sensor	Full Detection (2.1m, 7ft)	High Sensitivity
DOWN – “ON”	Front Bumper	2 Sensor	Normal Detection (1.5m, 5ft)	Low Sensitivity

3. Basic Function

i) Rear Protection System

The rear sensors are activated when the vehicle is placed in reverse gear. The system will beep once to confirm successful self-check and then will remain silent unless an object is detected. On initial detection of an obstacle the system will beep slowly and the green LED will flash. As the vehicle nears the obstacle the beeping will increase and the yellow LED will flash. When the obstacle is within 1.3ft (40cm) of the vehicle a constant tone will be heard and the red LED will flash.

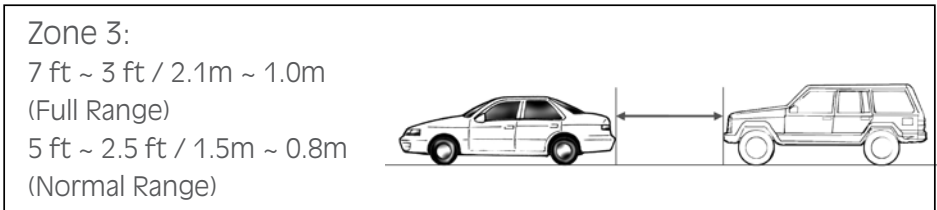

ii) Front Protection System

The front system is designed to be on permanently. If required the system can be turned off using the supplied on/off switch.

The system automatically reduces unwanted detection by going mute (silent) whenever the detection area is unchanged for more than four seconds. As soon as anything in the detection area (either the vehicle or the detected object) moves, the system becomes active again.

When the vehicle is within 2.5ft (80cm) of an obstacle the LED will flash yellow and the vehicle will begin beeping. When the vehicle is within 1.3ft (40cm) the LED will flash red and a constant tone will be heard.

There are only two zones in the front system:

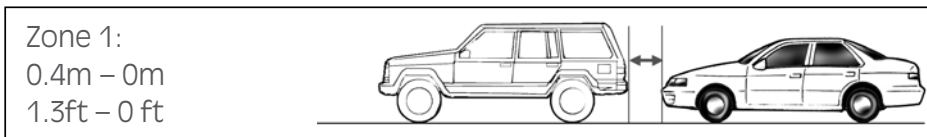
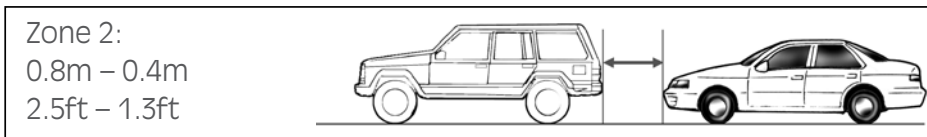

4. Trouble Shooting

All problems with Smart Park® must be repaired by an authorized provider. Should your Smart Park® unit not function correctly or should you hear more than the standard one beep self-check tone then immediately take the vehicle back for repair. Any unauthorized or attempted repairs to a Smart Park® component will void your warranty.

ATTENTION: DO NOT USE YOUR SMART PARK® SYSTEM IF YOU DO NOT HEAR A SINGLE SUCCESSFUL SELF-CHECK BEEP AT STARTUP.

5. Guarantee

This product is guaranteed by Zorg Industries for a period of three years from the date of purchase against defects due to faulty workmanship or materials. Service under guarantee is provided only upon presentation of evidence of purchase date and receipt of your warranty registration (see page 18).

This guarantee is not valid if the defect is due to accidental damage, misuse or neglect and in case of alterations or repairs carried out by unauthorized persons.

Service (during and after guarantee) is available at all outlets where the product is sold by authorized retailers. This product is a parking and distance aid. Zorg Industries is not responsible for any accident or injury to persons or property arising from use or misuse of this product.

Notes:

Installation Manual



1. Required Tools List

Screwdrivers
Marker pencil
Electric Drill
Smart Park® SPC-3 Drill bit
Smart Park® SPC-4 Drill bit
Pliers
Panel Removal Tool
Soldering Iron & Solder
Voltmeter
Safety Glasses

2. Supplied Parts List

Control Module
Sensors x 4
Sensor extension cables x 4
Odeg Sensor Supporters x 4
Speaker/LED Display x 1
Speaker LED Display extension cable x 1
Main wiring harness (Black,Red, Orange) x 1
On/Off/Mute Button x 1
Mounting Accessories (Tape, Screws, Fasteners)

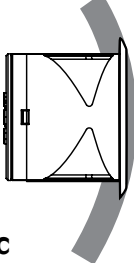
3. Application Guide

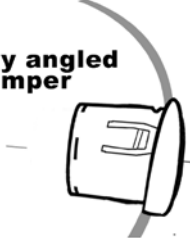
Bumper Type	Bumper Angle	Supporter	Cutter
 <p>Plastic</p>	+2° - -2°	Not Required	SPC-3
 <p>Plastic with metal support</p>	+2° - -2°	Yes-Flat	SPC-4
 <p>Plastic with metal support</p>	+2° - -2°	Yes-Flat	SPC-4
 <p>Any angled Bumper</p>	-2° - -10°	Yes - Angled	SPC-4

4. Painting Sensors & Supporter

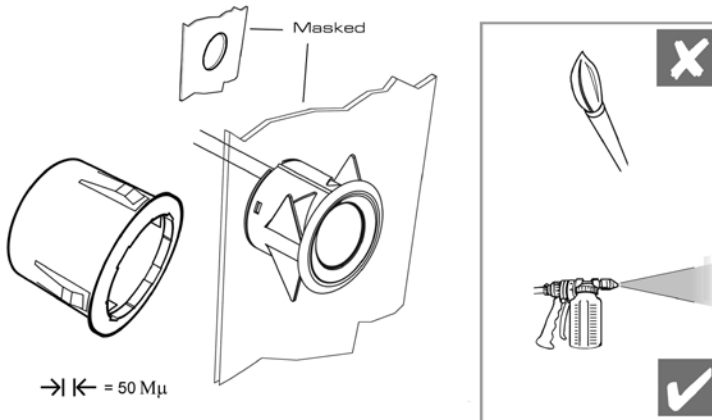

5. Position and Mark Bumper for Drilling

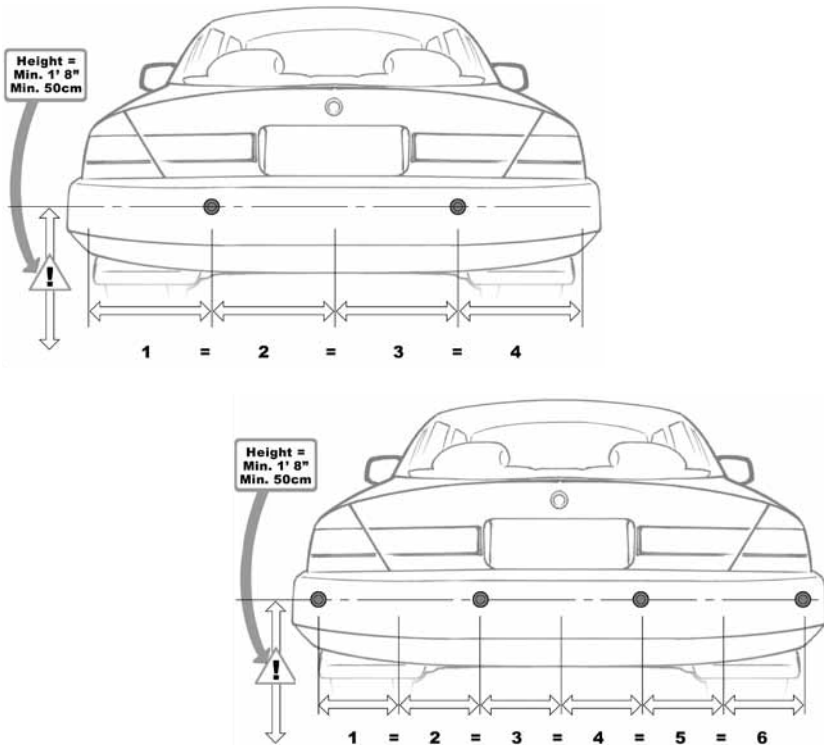

6. Insert Sensors into Supporter (if required)



Do not rotate sensor sideways



Align the small line on supporter with the top line on sensor

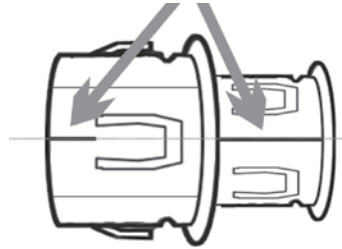

7. Drill Bumper – ONLY USE SPC cutter

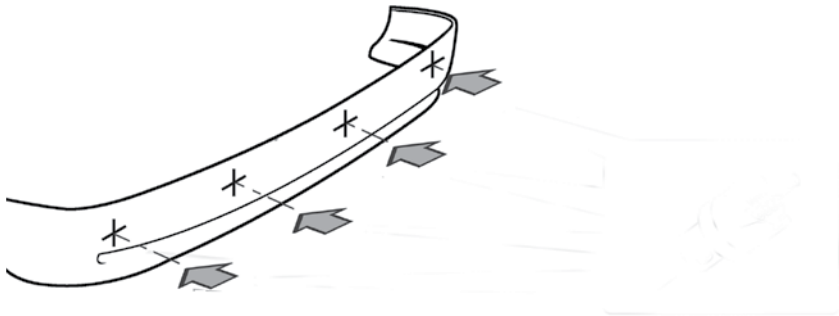

8. Insert Sensors into Bumper

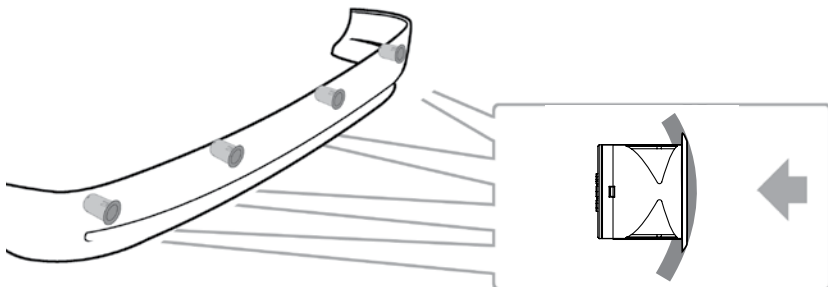

9. Connect Sensors into Extension cable



Caution! Please ensure the plug is securely pushed together and screwed tight! Ensure cable is attached to the correct sensor

10. Adjust Initial Control Unit Dip Switch Settings



SETTING	SWITCH 1	SWITCH 2	SWITCH 3	SWITCH 4
UP – “OFF”	Rear Bumper	4 Sensor	Full Detection (2.1m, 7ft)	High Sensitivity
DOWN – “ON”	Front Bumper	2 Sensor	Normal Detection (1.5m, 5ft)	Low Sensitivity

11. Mount Control Unit using detachable Velcro square



12. Install Speaker/LED and connect to Control Unit

Speaker can be mounted using the mounting point



or using the
supplied Velcro
tape



The speaker/LED should be placed in view of the driver – in the dash area for a front system or high at the back of the vehicle for a rear system.

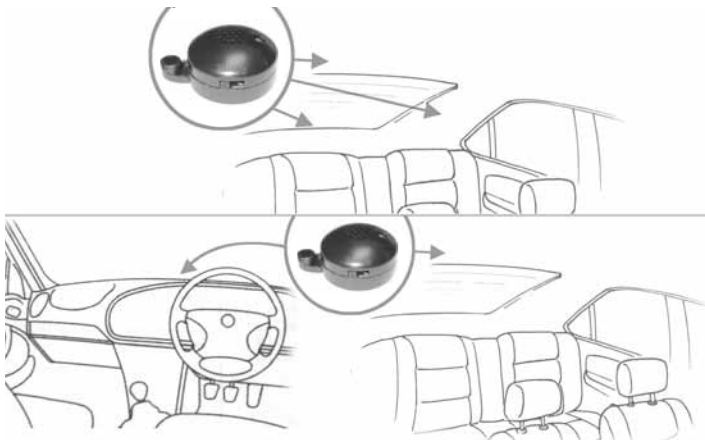

13. Install on/off/mute button and connect to control unit.



14. Connect Wiring Harness to Vehicle

Black – Ground (Use the ring terminal to connect ground wire to vehicle body directly)

Red – 12v Power (Reverse power for Rear system, Accessory power for Front system)

Orange – 12v Accessory Power (only required Rear system mute function)

15. Connect Sensors and Harness to Control Unit

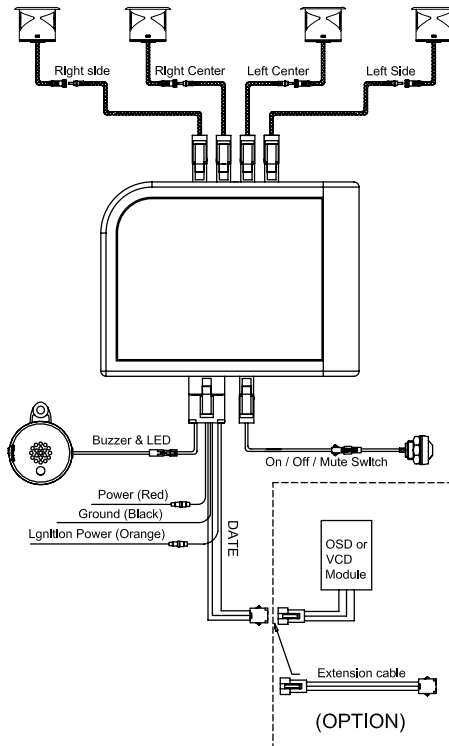

16. Activate Rear System & Test

Steps:

1. Start Vehicle
2. Place in Reverse Gear
3. Listen for 1 self-diagnostic beep and a green light of LED to confirm correct function.
4. Test system by reversing vehicle to each zone and checking accuracy. Ensure test obstacle will not damage car (such as cardboard) until test is successfully completed.

Zone 3:

7 ft ~ 3 ft / 2.1m ~ 1.0m (Full Range)

5 ft ~ 2.5 ft / 1.5m ~ 0.8m (Normal Range)



Zone 2:

3 ft ~ 1.3ft / 1.0m ~ 0.4m (Full Range)

2.5 ft ~ 1.3ft / 0.8m ~ 0.4m (Normal Range)

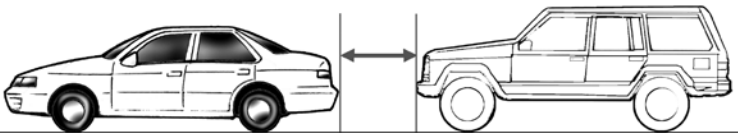

Zone 1:

1.3ft ~ 0 ft / 0.4m ~ 0m

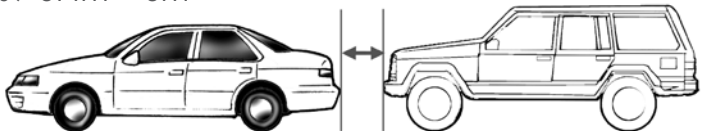

17. Set Learning System (if required)

If there is something mounted on the vehicle that is causing the sensors to false alarm (tow bar, rear mounted tyre, bicycle rack etc..) you can "train" the system to ignore these obstacles.



To activate learning mode:

Caution: The engine must be running when learning mode is set. Place the vehicle into and out of reverse 3 times at 1-2 second intervals. When the system is in 'learning' mode the LED will rotate in red-yellow-green silently followed by a long confirmation beep.

The rear system is now complete.

18. Activate FRONT System and Test

The front system should be active at all times. When the distance between the front of the vehicle and the obstacle remains exactly the same for 4 seconds or more the system will stop beeping.

19. Test Front System

There are only two zones in the front system:

Zone 2:

0.8m – 0.4m / 2.5ft - 1.3ft

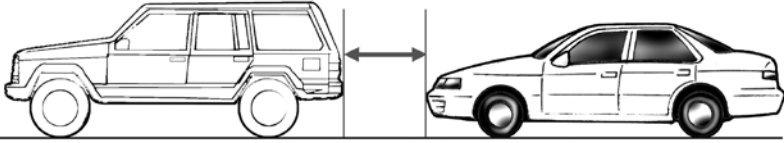

Zone 1:

0.4m – 0m / 1.3ft - 0ft

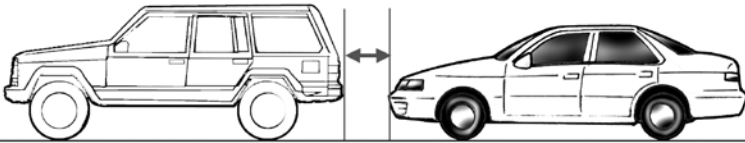

20. Diagnostics

The Smart Park® system performs a self-check on startup. Below is a brief diagnostic chart should there be a system fault.:

REAR BUMPER Sensor Speaker/LED Signals		
Speaker Sound	LED Display	
Long single beep	Yellow	System has been programmed
1 Beep	Green	System is functioning correctly
2 Beeps	Red	1 Sensor Disconnected/ Damaged
3 Beeps	Red	2-3 Sensors Disconnected/ Damaged
4 Beeps	Red	No sensors are connected
FRONT BUMPER Sensor Speaker/LED Signals		
Speaker Sound	LED Display	
No Sound	Green	Front system is active and functioning correctly
2 Beeps	Red	1 Sensor Disconnected/ Damaged
3 Beeps	Red	2-3 Sensors Disconnected/ Damaged
4 Beeps	Red	No sensors are connected
1 Brief Beep	Red	Button has been pushed and front sensors are active.
2 Brief Beeps	Red	Button has been pushed and front sensors are NOT active.

21. Apply Smart Park® Sticker

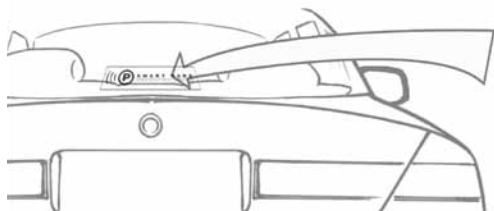

Smart Park® Warranty Card

PLEASE MAIL OR FAX THIS PAGE TO:

Att: PERFORMANCE GUARANTEE DEPT.,
International Fax #: +61-2-9437-4555

PO Box 124
Spit Junction NSW 2088
Australia

Section 1: VEHICLE INFORMATION

VEHICLE IDENTIFICATION NUMBER: _____

YEAR MODEL _____

MAKE LICENSE PLATE #: _____

PRODUCT SERIAL #: _____

Section 2: PURCHASE INFORMATION

DEALER NAME _____

DATE OF SALE _____

PURCHASE PRICE _____

BUYER'S NAME _____

Section 3: LIMITED WARRANTY

The Smart Park™ product is guaranteed to be free from mechanical defects for a period of three years when installed by an authorized Dealership.

Should your Smart Park™ system fail to perform return it to the original selling dealership for replacement. Smart Park® will replace it with a new or similar unit.

www.smartpark.net
For our full range of driver
assistance and safety products:



Reversing Sensors



4", 5.6", 7" Monitors



SmartFrame Cameras



**Commercial
Camera Systems**



Flex Camera



**Factory Display
Integration Units**



**LCD Mirror
Monitors**



**GM Bracket
Camera**



**HitchView Bumper
Camera**