

ROYALE

drive™



drive™

- US Drive Medical Design & Manufacturing, NY 11050
- UK Drive Medical Ltd, HX5 9JP
- DE Drive Medical GmbH & Co. KG, D-88316 Isny

CE Illustrations, photographs and specifications may be subject to change.

The team at Drive Medical develops its products to give our customers the freedom to live independently. This encompasses their daily home life and provides them with the opportunity to enjoy an outing with family and friends. Our goal is to develop a range that will provide individuals with a chance to enjoy every day life.

Royale Scooter Owner's Handbook

drive™

CONTENTS

1. Safety Instructions
2. Electromagnetic Interference (EMI)
3. Specifications
4. Comfort Adjustment
5. Control Panel Operation
6. Charging Instructions
7. Battery Instruction and Maintenance
8. Scooter Maintenance and Repair
9. Troubleshooting and Fault Repair
10. Warranty

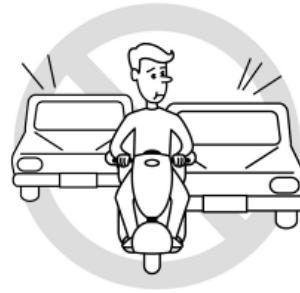

Do not ride your scooter in traffic.



Do not make a sharp turn or a sudden stop while riding your scooter.

SAFETY INSTRUCTIONS



Always use a seat belt, and keep your feet on the scooter at all times.



Never operate the scooter while you are under the influence of alcohol.



Do not attempt to climb kerbs greater than limitation shown in the specification



Do not remove your hands and legs from the scooter when driving.



Never use mobile phones or radio transmitters such as walkie-talkies.



Make sure that there are no obstacles behind you while reserving your scooter.



Do not ride your scooter during snow in order to avoid accidents.



Do not allow unsupervised children to play near this equipment while the batteries are charging.

◆ **Warning – Do not operate your scooter for the first time without completely reading and understanding this owner’s handbook**

1. Do not operate the scooter on public streets and highways. Be aware that it may be difficult for traffic to see you when you are seated on the scooter. Obey all local pedestrian traffic rules. Wait until your path is clear of traffic, and then proceed with extreme caution.
2. To prevent injury to yourself or others, always ensure that the power is switched off when getting on or off of the scooter.
3. Always check that the drive wheels are engaged (drive mode) before driving. Do not switch off the power when the scooter is still moving forward. This will bring the scooter to an extremely abrupt stop.
4. Do not use this product or any available optional equipment without first completely reading and understanding these instructions. If you are unable to understand the warnings, cautions or instructions, contact your dealer before attempting to use this equipment, otherwise, injury or damage may occur.
5. There are certain situations, including some medical conditions, where the scooter user will need to practice operating the scooter in the presence of a trained attendant. A trained attendant can be defined as a family member or care professional especially trained in assisting a scooter user in various daily living activities.
6. Do not attempt to lift or move a scooter by any of its removable parts including the armrests, seats or shrouds. Personal injury and damage to the scooter may result.
7. Never try to use your scooter beyond its limitations as described in this manual.
8. Please do not sit on your scooter while it is in a moving vehicle such as a car, bus or train.
9. Keep your hands away from the wheels (tyres) while driving scooters. Be aware that loose fitting clothing can become caught in the drive wheels.
10. Consult your physician if you are taking prescribed medication or if you have any certain physical limitations. Some medications and limitations may impair your ability to operate scooters in a safe manner. Consult with your physician if you are taking any medication that may affect your ability to operate your scooter safely.
11. Do not drive or sit on the scooter when in freewheel mode.
12. Do not remove the anti-tipper (if fitted)
13. Always switch off the scooter and charger, and disconnect the battery before doing any work or using any tools on the scooter.
14. Do not attempt to lift or move your scooter by any of its removable parts, such as the armrests, seats, or shroud.
15. Do not climb a gradient at an angle. Always drive straight up a gradient, as this greatly reduces the risk of tipping or a fall. Do not climb a gradient steeper than 10°.
16. Do not drive backwards down any step, kerb or other obstacle. This may cause the scooter to tip or fall.
17. Always reduce your speed and maintain a stable centre of gravity when cornering sharply. Do not corner sharply when driving scooters at higher speeds.
18. Operating in rain, snow, salt, mist and on icy or slippery surfaces may have an adverse affect on the electrical system.
19. Never sit on your scooter when it is being used in connection with any type of lift or hoist. Your scooter is not designed with such use in mind and any damage or injury incurred from such use is not the responsibility of Drive.

◆ **Modifications**

Your scooter has been designed to be as practical as possible. However, under no circumstances should you modify, add, remove, or disable any part or function of your scooter. Personal injury and damage to the scooter may result.

1. Do not modify your power scooter in any way not authorized by Drive. Do not use accessories if they have not been tested or approved for Drive products.
2. Get to know the feel of your power scooter and its capabilities. Drive recommends that you perform a safety check before each use to make sure your scooter operates safely.

◆ **Inspections prior to using your power scooter:**

1. If equipped with pneumatic tyres, please check for the tyres are not flat.
2. Please check all electrical connections and make sure they are tight and not corroded.
3. Please check all harness connections and make sure they are secured properly.
4. Please check the brakes.

◆ **Weight limitation.**

1. Do not exceed the weight capacity stated in the Specification section. Exceeding the weight capacity voids your warranty. Drive will not be held responsible for injuries or property damage resulting from failure to observe weight limitations.
2. Do not carry passengers on scooters. Carrying passengers on your scooter may affect the centre of gravity, resulting in a tip or a fall.

◆ **Tyre inflation**

1. If your scooter is equipped with pneumatic tyres, check the tyre pressure every week.
2. The correct tyre pressure will prolong the life of your tyres and ensure a smooth ride.
3. Do not under-inflate or over-inflate your

tyres. It is critically important that tyre pressure is maintained between 25 - 30 psi (2.0 - 2.4 bar).

◆ **Temperature**

1. Some of the parts of the scooter are susceptible to change in temperature. The controller can only operate in temperature that ranges between -25°C ~ 50°C (-13°F to 122°F).
2. At extreme low temperatures, the batteries may freeze, and your scooter may not be able to operate. In extreme high temperatures, it may operate at slower speeds due to a safety feature of the controller that prevents damage to the motors and other electrical components.

ELECTROMAGNETIC INTERFERENCE

The rapid development of electronics, especially in the area of communications, has saturated our environment with electromagnetic (EM) radio waves that are emitted by television, radio and communication signals. These EM wave are invisible and their strength increases as one approaches the source. All electrical conductors act as antennas to the EM signals and, to varying degrees, all power wheelchairs and scooters are susceptible to electromagnetic interference (EMI). The interference could result in abnormal, unintentional movement and/or erratic control of the vehicle. Power scooters may be susceptible to electromagnetic interference (EMI), which is interfering electromagnetic energy emitted from sources such as radio stations, TV stations, amateur radio (HAM) transmitters, two-way radios, cellular phones and alarm systems. The interference (from radio wave sources) can cause the power scooter to release its brakes, move by itself or move in unintended directions.

It can also permanently damage the powered scooter's control system. The intensity of the EM energy can be measured in volts per meter (V/m). Each powered scooter can resist EMI up to a certain intensity. This is called "immunity level". The higher the immunity level the greater the protection. At this time, current technology is capable of providing at least 20 V/m of immunity level, which would provide useful protection against common sources of radiated EMI.

Following the warnings listed below should reduce the chance of unintended brake release or powered scooter movement that could result in serious injury:

1. Do not turn on hand-held personal communication devices such as citizens band (CB) radios and cellular phones while the powered scooter is turned on.
2. Be aware of nearby transmitters such as radio or TV stations and try to avoid coming close to them.
3. If unintended movement or brake release occurs, turn the powered scooter off as soon as it is safe.
4. Be aware that adding accessories or components, or modifying the powered scooter, may make it more susceptible to interference from radio wave sources (Note: It is difficult to evaluate the effect on the overall immunity of the powered scooter).
5. Report all incidents of unintended movement or brake release to the powered scooter manufacturer, and note whether there is a radio wave source nearby.

TURN OFF YOUR POWERED SCOOTER AS SOON AS POSSIBLE IF YOU EXPERIENCE THE FOLLOWING:

- Unintentional scooter movements
- Unintended or uncontrollable direction.
- Unexpected brake release

The higher the immunity level the greater the protection. Your powered scooter has an immunity level of 20 V/m which should protect against common sources of EMI. Warning: The scooter itself can disturb the performance of the electromagnetic fields such as emitted by an alarm system

SPECIFICATION

Model	Royale 3
Weight Capacity (MUW)	185kg (29 stone)
Drive Wheel	41 x 10cm (16" x 4")
Front Wheel	41 x 9cm (16" x 3.5")
Maximum Speed	8mph (13kph)
Battery	12V x 70ah (2 pcs)
Maximum Range	50km (32 miles)
Charger Type	8A Off Board 120/240V
Controller	PG S-Drive
Motor Type	4100 RPM 1300W 21: 1
Turning Radius	126cm (49.5")
Suspension	Full
Maximum Gradient	10°
Length	158cm (62")
Width	73cm (29")
Height	135cm (53")
Seat Width	51cm (20")
Seat Height	71cm (28")
Seat Depth	46cm (18")
Back Height	70cm (27.5")
Wheel Base	104cm (41")
Ground Clearance	15cm (6")
Footwell	46cm (18")

Model	Royale Buggy
Weight Capacity (MUW)	160kg (25 stone)
Drive Wheel	48 x 12cm (19" x 4.7")
Front Wheel	36 x 9cm (14" x 3.5")
Maximum Speed	8mph (13kph)
Battery	12V x 70ah (2 pcs)
Maximum Range	60km (37 miles)
Charger Type	8A Off Board 120/240V
Controller	PG S-Drive
Motor Type	1500W DC 4-pole
Turning Radius	160cm (62")
Suspension	Full
Maximum Gradient	10°
Length	169cm (66.5")
Width	75cm (29.5")
Height	173cm (68")
Seat Width	51cm (20")
Seat Height	71cm (28")
Seat Depth	46cm (18")
Back Height	75cm (29.5")
Wheel Base	109cm (43")
Ground Clearance	12cm (5")
Footwell	33cm (13")

Model	Royale 4
Weight Capacity (MUW)	185kg (29 stone)
Drive Wheel	41 x 10cm (16" x 4")
Front Wheel	36 x 9cm (13" x 3.5")
Maximum Speed	8mph (13kph)
Battery	12V x 70ah (2 pcs)
Maximum Range	50km (32 miles)
Charger Type	8A Off Board 120/240V
Controller	PG S-Drive
Motor Type	4100 RPM 1300W 21: 1
Turning Radius	160cm (63")
Suspension	Full
Maximum Gradient	10°
Length	158cm (62")
Width	73cm (29")
Height	135cm (53")
Seat Width	51cm (20")
Seat Height	71cm (28")
Seat Depth	46cm (18")
Back Height	70cm (27.5")
Wheel Base	100cm (39")
Ground Clearance	15cm (6")
Footwell	46cm (18")

Note:

Maximum Range and Speed are based on optimal conditions. User weight, battery condition, temperature, terrain, gradient, weather conditions and driving style may all reduce the maximum range and speed.

Drive Medical Ltd reserves the right to change specifications without prior notice. Specifications of the product purchased may differ from those stated.

ADJUSTMENTS FOR COMFORT

Adjustments for Seating Comfort

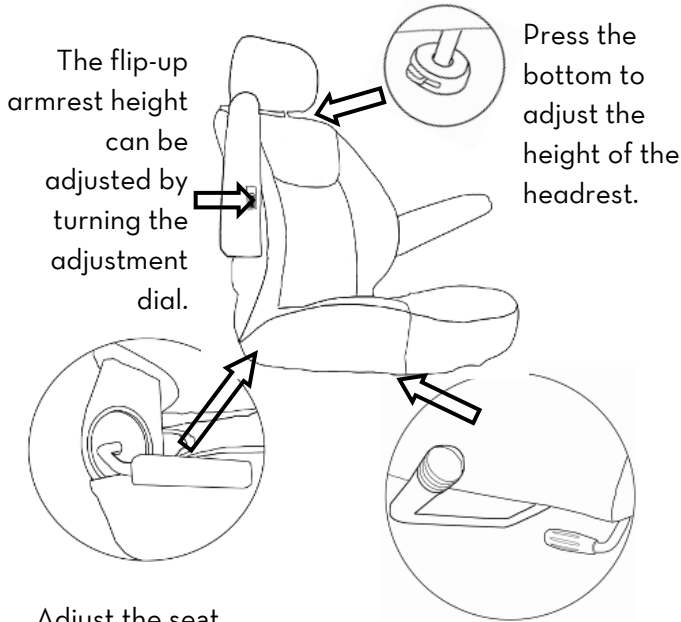

- Turn the swivel lever downwards to rotate the seat.
- Push the front lever upwards to move the seat forward and backward.

CONTROL PANEL OPERATION

Display

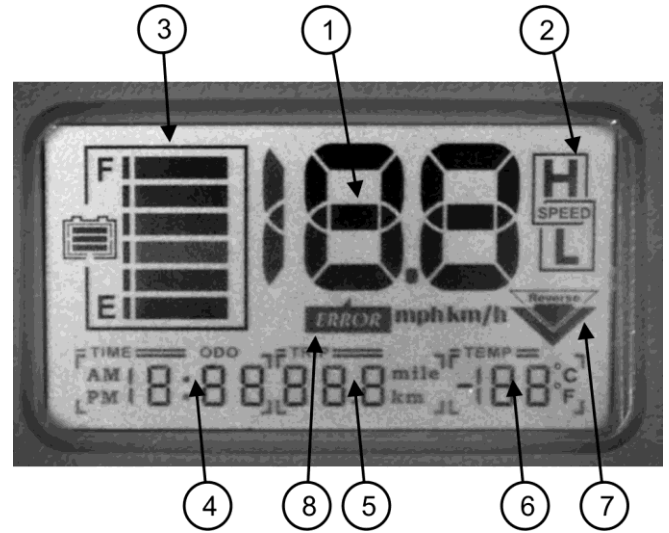

FUNCTION		Details
1	Speedo	Displays in mph or kph
2	High / Low / Turn Speed	Shows H or L top speed. Will flash for turn speed.
3	Power Indicator	Battery remaining capacity and charging indicator
4	Clock	Shows time.
5	Odometer	ODO (99999 km max), TRIP (99.9 max)
6	Temperature	"°C / °F" modes
7	Reverse Light	Flashes when reverse is engaged.
8	Error Message	Will illuminate when the scooter detects an error.



LED's



Left-Indicator (Green) (1)



Hazard Light (Red) (2)



Warning Light (Red) (3)



Parking lamp (Amber) (4)



Headlight (Blue) (5)



Right- Indicator (Green) (6)

Buttons

Left-Indicator (7)

High / Low speed (8)

Horn (9)

Right-Indicator (10)

Hazard Light (11)

LCD Display (12)

Headlight button (13)

'MODE' switch (14)

'SET' switch (15)

Side lights control (16)

(a) Braking

The scooter has an electromagnetic brake which operates automatically when the speed lever is released. It also features a cable brake which can be operated by the user. To operate the cable brake, squeeze the lever on the left hand side of the handlebars.

(b) Speed Lever (Throttle)

The user moves the scooter by moving the lever on the right hand side of the handlebars. The more the user moves the lever, the faster the scooter will travel. Release the lever to stop the scooter.

(c) Forward / Reverse

To allow the scooter to move forward press the 'F' side of the Forward / Reverse button (located on the right hand side of the handlebar).

To allow the scooter to reverse press the 'R' side of the button. When the 'R' side is pressed the scooters indicators will flash and a buzzer will sound to alert people that the scooter is reversing. Always ensure that you check behind you and use your mirrors when reversing.

(d) Speedo Operation

The speedo will show the speed the scooter is currently travelling at in miles per hour (mph) or kilometers per hour (kph).

To change the speedo to show mph or kph:

1. Hold down the MODE and SET buttons until the clock starts flashing.
2. Then press the MODE button until the kph or mph is flashing
3. Then press SET to change to the required setting.

4. Leave the scooter until the display stops flashing, or hold down the MODE and SET buttons for 2 seconds.

(e) **High / Low / Turn Speed**



To select high speed, press the HIGH / LOW button until the display shows 'H' (as shown)



To select low speed, press the HIGH / LOW button until the display shows 'L' (as shown)

If the display is flashing 'L', then scooter is automatically limiting its speed. As a safety feature the scooter will automatically limit its speed when cornering.

(f) **Power Indicator**

The remaining power in the battery is shown by the display status below:

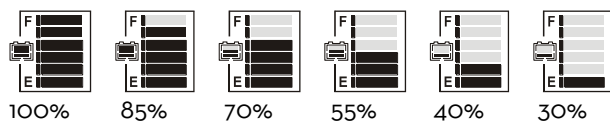

Once the power level drops below 30%, the gauge will flash and the warning sound will beep at 5 second intervals, informing the user to recharge the batteries as soon as possible.

(g) **Clock**

To change the clock:

1. Hold down the MODE and SET buttons until the clock starts flashing.
2. Then press the MODE button until the hour is flashing.
3. Then press SET to change until the hour is at the required setting

4. Press the MODE button again so the minutes are flashing
5. Press the SET to change until the hour is at the required setting
6. Leave the scooter until the display stops flashing, or hold down the MODE and SET buttons for 2 seconds.

(h) **Odometer**

When the scooter is first started it will show ODO and the total mileage of the scooter for 5 seconds.

After this the scooter will show TRIP and the trip distance.

To reset the trip counter, hold the SET button down for 3 seconds.

(i) **Headlight**

Press the HEADLIGHT button to switch on the headlight. Press the button again to switch off the headlight.

(j) **Side Lights**

Press the SIDE LIGHT button to switch on the headlight. Press the button again to switch off the headlight.

(k) **Indicators**

Press the RIGHT INDICATOR or LEFT INDICATOR button to operate the indicator, which will flash and a buzzer will sound. Press the button again to stop the indicator.

(l) **Hazard Warning Light**

Press the HAZARD button to operate the hazard warning light, which will flash and a buzzer will sound. Press the button again to stop the lights.

(m) **Temperature**

The temperature gauge will show the ambient temperature in °C or °F

To change the temperature to °C or °F:

1. Hold down the MODE and SET buttons until the clock starts flashing.
2. Then press the MODE button until the temperature gauge is flashing.
5. Then press SET to change to the required setting.
6. Hold down the MODE and SET buttons for 2 seconds.

When the scooter is first switched on, all the display will light up for 3 seconds whilst the scooter runs a self test.

If the scooter finds an error during this time or during operation, the error code will show on the display, the red WARNING light will show and the speedo will display a number (see below):



The error codes shown are shown below:

No.	Error	Remedy
1.	Battery	Recharge batteries and check battery connections
2.	Motor	Check motor connections
3.	Short Circuit	Check battery and motor connections
6.	Inhibit	Check charger is not connected
7.	Throttle fault	Release speed lever and restart scooter
8.	Controller fault	Restart scooter
9.	Brake fault	Check the scooter is not in freewheel mode.
10.	Overvoltage	Poor battery condition

BATTERY CHARGING

1. APPEARANCE

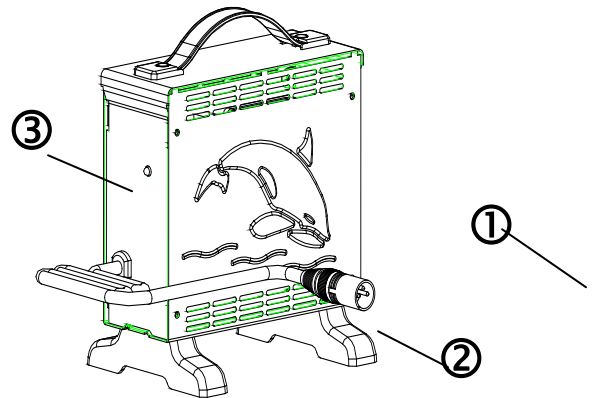

2. SPECIFICATION

- ① Power Cord
- ② Output Plug to Battery
- ③ Indicator:
 - Green Flash: Power On
 - Orange Flash: Pre Charge
 - Orange: Charging
 - Green & Orange Flash: Charged 80%
 - Green: Full Charged
 - Red Flash : Defective

Item	BATTERY CHARGER (SWITCHING MODE)
Model	4C24080A
Output Current(DC)	8A±5%
Charging Voltage(DC)	28.8V
Floating Voltage(DC)	27.6V
Input Current (AC)	3.8A max.
Input Voltage(AC)	100 ~ 240 V 50/60Hz
Efficiency	AC-DC 85% min
Operating Temperature	0°C ~ 40°C
Switching Method	SWITCHING MODE
Charging Method	Constant current two stage constant voltage
Battery Application	24V Lead Acid Rechargeable Battery (26Ah ~ 100Ah)
Output Detection	1.Short Circuit Protection 2.Reverse Power Protection 3.Overheat Protection 4.Charging Plug Protection
Operating Humidity	20% ~ 85 %
Measure	L 185mm·W 130mm·H 195mm
Weight	1.7K g
Color	Blue

3. OPERATING INSTRUCTION

Plug in the power cord. The LED will flash green when mains power is on.

Connect the battery charger to the battery.

Start charging; please refer to 4. LED Description.

The scooter should be charged for 12 - 14 hours for a full recharge. Failure to do this could result in a reduced range.

4. LED DESCRIPTION

(1) Green Flash: Power on

(2) Orange: Charging

(3) Orange Flash: Pre charge

(4) Green & Orange Flash: Charged 80%.

(5) Green: Full charged (Floating charge)

(6) Red Flash: Defect

5. TROUBLE SHOOTING

If the LED is not lit :

- Check the mains power. If the socket is working then the charger has a fault.

If green LED keeps flashing and cannot turn orange or green :

- Check that the battery connector is connected properly.
- Check if there is any short circuit on the output connection.

If red LED keeps flashing :

- Check that the battery connection is reversed.
- Check that there is no short circuit on the output connection.
- Check that the ambient temperature is not too low (0°C or less)
- The battery charger may be defective if the red LED still keeps flashing.

Charging LED (orange) cannot turn to green :

- The battery might be defective, please stop charging and have the battery be repaired.

If the charging LED (orange) turns to green (fully charged) immediately :

- The battery may be already fully charged.
- The battery may be defective if the battery is not fully charged.

6. CAUTION

Before using the battery charger, read all instructions and safety labels.

- (1) Use the battery charger in a well-ventilated area
- (2) To avoid the risk of injury, charge only lead-acid or gel cell type rechargeable batteries.
- (3) Please turn off the power after charging and remove the charger from the scooter.



Important!

- Always charge your batteries in well ventilated areas.
- The charger is intended for indoor use only. Do not use outside, and protect from outside elements.
- For maximum performance, it is recommended that you replace both batteries at the same time if the batteries are weak.
- Recharge the batteries at least every two weeks, even if the scooter has not been used. Failure to do so will reduce the longevity of the batteries.

BATTERY MAINTENANCE

- Read through the charger operating instructions before using.
- Make sure you charge the battery every time after you use the scooter.
- Recharge the batteries at least every two weeks, even if the scooter has not been used. Failure to do so will reduce the longevity of the batteries.
- If the battery cannot be fully charged (Orange light cannot turn to Green) or if the Orange light turns to Green immediately, please report this to your dealer. The battery may be defective.
- The voltage difference between the two batteries on a power unit cannot be more than 0.5 V; the battery case should be inspected for cleanliness and evidence of damage.
- If the charger LED is lit red and the charger is connected to the scooter, check if the charger is defective or if the cable wiring connection is poor.
- Please keep the battery and connectors clean otherwise the charging and battery performance will be poor.

SCOOTER MAINTENANCE

Your power scooter is designed for minimal maintenance. However, like any motorized vehicle it requires routine maintenance. To keep your **scooter** for years of trouble-free operation, we recommend you follow the following maintenance checks as scheduled.

DAILY CHECKS

1. Visual check on the conditions of tyres.
2. Inspect the battery gauge on the display to determine if batteries need to be charged.

WEEKLY CHECKS

Your scooter comes with standard pneumatic tyres. Make sure to maintain the pressure of the tires between 30-35 psi.

MONTHLY CHECKS

Visually inspect the controller harnesses. Make sure that they are not frayed, cut or have any exposed wires.

SEMI-ANNUAL CHECKS

Check the motor brushes. We recommended that your authorized dealer inspect the brushes every six months or sooner if your power scooter is not operating smoothly. If inspection determines excessive wear on the brushes, they must be replaced or motor damage will result.

The brushes should be inspected for wear and colour of the braiding inside the spring. If the braiding is dark brown, red, silver, purple or gold then the brush needs replacing.

Warning! Failure to maintain the brushes could void the power scooter warranty.

To inspect or replace the motor brushes:

1. Unscrew the motor brush caps (by using a screwdriver on the caps shown by the white arrow).
2. Remove the brushes.
3. Inspect the brushes for wear (replace if less than 9mm)
4. Replace the brushes if necessary.

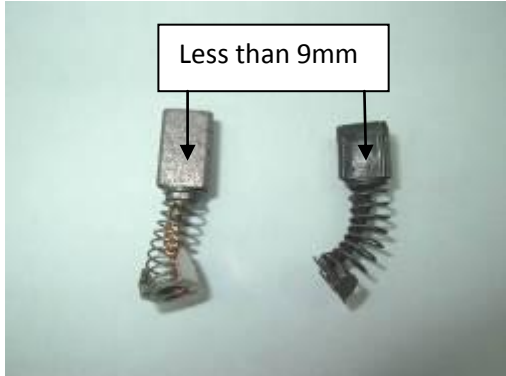
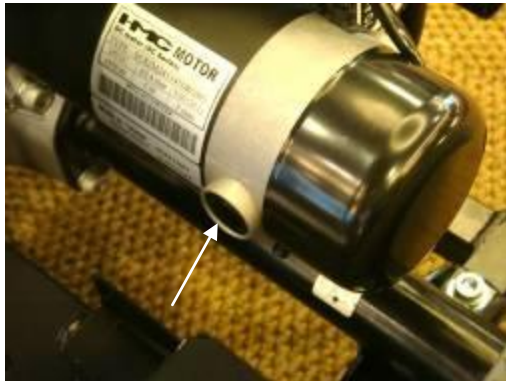

Inspect the state of the battery terminals every six months. Make sure that they are not corroded and the connections are tight. Periodically apply a thin film of petroleum jelly on the surface of terminals to guard against corrosion.

CHECKS:

- Make sure you keep the controller clean whilst protecting it from rain or water. Never hose off your scooter or place it in direct contact with water.
- Keep wheels free from lint, hair, sand and carpet fibres.
- Visually inspect the tyre tread. If less than 1mm (1/32"), please have your tyres replaced by your local dealer.
- All upholstery can be washed with warm water and mild soap. Occasionally check the seat and back for sagging, cuts and tears. Replace if necessary. Do not store your scooter in damp or humid conditions as this will lead to mildew and rapid deterioration of the upholstery parts.
- All moving mechanisms will benefit from simple lubrication and inspection. Lubricate using petroleum jelly or light oil. Do not use too much oil, otherwise small drips could stain and damage carpets and furnishings etc. Always perform a general inspection of the tightness of all nuts and bolts.

ANNUAL SERVICE

We recommend the scooter is servicing by annually by your dealer or competent technician. Service schedules are available from Drive Medical.

TROUBLESHOOTING AND FAULT REPAIR

S-DRIVE controller: Your scooter is fitted with a S-Drive controller, which continuously monitors the operating conditions of your scooter.

Error Number Reference	Fault	Impact on Scooter	Notes
1	Low Voltage	Error flashing	The battery requires charging or there is a bad connection to the battery.
2	Motor Connection	Scooter will not drive	There is a bad connection to the motor. Check all connections between the motor and controller.
3	Short Circuit	Scooter will not drive	The motor has experienced a short circuit to a battery connection. Check all motor and battery connections.
4	Not Used	Not Applicable	Not Applicable
5	Not Used	Not Applicable	Not Applicable
6	Inhibit	Scooter will not drive	Inhibit circuit has become active not permitting drive. Likely to be caused by a charger being connected or a fault within the controller or wiring.
7	Throttle Fault	Scooter will not drive	A throttle fault has been indicated. Ensure the throttle is in neutral before switching the scooter on. Throttle may require calibration.
8	Controller Fault	Scooter will not drive	A controller fault has been indicated. Make sure all connections are secure. Also cycle keyswitch as this fault can be initiated by a break in the circuit during keyswitch initiation.
9	Brake Fault	Scooter will not drive	There is a fault within the electromagnetic brake circuit, Check all brake and motor connections. Make sure controller connections are secure and that the scooter is not in freewheel mode.
10	Excessive Voltage	Scooter will not drive	An excessive voltage has been applied to the controller. This is very often caused by a poor battery connection. Check all connections from the batteries to the controller.

Note:

If you experience any technical problems, it is recommended that you check with your local dealer before attempting to troubleshoot on your own.

The following symptoms could indicate a serious problem with your scooter. Contact your local dealer if any of the following arises:

1. Motor noise
2. Frayed harnesses
3. Cracked or broken connectors
4. Uneven wear on any of tires
5. Jerky motion
6. Pulling to one side
7. Bent or broken wheel assemblies
8. Does not power up
9. Powers up, but does not move

WARRANTY

There is a comprehensive twelve-month warranty from the date on which your new scooter is delivered. The warranty covers the scooter for repairs or replacement during this period. For more detail, please see the Warranty Conditions below.

Warranty Conditions:

1. Any work or replacement part installation must be carried out by an authorized Drive Medical dealer / service agent.
2. To apply the warranty should your scooter require attention please contact the designated service agent listed above.
3. Should any part of the scooter require repair or full or part replacement, as a result of a manufacturing or material defect within twelve months of receiving the scooter, replacement parts will be supplied free of charge.

Note: This guarantee is not transferable

4. Any repaired or replaced parts will be covered by this warranty for the balance of the warranty period on the scooter.
5. Consumable items supplied will not generally be covered during the normal warranty period unless such items require repair or replacement clearly as a direct result of a manufacturing or material defect.
Such items include (among others): motor brushes, tyres, arm pads, seat cushion, fuses, bulbs, tiller cover, rear shroud, front shroud.
6. The above warranty conditions apply to brand new scooter purchased at the full retail price. If you are unsure whether your scooter is covered, check with the service agent.
7. Under normal circumstances, no responsibility will be accepted where the scooter has failed as a direct result of:
 - a) The scooter or part not having been maintained in accordance with the manufacturer's recommendations.
 - b) Failure to use the manufacturer's specified parts
 - c) The scooter or part having been damaged due to neglect, accident or improper use
 - d) The scooter or part having been altered from the manufacturer's specifications or repairs having been attempted before the service agent is notified

In the event of your scooter requiring attention, contact the stockist from where you bought the scooter and give all relevant details so they can act quickly.

The manufacturer reserves the right to alter without notice any weights, measurements or other technical data shown in this manual. All figures, measurements and capacities shown in this manual are approximate and do not constitute specifications.

This does not affect your statutory rights.

Appendix A: Service Record

YEAR	1	2	3	4	5	YEAR	1	2	3	4	5
Service Dates						Service Dates					
Controller						Upholstery					
On/off switch						Seat					
Control Lever						Back					
Braking						Armrests					
Recharge point						Electrics					
Batteries						Connections condition					
Levels						Lights					
Connections						Test run					
Discharge test						Forwards					
Wheels and Tyres						Reverse					
Wear						Emergency stop					
Pressure						Left turn					
Bearings						Right turn					
Wheel nuts						Slope test					
Motors						Over obstacles					
Wiring						List Items repaired					
Noise											
Connections											
Brake											
Brushes											
Chassis											
Condition											
Steering											

