

MIG180 WELDER

ASSEMBLY AND
OPERATING
INSTRUCTIONS

PrimeWeld



Need Help

Please Call

856-500-2000



CONTENTS

4	SAFETY WARNINGS AND PRECAUTIONS
10	UNPACKING
11	SPECIFICATIONS AND PARAMETERS
12	SETUP
22	BASIC WELDING
32	BASIC WELDING TECHNIQUE
35	WELDING TIPS
37	WELD DIAGNOSIS
38	WELD PROBLEMS
42	INSTALLATION SET-UP FOR SMAW (STICK) WELDING
43	OPERATION FOR SMAW (STICK) WELDING
44	SMAW (STICK) WELDING GENERAL DESCRIPTION
46	SMAW (STICK) WELDING FUNDAMENTALS
48	MAINTENANCE
53	PARTS LIST AND DIAGRAM

MIG180 MIG WELDER

Save This Manual

You will need the manual for safety warnings and precautions, assembly instructions, operating and maintenance procedures, parts list and diagram. Keep your invoice with this manual. Write invoice number and date of purchase on the inside of the manual. Keep the manual and invoice in a safe and dry place for future reference.

Operation Manual

Carefully read the operation manual prior to using, installing and maintaining the electric welding machine for the purpose of preventing damages such as fire, electric shock and etc from occurring. Please keep the manual for the reference in the future.

SAFETY WARNINGS AND PRECAUTIONS

WARNING: When using welder, basic safety precautions should always be followed to reduce the risk of personal injury and damage to equipment.

Read all instructions before using this welder.

Keep work area clean. Cluttered areas invite injuries.

Observe work area conditions. Do not use machines or power tools in damp or wet locations. Don't expose to rain. Keep work area well lighted. Do not use electrically powered tools in the presence of flammable gases or liquids.

Keep children away. Children must never be allowed in the work area. Do not let them handle machines, tools or extension cords.

Store idle equipment. When not in use, tools must be stored in a dry location to inhibit rust. Always lock up tools and keep them out of the reach of children.

Do not force tool. It will do the job better and more safely at the rate for which it was intended. Do not use inappropriate attachments in an attempt to exceed the tool capacity.

Use the right tool for the job. Do not attempt to force a small tool or attachment to do the work of a larger industrial tool. There are certain applications for which this welder was designed. Do not modify this welder and do not use this welder for a purpose for which it was not intended.

Dress properly. Do not wear loose clothing or jewelry as they can be caught in moving parts. Protective, flame retardant, electrically non-conductive cloths and non-skid footwear are recommended when working. Wear restrictive hair covering to contain long hair.

SAFETY WARNINGS AND PRECAUTIONS

Use eye and ear protection. Always wear **ANSI** approved, arc shaded, impact safety face shield(welding helmet). Always use full-face shield when welding. Always wear ANSI approved eyewear under face shield and while in the workplace. Wear a NIOSH approved dust mask or respirator when working around metal, chemical dusts, fumes and mists.

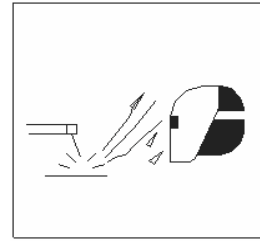

Do not over reach. Keep proper footing and balance at all times. Do not reach over or across running machines.

Maintain tools with care. Keep tools sharp and clean for better and safer performance. Follow instructions for lubricating and changing accessories. Inspect tool cords periodically and, if damaged, have them repaired by an authorized technician. The handles must be kept clean, dry, and free from oil and grease at all times.

Disconnect power. Unplug tool when not in use.

Remove adjusting keys and wrenches. Check that keys and adjustment wrenches are removed from the welder and work area before plugging in.

Avoid unintentional starting. Be sure the switch is in the off position when not in use and before plugging in. Do not carry any tool with your finger on the trigger, whether it is plugged in or not.

Stay alert. Watch what you are doing. Use common sense. Do not operate any tool when tired.

Check for damaged parts. Before using any tool, any part that appears damaged should be carefully checked to determine that it would operate properly and perform its intended function. Check for alignment and binding of moving parts; any broken parts or mounting fixtures; and any other condition that may affect proper operation. Any part that is damaged should be properly repaired or replaced by a qualified technician. Do not use the tool if any switch does not turn on and off properly.

Guard against electric shock. Prevent body contact with grounded surfaces such as pipes, radiators, ranges, and refrigerator enclosures.

SAFETY WARNINGS AND PRECAUTIONS

ARC WELDER SAFETY WARNINGS AND PERCAUTIONS
Warning: This product, when used for welding and similar applications, produces chemicals to cause cancer and birth defects (or other reproductive harm).

Replacement parts and accessories. When servicing, use only identical replacement part. Use of any other parts will void warranty. Only use accessories intended for use with this welder. Approved accessories are available from "**PRIMEWELD**".

Do not operate tool if under the influence of alcohol or drugs. Read warning labels on prescriptions to determine if your judgment or reflexes are impaired while taking drugs. If there is any doubt, do not operate the welder.

Maintenance. For your safety, service and maintenance should be performed regularly by a qualified technician.

Use proper size and type extension cord. If an extension cord is required, it must be of the proper size and type to supply the correct current to the welder without heating up. Otherwise, the extension cord could melt and catch fire, or cause electrical damage to the welder. This welder requires use of an extension cord of 30 feet, with a wire size rated at 10 AWG. Longer extension cords require larger size wire. If you are using the welder outdoors, use an extension cord rated for outdoor use, signified by "WA" on the jacket. Performance of this welder may vary depending on condition in local line voltage. Extension cord usage may also affect welder performance.

WARNING: The warnings, cautions and instructions discussed in this instruction manual cannot cover all possible conditions and situations that may occur. It must be understood, by the operator, that common sense and caution are factors, which cannot be built into this product, but must be supplied by the operator.

SAFETY WARNINGS AND PRECAUTIONS

Avoid electrical shock. Do not permit electrically live parts, cables, or electrodes to contact skin, clothing or gloves. Protective clothing should be hole free, dry and ANSI approved. This unit draws enough current to cause serious injury or death. Before turning the welder on, check the welder gun to be sure that there are no protruding screw heads and that all insulation is secure. Do not weld unless you are insulated from the ground and the work piece.



Avoid breathing fumes or gases. These gases can cause serious health problems. Use an active ventilation system directly above the welding area. Keep your head out of the fumes.

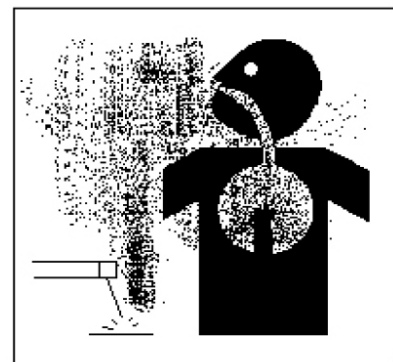

Avoid eye and body damage. Arc rays and infrared radiation can cause injury to the eyes and burn the skin. Wear ANSI approved eye and body protection. Do not allow viewing by visitors without proper eye and body protection.

Know proper arc welding practices. Read and understand the manufacture's instructions, as well as your employer's safety practices for arc welding.

Connect only to a code approved power source. Connect only to a grounding power source conforming to the National Electrical Code and Local Codes.

Avoid fire and explosion. Remove flammable and explosive material to a minimum of 35 feet from the welding arc to prevent welding sparks or molten metal from starting a fire. Keep a type ABC fire extinguisher within easy reach. Thoroughly clean the object being welded of any paint, grease or other foreign material.

Avoid being burned. Always wear ANSI approved welding gear: eye wear, leather gloves, leather apron and shoes.

ARC WELDING CAN BE HAZARDOUS

WARNING: THIS WELDING MACHINE MUST BE CONNECTED TO POWER SOURCE IN ACCORDANCE WITH LOCAL ELECTRICAL CODES

SAFETY WARNINGS AND PRECAUTIONS

WARNING: DISCONNECT POWER SOURCE BEFORE DISASSEMBLY OF THE TORCH
WARNING: THE SHIELD NOZZLE MUST BE INSTALLED PRIOR TO OPERATION OF THE TORCH

WARNING: ALL INSTALLATION, MAINTENANCE, REPAIR OPERATION OF THIS EQUIPMENT SHOULD BE PERFORMED BY QUALIFIED PERSONS ONLY IN ACCORDANCE WITH NATIONAL, STATE AND LOCAL CODES ELECTRIC SHOCK CAN KILL.

Improper use of electric arc welders can cause electric shock, injury and death! Take all precautions described in this manual to reduce the possibility of electric shock. The MIG180 power switch is to be in the OFF("O")position when installing work cable and gun and when connecting power cord to input power.

Always wear dry, protective clothing and welding gloves and insulated footwear. Always operate the welder in a clean, dry, well-ventilated area. Do not operate the welder in humid, wet, rainy or poorly ventilated areas.

Be sure that the work piece is properly supported and grounded prior to beginning the electric arc welding operation.

The electrode and work (or ground) circuits are electrically "hot" when the welder is on. Do not touch these "hot" parts with your bare skin or wet clothing.

Ground the work or metal to be welded to a good electrical (earth) ground.

FUMES AND GASES can be dangerous.

Do not breathe fumes that are produced by the arc welding operation. These fumes are dangerous.

Shielding gases used for arc welding can displace air and cause injury or death. Always use enough ventilation.

WELDING SPARKS can cause fire or explosion.

Do not operate electric arc welder in areas where flammable or explosive vapors.

Always keep a fire extinguisher accessible while performing arc-welding operations.



SAFETY WARNINGS AND PRECAUTIONS

ARC RAYS can burn.

Use a shield with the proper filter and cover plates to protect your eyes from sparks and the rays of the arc when welding or observing open arc welding.

Use suitable clothing made from durable flame resistant material to protect your skin and that of your helpers from the rays.

Protect other nearby personnel with suitable nonflammable screening or warn them not to watch the arc nor expose themselves to the arc rays or to hot spatter or metal.

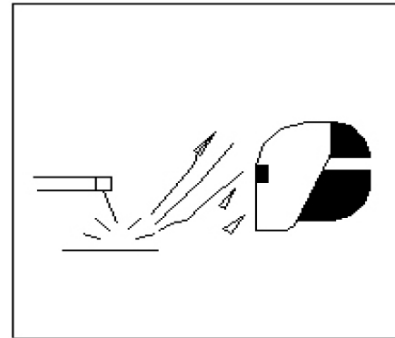

HOT METAL can burn

Electric arc welding operations cause sparks and hot metal to temperatures that can cause severe burns! Use protective gloves and clothing when performing any metal working operations.

Make sure that all persons in the welding area are protected from heat, sparks and ultraviolet rays. Use a face shields and flame resistant barriers as needed.

Never touch work piece until completely cooled.

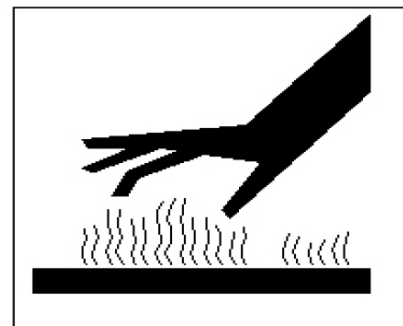

ELECTRIC AND MANGETIC FIELDS may be dangerous

The electric magnetic field that is generated during arc welding may interfere with the operation of various electrical and electronic devices such as cardiac pacemakers. Persons using such devices should consult with their physician prior to performing any electric welding operations. Exposure to electromagnetic fields during welding may have other health effects, which are not known.

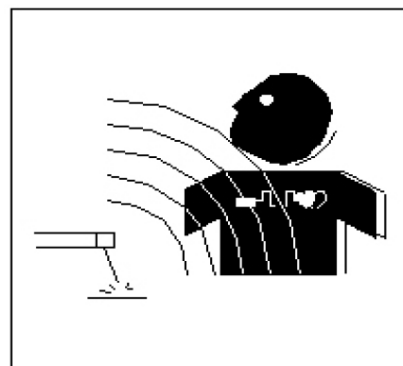

UNPACKING

Please check to ensure that the following components are included when unpacking (See Figure A-1)

FIGURE A-1



- 1 MIG180 Welder 2 Torch 3 Work Clamp 4 Electrode Holder
- 5 Gas Regulator 6 Gas Hose 7 Hand-hold Mask and Hammer Brush
- 8 2 lb. Spool of .030"(0.8mm)MIG Wire 9 .030"(0.8mm),.040"(1.0mm)Contact Tip
- 10 Operator's Manual 11 Spool Gun 12 Power Adapter
- 13 .023" -.030" / .035" V-groove Drive Roll
.030"/.035"-.045" Knurled-groove Drive Roll

SPECIFICATIONS AND PARAMETERS

Model Parameters	MIG 180	
Supply voltage (V)	1 phase 110V±15%	1 phase 220V±15%
Frequency (Hz)	60	
No-load voltage (V)	56	
Output current (A)	MIG:30-120 MMA:30-120	MIG:30-180 MMA:30-170
Output voltage (V)	MIG:15.5-20 MMA:21.2-24.8	MIG:15.5-23 MMA:21.2-26.8
Duty cycle (%)	30%	
Power factor	≥0.73	
Efficiency (%)	≥80	
Wire speed (in/min)	79-551	
Post flow (s)	1±0.5	
Wire diameter (in)	MIG:.023-.040 Flux-cored:.030-.040	
Appropriate thickness	≥ 22ga.	
Housing protection class	Ip21	
Insulation class	F	
Cooling method	Fan-cooled	
Weight (lb)	29.8	
Dimensions (in)	18.4*9.7*14.2	

NOTE: DUTY CYCLE is welding equipment specification, which defines the number of minutes, within a given time interval, during which a given welding machine can safely produce a particular welding current. It is usually expressed as a ratio of the uninterrupted no-load duration to the total time(usually 10 minutes).

SETUP



Read the **ENTIRE IMPORTANT SAFETY INFORMATION** section at the beginning of this manual including all text under subheadings therein before set up or use of this product.



WARNING

TO PREVENT SERIOUS INJURY FROM ACCIDENTAL OPERATION: Turn the Power Switch off and unplug the Welder before setup.

Note: Remove the protective foam and cardboard from the Welder before setup.

Wire Spool Installation/ Wire Setup

1

Turn the Power Switch OFF and unplug the Welder before proceeding.

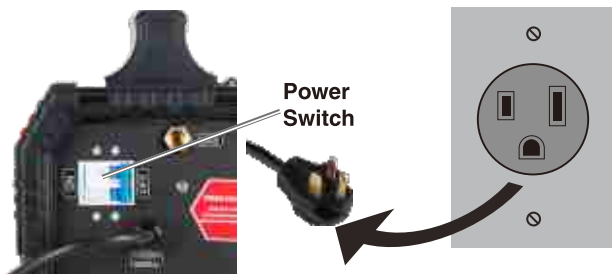

2

Pull up on the Door latch, then open the Door.



SETUP

3 10-12 Pound Wire Spool Installation:

Remove the Spool Knob.

4 Place the new Wire Spool over the Adapter and line up pin on Adapter with hole in Spool. **To prevent wire feed problems, set the Spool so that it will unwind counterclockwise.**

Notice: If wire Spool can spin freely, Spool Knob is too loose. This will cause the welding wire to unravel and unspool which can cause tangling and feeding problems.

5 Screw the Spool Knob into the Spool Adapter.

6 2 Pound Wire Spool Installation:

Remove the Spool Knob, Fastening Nut, Spring, Tab Washers and Flat Washers and Spool Adapter.

7 Place the new Wire spool over the Spool Spindle as illustrated in the picture. **To prevent wire feed problems, set the Spool so that it will unwind counterclockwise.**

8 Replace the Flat Washer, Tab Washer and Spring over the Spool Spindle and secure Spool in place with the Fastening Nut.

Notice: If wire Spool can spin freely, Fastening Nut is too loose. This will cause the welding wire to unravel and unspool which can cause tangling and feeding problems.

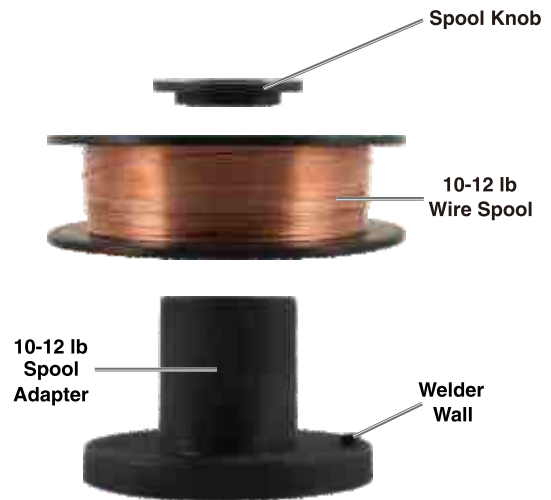

10-12 lb Spool Loading

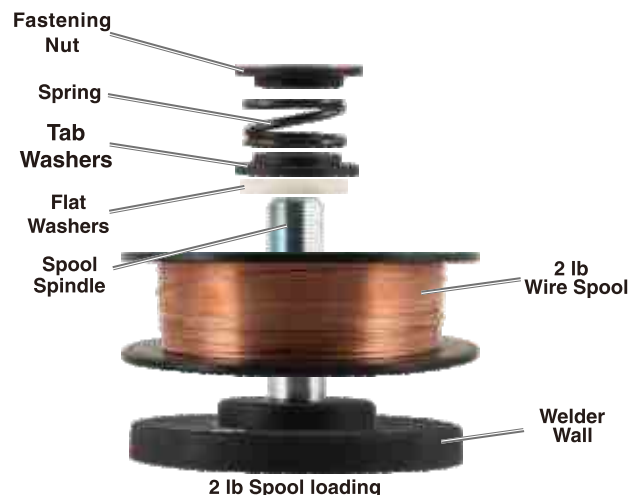
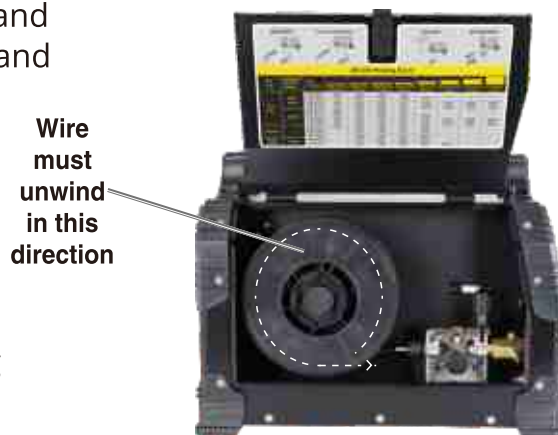

2 lb Spool loading

SETUP

9 DCEN Direct Current Electrode Negative Wire Setup for Flux Cored (gasless) welding:

Connect the Wire Feed Connector to the Negative Terminal on front of the Welder. Connect the Ground Cable to the Positive Terminal on the front of the Welder.



DCEN
Flux-Cored (Gasless) Polarity Setup

10 DCEP Direct Current Electrode Positive Wire Setup for Solid Core (gas shielded) welding:

- A Connect the Wire Feed Connector to the Positive Terminal on the front of the welder. Connect the Ground Cable to the Negative Terminal on the front of the Welder.
- B Determine which type of shielding gas would be appropriate for the welding you will do. Refer to the Welding Guide on the inside of the Welder door.



DCEP
Solid Core (Gas Shielded) Polarity Setup

- C With assistance, set the cylinder(not included) onto a cabinet or cart near the Welder and secure the cylinder in place with two straps(not included) to prevent tipping.

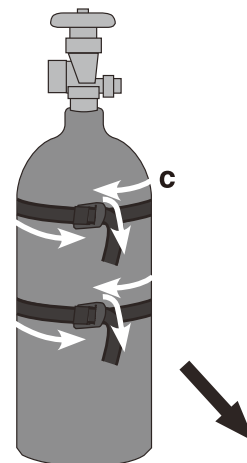

SETUP

D Remove the cylinder's cap. Stand to the side of the valve opening, then open the valve briefly to blow dust and dirt from valve opening. Close the cylinder valve.

E Locate the Regulator (included) and close its valve until it is loose, then thread Regulator onto cylinder and wrench tighten connection.

Note: When using C100 shielding gas, connect a CGA 580 adapter (not included) to the inlet connection of the Regulator and wrench tighten. Thread the adapter onto the gas cylinder and wrench tighten.

F Attach the Gas Hose (included) to the Regulator's outlet and Welder's gas inlet. Wrench tighten both connections.

11 Turn the Feed Tensioner knob counterclockwise to loosen it enough to pull it down to remove tension. The spring-loaded Idler Arm will move up as shown.

12 **Feed Roller Instructions**
Check that the Feed Roller is correct for the type of wire being used (solid core or flux-cored) and that it is turned to properly match the wire size marked on the Wire Spool:

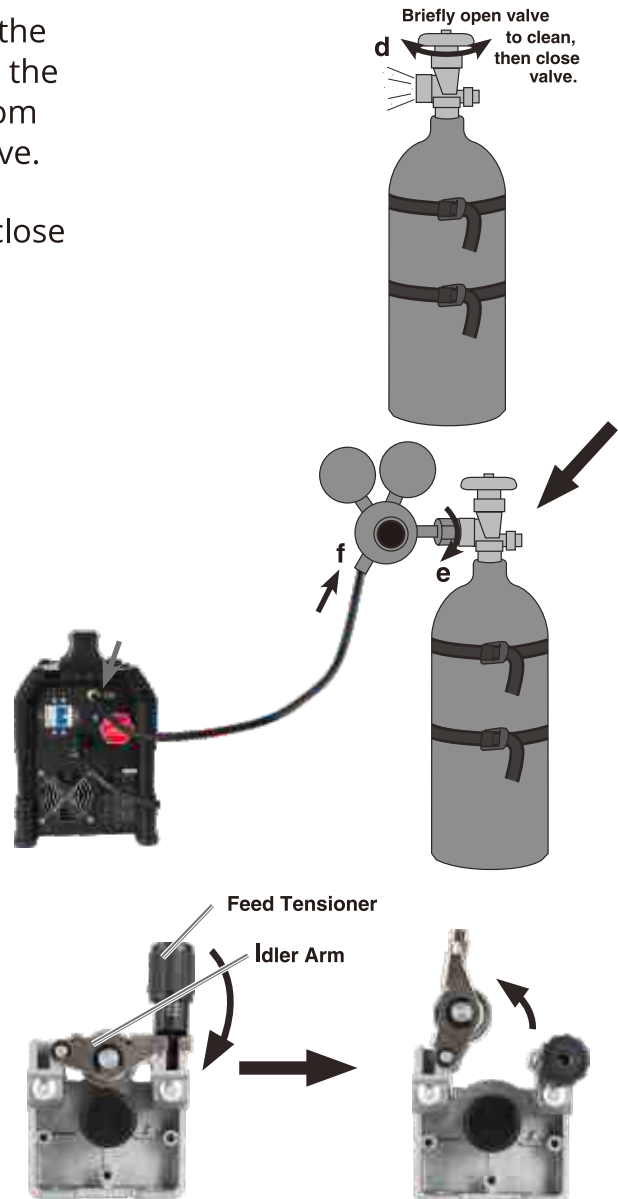

SETUP

- A** Unscrew the Feed Roller Knob counterclockwise.
- B** Remove the Feed Roller Knob to expose the Feed Roller.
- C** Flip or replace the Feed Roller as needed and confirm that it is the correct Roller for the type of wire being used and that the number showing is the same as the wire diameter on the Spool.

Note: The knurled groove is used for flux-cored wire. The V-grooves are used for solid/MIG wire.

- D** Screw the Feed Roller Knob back into place to secure the Feed Roller.

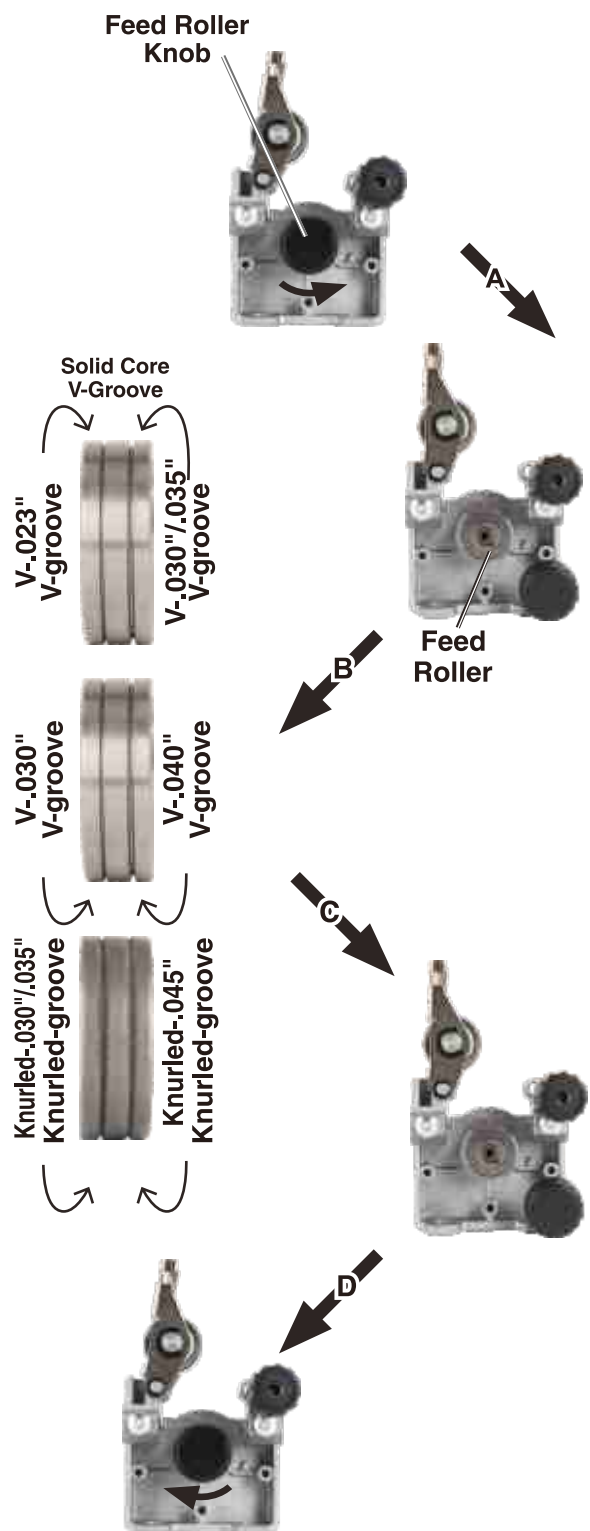

SETUP

13 Loosen the Knob on the Wire Feed mechanism, then insert the Gun Cable Connector through the hole on the Welder front and into the socket on the Wire Feed.

14 Ensure that the Gun Cable Connector is full inserted into the socket on the Wire Feed mechanism as shown. **No O-ring should be visible.** Tighten the Knob securely. If Connector is not fully inserted, the gas connection will leak, preventing shielding gas from reaching the welding arc.

NOTICE: To prevent the damage, do not overtighten the Knob.

15 Connect the Wire Feed Control Cable to the Wire Feed Control Socket located on the front of the machine. Press it in until the collar snaps into place. Note that the plug on the Cable fits into socket in one specific orientation only.

To disconnect it, pull the collar back first.

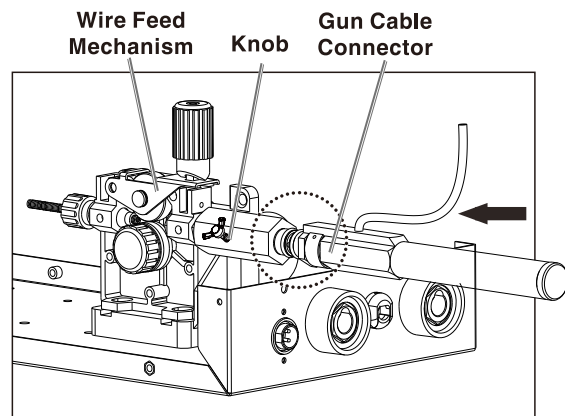

Incorrect-Connector not fully inserted

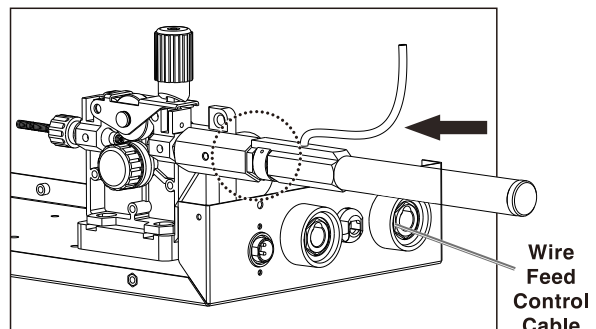

Correct-Connector fully inserted

IMPORTANT

Securely hold onto the end of the welding wire and keep tension on it during the following steps. If this is not done, the welding wire will unravel and unspool which can cause tangling and feeding problems.

SETUP

16 Cut off all bent and crimped wire. The cut end must have no burrs or sharp edges; cut again if needed.

17 Keep tension on the wire and guide at least 12 inches of wire into the Wire Inlet Liner and Feed Guide.

18 Make sure the welding wire is resting in the groove of the Feed Roller, then push the wire Idler Arm down, and swing the Feed Tensioner up to latch it across the tip of the arm. After the wire is held by the Tensioner, you may release it.

Note: The tension should be 3-5 for solid wire and 2-3 for flux-cored wire. Too much force on flux-cored wire will crush it and may cause feeding issues.

19 Pull and twist the Nozzle to remove it.

20 Unscrew the Contact Tip counterclockwise and remove.

21 Lay the MIG Gun Cable out in a straight line so that the welding wire moves through it easily. Leave the cover open, so that the feed mechanism can be observed.

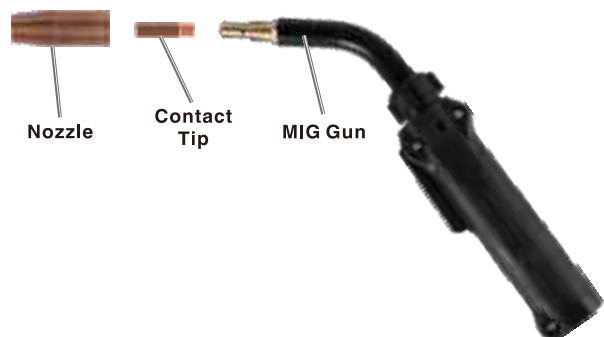
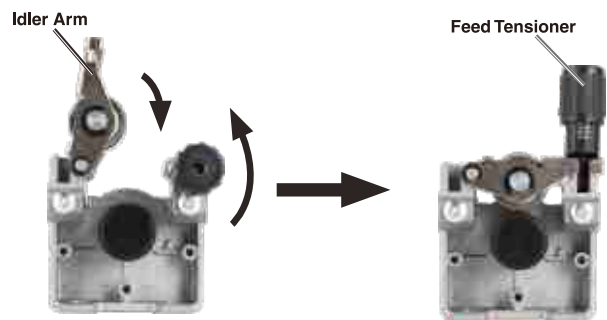
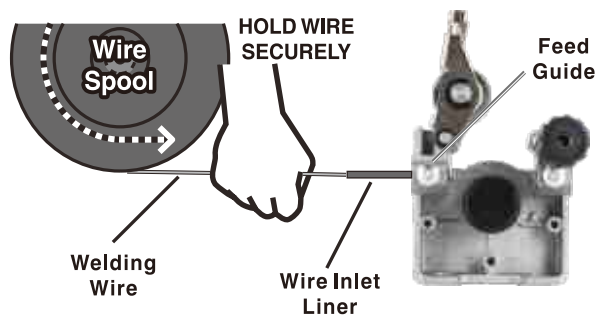

SETUP

IMPORTANT

Stainless steel wire is less flexible than other welding wire. Therefore, it is more difficult to feed through the liner and gun. It is especially important to keep the gun cable straight while feeding stainless steel wire.



⚠ WARNING

The following steps require applying power to the Welder with the cover open.

To prevent serious injury from fire or electric shock:

1. Do not touch anything, especially not the Ground Clamp, with the Gun or welding wire or an arc will be ignited.
2. Do not touch internal Welder components while it is plugged in.

22

Turn the Power Switch off and do not touch the Gun's Trigger and before connecting Power Cord: If using 110VAC, connect the included adapter to the end of the Power Cord. If using 220VAC, do not use the adapter. Plug the Power Cord into a properly grounded and rated receptacle that matches the plug and turn the Power Switch ON.

Note: The circuit must be equipped with delayed action-type circuit breaker or fuses.

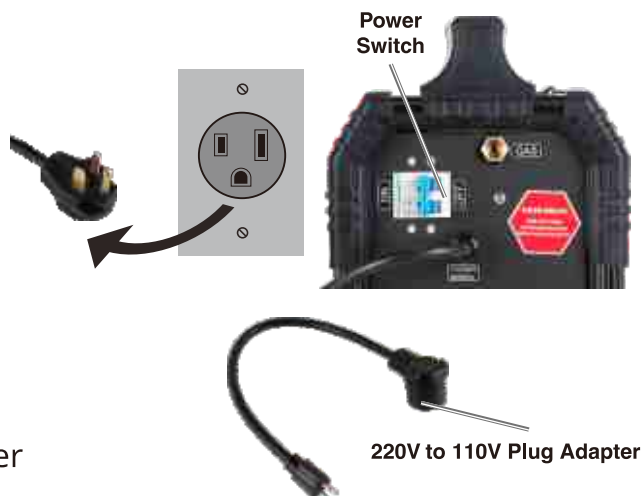

SETUP

- 23 Set the MIG Flux / Spool Gun Switch to MIG Flux Gun.

- 24 Point the Gun away from all objects. Press and hold the Trigger until the wire feeds through the end of the Gun two inches.

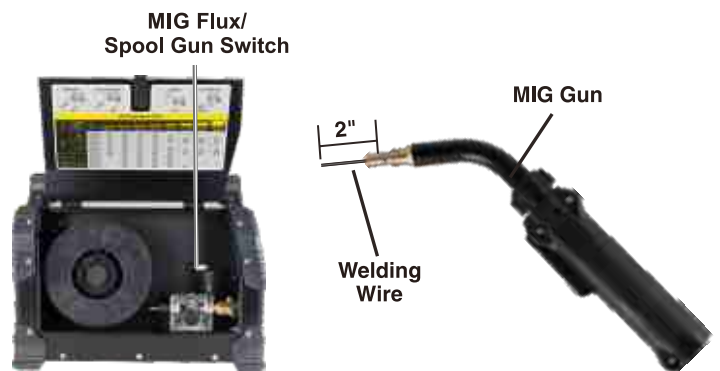

The wire liner may come out with the welding wire. This is normal, just turn off the Welder and push the wire liner back into the gun.

If the wire does not feed properly and the Spool is stationary, turn OFF and unplug the Welder and slightly tighten the Feed Tensioner clockwise before retrying.

- 25 To check the wire's drive tension, press and hold Trigger to feed the wire against a piece of wood from 2 to 3 inches away.

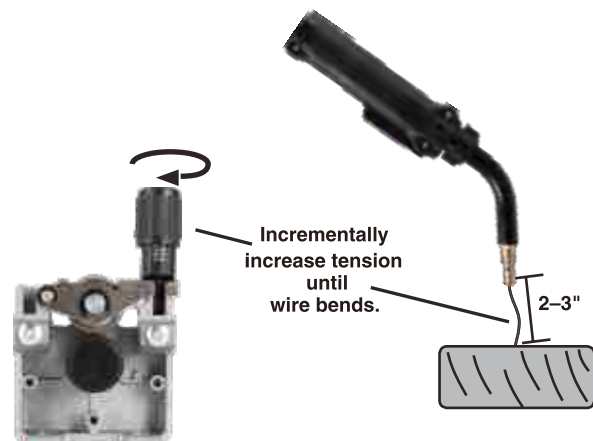

If the wire stops instead of bending, unplug the Welder, slightly tighten the Feed Tensioner clockwise, and try again. If the wire bends from the feed pressure, then the tension is set properly.

- 26 Turn OFF the Power Switch and unplug the Power Cord from its electrical outlet.

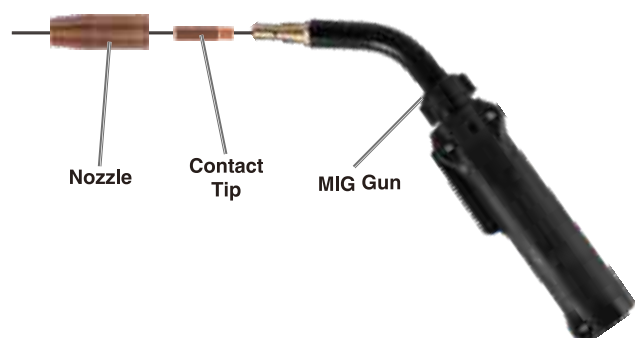

SETUP

27 Select a Contact Tip that is compatible with the welding wire used. Slide the Contact Tip over the wire and thread it clockwise into the MIG Gun. Tighten the Contact Tip.

28 Replace the Nozzle and cut the wire off at 1/2" from tip (1/2" stickout).

29 Close the Door. Make sure Door is securely latched.



BASIC WELDING



Read the ENTIRE IMPORTANT SAFETY INFORMATION section at the beginning of this manual including all text under subheadings therein before welding.

⚠️WARNING

TO PREVENT SERIOUS INJURY:

Protective gear must be worn when using the Welder; minimum shade number 10 full face shield (or welding mask), ear protection, welding gloves, sleeves and apron, NIOSH approved respirator, and fire resistant work clothes without pockets should be worn when welding.

Light from the arc can cause permanent damage to the eyes and skin. Do not breathe arc fumes.

Flux-cored wire welding is used to weld mild steel and stainless steel without shielding gas.

MIG welding uses solid wire and shielding gas, and is used to weld mild steel and stainless steel. MIG welding can also be used to weld thinner workpieces than flux-cored welding can.

Aluminum welding can be performed with an optional Spool Gun (included) using aluminum wire and shielding gas. Good welding takes a degree of skill and experience.

Practice a few sample welds on scrap before welding your first project. Additional practice periods are recommended whenever you weld: Good welding takes a degree of skill and experience. Practice a few sample welds on scrap before welding your first project. Additional practice periods are recommended whenever you weld:

- a different thickness of material
- a different type of material
- a different type of connection
- using a different process (MIG vs. Flux)



BASIC WELDING

Make practice welds on pieces of scrap to practice technique before welding anything of value.

⚠️WARNING



**TO PREVENT SERIOUS INJURY,
FIRE AND BURNS:**

Keep welding tip clear of grounded objects whenever unit is plugged in and turned on.

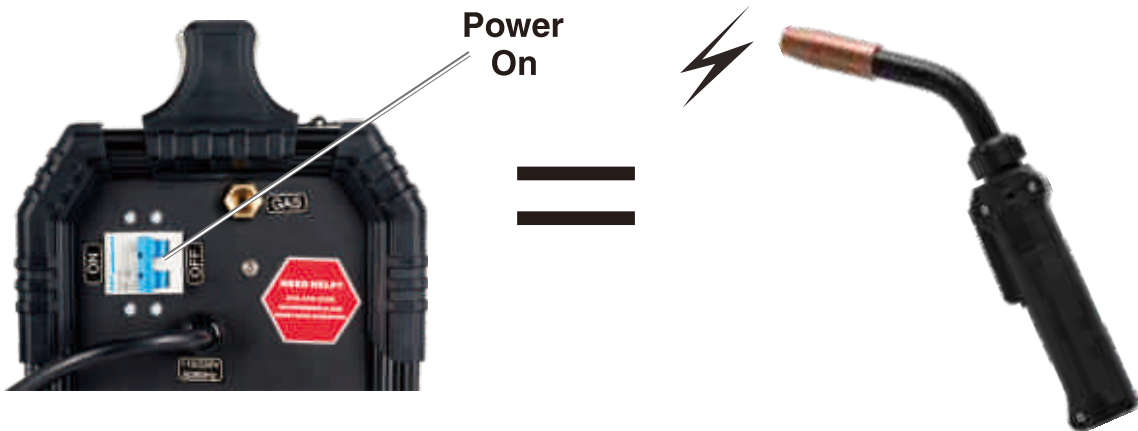

Practice your welding technique on scrap pieces before welding anything of value.

BASIC WELDING

Front Panel Controls



BASIC WELDING

Voltage Display: Display voltage setting status.

Current/ Wire Speed Display: Under MIG Mode: display wire speed setting status under no-load and actual current data during welding process. Under MMA Mode: display current setting status.

Abnormal Indicator: Lights up if there is a problem with welder operation.

Current/ Wire Speed Adjustment Knob: Controls the speed that the welding wire feeds out of the MIG Gun or Spool Gun and the output amperage of the Welder.

MIG Gun/ Spool Gun Cable Socket: The MIG Gun and Spool Gun Cables connect here. The wire, welding current, and shielding gas (if performing MIG) feed to the welding gun through here.

Wire Feed Control Socket: Connect the Wire Feed Control Cable here.

Voltage Adjustment Knob: Provides adjustment and control of the welding voltage under MIG mode. It has no effect under MMA mode.

MIG/MMA Selector: Provide selection of MIG or MMA (Stick) welding modes. Selecting MIG position provides for MIG welding function. Selecting MMA position provides for Stick welding function.

2T/4T Selector: Use this to set the Gun Trigger operation to either 2T or 4T mode:

2T (2 touch) mode:

1. Squeeze the trigger to start the welding current
2. Release trigger to stop the welding current.

4T (4 touch) mode:

1. Squeeze trigger to start welding.
2. Release trigger during welding.
3. Squeeze and release trigger to shut welding current off.

Quick Wire Feed Function: While not welding the wire feed will go slow at first. Hold the trigger down for 5 seconds for the machine to enter into wire quick feed mode. The wire speed cannot be adjusted under quick feed mode. Wire speed can only be adjusted when welding with arc.

BASIC WELDING

Interior Controls

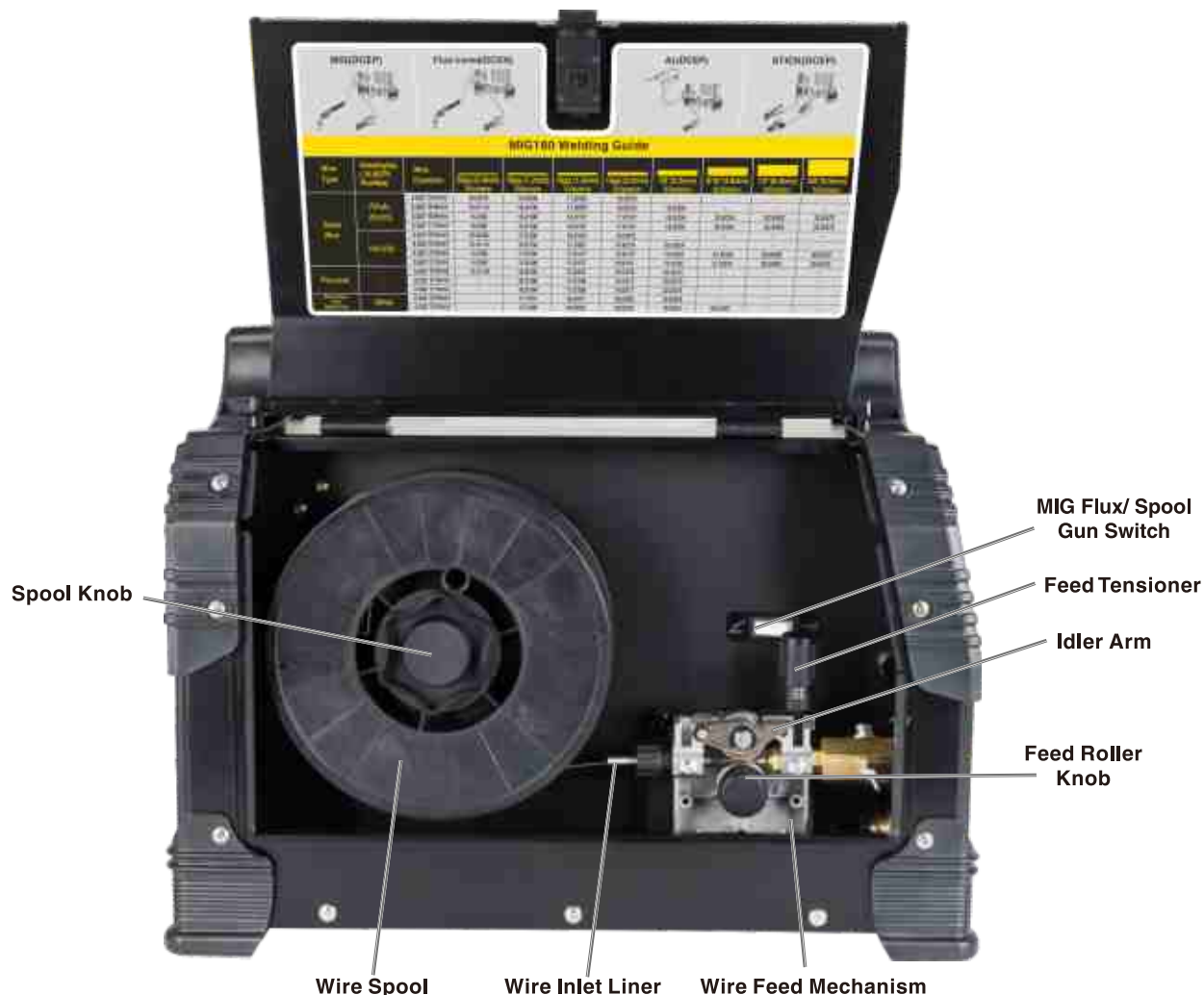

Note: When using an optional Spool Gun (included), disconnect input power to the machine and place the MIG Flux/Spool Gun Switch on the Spool Gun setting. Fully insert gun cable into the socket, plug the 4pin plug into the wire feed control socket. For all other welding, place the MIG FLUX/Spool Gun Switch on the MIG Flux Gun setting.

BASIC WELDING

Back View

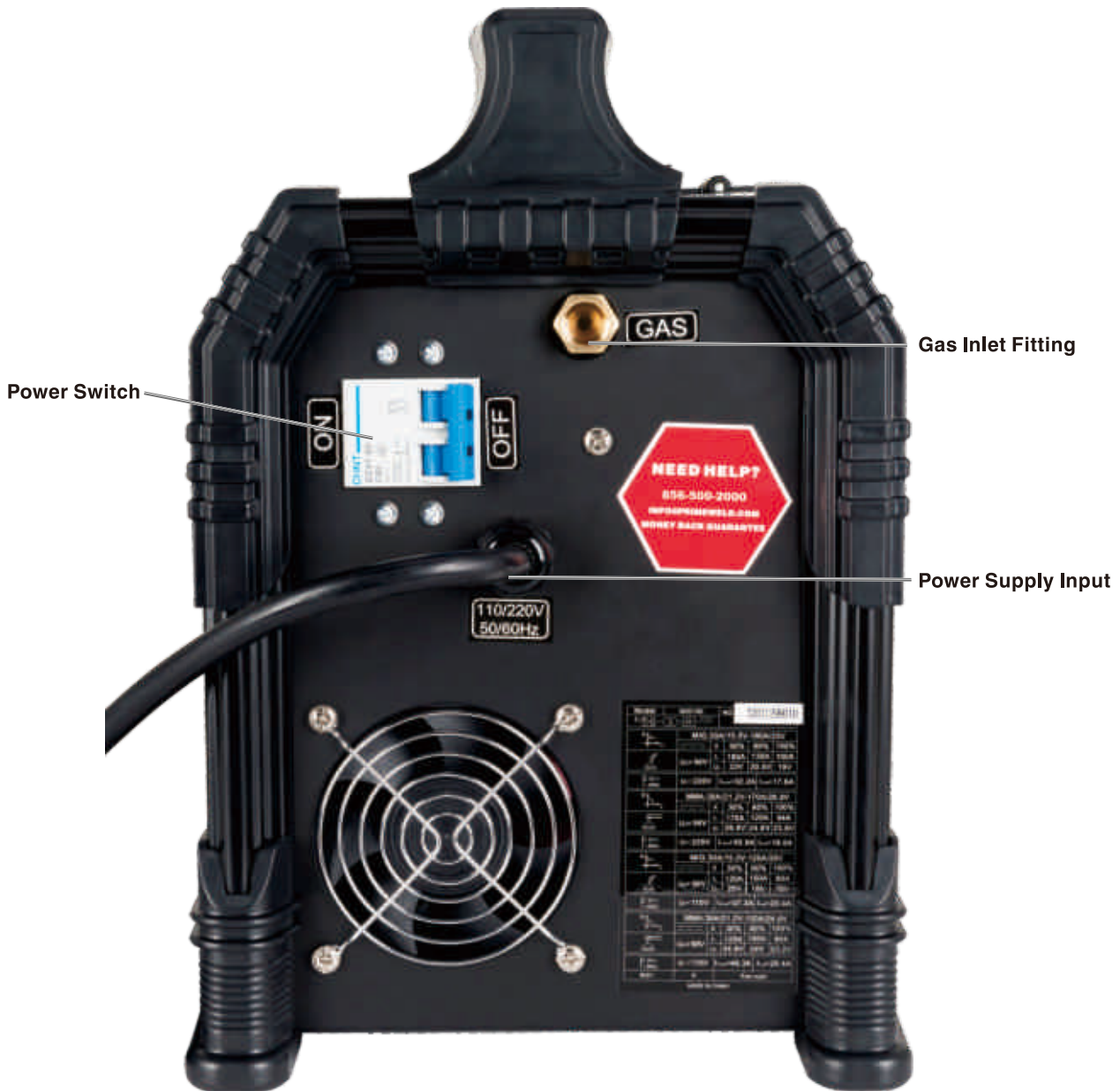

Weld Settings

Refer to the Settings Chart on the inside of the Welder door for Flux-Cored and MIG Weld settings. The chart is only intended to show general guidelines for different wire sizes and for different thicknesses of material. The initial settings used at the beginning of a weld may need to be adjusted after stopping and carefully inspecting the weld. Proper welding takes experience.

BASIC WELDING

Duty Cycle (Duration of Use)

Avoid damage to the Welder by not welding for more than the prescribed duty cycle time. The Duty Cycle defines the number of minutes, within a 10 minute period, during which a given welder can produce a particular welding current without overheating.

For example, a welder with a 30% duty cycle at 180 A welding current must be allowed to rest for at least 7 minutes after every 3 minutes of continuous welding.

Failure to carefully observe any duty cycle limitations can easily over-stress a welder's power generation system contributing to premature welder failure.

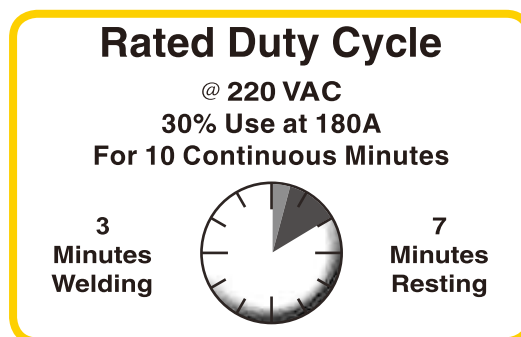
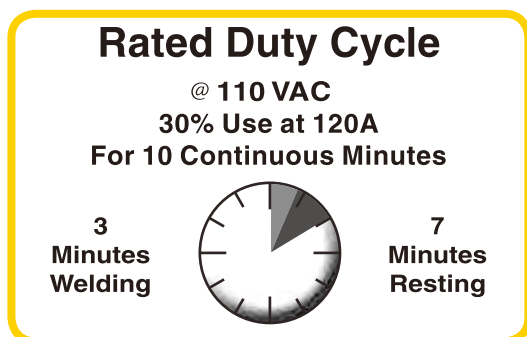

This Welder has an internal thermal protection system to help prevent this sort of over-stress. When the Welder overheats, it automatically shuts down and the Abnormal Indicator lights.

The Welder automatically returns to service after cooling off. Should this occur, rest the MIG Gun on an electrically non-conductive, heat-proof surface, such as a concrete slab, well clear of the ground clamp.

Allow the Welder to cool with the Power Switch on, so that the internal Fan will help cool the Welder.



BASIC WELDING

When the Abnormal Indicator is no longer lit and the Welder can be used again, use shorter welding periods and longer rest periods to prevent needless wear.



Setting Up The Weld

- 1** Make practice welds on pieces of scrap the same thickness as your intended workpiece to practice technique before welding anything of value. Clean the weld surfaces thoroughly with a wire brush or angle grinder; there must be no rust, paint, oil, or other materials on the weld surfaces, only bare metal.
- 2** Use clamps (not included) to hold the workpieces in position so that you can concentrate on proper welding technique. The distance (if any) between the two workpieces must be controlled properly to allow the weld to hold both sides securely while allowing the weld to penetrate fully into the joint. The edges of thicker workpieces may need to be chamfered (or beveled) to allow proper weld penetration.

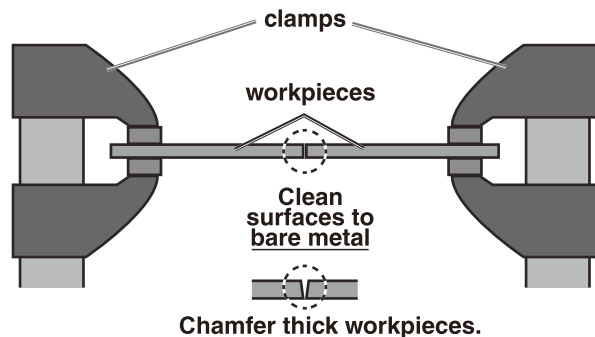

BASIC WELDING

Notice: When welding equipment on a vehicle, disconnect the vehicle battery power from both the positive connection and the ground before welding. This prevents damage to some vehicle electrical systems and electronics due to the high voltage and high frequency bursts common in welding.

- 3 Clamp Ground Cable to bare metal on the workpiece near the weld area, or to metal work bench where the workpiece is clamped.



- 4 Set the Wire Speed, Voltage Knobs to the desired settings. Refer to the Settings Chart on the inside of the Welder door.

Note: The initial settings may need to be adjusted after stopping and carefully inspecting the weld. Proper welding takes experience.

DANGER! TO PREVENT DEATH FROM ASPHYXIATION:

Do not open gas without proper ventilation. Fix gas leaks immediately. Shielding gas can displace air and cause rapid loss of consciousness and death. **Shielding gas without carbon dioxide can be even more hazardous because asphyxiation can start without feeling shortness of breath.**



BASIC WELDING

5 Gas shielded, solid-core wire only:

- A: Open gas cylinder valve all the way.
- B: Set Flow Gauge to 20-30 cubic ft per hour(CFH), (10-14L/min).

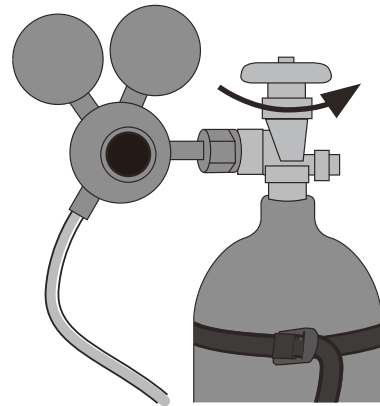

6 Turn the Power Switch off and do not touch the Gun's Trigger and before connecting Power Cord: If using 110VAC, connect the included adapter to the end of the Power Cord. If using 220VAC, do not use the adapter. Plug the Power Cord into a properly grounded and rated receptacle that matches the plug and turn the Power Switch ON.

Note: The circuit must be equipped with delayed action-type circuit breaker or fuses.

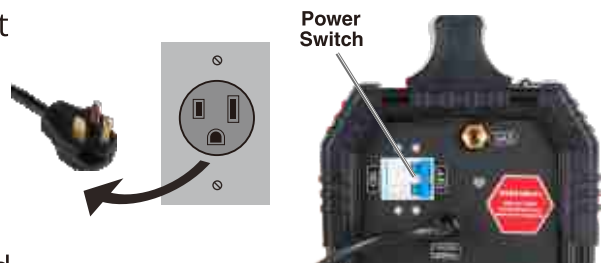

220V to 110V Plug Adapter

7 Set MIG Gun down on nonconductive, nonflammable surface away from any grounded objects. Turn the Power Switch ON.



BASIC WELDING TECHNIQUE

1 Press (and hold) Trigger and contact the area to be welded with electrode wire to ignite arc.

2 For a narrow weld, you can usually draw the wire in a steady straight line. This is called a **stringer bead**.

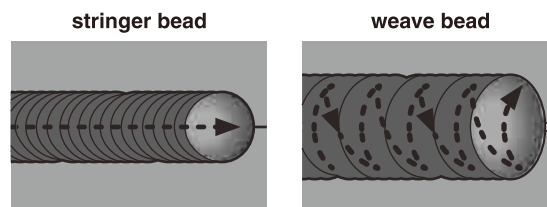

For a wider weld, draw the wire back and forth across the joint. This is called a **weave bead** and takes practice to perform properly.

3 Direct the welding wire straight into the joint. This gives an angle of 90° (straight up and down) for butt (end to end) welds, and an angle of 45° for fillet (T-shaped) welds.

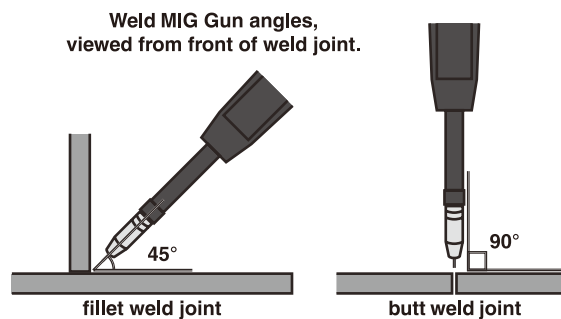

4 For MIG welding using solid wire and shielding gas, the end of the MIG Gun should be tilted so that wire is angled anywhere in-between straight on and 15° away from the direction you are welding. The amount of tilt is called the push angle.

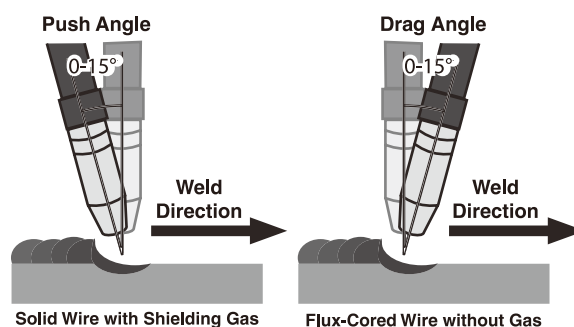

5 When using flux-cored wire without shielding gas, the end of the MIG Gun should be tilted so that wire is angled anywhere in-between straight on and 15° in the direction you are welding. The amount of tilt is called the drag angle.

BASIC WELDING TECHNIQUE

- 6** The Contact Tip should remain within 1/2" of the work surface. This distance is called CTWD - Contact Tip to Work Distance.

Note: If Welder is used too long, the Abnormal Indicator lights up and the unit automatically shuts down. The Welder automatically returns to service after cooling off. Should this occur, rest the MIG Gun on an electrically nonconductive, heat-proof surface, such as a concrete slab, away from the ground clamp.

Allow the Welder to cool with the power Switch on, so that the internal Fan will help cool the Welder.

When the Abnormal Indicator is no longer lit and the Welder can be used again, use shorter welding periods and longer rest periods to help prevent needless wear.

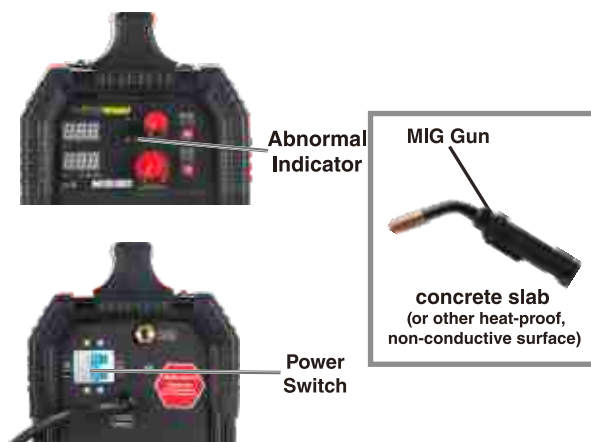
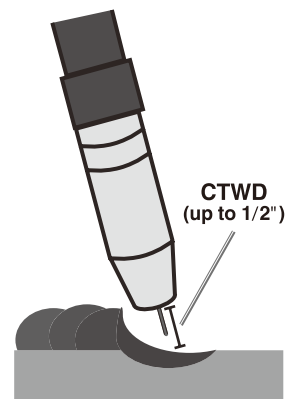

- 7** After welding the test weld on a piece of scrap for a few seconds, stop, and check your progress. Clean, then compare your weld's appearance with the diagrams and descriptions in the **Welding tips** section starting on the next page. After making any necessary adjustments, continue to weld **while carefully following the DUTY CYCLE guidelines as explained on page 28.**

After practice welding for a few seconds, STOP and examine your weld using the guidelines starting on the next page.

CAUTION! Weld will be hot, do not touch.

BASIC WELDING TECHNIQUE

8 When welding is complete, set the MIG Gun down on a heat-proof, electrically non-conductive surface. Turn the Power Switch OFF.

9 Allow Welder to cool down, then unplug the Power Cord.

10 Remove Ground Clamp from workpiece or table and disconnect MIG Gun.

11 Respool wire by clipping wire, removing gas nozzle/contact tip on MIG Gun, releasing Idler Arm on Wire Feed mechanism, and rotating the Wire Spool counterclockwise. Be sure to securely hold wire as it is being respooled because the end of wire has a tendency to quickly unravel once it clears the wire feeder.

12 **MIG ONLY:** Close shielding gas cylinder valve securely. Remove Regulator and replace cap. Disconnect Gas Hose from Welder. Store and secure gas cylinder.

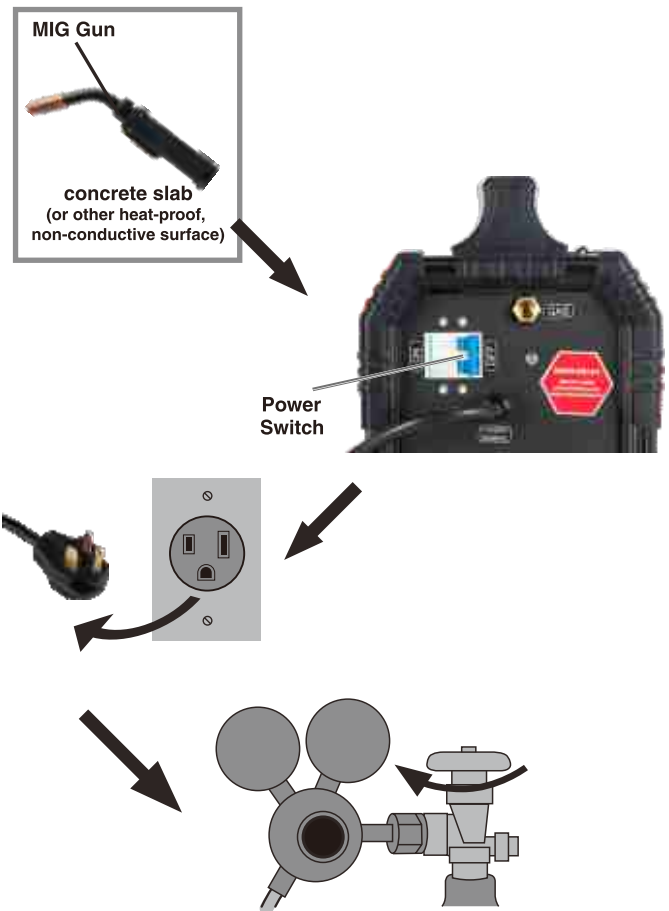

WELDING TIPS

A good way to test welding technique is to examine a weld's appearance after it has cooled and the slag has been removed. Then, better welding can be learned by adjusting your weld technique to remedy any problems found.

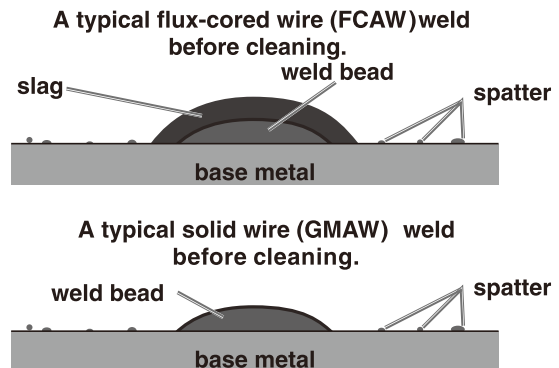

Cleaning the Weld

⚠️ WARNING



TO PREVENT SERIOUS INJURY:
Continue to wear ANSI approved safety goggles and protective wear when cleaning a weld.
Sparks or chips may fly when cleaning.

- 9 A weld from flux-cored wire will be covered by slag. Use a chipping hammer to knock this off.
Be careful not to damage the weld or base material.
- 10 Use a wire brush to further clean the weld or use an angle grinder (sold separately) to shape the weld.

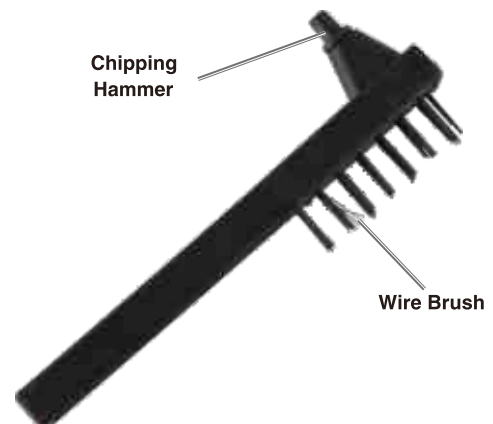

WELDING TIPS

Strike Test

A test weld on a **PIECE OF SCRAP** can be tested by using the following procedure. **WEAR ANSI-APPROVED SAFETY GOGGLES DURING THIS PROCEDURE.**

WARNING! This test **WILL** damage the weld it is performed on. This test is **ONLY** an indicator of weld technique and is not intended to test working welds.

- 1 After two scraps have been welded together and the weld has cooled, clamp one scrap in a sturdy vise.
- 2 Stay clear from underneath while you strike the opposite scrap with a heavy hammer, preferably a dead-blow hammer.
- 3 A **GOOD WELD** will deform but not break, as shown on top. A **POOR WELD** will be brittle and snap at the weld, as shown on bottom.

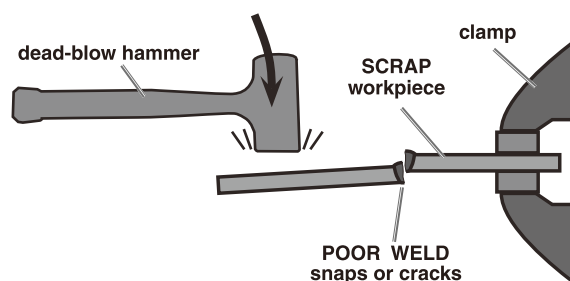
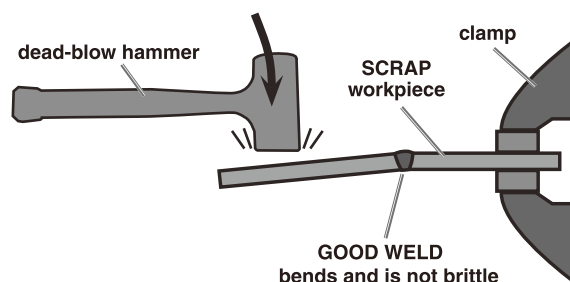

WELD DIAGNOSIS

Workpiece Heat control / Weld penetration

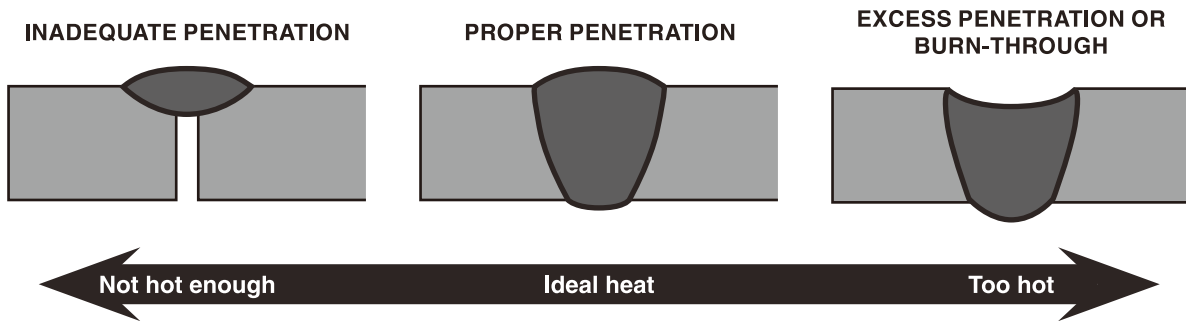

How to increase workpiece heat and increase penetration:
(to weld THICKER workpieces properly)

- a. Increase weld current
- b. Decrease travel speed
- c. Use faster wire feed
- d. Use shorter CTWD

How to reduce workpiece heat and limit penetration:
(to weld THINNER workpieces properly)

- a. Decrease weld current
- b. Increase travel speed
- c. Use slower wire feed
- d. Use longer CTWD

Example Weld Diagrams

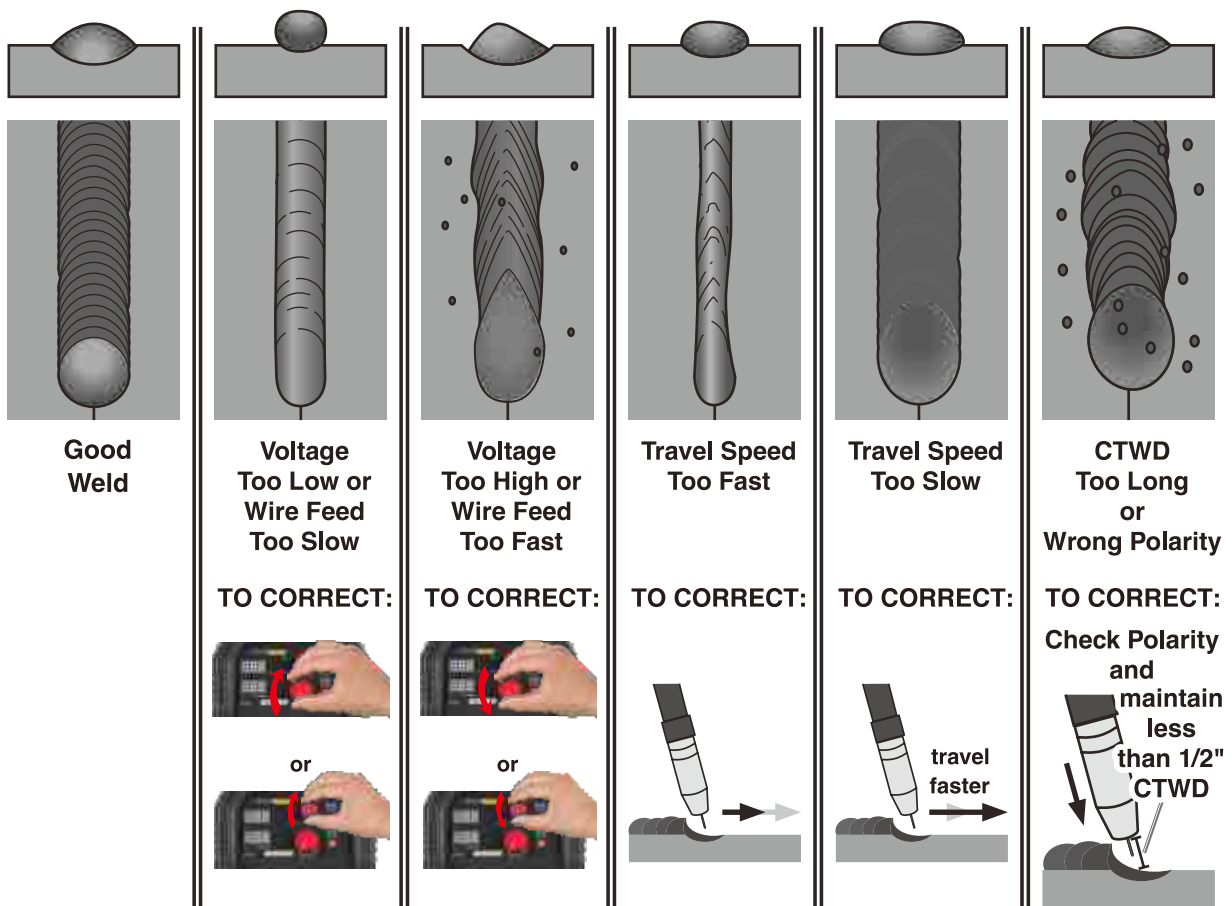

WELD PROBLEMS

Penetration(Workpiece Heat Control)

EXCESS PENETRATION OR BURN-THROUGH

Weld droops on top and underneath, or falls through entirely, making a hole.

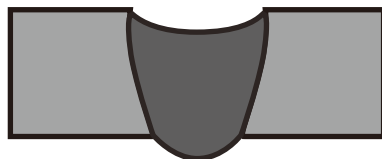

PROPER PENETRATION

Weld is visible underneath and bulges slightly on top.

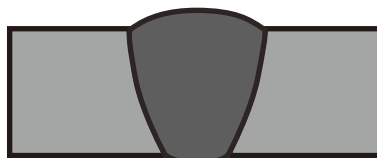

PROFILE VIEWS

INADEQUATE PENETRATION

Weld does not penetrate the joint fully, just on the surface.

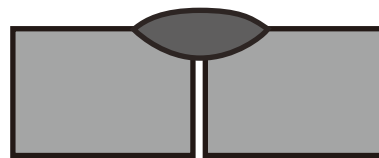

POSSIBLE CAUSES AND SOLUTIONS

1. **Workpiece overheating:**
Reduce wire feed speed.
Decrease weld current.
2. **Travel speed too slow:**
Increase travel speed and ensure that travelspeed is kept steady.
3. **Excessive material at weld:**
Reduce wire feed speed.

POSSIBLE CAUSES AND SOLUTIONS

1. **Incorrect welding technique:**
Maintain 1/2" or less CTWD.
Keep arc on leading edge of weld puddle. Hold MIG Gun at proper angles.
2. **Insufficient weld heat:**
Reduce travel speed.
Increase weld current.
3. **Workpieces too thick/close:**
Bevel thick workpieces, allow slight gap, and weld in several passes.
4. **Insufficient weld material:**
Increase wire feed speed.

WELD PROBLEMS

Bend at Joint

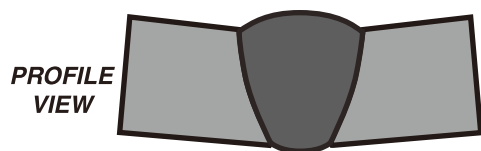

POSSIBLE CAUSES AND SOLUTIONS

1. **Improper clamping:**
Clamp workpieces securely.
Make tack welds to hold workpieces.
2. **Excessive heat:**
Weld a small portion and allow to cool before proceeding.
Increase travel speed. Reduce wire feed speed.

Coat of Slag Over Weld



Slag is a necessary part of a flux cored wire weld. It shields the weld from impurities. Clean off the slag with a Chipping Hammer and Wire Brush after welding.

Gas-shielded MIG welds are protected by the shielding gas and do not need slag to protect them.

Weld Not Adhering Properly

Gaps present between weld and previous bead or between weld and workpiece. See areas below.

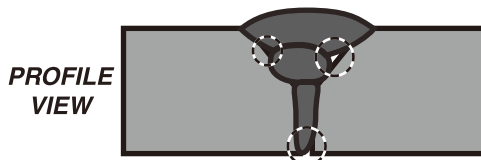

POSSIBLE CAUSES AND SOLUTIONS

1. **Incorrect welding technique:**
Place stringer bead at correct place in joint. Adjust workpiece position or weld angle to permit proper welding to bottom of piece. Pause briefly at sides during weave bead. Keep arc on leading edge of weld puddle. Hold MIG Gun at proper angles.
2. **Insufficient weld material:**
Increase current.
Increase wire feed speed.
3. **Dirty workpiece:**
Clean workpiece down to bare metal.
4. **Insufficient weld material:**
Increase wire feed speed.
5. **Workpiece gap too narrow:**
Widen groove or increase bevel.

WELD PROBLEMS

Porosity

Small cavities or holes in the bead.

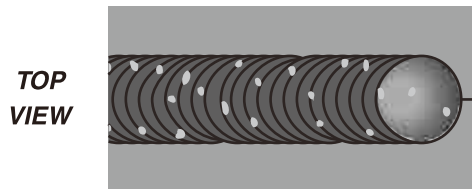

POSSIBLE CAUSES AND SOLUTIONS

1. **Incorrect polarity:**
Check that polarity is set correctly for type of welding.
2. **Insufficient shielding gas (MIG only):**
Increase flow of gas. Clean nozzle. Maintain proper CTWD.
3. **Incorrect shielding gas (MIG only):**
Use shielding gas recommended by wire supplier.
4. **Dirty workpiece or welding wire:**
Clean workpiece down to bare metal. Make certain that wire is clean and free from oil, coatings, and other residues.
5. **Inconsistent travel speed:**
Maintain steady travel speed.
6. **CTWD too long:**
Reduce CTWD.

Excessive Spatter

Fine spatter is normal.
Spatter that is grainy and large is a problem.

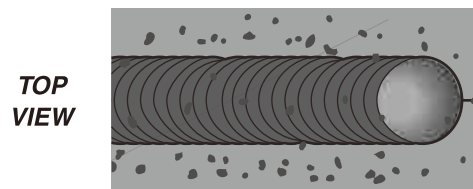

POSSIBLE CAUSES AND SOLUTIONS

1. **Dirty workpiece or welding wire:** Clean workpiece down to bare metal. Make certain that wire is clean and free from oil, coatings, and other residues.
2. **Incorrect polarity:**
Check that polarity is set correctly for type of welding.
3. **Insufficient shielding gas (MIG only):** Increase flow of gas. Clean nozzle. Maintain proper CTWD.
4. **Wire feeding too fast:**
Reduce wire feed speed.
5. **CTWD too long:**
Reduce CTWD.

WELD PROBLEMS

Crooked/Wavy Bead

TOP
VIEW

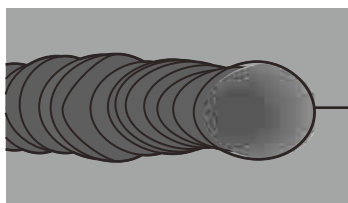

POSSIBLE CAUSES AND SOLUTIONS

1. **Inaccurate welding:**
Use two hands or rest hand on steady surface.
2. **Inconsistent travel speed:**
Maintain steady travel speed.
3. **CTWD too long:**
Reduce CTWD.

Burn-Through

Base material melts away,
leaving a hole in the weld.

TOP
VIEW

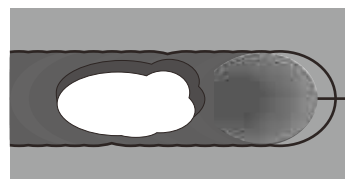

POSSIBLE CAUSES AND SOLUTIONS

1. **Workpiece overheating:**
Reduce current and/or wire feed speed.
2. **Travel speed too slow:**
Increase travel speed and ensure that travel speed is kept steady.
3. **Excessive material at weld:**
Reduce wire feed speed.

INSTALLATION SET-UP FOR SMAW (STICK) WELDING

INSTALLATION SET UP FOR SMAW (STICK) WELDING

- 1 Turn the power source on and select the MMA function with the MIG/MMA selector switch.
- 2 Connection of Output Cables

Two weld output receptacles are available on this welding machine. For Stick welding the electrode holder is connected to the positive receptacle, while the ground lead (work piece) is connected to the negative receptacle, this is known as DC+ polarity. However various electrodes require a different polarity for optimum results and careful attention should be paid to the polarity, refer to the electrode manufacturer's information for the correct polarity

DC+ Electrode connected to ⊕ output receptacle.

DC- Electrode connected to ⊖ output receptacle.



OPERATION FOR SMAW (STICK) WELDING

- 3 Set the welding current relevant to the electrode type and size being used as recommended by the electrode manufacturer.
- 4 Place the electrode into the electrode holder and clamp tight.
- 5 Scratch the electrode against the work piece to create an arc and hold the electrode steady to maintain the arc.
- 6 Hold the electrode slightly above the work piece to maintain the arc while traveling at an even speed to create an even weld deposition.
- 7 To finish the weld, break the arc by quickly snapping the electrode away from the work piece.
- 8 Wait for the weld to cool and carefully chip away the slag to reveal the weld metal underneath.



SMAW (STICK) WELDING GENERAL DESCRIPTION

One of the most common types of arc welding is shielded metal arc welding (SMAW) or stick welding. An electric current is used to strike an arc between the base material and a consumable electrode rod or 'stick'. The electrode rod is made of a material that is compatible with the base material being welded and is covered with a flux that gives off gaseous vapors that serve as a shielding gas and provide a layer of slag, both of which protect the weld area from atmospheric contamination. The electrode core itself acts as filler material. The residue from the flux that forms a slag covering over the weld metal must be chipped away after welding.

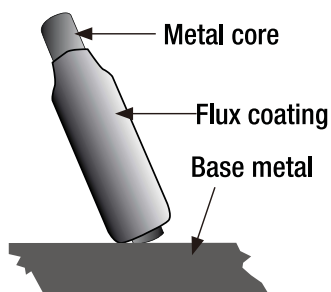
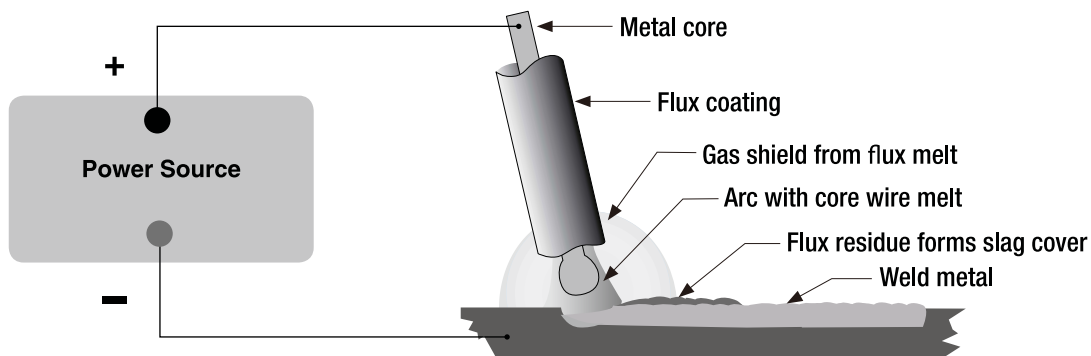

The arc is initiated by momentarily touching the electrode to the base metal.

The heat of the arc melts the surface of the base metal to form a molten pool at the end of the electrode.

The melted electrode metal is transferred across the arc into the molten pool and becomes the deposited weld metal.

The deposit is covered and protected by a slag which comes from the electrode coating.

The arc and the immediate area are enveloped by an atmosphere of protective gas.

SMAW (stick) electrodes have a solid metal core and a flux coating. These electrodes are identified by the metal core diameter and by a series of letters and numbers. The letters and numbers identify the metal alloy and the intended use of the electrode.

SMAW (STICK) WELDING GENERAL DESCRIPTION

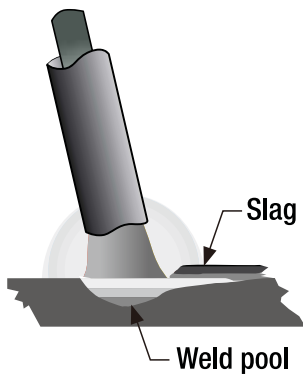
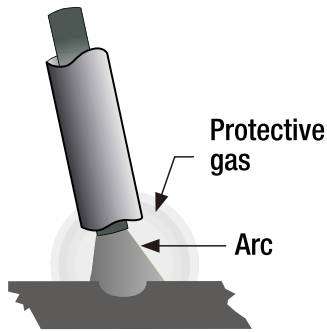

The metal core works as conductor of the current that maintains the arc. The metal core melts and is deposited into the weld pool.

The covering on a shielded metal arc welding electrode is called flux. The flux on the electrode performs many different functions.

These include:

Producing a protective gas around the weld area

Providing fluxing elements and deoxidizers

Creating a protective slag coating over the weld as it cools

Establishing arc characteristics

Adding alloying elements.

Covered electrodes serve many purposes in addition to adding filler metal to the molten pool. These additional functions are provided mainly by the covering on the electrode.

SMAW (STICK) WELDING FUNDAMENTALS

ELECTRODE SELECTION

As a general rule, the selection of an electrode is straight forward, in that it is only a matter of selecting an electrode of similar composition to the parent metal. However, for some metals there is a choice of several electrodes, each of which has particular properties to suit specific classes of work. It is recommended that you consult your welding equipment supplier for the correct selection of electrode.

ELECTRODE SIZE

Average Thickness of Material		Maximum Recommended Electrode Diameter	
0.03 – 0.07 inches	0.75 – 2mm	3/32 inch	2.4mm
0.07 – 0.19 inches	2 – 4.8mm	1/8 inch	3.2mm
0.19 – 0.39 inches	4.8–10mm	5/32 inch	4 mm

ELECTRODE SIZE

The size of the electrode generally depends on the thickness of the section being welded, and the thicker the section the larger the electrode required. The table gives the maximum size of electrodes that may be used for various thicknesses of section based on using a general purpose type 6013 electrode.

WELDING CURRENT (AMPERAGE)

Electrode Size		Current Range
3/32 inch	2.4mm	60 – 100 amps
1/8 inch	3.2mm	100 – 130 amps
5/32 inch	4 mm	130 – 170 amps

WELDING CURRENT (AMPERAGE)

Correct current selection for a particular job is an important factor in stick welding. With the current set too low, difficulty can be experienced in striking and maintaining a stable arc. The electrode tends to stick to the work, penetration is poor and beads with a distinct rounded profile will be deposited. Too high current is accompanied by overheating of the electrode resulting in undercut and burning through of the base metal and producing excessive spatter. Normal current for a particular job may be considered as the maximum which can be used without burning through the work, over-heating the electrode or producing a rough spattered surface. The table shows current ranges generally recommended for a general purpose type 6013 electrode.

General rule of thumb for down hand welding is to have an arc length no greater than the diameter of the electrode.

SMAW (STICK) WELDING FUNDAMENTALS

ARC LENGTH

To strike the arc, the electrode should be gently scraped on the work until the arc is established. There is a simple rule for the proper arc length; it should be the shortest arc that gives a good surface to the weld. An arc too long reduces penetration, produces spatter and gives a rough surface finish to the weld. An excessively short arc will cause sticking of the electrode and result in poor quality welds. General rule of thumb for down hand welding is to have an arc length no greater than the diameter of the electrode.

ELECTRODE ANGLE

The angle that the electrode makes with the work is important to ensure a smooth, even transfer of metal. When welding in down hand, fillet, horizontal or overhead the angle of the electrode is generally between 5 and 15 degrees towards the direction of travel. When vertical up welding the angle of the electrode should be between 80 and 90 degrees to the work piece.

Excessive travel speeds lead to poor fusion, lack of penetration, etc., while too slow a rate of travel will frequently lead to arc instability, slag inclusions and poor mechanical properties.

TRAVEL SPEED

The electrode should be moved along in the direction of the joint being welded at a speed that will give the size of run required. At the same time, the electrode is fed downwards to keep the correct arc length at all times. Excessive travel speeds lead to poor fusion, lack of penetration, etc., while too slow a rate of travel will frequently lead to arc instability, slag inclusions and poor mechanical properties.

MATERIAL AND JOINT PREPARATION

The material to be welded should be clean and free of any moisture, paint, oil, grease, mill scale, rust or any other material that will hinder the arc and contaminate the weld material. Joint preparation will depend on the method used, including sawing, punching, shearing, machining, flame cutting and others. In all cases edges should be clean and free of any contaminants. The type of joint will be determined by the chosen application.

MAINTENANCE

WARNING



TO PREVENT SERIOUS INJURY, FIRE AND BURNS: Unplug the Welder, rest the MIG Gun on a heat-proof, electrically non-conductive surface, and allow all parts of the Welder to cool thoroughly before service.

1. **BEFORE EACH USE**, inspect the general condition of the Welder. Check for:
 - loose hardware
 - misalignment or binding of moving parts
 - damaged cord / electrical wiring
 - frayed or damaged cables
 - cracked or broken parts
 - any other condition that may affect its safe operation.
2. Periodically, have a qualified technician remove the Rear Panel and use compressed air to blow out all dust from the interior.
3. Store in a clean and dry location.
4. **For optimal weld quality, clean and inspect the contact tip and nozzle before each use, as explained below.**

MAINTENANCE

Nozzle and Contact Tip Inspection and Cleaning

1. Make sure that the entire Mig gun is completely cool and that the power cord is unplugged from the electrical outlet before proceeding.
2. Pull the Nozzle to remove it.
3. Scrub the interior of the Nozzle clean with a wire brush.
4. Examine the end of the Nozzle. The end should be flat and even. If the end is uneven, hipped, melted, cracked, or otherwise damaged, the Nozzle will adversely effect the weld and should be replaced.
5. Unscrew the Contact Tip counterclockwise and slide it off the welding wire to remove.
6. Scrub the outside of the Tip clean with a wire brush. Clean out the inside of the tip with a tip cleaner (sold separately). Check that the Tip is the proper type for the wire size used.
7. Examine the shape of the hole at the end of the Contact Tip. It should be an even circle; it should not be oblong or have any bulges in it.
8. If any problems are noted, replace the Contact Tip. Select a new Tip of the correct size for the welding wire used.
9. Reinstall the Tip and securely reinstall the Nozzle as well.

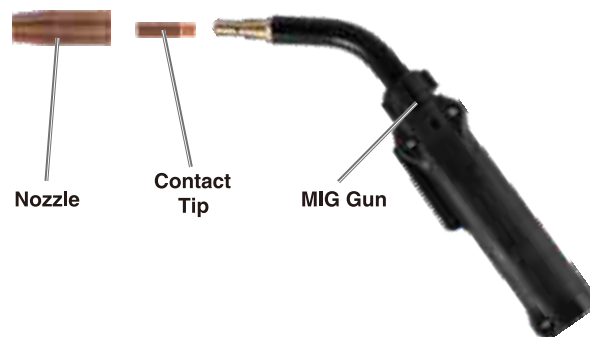

MAINTENANCE

Troubleshooting

IMPORTANT!

Be CERTAIN to shut off the Welder, disconnect it from power, and discharge the MIG Gun to ground before adjusting, cleaning, or repairing the unit.

Problem	Possible Causes	Likely Solutions
Welding arc not stable	<ol style="list-style-type: none"> 1. Insufficient wire feed tension. 2. Incorrect wire feed roller size. 3. Damaged MIG Gun, cable, or liner assembly. 4. Feed Tensioner is too tight. 	<ol style="list-style-type: none"> 1. Increase wire feed tension properly. Follow step 25 on page 20. 2. Flip roller to correct size, follow the Feed Roller instructions on page 15. 3. Have a qualified technician inspect these parts and replace as necessary. 4. Loosen Feed Tensioner so it applies on enough pressure to prevent continued spinning after the Gun Trigger is released.
Wire creates a bird's nest during operation	<ol style="list-style-type: none"> 1. Excess wire feed tension. 2. Incorrect Contacttip size. 3. MIG Gun Cable Connector not fully inserted into Wire Feed mechanism. 4. Damaged liner. 	<ol style="list-style-type: none"> 1. Adjust Wire feed pressure properly Follow step 25 on page 20. 2. Replace with the proper tip for wire used. 3. Insert Gun Cable Connector proper Follow steps 13 and 14 on page 17. 4. Have a qualified technician inspect and repair/replace as necessary.
Wire stops during welding	<ol style="list-style-type: none"> 1. Gun cable is severely bent and Wire Feed mechanism cannot feed wire. 2. Gun liner is Clogged or worn . 3. Gun liner is too small for welding wire being used. 4. Wire is tangled on the spool. 5. Wire is not making contact with Feed Rollers. 6. Feed Roller is not making enough contact with wire or is crushing flux-cored Wire. 	<ol style="list-style-type: none"> 1. Straighten Gun cable. 2. Check gun liner for obstruction. Replace if necessary. 3. Check that gun liner is correct size for wire. 4. Check wire for cross winding or tangled spool. 5. Check Feed Rollers and ensure correct groove for wire diameter is being used. 6. Check Feed Tensioner and ensure it is set proper.
 Follow all safety precautions whenever diagnosing or servicing the equipment.		

MAINTENANCE

Troubleshooting

IMPORTANT!

Be CERTAIN to shut off the Welder, disconnect it from power, and discharge the MIG Gun to ground before adjusting, cleaning, or repairing the unit.

Problem	Possible Causes	Likely Solutions
Welding arc not stable	<ol style="list-style-type: none"> 1. Wire not feeding properly. 2. Incorrect Contact Tip or liner size or excessive wear. 3. Incorrect wire feed speed. 4. Loose MIG Gun cable or ground Cable. 5. Damaged MIG Gun or loose connection within Gun. 6. Incorrect polarity for process being run. 7. Gas coverage may be insufficient or too high. 8. Poor connection with workpiece. 	<ol style="list-style-type: none"> 1. See first Troubleshooting section above. 2. Replace with the proper tip or liner size for wire used. 3. Adjust wire feed speed to achieve a more stable arc. 4. Check to ensure that all connections are tight. 5. Have a qualified technician inspect and repair/replace as necessary. 6. Ensure polarity is correct for operation: DCEP for MIG and DCE N for Flux-cored. 7. Ensure gas flow rate is set according to Settings Chart. Make sure MIG Gun Cable Connector is fully inserted into Wire Feed mechanism with no O-rings exposed. 8. Check the ground clamp connection to the workpiece and machine. Ensure the MIG Gun is properly secured.
Weak arc strength	<ol style="list-style-type: none"> 1. Incorrect line voltage. 2. Improper gauge or length of cord. 3. Not enough current. 	<ol style="list-style-type: none"> 1. Check the line voltage and, if insufficient, have a licensed electrician remedy the situation. 2. Do not use an extension cord on this Welder. Use only one of the supplied power cords for this Welder or an identical replacement cord. 3. Switch current to proper setting for metal thickness.
When switched on Power Indicator lights but Welder does not function	<ol style="list-style-type: none"> 1. Faulty or improperly connected Trigger. 2. Machine is in the incorrect mode. 	<ol style="list-style-type: none"> 1. Ensure the gun connection is properly seated on machine. Qualified technician must check and secure/replace Trigger. 2. Ensure the MIG Flux/Spool Gun switch located above the Wire Feed mechanism is switched to the correct process. Refer to Interior Controls on page 26.
Power ON Indicator does not light when switched on	<ol style="list-style-type: none"> 1. Unit is not connected to outlet properly. 2. Outlet is unpowered. 3. Circuit supplies insufficient input voltage or amperage. 4. Plug does not have correct rating. 5. Input Power Cord is not seated properly. 	<ol style="list-style-type: none"> 1. Verify the voltage at the outlet and the connection to the outlet. 2. Check circuit breaker/GFCI devices; if any are tripped, determine and remedy cause before resetting. 3. Verify that the circuit is designed to supply the required input voltage and amperage as detailed on the Specifications table. If the Voltage Input/Thermal Overload Indicator is illuminated on machine, check the input voltage to ensure it is within specified range. 4. Make sure installed plug is correct rating. See Specifications on page 11. 5. Ensure the input Power Cord is fully secured.
 Follow all safety precautions whenever diagnosing or servicing the equipment.		

MAINTENANCE

Troubleshooting (continued)

IMPORTANT!

Be CERTAIN to shut off the Welder, disconnect it from power, and discharge the MIG Gun to ground before adjusting, cleaning, or repairing the unit.

Problem	Possible Causes	Likely Solutions
Wire feeds, but arc does not ignite	<ol style="list-style-type: none"> 1. Improper ground connection. 2. Improperly sized Contact Tip. 3. Excessively worn Contact Tip. 4. Dirty Contact Tip. 	<ol style="list-style-type: none"> 1. Make certain that the workpiece is contacted properly by the Ground Clamp and that the workpiece is properly cleaned near the ground clamp and the welding location. 2. Verify that Contact Tip is the proper size for welding wire. If needed, replace Contact Tip with proper size and type. 3. Check that the hole in the tip is not deformed or enlarged. If needed, replace Contact Tip with proper size and type. 4. Properly clean Contact Tip.
Porosity in the weld metal	<ol style="list-style-type: none"> 1. Shielding gas cylinder is empty. 2. Not enough or too much shielding gas. 3. Dirty workpiece. 4. Gun is being used too far away from Workpiece. 5. Polarity is incorrect for the application. 6. Dirty welding wire is introducing contamination into the weld. 	<ol style="list-style-type: none"> 1. Check gas cylinder and replenish as necessary. 2. Check gas regulator to ensure proper flow. 3. Clean workpiece down to bare metal. 4. Check CTWD (contact tip to work distance) for the proper procedure. 5. Check the polarity and ensure it is DCEP for MIG and DCEN for Flux-cored. 6. Make certain that welding wire is clean and free of rust and residues.
 Follow all safety precautions whenever diagnosing or servicing the equipment.		

PARTS LIST AND DIAGRAM

Parts List

Part	Description	Qty
1	Divider	1
2	MIG Gun Copper Connector Kit	1
3	MIG Gun Cable Socket Fixed Board	1
4	Control Board	1
5	Right Back Iron Part	1
6	Right Back Plastic Part	1
7	Hinge	1
8	Housing	1
9	Right Front Iron Part	1
10	Right Front Plastic Part	1
11	Right Plastic Foot	2
12	Ground Clamp	1
13	MIG Gun	1
14	Right Back Plastic Foot	2
15	Copper Connection 1	1
16	Copper Connection 2	1
17	Wire Feed Power Cable	1
18	Main Control Board	1
19	Power Socket	2
20	Knob	2
21	Grommet	1
22	Digital Panel Board	1
23	4 Pin Control Socket	1
24	Insulated Seat for Control Socket	1
25	Baseboard	1

Part	Description	Qty
26	Left Front Plastic Part	1
27	Left Front Iron Part	1
28	Front Fillet	1
29	Door Panel Decorative Strip	1
30	Door	1
31	Door Latch	1
32	Back Fillet	1
33	Left Back Iron Part	1
34	Left Back Plastic Part	1
35	Cooling Fan	1
36	Fan Cover	1
37	Cable Clip	1
38	Back Grommet	1
39	Solenoid Valve	1
40	Power Cord	1
41	Back Handle Seat	1
42	Circuit Breaker	1
43	Circuit Breaker Bracket	1
44	Handle	1
45	Spool Holder	1
46	Wire Feed	1
47	Front Handle Seat	1
48	MIG/Spool Switch	1
49	Panel Board Protective Cover	1
50	Digital Panel Board	1

