

HILTI

SCM 22-A

English



1 Information about the documentation



1.1 About this documentation

- Read this documentation before initial operation or use. This is a prerequisite for safe, trouble-free handling and use of the product.
- Observe the safety instructions and warnings in this documentation and on the product.
- Always keep the operating instructions with the product and make sure that the operating instructions are with the product when it is given to other persons.

1.2 Explanation of symbols used



1.2.1 Warnings

Warnings alert persons to hazards that may occur when handling or using the product. The following signal words are used in combination with a symbol:

	DANGER! Draws attention to an imminent hazard that will lead to serious personal injury or fatality.
	WARNING! Draws attention to a potential hazard that could lead to serious personal injury or fatality.
	CAUTION! Draws attention to a potentially dangerous situation that could lead to minor personal injury or material damage.



1.2.2 Symbols in the documentation

The following symbols are used in this document:

	Read the operating instructions before use
	Instructions for use and other useful information

1.2.3 Symbols in the illustrations



The following symbols are used in illustrations:

	These numbers refer to the corresponding illustrations found at the beginning of these operating instructions.
3	The numbering reflects the sequence of operations shown in the illustrations and may deviate from the steps described in the text.
	Item reference numbers are used in the overview illustration and refer to the numbers used in the key in the product overview section.
	This symbol is intended to draw special attention to certain points when handling the product.

1.3 Product-dependent symbols

1.3.1 Symbols

The following symbols are used on the product:

n_0	Rated speed under no load
	Direct current (DC)
RPM	Revolutions per minute
	Saw blade

1.4 Product information

Hilti products are designed for professional use and may be operated, serviced and maintained only by trained, authorized personnel. This personnel must be informed of any particular hazards that may be encountered. The product and its ancillary equipment can present hazards if used incorrectly by untrained personnel or if used not in accordance with the intended use.

The type designation and serial number are stated on the rating plate.

- ▶ Write down the serial number in the table below. You will be required to state the product details when contacting Hilti Service or your local Hilti organization to inquire about the product.

Product information

Type:	SCM 22-A
Generation:	01
Serial no.:	

1.5 Declaration of conformity

We declare, on our sole responsibility, that the product described here complies with the applicable directives and standards. A copy of the declaration of conformity can be found at the end of this documentation.

The technical documentation is filed and stored here:

Hilti Entwicklungsgesellschaft mbH | Tool Certification | Hiltistrasse 6 | 86916 Kaufering, Germany

2 Safety

2.1 General power tool safety warnings

⚠ WARNING

Read all safety warnings and all instructions. Failure to follow the warnings and instructions may result in electric shock, fire and/or serious injury.

Save all warnings and instructions for future reference.

Work area safety

- ▶ **Keep work area clean and well lit.** Cluttered or dark areas invite accidents.
- ▶ **Do not operate power tools in explosive atmospheres, such as in the presence of flammable liquids, gases or dust.** Power tools create sparks which may ignite the dust or fumes.
- ▶ **Keep children and bystanders away while operating a power tool.** Distractions can cause you to lose control.

Electrical safety

- ▶ **Power tool plugs must match the outlet. Never modify the plug in any way. Do not use any adapter plugs with earthed (grounded) power tools.** Unmodified plugs and matching outlets will reduce risk of electric shock.
- ▶ **Avoid body contact with earthed or grounded surfaces, such as pipes, radiators, ranges and refrigerators.** There is an increased risk of electric shock if your body is earthed or grounded.
- ▶ **Do not expose power tools to rain or wet conditions.** Water entering a power tool will increase the risk of electric shock.
- ▶ **Do not abuse the cord. Never use the cord for carrying, pulling or unplugging the power tool. Keep cord away from heat, oil, sharp edges or moving parts.** Damaged or entangled cords increase the risk of electric shock.
- ▶ **When operating a power tool outdoors, use an extension cord suitable for outdoor use.** Use of a cord suitable for outdoor use reduces the risk of electric shock.
- ▶ **If operating a power tool in a damp location is unavoidable, use a residual current device (RCD) protected supply.** Use of an RCD reduces the risk of electric shock.

Personal safety

- ▶ **Stay alert, watch what you are doing and use common sense when operating a power tool. Do not use a power tool while you are tired or under the influence of drugs, alcohol or medication.** A moment of inattention while operating power tools may result in serious personal injury.
- ▶ **Use personal protective equipment. Always wear eye protection.** Protective equipment such as dust mask, non-skid safety shoes, hard hat, or hearing protection used for appropriate conditions will reduce personal injuries.
- ▶ **Prevent unintentional starting. Ensure the switch is in the off-position before connecting to battery pack, picking up or carrying the tool.** Carrying power tools with your finger on the switch or energising power tools that have the switch on invites accidents.
- ▶ **Remove any adjusting key or wrench before turning the power tool on.** A wrench or a key left attached to a rotating part of the power tool may result in personal injury.
- ▶ **Do not overreach. Keep proper footing and balance at all times.** This enables better control of the power tool in unexpected situations.

- ▶ **Dress properly. Do not wear loose clothing or jewellery. Keep your hair, clothing and gloves away from moving parts.** Loose clothes, jewellery or long hair can be caught in moving parts.
- ▶ **If devices are provided for the connection of dust extraction and collection facilities, ensure these are connected and properly used.** Use of dust collection can reduce dust-related hazards.

Power tool use and care

- ▶ Do not force the power tool. Use the correct power tool for your application. The correct power tool will do the job better and safer at the rate for which it was designed.
- ▶ **Do not use the power tool if the switch does not turn it on and off.** Any power tool that cannot be controlled with the switch is dangerous and must be repaired.
- ▶ **Disconnect the battery pack from the power tool before making any adjustments, changing accessories, or storing power tools.** Such preventive safety measures reduce the risk of starting the power tool accidentally.
- ▶ **Store idle power tools out of the reach of children and do not allow persons unfamiliar with the power tool or these instructions to operate the power tool.** Power tools are dangerous in the hands of untrained users.
- ▶ **Maintain power tools. Check for misalignment or binding of moving parts, breakage of parts and any other condition that may affect the power tool's operation. If damaged, have the power tool repaired before use.** Many accidents are caused by poorly maintained power tools.
- ▶ **Keep cutting tools sharp and clean.** Properly maintained cutting tools with sharp cutting edges are less likely to bind and are easier to control.
- ▶ **Use the power tool, accessories and tool bits etc. in accordance with these instructions, taking into account the working conditions and the work to be performed.** Use of the power tool for operations different from those intended could result in a hazardous situation.

Battery tool use and care

- ▶ **Recharge only with the charger specified by the manufacturer.** A charger that is suitable for one type of battery pack may create a risk of fire when used with another battery pack.
- ▶ **Use power tools only with specifically designated battery packs.** Use of any other battery packs may create a risk of injury and fire.
- ▶ **When battery pack is not in use, keep it away from other metal objects, like paper clips, coins, keys, nails, screws or other small metal objects, that can make a connection from one terminal to another.** Shorting the battery terminals together may cause burns or a fire.
- ▶ **Under abusive conditions, liquid may be ejected from the battery; avoid contact. If contact accidentally occurs, flush with water. If liquid contacts eyes, additionally seek medical help.** Liquid ejected from the battery may cause irritation or burns.

Service

- ▶ **Have your power tool serviced by a qualified repair person using only identical replacement parts.** This will ensure that the safety of the power tool is maintained.

2.2 Safety instructions for all saws

Cutting procedures

- ▶ **⚠ DANGER: Keep hands away from cutting area and the blade. Keep your second hand on auxiliary handle, or motor housing.** If both hands are holding the saw, they cannot be cut by the blade.
- ▶ **Do not reach underneath the workpiece.** The guard cannot protect you from the blade below the workpiece.
- ▶ **Adjust the cutting depth to the thickness of the workpiece.** Less than a full tooth of the blade teeth should be visible below the workpiece.
- ▶ **Never hold piece being cut in your hands or across your leg. Secure the workpiece to a stable platform.** It is important to support the work properly to minimize body exposure, blade binding, or loss of control.
- ▶ **Hold the power tool by insulated gripping surfaces only, when performing an operation where the cutting tool may contact hidden wiring.** Contact with a "live" wire will also make exposed metal parts of the power tool "live" and could give the operator an electric shock.
- ▶ **When ripping, always use a rip fence or straight edge guide.** This improves the accuracy of cut and reduces the chance of blade binding.
- ▶ **Always use blades with correct size and shape (diamond versus round) of arbour holes.** Blades that do not match the mounting hardware of the saw will run eccentrically, causing loss of control.
- ▶ **Never use damaged or incorrect blade washers or bolt.** The blade washers and bolt were specially designed for your saw, for optimum performance and safety of operation.

Kickback causes and related warnings

- Kickback is a sudden reaction to a pinched, bound or misaligned saw blade, causing an uncontrolled saw to lift up and out of the workpiece toward the operator;
- when the blade is pinched or bound tightly by the kerf closing down, the blade stalls and the motor reaction drives the unit rapidly back toward the operator;
- if the blade becomes twisted or misaligned in the cut, the teeth at the back edge of the blade can dig into the top surface of the wood causing the blade to climb out of the kerf and jump back toward the operator.

Kickback is the result of saw misuse and/or incorrect operating procedures or conditions and can be avoided by taking proper precautions as given below.

- ▶ **Maintain a firm grip with both hands on the saw and position your arms to resist kickback forces. Position your body to either side of the blade, but not in line with the blade.** Kickback could cause the saw to jump backwards, but kickback forces can be controlled by the operator, if proper precautions are taken.
- ▶ **When blade is binding, or when interrupting a cut for any reason, release the trigger and hold the saw motionless in the material until the blade comes to a complete stop. Never attempt to remove the saw from the work or pull the saw backward while the blade is in motion or kickback may occur.** Investigate and take corrective actions to eliminate the cause of blade binding.
- ▶ **When restarting a saw in the workpiece, centre the saw blade in the kerf and check that saw teeth are not engaged into the material.** If saw blade is binding, it may walk up or kickback from the workpiece as the saw is restarted.
- ▶ **Support large panels to minimise the risk of blade pinching and kickback.** Large panels tend to sag under their own weight. Supports must be placed under the panel on both sides, near the line of cut and near the edge of the panel.
- ▶ **Do not use dull or damaged blades.** Unsharpened or improperly set blades produce narrow kerf causing excessive friction, blade binding and kickback.
- ▶ **Blade depth and bevel adjusting locking levers must be tight and secure before making cut.** If blade adjustment shifts while cutting, it may cause binding and kickback.
- ▶ **Use extra caution when sawing into existing walls or other blind areas.** The protruding blade may cut objects that can cause kickback.

Lower guard function

- ▶ **Check lower guard for proper closing before each use. Do not operate the saw if lower guard does not move freely and close instantly. Never clamp or tie the lower guard into the open position.** If saw is accidentally dropped, lower guard may be bent. Raise the lower guard with the retracting handle and make sure it moves freely and does not touch the blade or any other part, in all angles and depths of cut.
- ▶ **Check the operation of the lower guard spring. If the guard and the spring are not operating properly, they must be serviced before use.** Lower guard may operate sluggishly due to damaged parts, gummy deposits, or a build-up of debris.
- ▶ **Lower guard may be retracted manually only for special cuts such as "plunge cuts" and "compound cuts".** Raise lower guard by retracting handle and as soon as blade enters the material, the lower guard must be released. For all other sawing, the lower guard should operate automatically.
- ▶ **Always observe that the lower guard is covering the blade before placing saw down on bench or floor.** An unprotected, coasting blade will cause the saw to walk backwards, cutting whatever is in its path. Be aware of the time it takes for the blade to stop after switch is released.

2.3 Additional safety instructions

Personal safety

- ▶ **Modification of the power tool is not permitted.**
- ▶ **Wear ear protectors.** Exposure to noise can cause hearing loss.
- ▶ **Operate the tool only together with the safety devices that belong to it.**
- ▶ **Improve the blood circulation in your fingers by relaxing your hands and exercising your fingers during breaks between working.**
- ▶ **The power tool is not intended for use by inexperienced persons who have received no special training.**
- ▶ **Keep the power tool out of reach of children.**
- ▶ **Do not switch the product on before it is at the workplace.**
- ▶ **Remove the battery before storing or transporting the power tool.**
- ▶ **Do not work overhead with the product.**

- ▶ **Do not attempt to brake the product by applying lateral pressure to the saw blade.**
- ▶ **Do not touch the clamping flange or the clamping screw while the power tool is running.**
- ▶ **Never press the drive spindle lock button while the saw blade is rotating.**
- ▶ **Never direct the power tool toward persons.**
- ▶ **Adjust the pressure applied to the saw blade and the material being cut so that the blade does not stall, possibly causing kickback.**
- ▶ **Metal chips / cuttings are sharp and may cause injury. Keep your clothing closed so that no metal chips or cuttings can find their way into your gloves, footwear or any other part of your clothing.**
- ▶ **Pay attention to where the metal cuttings are flying. The cuttings are hot and could cause a fire or injuries such as burns or cuts.**
- ▶ **Avoid overheating the tips of the saw blade teeth.**
- ▶ **Observe the national health and safety requirements.**
- ▶ **To reduce the risk of injury, use only genuine Hilti accessories and accessory tools.**
- ▶ **Dust from materials, such as paint containing lead, some wood species, concrete / masonry / stone containing silica, and minerals as well as metal, may be harmful. Contact with or inhalation of the dust may cause allergic reactions and/or respiratory or other diseases to the operator or bystanders. Certain kinds of dust are classified as carcinogenic such as oak and beech dust, especially in conjunction with additives for wood conditioning (chromate, wood preservative). Material containing asbestos may be handled only by specialists. Use a dust removal system whenever possible. To achieve a high level of dust collection, use a suitable vacuum cleaner. When indicated, wear a respirator appropriate for the type of dust generated. Ensure that the workplace is well ventilated. Follow national requirements for the materials you want to work with.**

Electrical safety

- ▶ **Before beginning work, check the working area (e.g. using a metal detector) to ensure that no concealed electric cables or gas and water pipes are present.** External metal parts of the power tool may become live, for example, when an electric cable is damaged accidentally. This presents a serious risk of electric shock.

Careful handling and use of batteries

- ▶ **Observe the special guidelines applicable to the transport, storage and use of lithium-ion batteries.**
- ▶ **Do not expose batteries to high temperatures and keep them away from fire.** There is a risk of explosion.
- ▶ **Do not disassemble, crush or incinerate batteries and do not subject them to temperatures over 80°C (176°F).** This presents a risk of fire, explosion or injury through contact with caustic substances.
- ▶ **Never continue to use or attempt to charge damaged batteries, e.g. batteries with cracks, broken parts, bent or pushed-in / pulled-out contacts).**
- ▶ **Do not use the battery as a power source for other unspecified power tools or appliances.**
- ▶ **If the battery is too hot to hold, it may be defective. In this case, place the power tool in a non-flammable location, well away from flammable materials, where it can be kept under observation and allowed to cool down. Contact Hilti Service after the battery has cooled down.**

3 Description

3.1 Overview of the product

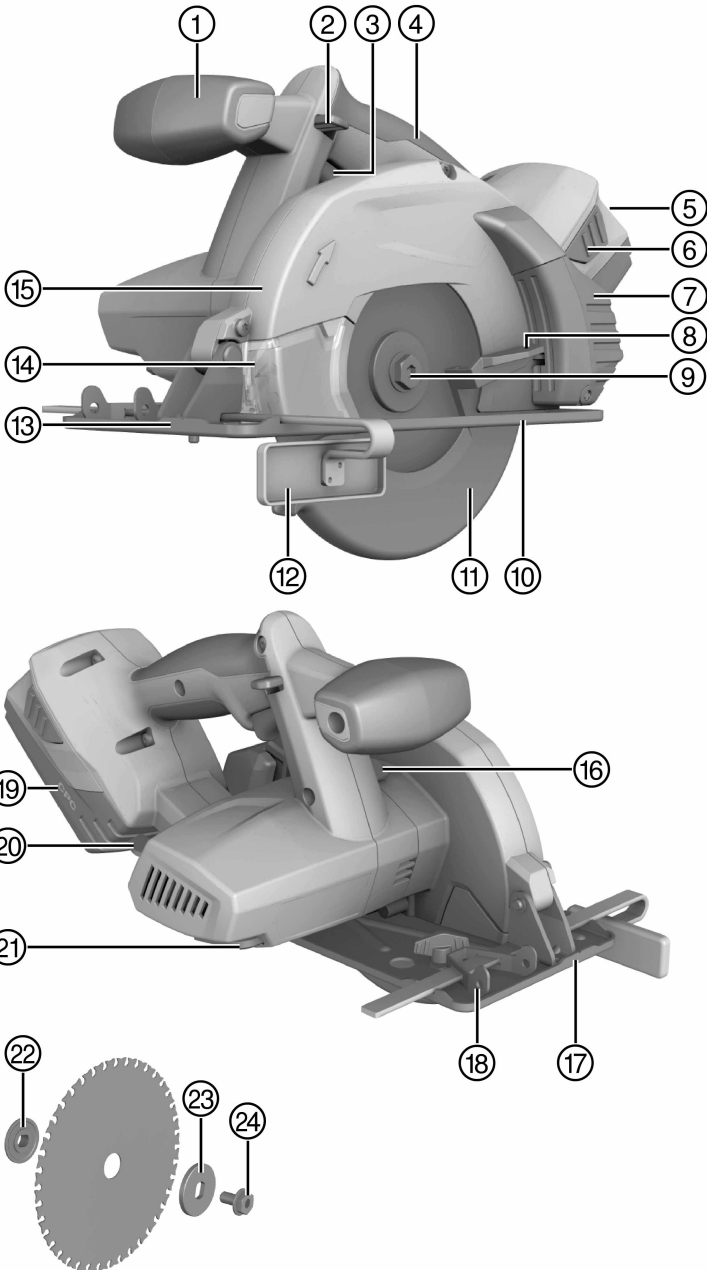

- | | | | |
|---|------------------------------------|---|---|
| ① | Auxiliary grip | ⑬ | Saw blade position indicator |
| ② | Switch-on interlock release button | ⑭ | LED / viewing window |
| ③ | On/off switch | ⑮ | Guard |
| ④ | Grip | ⑯ | Drive spindle lockbutton |
| ⑤ | Charge state and fault display | ⑰ | Cutting line indicator |
| ⑥ | Battery release button | ⑱ | Parallel guide (rip fence) clamp |
| ⑦ | Chip collector | ⑲ | Battery |
| ⑧ | Pivoting guard operating lever | ⑳ | Clamping lever for cutting depth adjustment |
| ⑨ | Drive spindle | ㉑ | Hex. socket wrench |
| ⑩ | Base plate | ㉒ | Mounting flange |
| ⑪ | Pivoting guard | ㉓ | Clamping flange |
| ⑫ | Rip fence (parallel guide) | ㉔ | Clamping screw |

3.2 Intended use

The product described is a cordless circular saw. It is designed for cutting metal or materials similar to metal. The use of saw blades not in compliance with the given specification (e.g. diameter, speed of rotation, thickness) or the use of cutting and grinding discs or blades made from high-alloy steel (HSS steel) is not permissible. Do not use the saw to cut wood or wood-like materials, plastics, gypsum board, gypsum fiberboard and composite materials.

- ▶ Use only **Hilti** Li-ion batteries of the B 22 series with this product.
- ▶ Use only **Hilti** battery chargers of the C4/36 series for charging these batteries.

3.3 Li-ion battery display

The charge status of the Li-ion battery and malfunctions of the power tool are indicated by the display on the Li-ion battery. The charge status of the Li-ion battery is displayed after pressing one of the two battery release buttons.

Status	Meaning
4 LEDs light.	• Charge status: 75 % to 100 %
3 LEDs light.	• Charge status: 50 % to 75 %
2 LEDs light.	• Charge status: 25 % to 50 %
1 LED lights.	• Charge status: 10 % to 25 %
1 LED blinks, the power tool is ready for use.	• Charge status: < 10 %
1 LED blinks, the power tool is not ready for use.	• The battery has overheated or is completely discharged.
4 LEDs blink, the power tool is not ready for use.	• The power tool is overloaded or has overheated.



Note

Battery charge status cannot be displayed while the control switch is pressed and for up to 5 seconds after releasing the control switch.

If the battery display LEDs blink, please observe the instructions given in the Troubleshooting section.

3.4 Rip fence (parallel guide)

Use of the single arm rip fence allows precise cuts to be made along the edge of the workpiece, or strips of even width to be cut.

The rip fence can be fitted on either side of the base plate.

3.5 Items supplied

Circular saw, saw blade, hex. socket wrench, parallel guide, operating instructions.



Note

To help ensure safe and reliable operation, use only genuine Hilti spare parts and consumables. Spare parts, consumables and accessories approved by Hilti for use with the product can be found at your local **Hilti** Center or online at: www.hilti.group

3.6 Accessories

Clamping flange, mounting flange, clamping screw.

4 Technical data

4.1 Circular saw

	SCM 22-A
Rated voltage	21.6 V
Weight in accordance with EPTA procedure 01	4.0 kg
Saw blade diameter	160 mm ... 165 mm
Blade disc thickness	1.2 mm
Kerf width	1.6 mm
Saw blade arbor size	20 mm
Rated speed under no load	3,500 /min
Maximum cutting depth	57 mm

4.2 Noise information and vibration values in accordance with EN 60745

The sound pressure and vibration values given in these instructions were measured in accordance with a standardized test and can be used to compare one power tool with another. They can also be used for a preliminary assessment of exposure. The data given represents the main applications of the power tool. However, if the power tool is used for different applications, with different accessory tools, or is poorly maintained, the data can vary. This can significantly increase exposure over the total working period. An accurate estimation of exposure should also take into account the times when the tool is switched off, or when it is running but not actually being used for a job. This can significantly reduce exposure over the total working period. Identify additional safety measures to protect the operator from the effects of noise and/or vibration, for example: Maintaining the power tool and accessory tools, keeping the hands warm, organization of work patterns.

Noise emission values

	SCM 22-A
Sound (power) level (L_{WA})	88 dB(A)
Uncertainty for the sound power level (K_{WA})	3 dB(A)
Sound pressure level (L_{pA})	77 dB(A)
Uncertainty for the sound pressure level (K_{pA})	3 dB(A)

Total vibration

	SCM 22-A
Vibration emission value for sawing in metal ($A_{h, M}$)	1.2 m/s ²
Uncertainty (K)	1.5 m/s ²

5 Operation

5.1 Safe operation



CAUTION

Risk of injury! Inadvertent starting of the product.

- ▶ Remove the battery before making any adjustments to the power tool or before changing accessories.

- ▶ Pull the battery out of the product to the rear.

5.2 Removing the battery

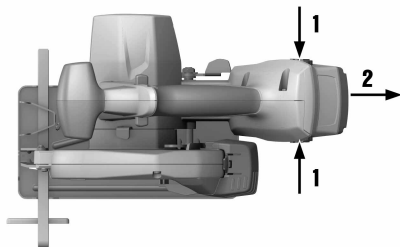

- ▶ Press both battery release buttons simultaneously and pull the battery out of the product.

5.3 Removing the saw blade



WARNING

Risk of burning injury. A hot accessory tool, clamping flange or clamping screw and the sharp edges of the saw blade present hazards.

- ▶ Wear protective gloves when changing saw blades.

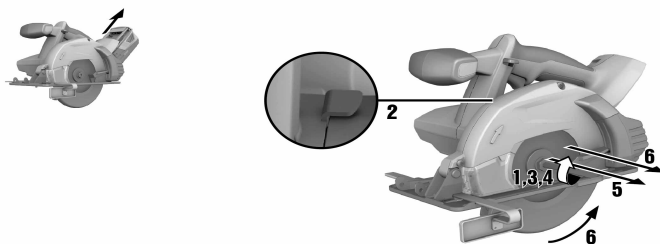

1. Insert the hex. socket wrench in the saw blade clamping screw.
2. Press the spindle lockbutton and hold it in this position.
3. Turn the saw blade clamping screw with the hex. socket wrench until the spindle lockbutton engages fully.
4. Release the clamping screw by turning the hex. socket wrench in the direction of the direction-of-rotation arrow.
5. Remove the clamping screw from the outer clamping flange.
6. Open the pivoting guard by swinging it to the side and then remove the saw blade.



Note

If necessary, the mounting flange can be removed for cleaning.

5.4 Fitting the saw blade



Note

Check that the blade to be fitted complies with the technical requirements and that it is well sharpened. A sharp saw blade is an essential requirement for a perfect cut.

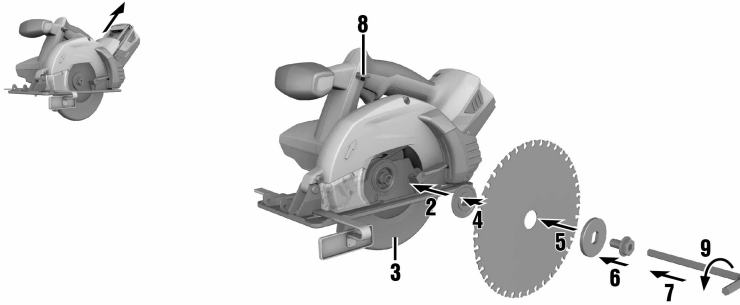

1. Clean the mounting flange and the clamping flange.
2. Fit the mounting flange onto the drive spindle the right way round.
3. Open the pivoting guard.
4. Fit the new saw blade.



Note

Observe the direction-of-rotation arrow on the saw blade and on the power tool. They must correspond.

5. Fit the outer clamping flange the right way round.
6. Insert the clamping screw.
7. Insert the hex socket wrench in the saw blade clamping screw.
8. Press the drive spindle lockbutton.
9. Secure the clamping flange with the clamping screw by turning the hex socket wrench in the opposite direction to the direction-of-rotation arrow.
 - ◀ The spindle lockbutton engages.
10. Before using the power tool, check that the saw blade is correctly seated and tightened securely.

5.5 Adjusting the cutting depth



1. Release the cutting depth adjustment clamping lever.
2. Lift the product in a scissor movement and set the desired cutting depth by closing the clamping lever.

5.6 Inserting the battery



WARNING

Risk of injury! Inadvertent starting of the circular saw.

- ▶ Before fitting the battery, check that the circular saw is switched off and that the safety lock is not pressed in (i.e. safety lock is active).

**WARNING**

Electrical hazard! Risk of short circuiting.

- ▶ Before inserting the battery, check to ensure that the battery terminals and the contacts on the circular saw are free from foreign objects.

**WARNING**

Risk of injury! Hazard presented by a falling battery.

- ▶ A falling battery may present a risk of injury to yourself and others. Check that the battery is securely seated in the circular saw.

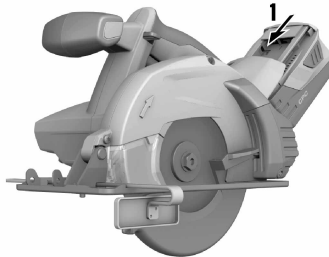

- ▶ Push the battery into the product from the rear as far as it will go and until it is heard to engage with a double click.

5.7 Sawing along a line

**Note**

Secure the workpiece to prevent movement.

Position the workpiece so that the saw blade is free to rotate beneath it.

Check to ensure that the on/off switch on the product is in the "off" position.

Position the forward section of the saw's base plate on the workpiece but do not bring the blade into contact with the workpiece.

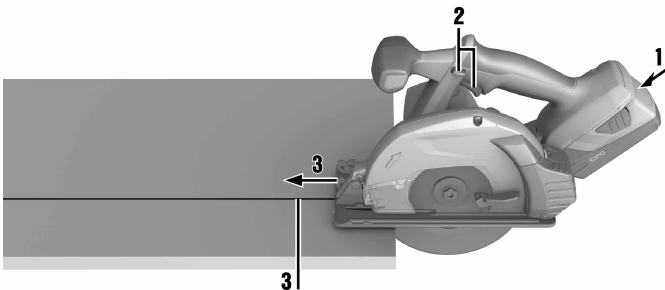

1. Fit the battery into the product.
2. While pressing the safety lock, switch the product on by pressing the on/off button.
3. Guide the product along the cutting line on the workpiece at a suitable speed.

5.8 Fitting / adjusting the rip fence (parallel guide)

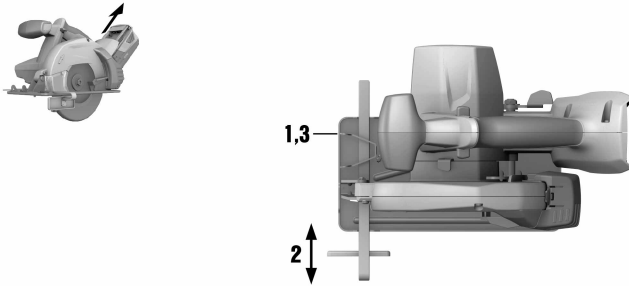

1. Press the clamp together.
2. Push the parallel guide into the base plate as far as desired.
3. Release the clamp when the parallel guide is in the desired position.

5.9 Emptying the chip collector



WARNING

Risk of injury! Hot or sharp metal cuttings / chips present a hazard.

- ▶ Wear protective gloves when emptying the chip collector.

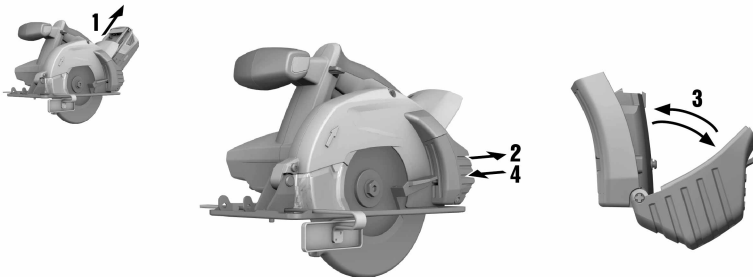

1. Remove the battery from the product.
2. Pull the chip collector away from the tool to the rear.
3. Swing the two halves of the chip collector apart and empty out its contents.
4. Push the chip collector onto the guard until it engages in position.

5.10 Procedure if the chip / dust channel is blocked

1. Remove the battery from the product.
2. Remove the chip collector.
3. Clean the chip / dust channel.



Note

Remove the saw blade if necessary.

4. Check for misalignment or binding of moving parts, breakage of parts and any other condition that may affect operation of the product.

6 Care and maintenance of cordless tools



WARNING

Risk of electric shock! Attempting care and maintenance with the battery fitted in the tool can lead to severe injury and burns.

- ▶ Always remove the battery before carrying out care and maintenance tasks!

Care and maintenance of the tool

- Carefully remove any dirt that may be adhering to parts.
- Clean the air vents carefully with a dry brush.
- Use only a slightly damp cloth to clean the casing. Do not use cleaning agents containing silicone as these may attack the plastic parts.

Care of the lithium-ion batteries

- Keep the battery free from oil and grease.
- Use only a slightly damp cloth to clean the casing. Do not use cleaning agents containing silicone as these may attack the plastic parts.
- Avoid ingress of moisture.

Maintenance

- Check all visible parts and controls for signs of damage at regular intervals and make sure that they all function correctly.
- Do not operate the cordless tool if signs of damage are found or if parts malfunction. Have the tool repaired by **Hilti Service** immediately.
- After cleaning and maintenance, fit all guards or protective devices and check that they function correctly.



Note

To help ensure safe and reliable operation, use only genuine Hilti spare parts and consumables. Spare parts, consumables and accessories approved by Hilti for use with the product can be found at your local **Hilti Center** or online at: www.hilti.com

6.1 Cleaning the dust shield

- ▶ Clean the dust shield on the chuck with a dry, clean cloth at regular intervals.
- ▶ Clean the sealing lip by wiping it carefully and then grease it again lightly with **Hilti grease**.
- ▶ It is essential that the dust shield is replaced if the sealing lip is damaged.

6.2 Checks after cleaning and maintenance



Note

After cleaning or maintenance, check that all safety devices are fitted and that they function faultlessly.

- ▶ To check the pivoting guard, open the guard fully by moving the guard operating lever.
 - ◀ The pivoting guard must close quickly and completely when the guard operating lever is released.

7 Transport and storage of cordless tools

Transport



CAUTION

Inadvertent starting during transport. Uncontrolled starting during transport may occur if the battery is fitted, thereby resulting in damage to the tool.

- ▶ Always remove the battery before transporting the tool.
- ▶ Remove the battery.
- ▶ Transport the tool and batteries individually packaged.
- ▶ Never transport batteries in bulk form (loose, unprotected).
- ▶ Check the tool and batteries for damage before use after long periods of transport.

Storage



CAUTION

Inadvertent damage caused by defective battery. A leaking battery may damage the tool.

- ▶ Always remove the battery before storing the tool.

- ▶ Store the tool and batteries in a place that is as cool and dry as possible.
- ▶ Never store batteries in direct sunlight, on heating units or behind a window pane.
- ▶ Store the tool and batteries in a place where they cannot be accessed by children or unauthorized persons.
- ▶ Check the tool and batteries for damage before use after long periods of storage.

8 Troubleshooting

- ▶ If the trouble you are experiencing is not listed in this table or you are unable to remedy the problem by yourself, please contact **Hilti Service**.

8.1 The circular saw is not in working order.

Malfunction	Possible cause	Action to be taken
The LEDs indicate nothing.	The battery is not fully inserted.	▶ Push the battery in until it engages with a double click.
	The battery is discharged.	▶ Change the battery and charge the empty battery.
1 LED blinks.	The battery is discharged.	▶ Change the battery and charge the empty battery.
	The battery is too hot or too cold.	▶ Bring the battery to the recommended working temperature.
4 LEDs blink.	The circular saw was overloaded briefly.	▶ Release the control switch and then press it again.
	The overheating prevention cut-out has been activated.	▶ Allow the circular saw to cool down to cool down and clean the air vents.

8.2 The circular saw is in working order.

Trouble or fault	Possible cause	Action to be taken
The on/off button cannot be pressed, i.e. the button is locked.	Not a fault (safety function).	▶ Press the safety lock.
Running speed suddenly drops considerably.	The saw blade jams.	▶ Do not tilt the saw blade.
Chips / cuttings are not transported into the chip collector and thus fall onto the base plate.	The chip collector is full.	▶ Empty the chip collector.
	The chip ejector channel is blocked.	▶ Clean the chip ejector channel.
The saw blade stalls.	Saw advance pressure is too high.	▶ Reduce advance pressure and switch the product back on.
The battery runs down more quickly than usual.	Very low ambient temperature.	▶ Allow the battery to warm up slowly to room temperature.
The battery does not engage with an audible "double click".	The retaining lugs on the battery are dirty.	▶ Clean the retaining lugs and refit the battery.
The circular saw or battery gets very hot.	Electrical fault.	▶ Switch off the circular saw immediately. Remove the battery and keep it under observation. Allow it to cool down. Contact Hilti service .

Trouble or fault	Possible cause	Action to be taken
The circular saw or battery gets very hot.	The product is overloaded (application limits exceeded).	► Pay attention to the power and performance rating of the product before using it, i.e. check its suitability for the job on hand. See "Technical data" section.

9 Disposal



WARNING

Risk of injury. Hazards presented by improper disposal.

- Improper disposal of the equipment may have the following consequences: The burning of plastic components generates toxic fumes which may present a health hazard. Batteries may explode if damaged or exposed to very high temperatures, causing poisoning, burns, acid burns or environmental pollution. Careless disposal may permit unauthorized and improper use of the equipment. This may result in serious personal injury, injury to third parties and pollution of the environment.
- Dispose of defective batteries right away. Keep them out of reach of children. Do not disassemble or incinerate the batteries.
- Batteries that have reached the end of their life must be disposed of in accordance with national regulations or returned to **Hilti**.

 Most of the materials from which **Hilti** tools and appliances are manufactured can be recycled. The materials must be correctly separated before they can be recycled. In many countries, your old tools, machines or appliances can be returned to **Hilti** for recycling. Ask **Hilti** Service or your Hilti representative for further information.



- Disposal of electric tools or appliances together with household waste is not permissible.

10 China RoHS (guideline on restriction of the use of dangerous substances)

The following link takes you to the table of dangerous substances: qr.hilti.com/r4891.

You will find a link to the RoHS table, in the form of a QR code, at the end of this document.

11 Manufacturer's warranty

- Please contact your local **Hilti** representative if you have questions about the warranty conditions.



Hilti Aktiengesellschaft
Feldkircherstraße 100
9494 Schaan | Liechtenstein

SCM 22-A (01)

[2011]

2006/42/EG

EN ISO 12100

2011/65/EU

EN 60745- 1

2014/30/EU

EN 60745-2-5

2006/66/EG

Schaan, 09/2015

Paolo Luccini

Head of BA Quality and
Process-Management
BA Electric Tools & Accessories

Tassilo Deinzer

Executive Vice President
BU Electric Tools & Accessories





Hilti Corporation

LI-9494 Schaan

Tel.: +423/234 21 11

Fax: +423/234 29 65

www.hilti.group

Hilti = registered trademark of Hilti Corp., Schaan



20170512