

## ⚠ WARNING

Before mounting, carefully read through the instructions start to finish. Failure to follow recommended mounting and installation instructions voids warranty. Manufacturer is not liable for any damage, injury or death that results from improper use and installation of products. By installing these products, user accepts all liabilities.

Knobs, bolts, screws, straps and locks must be periodically inspected for signs of wear, corrosion, and fatigue. Never drive with any lock, knob or rack in an open or unlocked position.

Check country specific laws regarding transportation systems and projection of objects beyond the perimeter of a vehicle. Be aware of the width and height of your cargo. All cargo will affect the vehicle's driving behavior.

For safety to your vehicle and luggage system, obey all posted speed limits and traffic cautions. Adapt your speed to the conditions of the road and the load being carried.

Consult with your Shad dealer if you have any questions regarding the operations and limits of Shad products.

Do not use Shad carriers and accessories for purposes other than those for which they were designed. Do not exceed their carrying capacity. Failure to follow these guidelines or the product's instructions will void the warranty.

Prolonged exposure to the elements might discolor fabrics and wear away plastic components.

Make sure that loads are evenly distributed inside the cargo box or bag.

Waterproof zippers and rain covers do not guarantee that the bag is totally waterproof.

Maximum load: 4 Kg. Maximum speed: 120 km/h or 74 mph.

Main storage compartment is waterproof (IP5X), external pockets are only water resistance and not recommendable for saving electronics or water sensitive gear.

**SR** and **SE** fittings work as stoppers, to prevent the bags from moving inward on the motorcycle. They must never be used alone, the straps and velcros system must always be used together.

## ⚠ PRECAUCIÓN

Antes de montar, lea atentamente las instrucciones de principio a fin. El incumplimiento de las instrucciones de montaje e instalación recomendadas anula la garantía. El fabricante no es responsable de ningún daño, lesión o muerte que resulte de un uso e instalación inadecuados de los productos. Al instalar estos productos, el usuario acepta todas las obligaciones.

Debe revisar periódicamente que las perillas, los pernos, los tornillos, las correas y los seguros no tengan señales de desgaste, corrosión o fatiga. Nunca conduzca con alguno de los seguros, las perillas o los bastidores abiertos o sin seguro.

Compruebe las leyes específicas de cada país en relación con los sistemas de transporte y la proyección de objetos más allá del ancho del vehículo. Esté al tanto de la anchura y altura de su carga. Toda carga afectará el comportamiento de manejo del vehículo.

Como seguridad para su vehículo y sistema de portaequipajes obedezca todos los límites de velocidad y avisos de tráfico. Adapte su velocidad a las condiciones del camino y de la carga transportada.

Consulte a su distribuidor Shad si tiene alguna pregunta sobre el funcionamiento y los límites de los productos Shad.

No use portacargas y accesorios Shad con otra función para la que fue destinada. No exceda su capacidad de carga. Se anulará la garantía si no sigue estos lineamientos o las instrucciones del producto.

La exposición prolongada a la intemperie puede ocasionar cambios en el color de tejidos y desgaste de componentes plásticos.

Controle que las cargas estén bien distribuidas dentro del baúl o la bolsa.

Los forros de lluvia no garantizan completa impermeabilidad de la bolsa.

Carga máxima: 4 Kg por bolsa. Velocidad máxima: 120 km/h or 74 mph.

El compartimento principal de carga es impermeable (IP5X). Los bolsillos exteriores son sólo resistentes al agua, no se recomienda guardar productos electrónicos o material sensibles al agua en ellos.

Las fijaciones **SR** y **SE** funcionan como topes, para evitar que las bolsas se muevan hacia adentro en la motocicleta. Nunca deben usarse solos, las correas los velcros siempre deben usarse juntos.

**SHAD**  
ENGINEERED FOR RIDING

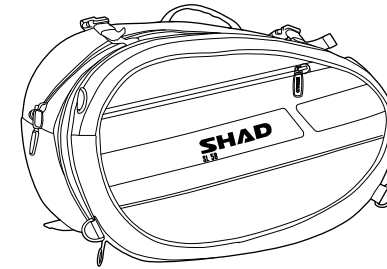

Saddle Bag  
X0SL58

	Expandable	1
	Rain cover	2
	External pocket with zipper	3
	Reflector	4
	Side Bag Holder	5
	Inner Reinforcement	6
	Padlock Zipper Slider	7
	Adjustable Straps	8

## COMPONENTS

**A** VELCRO STRAPS X6 UND

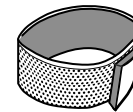

**B** RAIN COVER X2 UND

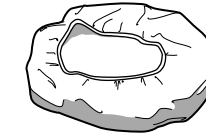

**C** SECURITY STRAP X3 UND

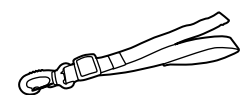

## FEATURES

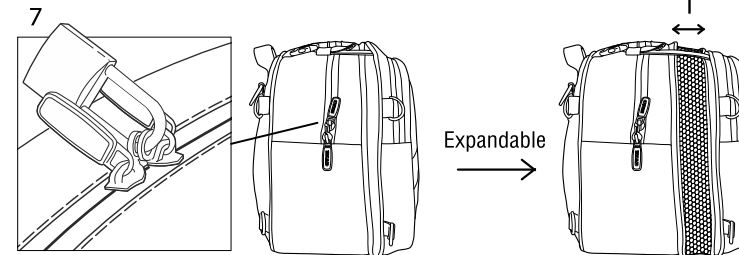

REF. X0SL58

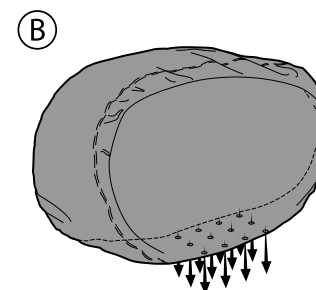

Drain holes

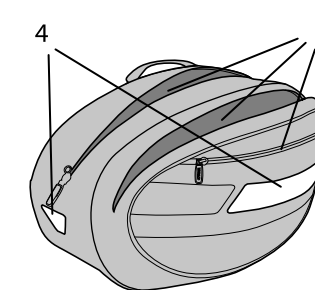

Pockets and reflective elements

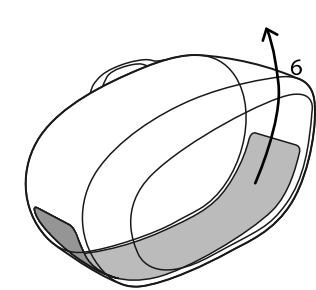

Removable Plastic Structure

UNIVERSAL INSTALLATION.  
ALWAYS FOLLOW THESE STEPS.

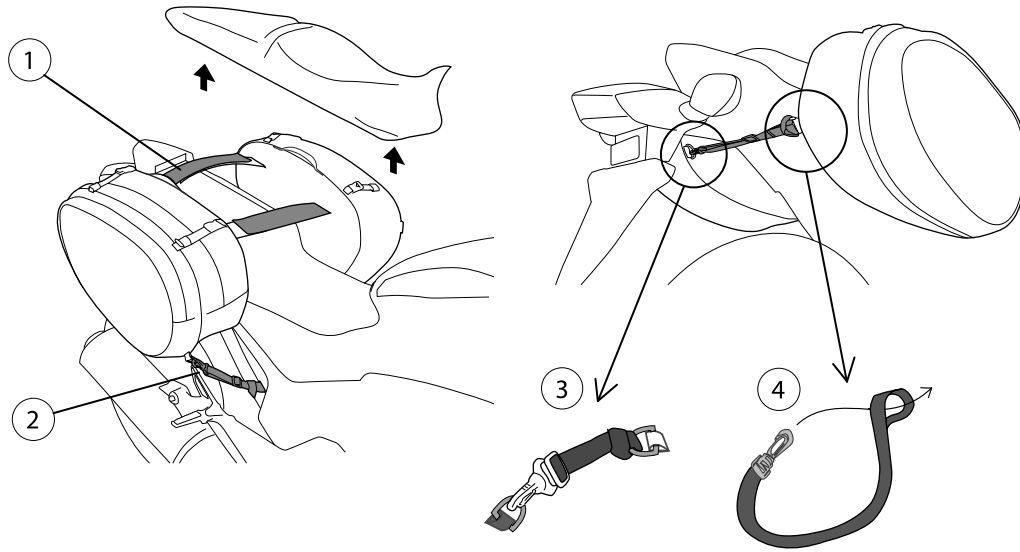

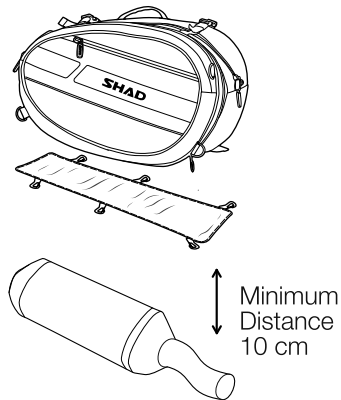

ACCESSORIES NOT INCLUDED - SOLD SEPARATELY

 Thermo Pad  
X1SB97



OPTIONAL FOR IMPROVED SECURITY FOR USAGE.

 **SR** and **SE** fittings work as stoppers  
Not an active fixing element

 SideBagHolder

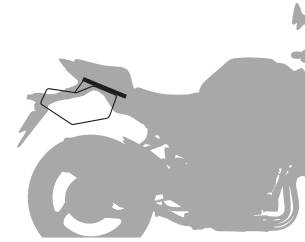

Example

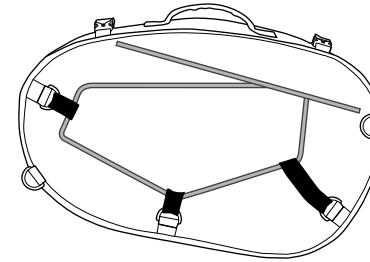

With straps

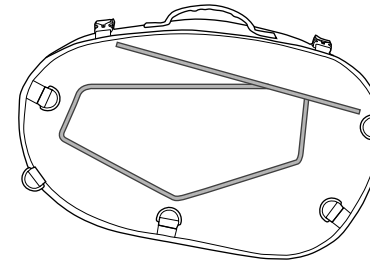

No straps

 SR fitting kit

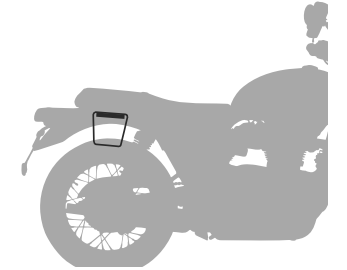

Example

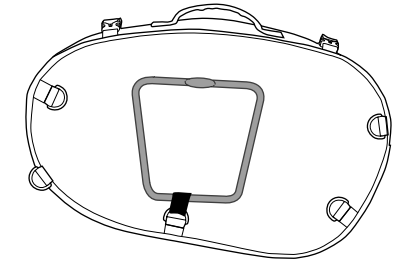

With straps

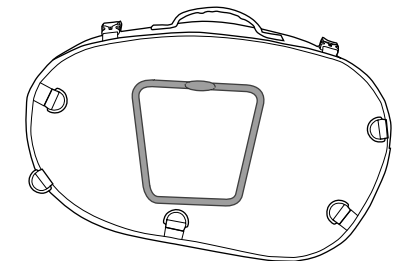

No straps

Side Bag Holder - Check compatibility with your motorbike at  
SR fitting kit - Check compatibility with your motorbike at

[WWW.SHAD.ES](http://WWW.SHAD.ES)