

# PIAA LP270 series Installation Instructions

Thank you very much for purchasing PIAA product.

Please read this entire manual before installation and use of this product.

※ The  **CAUTION** and  **WARNING** marks indicated in this manual are cautionary points related to the installation of the product.

To ensure safe and secure installation of the product, please follow these points closely.

To user

… Please keep this manual and a receipt with the name of the shop where you bought it.  
When giving this product to a third party, always include this manual together with the product.

To shop owners installing the product

… After installation of the product, make sure the customer is provided with this owner's manual.

Please read the cautionary points before installation to ensure safe utilization of the product.

## **WARNING**

- The lamp becomes very hot when turned on. When parking your car near flammable items such as dried leaves, turn off the lamp as it may cause a fire.
- Do not look directly into the light for long periods. Doing so may cause eye irritation or visual impairment.

## **CAUTION**

- The lamp and the switch harness are intended for automobile use. Do not use for any other purpose.
- This lamp is intended for use in rain (day or night), during foggy or snowy conditions where visibility is hampered. Do not use during normal driving conditions.
- Do not operate the switch while driving.
- If the lamp is kept on when the engine is not running, it may drain the battery.
- Make sure the lamp is installed securely before driving the vehicle. If a problem is found, fix it immediately.
- Check for any loose screws that hold the lamp in place before driving. If you find any loose screws or bolts (if a bracket is used), tighten them securely. If you notice a loose part while driving, inspect the section immediately and make the necessary adjustments.
- Avoid repeatedly turning the lamp off and on as it may reduce the overall life of the LED.
- Some vehicles produce a high voltage electric charge when the engine is started. Avoid loading extra voltage to lamps by turning the switch off when you start engine.
- Avoid needless disassembly of the lamp or the switch harness as it may cause it to fail.
- If the lamp and/or the switch harness is removed and set aside for safekeeping, wipe away all dust or grime and store in a place free of moisture.
- If the lens is cracked or damaged in any way, verify whether there is any damage to the harness. If there is any damage to the cord covering, replace it immediately.
- Avoid injury when replacing the harness and the switch harness. Please dispose of it as a non-combustible item.

Please read the installation procedures thoroughly beforehand.

## CAUTION

- In order for the lamp to perform at its full potential, use the relay harnesses manufactured by PIAA.
- All work procedures should be carried out in a location with adequate space. Place the shift lever in neutral or in the parking position. Turn off the engine and set the parking brake.
- Make sure the engine compartment is adequately cool before starting work. Do not begin work if engine parts such as radiator, oil-cooler or turbo parts are still hot.
- Do not add additional holes to the main body of the lamp. Also, do not apply adhesives or stickers to the lamp parts.
- Do not modify the lamp harness or the switch harness in any way. Such modifications may cause it to overheat or short. In some cases, it may cause the vehicle to catch fire. PIAA will not be liable for damage caused by such modifications.
- When removing the battery terminals, do not touch the (-) and (+) terminals simultaneously. An electrical shock may occur. Wear rubber gloves when carrying out such work procedures.
- Make sure the (-) and (+) terminals do not make contact with metal. It can be extremely dangerous if a short occurs.
- Make sure all bolts are tightly secure. If there are any loose bolts tighten them accordingly.
- After installing the lamp, adjust the lamp so the beam shines at least 40m in front of the vehicle. Also, adjust the lamp a little toward the left so that it does not shine directly into the eyes of the opposing driver of a vehicle. (as traffic laws stipulate - refer to p.6 for adjustment procedures)
- After installing the lamp, make sure the headlamps, wipers and horn are working normally.
- When the battery terminal is removed, memory related to the clock, radio, audio system etc, will be affected. After all work procedures are completed, reset to the original settings. (For adjustment procedures refer to your car's instruction manual)

Caution Regarding Wiring / Please read thoroughly

## WARNING

- When installing the wiring harness, strictly follow the cautionary points mentioned below. Incorrect or faulty wiring may cause the lamp to operate improperly. In some cases, it may cause the vehicle to catch fire.

## CAUTION

- Before you begin always remove the (-) and (+) terminals.  
Always remove the (-) terminal first and make sure a short does not occur.
- When removing the battery terminals, always turn the key to OFF and remove it. Turn all other electrical units off such as the light switch.
- When removing the battery terminals, if a cord (for an electrical unit) is connected, wind a length of vinyl tape around the (-) and (+) terminals to clearly identify them.
- Verify the (+) terminal (white) and earth (black) before connecting.
- Do not obtain (+) voltage from the alternator.
- Obtain the (+) current necessary for the switch from the (+) current used for the light switch.  
(Do not use the same current used for a computer, radio or audio system)
- Install the switch harness in a position where it will not make contact with high temperature surfaces such as the engine, radiator or engine compartment.
- Arrange the switch harness so that it does not make contact with moving parts.
- Do not place the switch harness on high-voltage wires such as brake or air-conditioning wires.
- If the switch harness makes contact with a part of the engine, apply a length of ordinary cushioned tape around the harness.
- When connecting the connector, insert until you hear an audible "click"
- When removing the connector, hold the main body of the connector and pull it out. If excess force is used to pull the cord, it may damage the connection, which could cause it to overheat.
- Make sure the harness does not sag. Use a harness band of vinyl tape to secure it in place to wiring inside the engine compartment.
- Before connecting it to the battery, verify the wiring arrangement.
- When connecting the battery terminal and or other electrical units, do not mistake the (-) and (+) terminals. Always start with the (+) terminal.
- After all wiring is complete, confirm that it works properly. If it fails to activate, refer to "[3] Troubleshooting" section of this manual.

## Product Details

※ Verify all the parts are included. If a part is missing, please contact your local distributor.

- ① Lamp main unit (2 units)

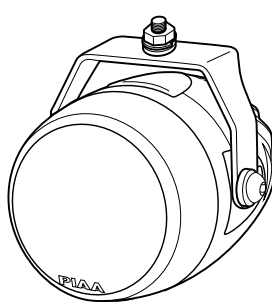

[FOG]

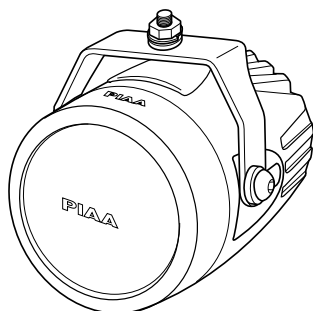

[DRIVING]

This Package encloses either LED Fog Lamp or LED Driving Lamp.

- ② Pre-assembled relay harness with fuse and switch [1 set]

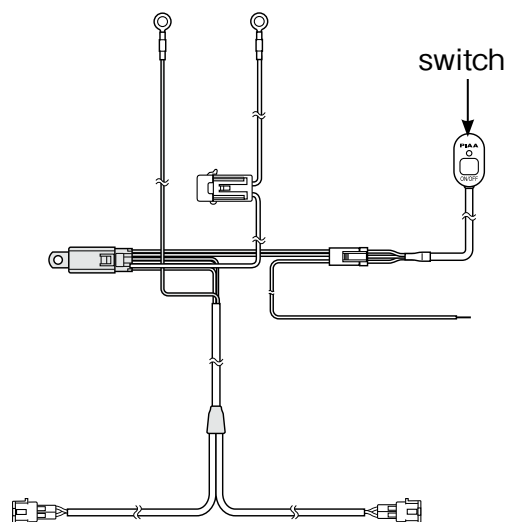

- ③ Hexagonal wrench (1 pc)

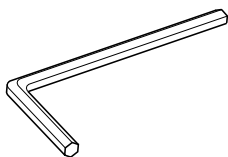

- ④ One-touch connector (1 pc)

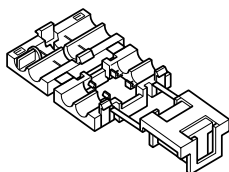

- ⑤ Wire tie (5 pcs)



- ⑥ Double-stick tape (1 pc)

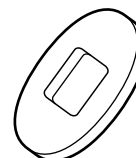

## Tools Required

※ Please use the tools indicated below.

- Tape

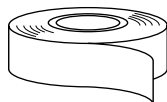

- Pliers

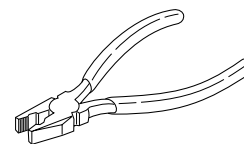

- 13mm wrench

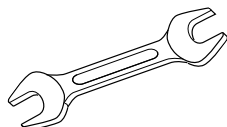

- Flat head screwdriver

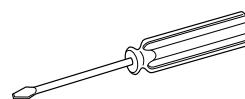

● This Instruction Manual (IM) refers to the "LED Driving Lamp" system but can also be applied to the "LED FOG Lamp" system.

# [1] Lamp installation

For lamp installation, a hole with a diameter of 8mm is required. Make necessary preparation such as installation of lamp bracket.

## ⚠ CAUTION

- When using a commercially supplied lamp bracket, before removing the bolt that is already installed on the car body, make sure that it is safe to do so.
- The lamp should be mounted in an area sufficient to support its size and weight. Failure to do so may result in excess vibration leading to shorter bulb life and or physical damage to the lamp or your vehicle.
- Do not attempt to install the lamp directly to any plastic part of the car body. If the lamp needs to be installed on the plastic reinforcement materials should be placed on both sides of the plastic part.
- When installing, make sure the lamp body, lens and rim are not touching the bumper and other plastic parts. Such plastic parts might deform.
- The lamp installation surface should be flat.
- Do not use an Impact wrench when mounting the lamp.
- Over torqueing the mounting nut on the base could cause base failure and void the warranty.
- You must utilize the washer, lock washer, and rubber base.
- Torque specifications on the base mounting nut is 9.5ft · lbs (13N · m)

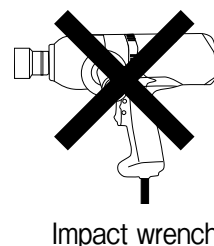
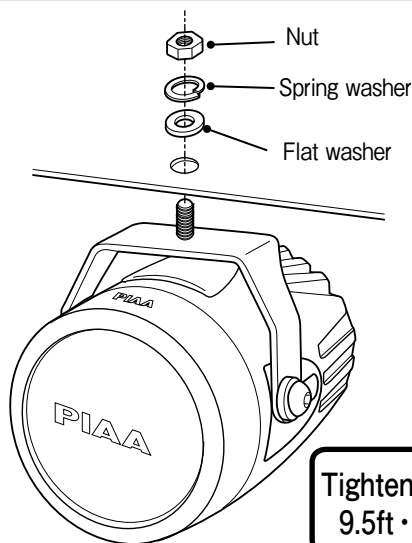

### Assembly Instruction of the bracket and the lamp body

Refer to below drawings; assembly type is different depending on installation locations.

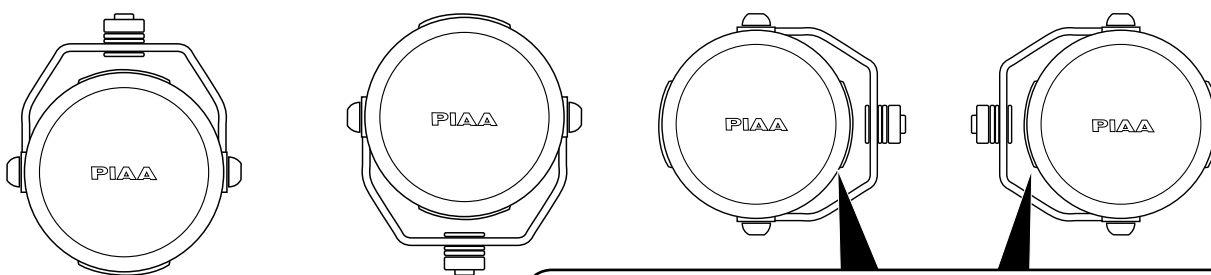

Make sure the installation position is correct and the logo will not be upside down.

To prevent any scratches or damages, make sure to protect the lamp body by a thick tape or so when removing the resin cover with a tool. Such damages will not be covered by the extended warranty.

## ⚠ CAUTION

- The lamp should be tightened to the degree that the lamp body cannot be moved by hand.
- The lamps are designed to be mounted upright. It is very important that you make sure that the "PIAA" etched in the lens reads right side up.

## [2] Relay Harness Installation Sequence

The numbers shown in the figure below indicate the sequence the parts should be installed.

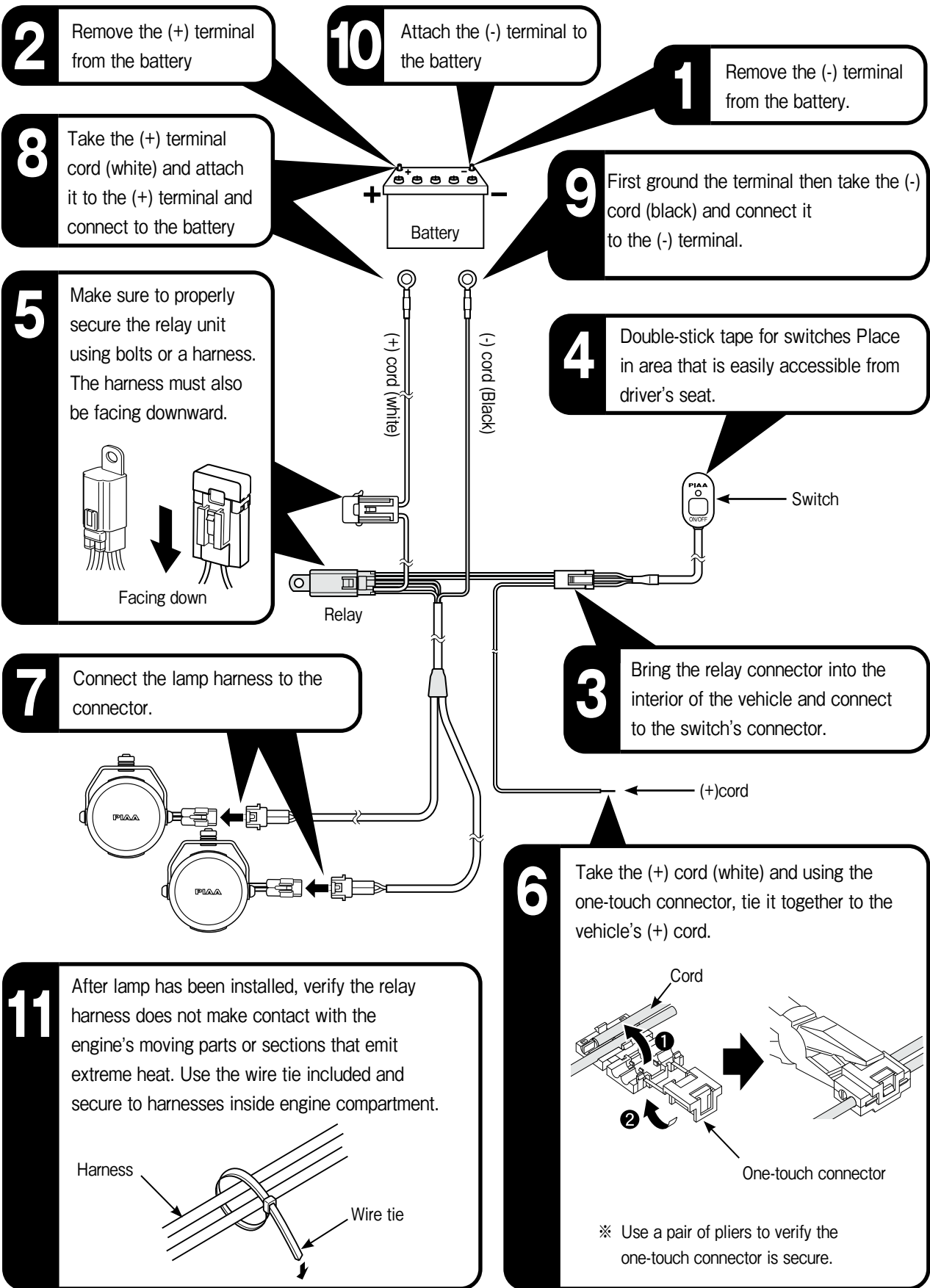

### DRIVING / Spot Light Aiming

Typically, driving lights are mounted above the front bumper about 14 cm -30 inches from the ground to provide extra high beam illumination. Driving lights can be mounted below the bumper, although they will not be as effective because the light will hit the ground sooner and reduce the range of the light.

Visual aim is made with the center of the beam hot spot 1.5 inches below the lamp center at 25feet with the lamp facing straight forward. (see below.)

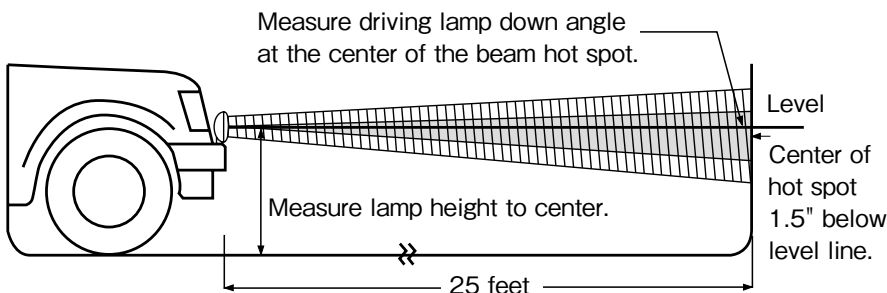

### CAUTION

- Do not use driving lights into oncoming traffic. Driving lights should never be the only forward light source. Driving lights should only be used with the headlamp high beams.

### FOG Light Aiming

There are two important issues to address when installing fog lights, the first is to minimize the amount of return glare into the drivers eyes, and the other is to minimize glare into oncoming eyes. Both of those issues must be accomplished while putting as much light as possible on the road.

These fog/foul weather light aiming instructions are suggestions taken from common practice and the S.A.E. standard J583. Some modifications to these instructions may be necessary to minimize glare.

Visual aim is made with the top of the beam 4 inches below the lamp center at 25 feet with the lamp facing straight forward. (See below.)

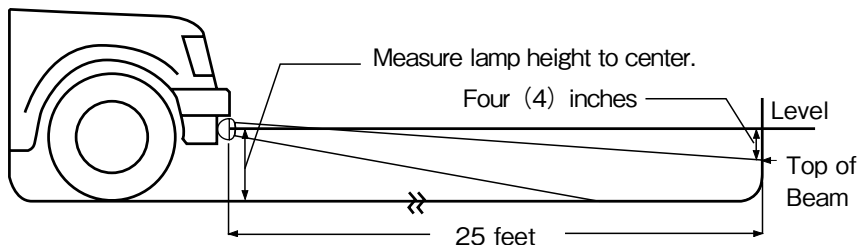

### CAUTION

- Only use fog lights if they are aimed properly. Fog lights should never be the only foreword light source. Fog lights should be used with headlamp low beams.

### **[3] Troubleshooting……Verify each section according to the following.**

#### **1 After installation, if the lamp does not activate**

→ Check the wiring and make sure there are no faulty or irregular connections .

##### ● If the switch illumination does not light up.

- Verify the (+) wire from the switch is properly connected. If it is not correctly connected it will not activate.
- Verify the fuse located on the vehicle' s wiring system. (the switch' s (+) wire should be connected to the fuse box). If it is burned out, connect it to another circuit.
- If the switch itself is faulty, the same symptoms may exist. We recommend that the entire switch unit be replaced.
- Check the fuse for the switch harness. If it is burned out, follow instructions indicated in [ 3] Fuse replacement Procedures].

##### ● The switch illumination lights up but when operating does not work.

- Check the connecting (-) cord to the body earth.
- There may be cases where each terminal related to specific sections may be incorrectly connected. Check for any loose wires and also for dirt or grime.
- Check the switch operation. If an abnormality is found, replace it accordingly.

#### **2 If the LED suddenly fails to light up …**

- Check the fuse located on the vehicle' s wiring system. If it is burned out, replace accordingly.
- Check the fuse for the switch harness. If it is burned out, follow instructions indicated in [ 3] Fuse replacement Procedures].
- There may be cases where each terminal related to specific sections may be incorrectly connected. Check for any loose wires and also for dirt or grime.
- Check the switch operation if an abnormality is found, replace it accordingly.

#### **3 Fuse replacement procedures**

- A short circuit may have occurred. Check the wiring system. If any type of damage is found replace accordingly. (Non-replacement may pose a potential danger) (Short circuits are mainly caused when wires are caught in the assembly or when there is a gap in the sleeve connected to the lamp harness).

## **[4] PIAA LIMITED WARRANTY**

With the exception of bulbs, PIAA Corporation, USA ("PIAA") warrants its products to be free from defects in workmanship and materials under normal use for as long as the original purchaser owns them.

### **EXCLUSIONS**

This Limited Warranty specifically excludes defects resulting from misuse, abuse, neglect, alteration, modification, improper installation, unauthorized repairs, submersion, theft, vehicle crash, or by any other type of impact. Except for the Limited Warranty stated above, there are no warranties of PIAA products or any part thereof, whether express or implied. Any implied warranty of merchantability or any warranty of fitness for a particular purpose is expressly disclaimed. Some states do not permit the disclaimer of implied warranties.

### **LENS CRACKS**

Crash or impact damage is not covered. This can be determined by a chip or scrape on the lens or the housing. Stress cracks sometimes occur when the lens is subjected to sudden and extreme temperature changes. A stress crack has no chip or other sign of impact. Stress cracks are covered under warranty.

### **EXCLUSION OF DAMAGES**

In no event shall PIAA be liable for any damages whatsoever (including, without limitation, consequential damages, incidental damages, or damages for loss of use, loss of business profits, business interruption, loss of business information, loss of time, inconvenience, or other losses) arising out of the use, misuse, or inability to use a PIAA product. PIAA reserves the right to change the design its products without any obligation to modify any previous product. This warranty gives you specific legal rights. You may also have other rights that vary from state to state.

### **REPAIR AND REPLACEMENT**

If a PIAA product is suspected of being defective, it must be submitted freight prepaid, to either an authorized dealer or distributor for warranty inspection. The receipt or other proof of purchase and a description of the problem must be included. The returned product will be inspected. If the product is found to be defective and covered by this Limited Warranty, the sole remedy is repair or replacement, at PIAA's option. A repaired or replacement product will be shipped back at no charge, and will be warranted to be free from defects in workmanship and materials under normal use for as long as the original purchaser owns it. Removal, installation, or reinstallation costs are not covered by this Limited Warranty.

**PIAA CORPORATION**

[www.piaa.co.jp](http://www.piaa.co.jp)

[www.piaa.com](http://www.piaa.com)