

Instruction Manual



Digital VELONA - twin function (Speed + RPM)

PRODUCT FEATURES

- Compact size, φ60×45mm (Depth)
- Stainless steel + black painted
- Black LCD display with white LED backlit
- KM/H (0-399KM/H) & MPH (0-250MPH) selectable
- Odometer: 0-99,999km (mile)
- Dual Trip Meter: 0-9,999.9km (mile)
- Tacho(RPM) meter: 0-20,000RPM * Min.10RPM
- RPM bar graph: "full scale" adjustable
- Ability to connect to OEM speed sensor, if the vehicle is equipped with an electrical speed sensor.
- V-shaped bracket included
- Power DC9-16 (regular 12V)

CAUTION

- Read all instructions before use.
- May need to purchase optional parts for some vehicles.
For vehicles that are NOT equipped with an electrical speed sensor, use the Proximity Speed Sensor (sold separately).
Or use a Speed Pulse Converter (sold separately) that turns mechanical speedometer cable movement into electrical pulse, if the vehicle comes with a mechanical speedometer cable.
(See the optional parts section in this manual.)
- Designed to be used on 12V system vehicle.
(Digital VELONA does NOT work with a 6V system or battery-less system.)
- Digital VELONA might not work normally when used together with other device that emits much noise.
- Use Digital VELONA for the intended purpose of use.
- Digital VELONA is for universal use, so it needs wiring for installation.
(If you are not sure about installation, consult an experienced dealer.)
- Do the wiring referring to the vehicle owner's manual.
- Do NOT disassemble Digital VELONA. It may be damaged and water may come in.
- Do NOT leave Digital VELONA in high heat when not used for a long time.
- Do NOT hit, drop and/or give a shock on Digital VELONA. It may be damaged.
- Avoid contact with gasoline, brake fluid or other chemicals. It may be damaged.
- After installation, check to see if all the parts are correctly installed, and to see if all the screws are properly tightened.
- Inspect all installed parts after 100km driving. Periodical inspection is required every 500km(300mile). If anything unusual found while driving, pull over at a safe place to check.

COMPONENTS

NO.	DESCRIPTION	REMARKS	Q'TY
①	Gauge Unit		1
②	V-Bracket		1
③	Exitension Wire Set	5pcs	1
④	Cap screw	M5 x 10	2
⑤	Spring washer	M5	2

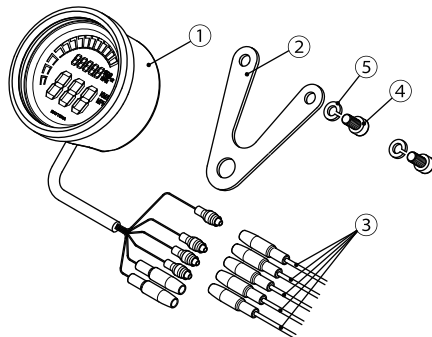

WIRING

⚠ Disconnect the ground wire from the negative post of vehicle's battery before installation.

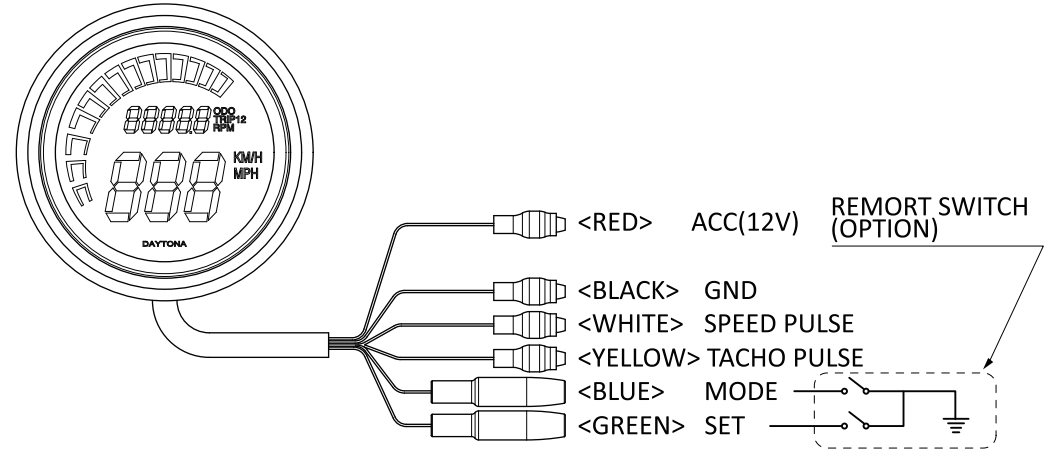

OEM Wiring Color List

	RED ACC(12V)	BLACK GND ⊖	WHITE SPEED PULSE
HONDA	black/brown or pink/blue	green	pink/green
YAMAHA	red/white or light brown	black or black/white	white/yellow or pink
SUZUKI	orange/green	black/white	pink
KAWASAKI	brown/white	black/yellow	pink or pink/blue

※OEM Wiring Color List is only for your reference. Wiring color might be different between the model, country, or model year. Please check with the vehicle owner's manual or voltmeter.

RPM pulse detection <Three options>

From ignition coil	From spark plug code	For 2000&up Harley-Davidson only
<p>Connect the yellow wire to the positive terminal/wire of the ignition coil</p>	<p>Wind the yellow wire 5-6 times on the spark plug code, and then tape to fix it.</p>	<p>Connect the yellow wire to the red wire of the vehicle's crank position sensor</p>

OPTIONAL PARTS

<p>REMOTE SWITCH <#87047(black)> <#87082(chrome)></p>	<p>TWIN SIGNAL SPEED PULSE CONVERTER <#87430></p>	<p>PROXIMITY SPEED SENSOR <#87038></p>	<p>RPM INDUCTION WIRE SET <#87170></p>
---	---	--	--

HOW TO SET & NORMAL OPERATION

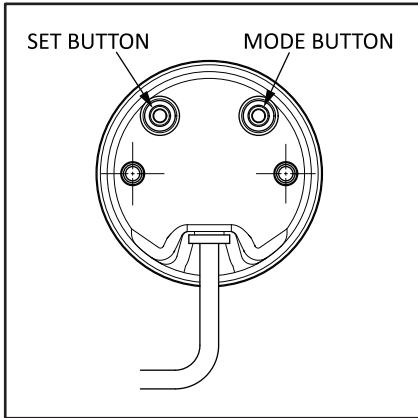

※Read all instructions before setting.

Especially for "speed calibration", initially decide which way you do

- ① Auto Calibration Mode
- or
- ② Speed Adjust Mode
- or
- ③ Manual Adjustment Mode.

If the vehicle is equipped with an electrical speed sensor,
① Auto Calibration is recommended.

MOUNTING ANGLE

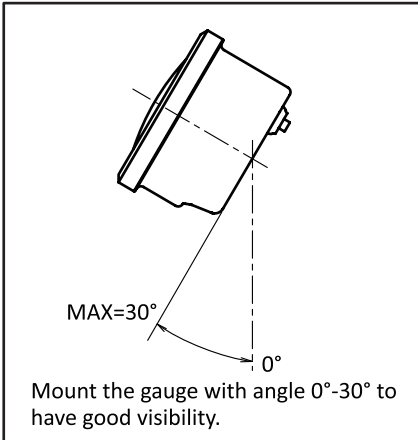

NORMAL OPERATION

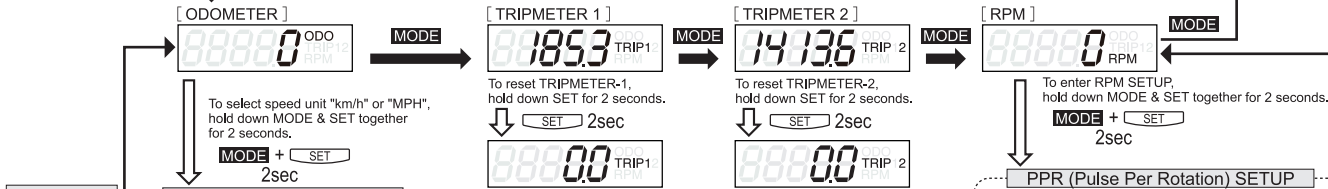

HOW TO SET

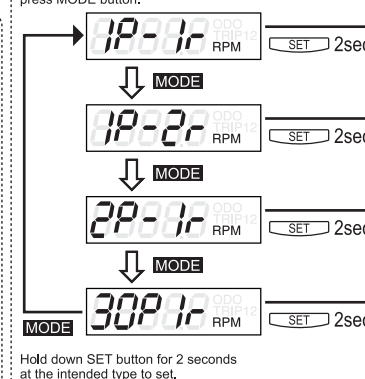
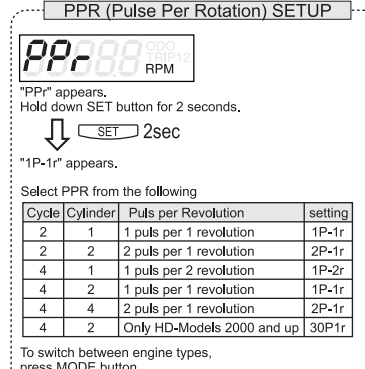
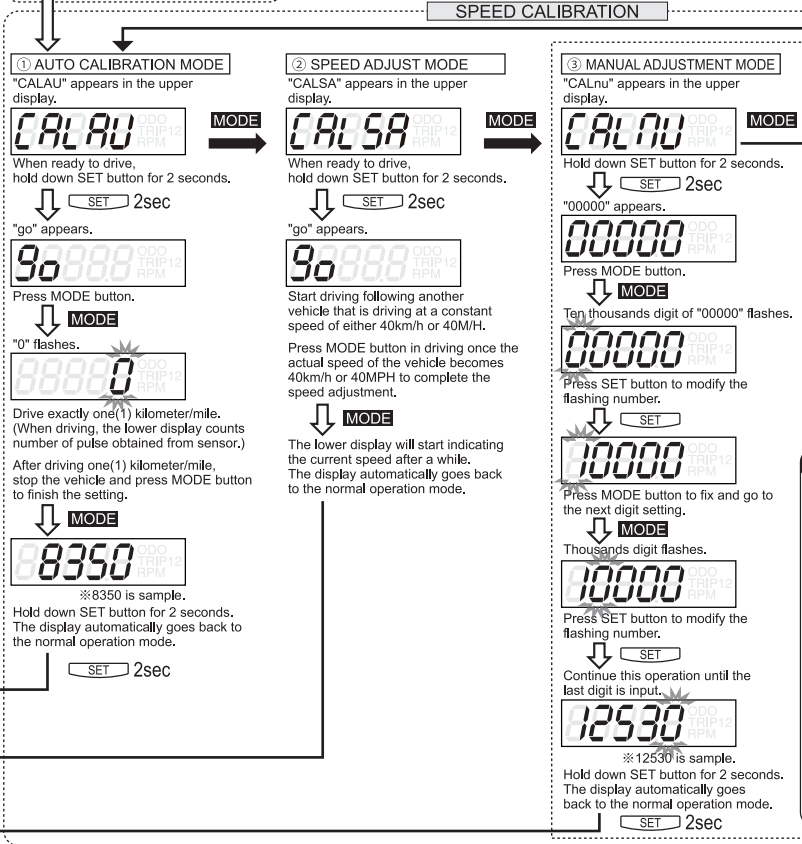
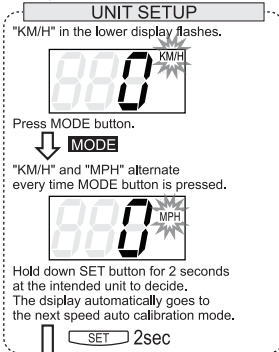

Attention

Calculate the value of "pulse per km" by **A** ÷ **B** and input this value at MANUAL MODE.

A pulses per revolution
Enter the AUTO CALIBRATION MODE, turn the wheel exactly 10 revolutions. The display shows the pulses per 10 revolutions. Divide this value by 10.

B tyre circumference (km)
Measure your tyre circumference in "cm" and divide by 100,000 to be "km".

A ÷ B = pulses per km

Then enter MANUAL MODE and input this value as shown on the left.

