

***DAYTONA***

**JAPAN  
2022-2023**

**50<sup>th</sup>**

**SINCE 1972  
ANNIVERSARY**

# DAYTONA

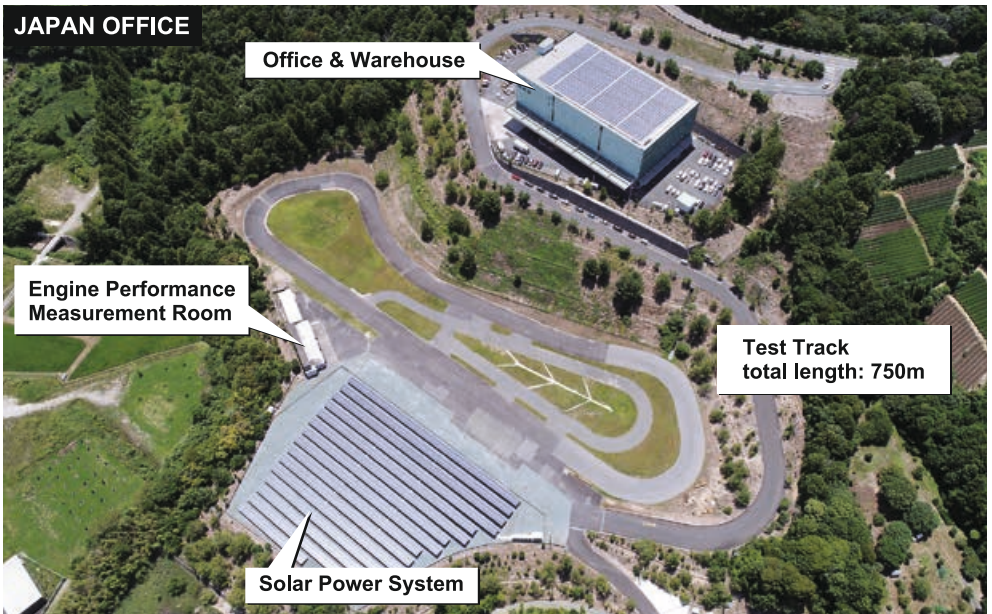

## DAYTONA CORPORATION

4805 Ichimiya, Mori-machi,  
Shuchi-gun, Shizuoka, 437-0226, Japan  
<https://daytona-europe.com>

# For all the motorcycle lovers,

In 2022, Daytona reaches another milestone, the 50th anniversary of our foundation in 1972.

Daytona's roots go back as far as 1972, started as Abe Trading in Japan by Henry Abe. At first, it was a small business dealing with export motorcycle parts with the goal of 'Paving the way for Motorcycle Culture in Japan'. Since then, Daytona has supported motorcyclists' exciting riding moments by providing customization parts that suit the era.

As Daytona, we will continue supporting to make lives even more exciting and meaningful through motorcycles with our utmost gratitude to everyone who has supported us until now and loves their motorcycles.



President  
Tetsu, Oda

Founder  
Henry, Abe

CEO  
Scott, Suzuki

# VELONA-W



photo by : KASPEED Custom Motorcycles

 Two Needles  
(SPEED & RPM)

 200km/h (MPH)

 0-9,000rpm

 0-99,999.9km (mile)

 1 & 2, 0-99,999.9km (mile)

 DC 10.0-16.0V

  Memory & Recall

    Indicators

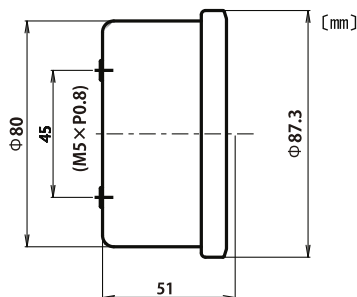

- Stainless-steel housing
- Incl. V-shaped bracket



#89364





# VELONA80



#87790  
[200]



#87789  
[140]



#87791  
[260]

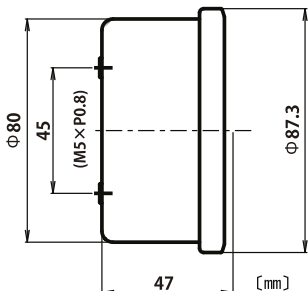

- Stainless-steel housing
- Incl. V-shaped bracket

- SPEED 140/200/260 km/h (MPH)
- RPM 0-20,000rpm
- ODO 0-99,999.9km (mile)
- TRIP 1 & 2, 0-99,999.9km (mile)
- VOLT DC 10.0-18.0V
- MAX SPEED
- MAX RPM
- Memory & Recall
- with Red LED lamp
- FUEL SIGNAL INDICATOR
- HIGH BEAM INDICATOR
- NEUTRAL INDICATOR
- WARNING
- Indicators



#87792  
[9000]



#87793  
[15000]



- SPEED 0-399km/h (0-260MPH)
- RPM 9000rpm / 15000rpm
- ODO 0-99,999km/h(mile)
- TRIP 1 & 2, 0-99,999.9km (mile)
- VOLT DC 10.0-18.0V
- MAX SPEED
- MAX RPM
- Memory & Recall
- with Red LED lamp
- FUEL SIGNAL INDICATOR
- HIGH BEAM INDICATOR
- NEUTRAL INDICATOR
- WARNING
- Indicators

# VELONA60

■ **SPEED** (km/h or MPH)  



#88642  
[200]



#88641  
[140]



#88643  
[260]



#86863  
[200]



★  
#85833  
[200]



#86861  
[260]



★  
#86267  
[260]

■ **RPM**



#88644  
[9000]



#88645  
[15000]



#88677  
[15000]



#86864  
[8000]



★  
#85835  
[8000]









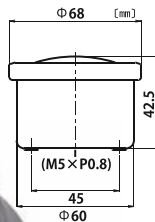





#87527  
[15000]



#86862  
[18000]



													Indicators
88641 88642 88643	○	○	○	○	○								○
86863 85833 86861 86267	○	○	○	○		○							
88644 88645 88677				○			○	○	○				
86864 85835 87527 86862						○	○	○		○	○	○	

★ CHROME case

# VELONA48



#87383  
[140]









#87386  
[200]



#87389  
[260]

## ■ SPEED E \*\*\*

-  140/200/260 km/h (MPH)
-  0-99,999.9km (mile)
-  1 & 2, 0-99,999.9km (mile)
-  DC 10.0-18.0V
-  Memory & Recall
-  Changeable backlight  
White / Blue / Orange

**3-colors backlit**

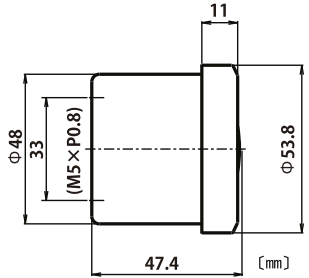

- Stainless-steel housing
- Incl. V-shaped bracket







#87392  
[9000]



#87395  
[15000]







## ■ RPM

-  9000rpm / 15000rpm
-  DC 10.0-18.0V
-  Memory & Recall
-  with Red LED lamp
-  Changeable backlight  
White / Blue / Orange

# Digital VELONA E \*\*\*



#85836

-  SPEED & RPM
-  0-399km/h (0-250MPH)
-  0-20,000rpm
-  0-99,999km(mile)
-  1 & 2, 0-9,999.9km(mile)
-  RPM bar-scale  
programmable

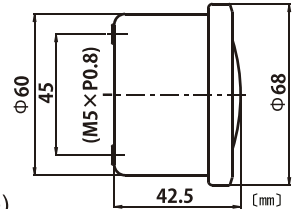

- Stainless-steel housing
- Incl. V-shaped bracket

# VELONA-Volt

**NEW**



#80859



#80860



8.0 ~ 16.0V



Low voltage alert by Red LED backlight when less than 12V

- Stainless - steel housing
- Incl. V-shaped bracket

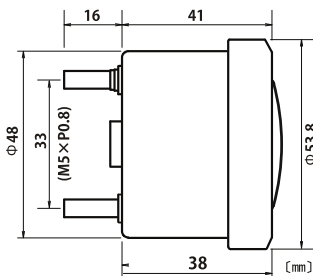



# VELONA Options

## ■ Remote Switch



#87047

Operates VELONA gauges remotely instead of pressing bottom buttons.

- For  $\Phi 22.2/25.4$ mm handlebars
- Wiring outside or inside handlebar possible
- Max. current capacity 50mA
- Width 12mm

## ■ Bracket of VELONA80, VELONA60



#80203



- mount pitch adjustable 63-112mm

## ■ Combinative Brackets for VELONA48



#87768



#87785



## ■ Combinative Brackets for VELONA60



#87404



#87403



## ■ Anti-vibration Brackets for VELONA60



#61197



#63526



#63527



#63528



#63529

# VELONA Speed Sensor & Accessories

## ■Speed Pulse Converters



#87755

Dia10 insert

TRIUMPH, HONDA,  
BMW etc.  
Wire length : 1280mm



#87041

Dia18 plug connection

YAMAHA SR400/500  
etc.  
Wire length : 1280mm



#87143

Dia15 insert

HONDA, SUZUKI etc.  
Wire length : 1800mm



#87429

M12 thread female

YAMAHA, SUZUKI,  
DUCATI, MOTO GUZZI  
etc.  
Wire length : 1200mm



#88457

For BMW

BMW boxer models  
Wire length : 700mm

R65, R80, R100,  
R100GS



#87430

Universal

Wire length : 650mm



OEM  
SPEEDOMETER CABLE

## ■Proximity Speed Sensor



#87038

"Non-contact" type speed sensor,  
can generate electrical pulse signal from most vehicles.

Wire length : 2000mm  
Max.current : 100mA

## ■Temp Sensor (R1/8)



#80228

Wire length : 1000mm

## ■RPM Induction Wire Set



#87170

For easy detection of  
RPM pulse connecting  
to spark plug wire or  
to ignition coil

## ■RPM Pulse Rectifier



#92333

For cases  
that RPM pulse cannot  
be detected well or  
RPM signal is unstable

# LED Micro Indicator

## ■ALPHA

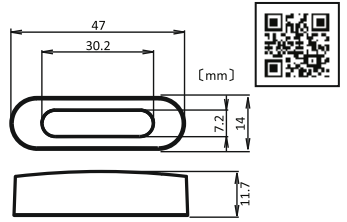

※Real scale

Body : ABS  
 Clamp : CNC Aluminum  
 for  $\Phi 22.2/25.4$ mm handlebars  
 Indicators : With plain LED lamps



#86531 BLACK

#86532 CHROME

## ■BETA

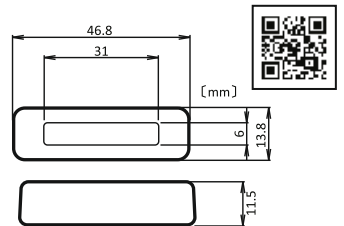

※Real scale

Body : CNC Aluminum  
 Bracket : SUS  
 Indicators : With symbols



#87467 BLACK

#87468 CHROME

# Multifunction Cockpit

■ DEVA  







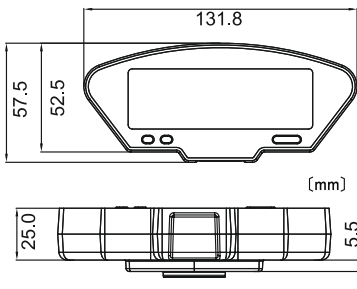

















#89363





- ABS housing
- Incl. stainless-steel bracket
- Incl. magnetic speed sensor

 0-399km/h or 0-250MPH	 0-10,000 or 20,000rpm
 0-99,999.9km (mile)	 RPM bar-scale 10,000/20,000rpm
 1&2, 0-9999.9km (mile)	 Memory & Recall
 0-99,999.9km (mile) Set start from any value	 Bar-graph blinking
 Memory & Recall	 Fuel Gauge (100Ω,250Ω,510Ω)
 8.0-18.0V	 0°C ~ +150°C (+32°F ~ +356°F)
 Low Battery Warning	 0°C ~ +150°C (+32°F ~ +356°F)
 12h or 24h	 -10°C ~ +60°C (+14°F ~ +140°F)
 N, 1, 2, 3, 4, 5, 6 Top 4/5/6 selectable	
      Indicators	

Option



#89845

Handle clamp kit

#89846

Oil temp sensor

#89847

Air temp sensor







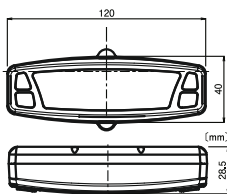









■ ASURA 



#84787



- ABS housing
- Incl. clamp for Φ22.2/25.4/31.8mm handlebars
- Incl. magnetic speed sensor

 0-399km/h or 0-250MPH	 0-20,000rpm
 0-99,999.9km (mile)	 1&2, 0-999.9km (mile)
 -10°C ~ +60°C (+14°F ~ +140°F)	 40°C ~ +200°C (+104°F ~ +392°F)
 Memory & Recall	 Memory & Recall
 12h or 24h	 Fuel Gauge
 Low Battery Warning	 Oil Changing Time Notification
    Indicators	

Option



#84851

Temp Sensor



# Compact Gauge Series

## ■ Oil Temp Meter



#89278



-9°C ~ 150°C



High/Low temp alert by Red LED backlight when higher than 120°C / lower than 5°C

- 25(W) x 42(L) x 10.8(D)mm
- White LED backlight
- Waterproof (IPX7)
- Incl. R1/8 sensor

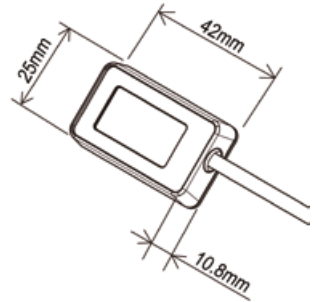

## ■ Volt Meter



#89279



7.5 ~ 18.0V



Low voltage alert by Red LED backlight when less than 12V

- 25(W) x 42(L) x 10.8(D)mm
- White LED backlight
- Waterproof (IPX7)

## ■ Wireless Hour Meter



#80072



0-999,999 hours 59minutes

- 36(W) x 57(L) x 17.3(D)mm
- No wiring connection required
- The battery included inside cannot be replaced
- Battery life approx. 4years
- Waterproof (IP68)

# NANO I

- 40(W)x60(L)x17.6(D)mm
- Without backlight
- Coin cell driven (CR2032)
- Unit detachable

## ■TEMP



#85995

- 0°C ~ +270°C (+32°F ~ +518°F) 12h
  - 0°C ~ +60°C (+32°F ~ +140°F) Memory & Recall
  - Low Battery Warning
- ※ Incl. R1/8 sensor

## ■RPM



#86719

- 0-20,000rpm
- Resettable & Non-resettable, 0-9,999.9hours
- 12h
- Memory & Recall

# NANO II

- 40(W)x60(L)x22(D)mm
- White LED backlight
- Work on DC12V
- Clamp for Φ22.2/25.4mm handlebars

## ■SPEED



#86596

- 0-399km/h or 0-250MPH
  - 0-999,999km (mile)
  - 1 & 2, 0-99,999.9km(mile)
  - 12h Memory & Recall
- ※ Incl. magnetic speed sensor

## ■GEAR



#86533

- N, 1, 2, 3, 4, 5, 6, 7, 8  
Top 4/5/6/7/8 selectable
- Bar-graph blinking

• Option accessories are on page 7

# D-Mirror-18

■ Plastic housing & stem

**NEW**



#80917  
Handlebar clamp type  
Angle adjustable  
1PC



*Easily install  
anywhere on the handlebar  
without removing parts!*

You can also use it as a bar-end mirror

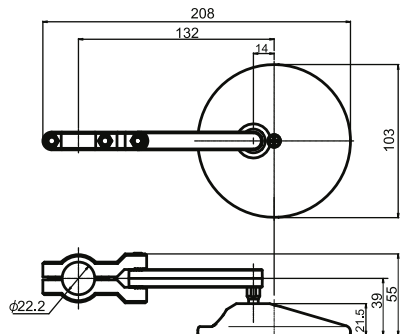

# D-Mirror-15



**NEW**

■Aluminum Housing & Stem



#80799 Bar-end type  
1PC



*Very flat housing!*  
4 ~ 6mm

# D-Mirror-16



**NEW**

■Aluminum Housing & Stem



#80800 Bar-end type  
1PC



# D-Mirror-17



**NEW**

■Aluminum Housing & Stem



#80801 Bar-end type  
1PC





# D-Mirror-13

■ABS housing & aluminum stem

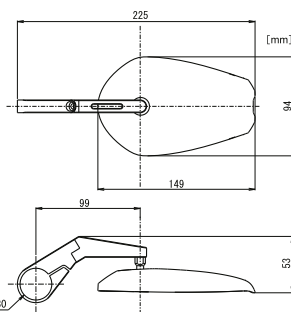

#80761  
Bar-end type (Short)  
1PC

**NEW**

# D-Mirror-14

■ABS housing & aluminum stem

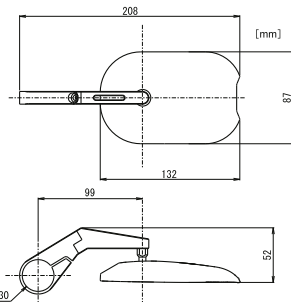

#80762  
Bar-end type (Short)  
1PC

**NEW**

# D-Mirror-3

■ Aluminum Housing & Stem



#89428  
Bar-end type  
1PC



#89429  
Standard type  
1PC

# D-Mirror-4

■ Aluminum Housing & Stem



#89430  
Bar-end type  
1PC



#89431  
Standard type  
1PC

# D-Mirror-5

## ■ Aluminum Housing & Stem



#89474  
Bar-end type  
1PC



#89475  
Standard type  
1PC

# D-Mirror-6

## ■ Aluminum Housing & Stem



#89722  
Bar-end type (Short)  
1PC



#89723  
Bar-end type (Long)  
1PC

## ■ Aluminum Housing & Steel Stem



#89724  
Standard type (Right)  
1PC



#89725  
Standard type (Left)  
1PC

# D-Mirror-7

## ■ Aluminum Housing & Stem



## ■ Aluminum housing & steel stem



#89726  
Bar-end type (Short)  
1PC



#89727  
Bar-end type (Long)  
1PC



#89728  
Standard type (Right)  
1PC



#89729  
Standard type (Left)  
1PC

# D-Mirror-8

## ■ Aluminum Housing & Stem



## ■ Aluminum housing & steel stem



#89730  
Bar-end type (Short)  
1PC



#89731  
Bar-end type (Long)  
1PC



#89732  
Standard type (Right)  
1PC



#89733  
Standard type (Left)  
1PC



# D-Mirror-9

■ABS housing & aluminum stem



■ABS housing & steel stem 



#89813  
Bar-end type (Short)  
2PCS/SET

#89814  
Bar-end type (Long)  
2PCS/SET



#89815  
Standard type  
L/R SET

# D-Mirror-10

■ABS housing & aluminum stem



■ABS housing & steel stem 



#89816  
Bar-end type (Short)  
2PCS/SET

#89817  
Bar-end type (Long)  
2PCS/SET



#89818  
Standard type  
L/R SET

# D-Mirror-11

■ABS housing & aluminum stem



#80715 LEFT (cowl type)  
#80716 RIGHT (cowl type)



#80719 LEFT  
#80720 RIGHT

# D-Mirror-12

■ABS housing & aluminum stem



#80717 LEFT (cowl type)  
#80718 RIGHT (cowl type)



#80721 LEFT  
#80722 RIGHT

# Bar-End Adapters

- CNC Aluminum
- Mount size  $\Phi 30 \times 12 \text{mm}$
- 2pcs/set

## ■ KAWASAKI



## ■ SUZUKI



## ■ YAMAHA-1



## ■ YAMAHA-2



## ■ UNIVERSAL



## ■ BMW



# Mirror Hole Plug Bolt

## ■ Adapter for HD



SIZE	RHS	LHS
RED	#99794	#99795
BLUE	#99796	#99797
GOLD	#99798	#99799
GREEN	#99800	#99801
SILVER	#99614	#99615
BLACK	#99616	#99617
TITANIUM	#99618	#99619



# Headlight

## ■CAPSULE120



- LED headlight
- Steel housing
- Dia. 120mm lens
- Front Position Lamp (ring)

### SIDE-MOUNT

- #88633 BLACK
- #88634 CHROME

[mm]

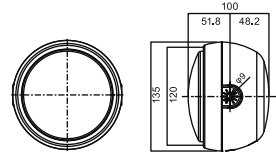

### BOTTOM-MOUNT

- #88635 BLACK
- #88636 CHROME

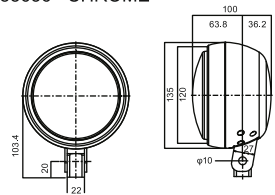

## ■NEO VINTAGE



- LED headlight
- Steel housing
- 5-3/4" (146mm) lens
- Daytime Running Light (center-bar)
- Front Position Lamp (ring)
- With a hole for  $\Phi 60$ mm gauge installation

- #88431 BLACK
- #88432 CHROME

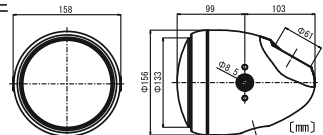

## ■VINTAGE

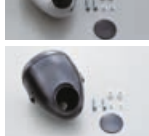

- Steel housing
- 5-3/4" (146mm) lens
- H4 12V 60/55W bulb with T10 5W position light
- With a hole for  $\Phi 60$ mm gauge installation

- #86903
- RHS, BLACK

- #86904
- RHS, CHROME

- #87357
- RHS, BLACK & BLACK



#86982  
U-shape bracket  
for installation of VELONA60



# Headlight Brackets

**NEW**

## ■Dual-axis Adjustable Type



- #80725 for  $\Phi 35\text{mm}$
- #80726 for  $\Phi 39\text{mm}$
- #80727 for  $\Phi 41\text{mm}$
- #80728 for  $\Phi 49\text{mm}$

● Material : CNC aluminum



● The fork clamp can be adjusted vertically, allowing the headlight position to be adjusted in the front-back direction.

● M8 indicator mount kit is included



## ■Modern Type

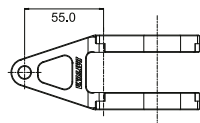

SHORT

- #88622 for  $\Phi 35\text{mm}$
- #88623 for  $\Phi 39\text{mm}$
- #88624 for  $\Phi 41\text{mm}$
- #88625 for  $\Phi 43\text{mm}$
- #88626 for  $\Phi 49\text{mm}$

● Material : CNC aluminum

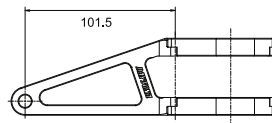

LONG

- #88617 for  $\Phi 35\text{mm}$
- #88618 for  $\Phi 39\text{mm}$
- #88619 for  $\Phi 41\text{mm}$
- #88620 for  $\Phi 43\text{mm}$
- #88621 for  $\Phi 49\text{mm}$



#88624



#88619



# LED Indicator

## ■D-Light MINI 1



#80758

- Zinc alloy body
- M8 bolt installation
- ECE approved for front and rear

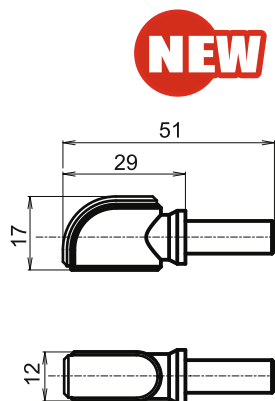

**NEW**

## ■D-Light MINI 2



#80825

- Zinc alloy body
- M8 bolt installation
- ECE approved for front and rear

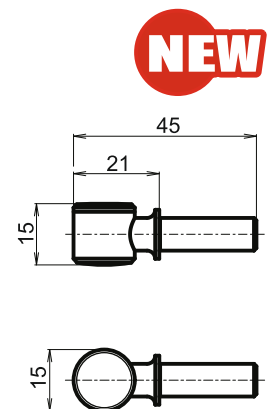

**NEW**

## ■D-Light MINI 3



#80826

- Zinc alloy body
- M8 bolt installation
- ECE approved for front and rear

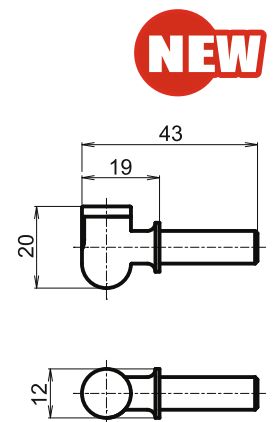

**NEW**

# Sequential LED Indicator

## ■D-Light STELLAR-2



#10000



- Aluminum body
- M8 bolt installation
- ECE approved for front and rear
- Sequential lighting

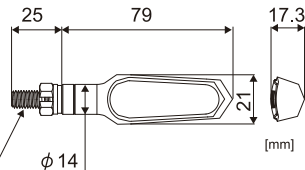

## ■D-Light STELLAR



#88266



- Aluminum body
- M8 bolt installation
- ECE approved for front and rear
- Sequential lighting

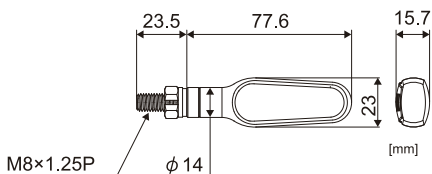

## ■D-Light RAY



#89273



- Aluminum body
- M8 bolt installation
- ECE approved for front and rear
- Sequential lighting

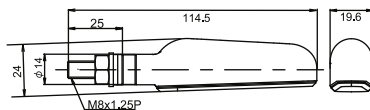

# LED Indicator

## ■D-Light SOL



#88703



#88731

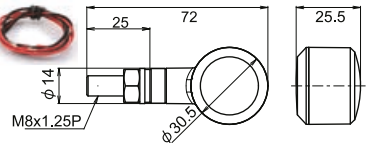

- Aluminum body
- M8 bolt installation
- ECE approved for front and rear



## ■D-Light SOL-W



#89274



#89275

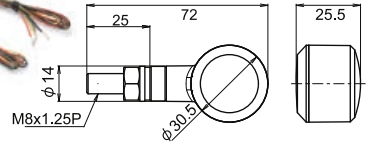

- Aluminum body
- M8 bolt installation
- ECE approved for rear indicator and stop & tail
- 3 in 1



## ■D-Light



#89232 BLACK

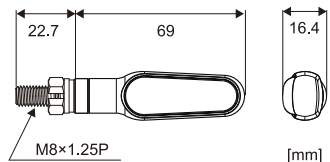

- Aluminum body
- M8 bolt installation
- ECE approved for front and rear

# Options for Direction Indicator

## ■ Fork Clamp for Indicator Mount



- For M8 indicator
- CNC aluminum
- Inside groove for discreet wiring



## ■ Mounting Plates

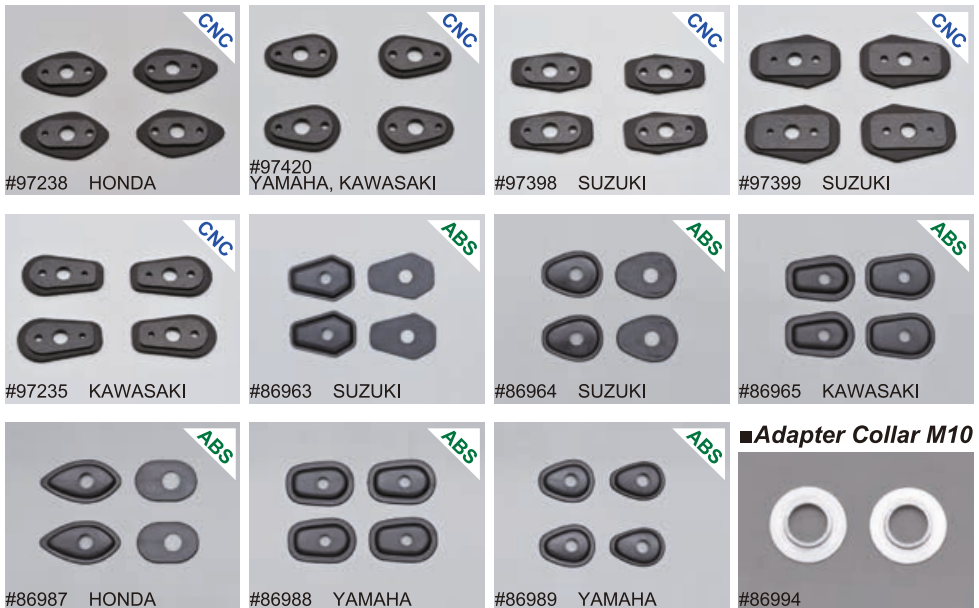

## ■ Adapter Collar M10

# IC Relay

## ■For both LED & bulb



#88985

- Power : DC8-16V (regular 12V)
- Power range : 0.1 ~ 100W
- Size : 38×28.4×17.5mm
- Flashes : 85 count/minutes
- Incl. convertible connector (2P→3P)
- CE approved

## ■For hazard & position

- Power : DC8-16V (regular 12V)
- Power range : 0.1~100W
- Size : 38×28.4×17.5mm
- Flashes : 85 count/minutes
- CE approved



#89460

## ■8P for HONDA, hazard & position & ESS



#89658

- Power : DC8-16V (regular 12V)
- Power range : 0.1~100W
- Direction flashes : 85 count/minutes
- Hazard flashes : 85 count/minutes
- ESS flashes : 220 count/minutes
- CE approved

# LED License Plate Lamp

- ECE approved



#88857

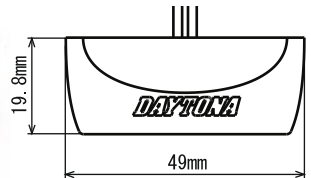

# Slim Reflector



#87192 Bolt-on



#87193 Tape-down



# ON / OFF Switch Series

## ■Slim Type

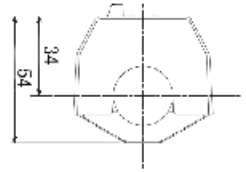

#88159 Flat Seesaw Type



#88160 Toggle Type

- Max. current 15A (12V-180W, 6V-90W)
- For  $\Phi 22.2/25.4$ mm handlebars
- Housing material: nylon
- Wire length: 800mm

## ■For H4 Headlight



#88162 Flat Seesaw Type



- Max. current 15A (12V-180W, 6V-90W)
- For  $\Phi 22.2/25.4$ mm handlebars
- Housing material: nylon
- For H4 bulb only
- Wire length: 900mm

## ■Handle Clamp Type



#71780 BLACK



#19172 YELLOW

- For  $\Phi 22.2$ mm handlebars
- Size : 50×24×20mm
- 12V/6V
- 100W
- Wire length: 1000mm
- Mounting on a flat surface using double-sided tape possible

## ■Slide Type



#71779 BLACK



#40440 YELLOW

- Size : 20×35×17mm (12V-180W, 6V-90W)
- 12V/6V
- 100W
- Wire length: 800mm

# USB Power Supply

## ■ [ TYPE-C ] series



#80399  
USB "TYPE-C" × 1port

- For USB PD (Power Delivery)
- Input : DC12V
- Output : 5V/3A, 9V/2A, 12V/1.5A
- Max : 18W
- Powers on with ignition key

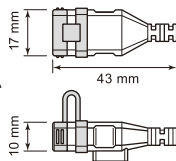

#80400  
Slim-mount USB "TYPE-C" × 1 port

- For USB PD (Power Delivery)
- Input : DC12V
- Output : 5V/3A, 9V/2A, 12V/1.5A
- Max : 18W
- For 22.2mm/ 25.4mm handlebars
- Powers on with ignition key

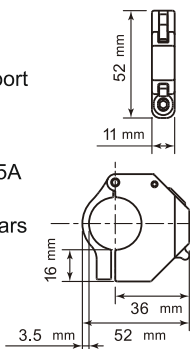

## ■ [ TYPE-A ] series



#89371  
Slim-mount USB "TYPE-A" × 1 port

- Input : DC12V
- Output : DC5V
- Rated current : 2.4A
- Housing : ABS resins
- For 22.2mm/ 25.4mm handlebars
- Powers on with ignition key



#89372  
Slim-mount USB "TYPE-A" × 2 port

- Input : DC12V
- Output : DC5V
- Rated current : 2.4A × 2 port
- Housing : ABS resins
- For 22.2mm/ 25.4mm handlebars
- Powers on with ignition key

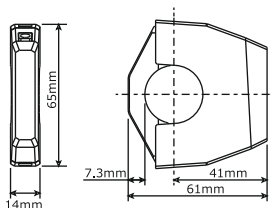



#80729  
USB "TYPE-A" × 1port

- Input : DC12V
- Output : DC5V
- Rated current : 2.4A
- Powers on with ignition key



#80730  
USB "TYPE-A" × 2 port

- Input : DC12V
- Output : DC5V
- Rated current : 2.4A × 2 port
- Powers on with ignition key

### ■ USB Cable for Motorcycle



#80468 TYPE-C to TYPE-C  
#80469 TYPE-C to Lightning  
#80470 TYPE-A to TYPE-C  
#80471 TYPE-A to Lightning

- L-shaped
- Wire length : 20cm
- 18W (5V/3A, 9V/2A, 12V/1.5A)
- #80469 & #80471 with MFi approval

### ■ Smartphone DIRECT Charging Cable



#15644 TYPE-C  
#15645 Lightning

- L-shaped
- Wire length : 800mm (from Connector to connector)
- LED lamp
- Powers on with ignition key
- #15645 with MFi approval

**POWER** DAYTONA "DIRECT" charging cable 

# Mount Bar Holder

- Creates space for smartphone, navigation, USB power supply or switch etc.
- Bar diameter 22.2mm

## ■Master Cylinder Clamp Type



- #92746 BLACK, 100mm
- #92745 CHROME, 100mm
- #77435 BLACK, 155mm
- #77434 CHROME, 155mm

## ■Master Cylinder Clamp Flat Type



- #92801 BLACK, 100mm
- #92802 CHROME, 100mm

## ■Handle Clamp Type



- #92748 BLACK, 100mm
- #92747 CHROME, 100mm
- #77437 BLACK, 155mm
- #77436 CHROME, 155mm

## ■Mirror Clamp Type



- #78031 BLACK, 100mm
- #78030 CHROME, 100mm

# Free Combination Handle Brace



Adapter bar : 50mm / 100mm



Bar : L150mm / L200mm / L250mm



Clamp

For	Bar			Clamp Φ22.2mm	Adapter bar	
	150mm	200mm	250mm		50mm	100mm
RED	#99421	#99427	#99433	#99440	#99469	#99463
BLUE	#99422	#99428	#99434	#99441	#99470	#99464
GOLD	#99423	#99429	#99435	#99442	#99471	#99465
GREEN	#99424	#99430	#99436	#99443	#99472	#99466
SILVER	#99425	#99431	#99437	#99444	#99473	#99467
BLACK	#99426	#99432	#99438	#99445	#99474	#99468



# Handlebar Bracket



- Aluminum handle clamp bracket
- For  $\Phi 22.2$ mm handlebar
- Plate 40 x 40mm
- Angle adjustable

- ABS handle clamp bracket
- For  $\Phi 22.2/25.4$ mm handlebars
- Plate 34 x 35mm

## ■ Type A

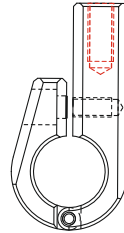
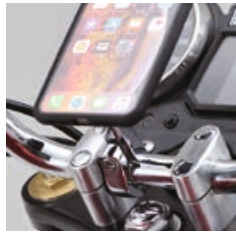

- #68452 : M8, 7/8" (22.2mm)
- #68458 : M8, 1" (25.42mm)
- #68455 : M10, 7/8" (22.2mm)
- #68461 : M10, 1" (25.42mm)

## ■ Type B

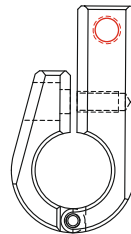

- #68453 : M8, 7/8" (22.2mm)
- #68459 : M8, 1" (25.42mm)
- #68456 : M10, 7/8" (22.2mm)
- #68462 : M10, 1" (25.42mm)

## ■ Type C

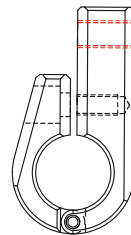
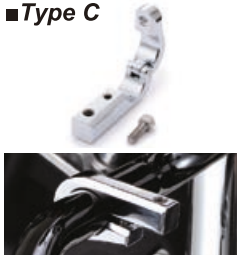

- #68454 : M8, 7/8" (22.2mm)
- #68460 : M8, 1" (25.42mm)
- #68457 : M10, 7/8" (22.2mm)
- #68463 : M10, 1" (25.42mm)



# Smartphone Holder

## ■SMARTPHONE HOLDER 3



#80218 RIGID TYPE (bolt-mount clamp)  
#80219 DETACHABLE (quick-release clamp)

- Width adjustable 55 ~ 85mm
- Length adjustable 123 ~ 170mm
- Depth for 6 ~ 18mm
- Weight for up to 300g
- Clamp for  $\Phi 22 \sim 29$ mm handlebars

DETACHABLE  
(quick-release clamp)



RIGID TYPE  
(bolt-mount clamp)

## ■SMARTPHONE HOLDER 1



#87963 RIGID TYPE (bolt-mount clamp)  
#87964 DETACHABLE (quick-release clamp)

- Width adjustable 55 ~ 85mm
- Length adjustable 110 ~ 147mm  
※using additional arm : over 153mm possible
- Depth for 6 ~ 18mm
- Weight for up to 300g
- Clamp for  $\Phi 22 \sim 29$ mm handlebars



# Heated Grips

## ■ Built-in Switch



**Built-in Switch!!**

#89820  
4-level Heat Control  
For  $\Phi 22.2\text{mm}$  ( 7/8" ) motorcycles  
Open end

★ Battery Protection

※ automatically turned off  
when voltage is less than 12V



#88640  
4-level Heat Control  
For  $\Phi 22.2\text{mm}$  ( 7/8" ) motorcycles  
Open end

Outside  
temperature 20°C

Orange

LEVEL 4

97°C (35W)

Yellow

LEVEL 3

85°C (30W)

White

LEVEL 2

67°C (21W)

Blue

LEVEL 1

52°C (14W)



**Built-in Switch!!**



■ **3-level Heat Control**



#88019  
For  $\Phi 25.4\text{mm}$  ( 1" )  
Closed end



#88020  
For Harley Davidson (96UP, 08UP)  
Closed end

■ **4-level Heat Control**



#88987  
For  $\Phi 22.2\text{mm}$  ( 7/8" )  
Open end

#88988  
For ATVs  
Open end

#86610  
For  $\Phi 25.4\text{mm}$  ( 1" )  
Closed end

■ **Spare Switch**



#86983 orange button



#89650 black button w/clamp kit

■ **2-level Heat Control**



#86607 For  $\Phi 22.2\text{mm}$  ( 7/8" )  
Closed end

#86608 For ATVs  
Closed end

#24050 Spare switch

■ **Thumb warmer**



#89875  
For ATV Heated Grips (#88988)

# Grip Warmer



#80583

- 12V
- Size : 105×95mm
- ON/OFF switch
- Wrap type

**Easy mount on grip!  
Only use when cold!**

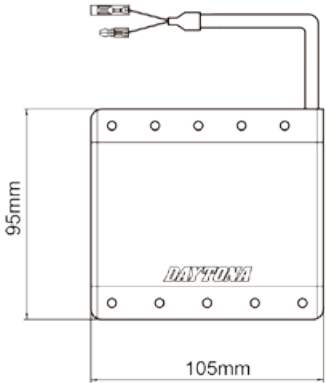



# GrippyGrip

## ■GGD-LINE [ for $\Phi 22.2\text{mm}$ ]

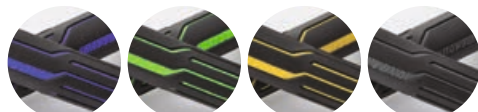

#88659  
BLUE

#88660  
GREEN

#88661  
YELLOW

#88769  
GRAY

## ■GGD-KATANA [ for $\Phi 22.2\text{mm}$ ]



#88574  
BLUE

#88575  
GREEN

#88579  
WHITE

#88576  
GRAY

## ■GGD-NAMI [ for $\Phi 22.2\text{mm}$ ]

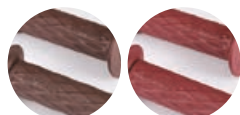

#88562  
BROWN

#88563  
DARK RED

## ■GGD-CELL [ for $\Phi 22.2\text{mm}$ ]

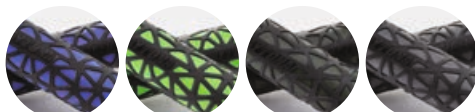

#88670  
BLUE

#88671  
GREEN

#88673  
DARK GREEN

#88672  
GRAY

## ■GGD-BASE [ for $\Phi 22.2\text{mm}$ ]

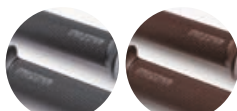

#88218  
GRAY

#88219  
BROWN

## ■GGD-SAKURA [ for $\Phi 22.2\text{mm}$ ]

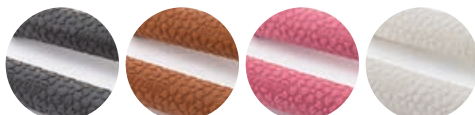

#88943  
GRAY

#88944  
CARAMEL

#88945  
PINK

#88946  
WHITE



■GGD-AMI [ for  $\Phi 22.2\text{mm}$  ]



#88569  
BLACK



#88613  
GRAY



#88570  
BROWN



#88614  
DARK BLUE



#88615  
DARK GREEN



#88571  
DARK RED



#88567  
DARK RED



#88565  
BLACK

■GGD-DELTA [ for  $\Phi 22.2\text{mm}$  ]



■GGD-KANI [ for  $\Phi 22.2\text{mm}$  ]



#88937  
BLACK



#88938  
GRAY



#88939  
BROWN

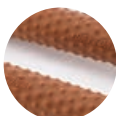

#88940  
CARAMEL

■GGD-NINJA [ for  $\Phi 22.2\text{mm}$  ]



#88663  
BLACK



#88664  
GRAY



#88665  
BROWN



#88666  
DARK RED

■GGDI-BASE [ for  $\Phi 25.4\text{mm}$  ]



#89746

■GGDI-KAWA [ for  $\Phi 25.4\text{mm}$  ]



#89747

■GGDI-ARC1 [ for  $\Phi 25.4\text{mm}$  ]



#88667

■GGDI-ARC3 [ for  $\Phi 25.4\text{mm}$  ]



#88675

■GGDI-OCTA [ for  $\Phi 25.4\text{mm}$  ]



#88674

■Grip Spacer



#80561

- Material : Neoprene
- O.D. : 50mm
- I.D. : 22 or 26mm
- Thickness : 5mm
- 2pcs/set



fills the gap ↓



■GGDM-BASE [ for  $\Phi 22.2\text{mm}$  ]

**NEW**



#80912  
BLACK & SILVER Aluminum



#80913  
BROWN & SILVER Aluminum



■GGDM-CROSS [ for  $\Phi 22.2\text{mm}$  ]

**NEW**

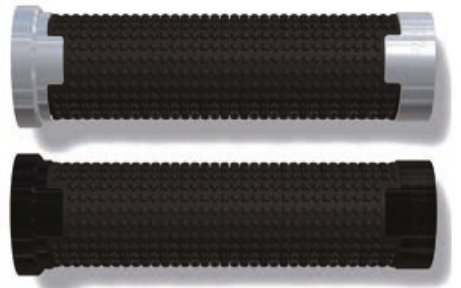

#80915  
BLACK & SILVER Aluminum



#80914  
BLACK & BLACK Aluminum



# Master Cylinder Tank Cap

■ For BMW

**NEW**



#80834



#80836



#80838

- #80834 R1250GS, R1200GS
- #80836 R1250GS, R1200GS
- #80838 R1250GS, R1200GS
- #80835 R NINE T, F850GS
- #80837 R NINE T
- #80839 R NINE T
- #80840 F850GS

- Double color anodized
- CNC Aluminum
- Use OEM diaphragm
- Patented design



■For HONDA, **MONKEY125**



- #80814 BLACK
- #80815 BLUE
- #80816 RED
- #80817 GOLD



■For HONDA, **GROM, CB650R etc.**



- #80818 BLACK



■For YAMAHA, **MT25, YZF-R25 etc.**



- #80931 BLACK
- #80932 BLUE

■For YAMAHA, **MT07, XSR900 etc.**



- #80933 BLACK
- #80934 BLUE



■For KAWASAKI Z650, Z900 etc.



#80634 GREEN



#80635 BLACK

■For NISSIN



#80636 GREEN Φ42



#80637 BLACK Φ42

■For NISSIN



SIZE	Φ38	Φ42	Φ59
RED	#92737	#92732	#92727
BLUE	#92738	#92733	#92728
GOLD	#92739	#92734	#92729
GREEN	#92740	#92735	#92730
SILVER	-	#92736	-

# Oil Filler Cap



#80638 GREEN  
M20×P2.5



#80639 BLACK  
M20×P2.5



SIZE	M20× P2.5	M24× P3.0	M30× P1.5
RED	#98399	#98405	#98423
BLUE	#98400	#98406	#98424
GOLD	#98401	#98407	#98425
GREEN	#98402	-	#98426
SILVER	#98403	#98409	#98427
BLACK	#98404	#98410	#98428



# Handlebar End Plug

**NEW**

## ■ "COMPASS"

- For I.D. 14-19mm
- Outer Diameter 30mm



#80897 RED

#80898 BLUE



#80899 SILVER

#80900 ORANGE

## ■ "TKM-2"

- For I.D. 14-19mm
- Outer Diameter 30mm
- Dual Anodizing



#87332 BLUE



#87331 RED



#88059 ORANGE

## ■ "BULLET"

- For I.D. 14-19mm
- Outer Diameter 30mm



#98374 BLACK



#80911 GUNMETAL

**NEW**  
**COLOR**

### ■“PINO-1”

- For I.D. 14-19mm
- Outer Diameter 22mm



- #99969 : RED
- #99970 : BLUE
- #99971 : CHAMPAGNE
- #99972 : GREEN
- #99973 : SILVER
- #99974 : BLACK



### ■“PINO-2”

- For I.D. 14-19mm
- Outer Diameter 22mm



- #99975 : RED
- #99976 : BLUE
- #99977 : CHAMPAGNE
- #99978 : GREEN
- #99979 : SILVER
- #99980 : BLACK



### ■“PINO-3”

- For I.D. 14-19mm
- Outer Diameter 30mm

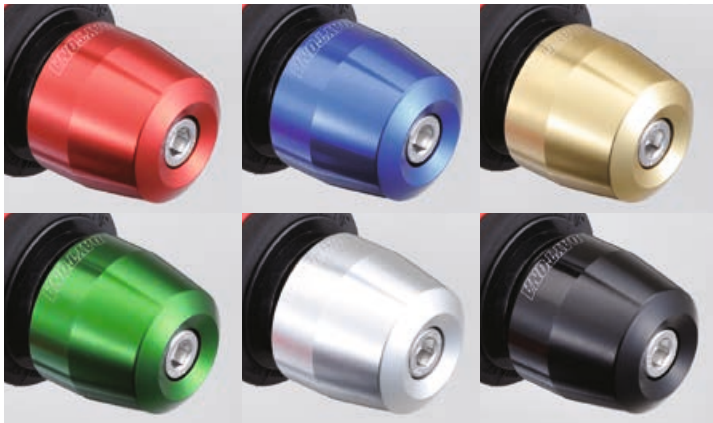

- #99981 : RED
- #99982 : BLUE
- #99983 : CHAMPAGNE
- #99984 : GREEN
- #99985 : SILVER
- #99986 : BLACK



# HenlyBegins Seat Bag

※HenlyBegins is a brand owned by Daytona Japan.



- |          |               |  |                          |                            |
|----------|---------------|--|--------------------------|----------------------------|
| ① #96719 | <b>DH-717</b> | <input type="text" value="20 ~ 26 l"/> | W(300 ~ 400)×D290×H200mm | Loading weight 7kg, Black  |
| ② #96720 | <b>DH-718</b> | <input type="text" value="33 ~ 42 l"/> | W(490 ~ 610)×D275×H225mm | Loading weight 8kg, Black  |
| ③ #96721 | <b>DH-719</b> | <input type="text" value="44 ~ 60 l"/> | W(410 ~ 570)×D320×H300mm | Loading weight 10kg, Black |
| ④ #97980 | <b>DH-724</b> | <input type="text" value="53 ~ 70 l"/> | W(525 ~ 685)×D320×H300mm | Loading weight 14kg, Black |

● Polyester ● Incl. rain cover ● Expandable

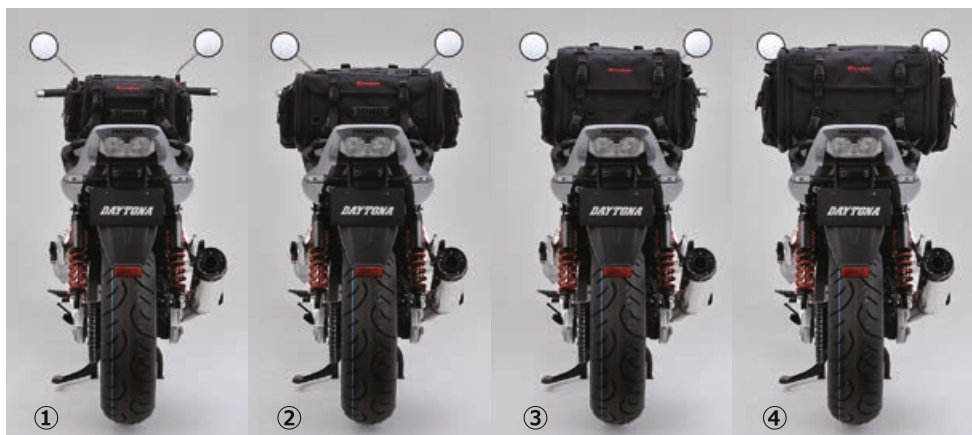



**NEW**



- ① #29783 **DH-762** 20 ~ 26 l W(300 ~ 400)×D300×H200mm Loading weight 7kg, Khaki
- ② #29784 **DH-763** 33 ~ 42 l W(490 ~ 610)×D275×H225mm Loading weight 8kg, Khaki
- ③ #29785 **DH-764** 44 ~ 60 l W(410 ~ 570)×D320×H300mm Loading weight 10kg, Khaki
- ④ #29786 **DH-765** 53 ~ 70 l W(525 ~ 685)×D320×H300mm Loading weight 14kg, Khaki

● Polyester ● Incl. rain cover ● Expandable

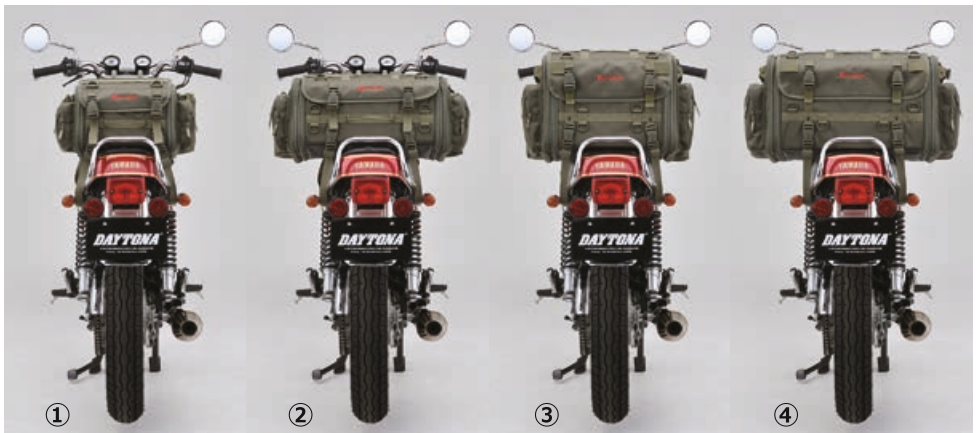



#19437

**DH-747** **5.5 ℓ**

- W220×D295×H165mm
- PC & Polyester
- Incl. rain cover
- Loading weight 5.5kg



#95741 (BLACK)  
 #95734 (CARBON × BLACK)  
 #95735 (RED)

**DH-708** **4 ℓ**

- W250×D285×H110mm
- Artificial leather & Polyester
- Incl. rain cover
- Loading weight 5kg



#97087

**DH-723** **6 ℓ**

- W250×D300×H185mm
- Artificial leather & Polyester
- Incl. rain cover
- Loading weight 5kg



#96043

**DH-710** **7 ℓ**

- W235×D280×H145mm
- Artificial leather & Nylon
- Incl. rain cover
- Loading weight 5kg



#97241

**DH-722** **7~12 ℓ**

- W250×D345×H(150~220)mm
- Polyester • Expandable
- Incl. rain cover
- Incl. shoulder strap
- Loading weight 5kg



#98661

**DH-731** **13~26 ℓ**

- W280×D345×H(190~310)mm
- Polyester • Expandable
- Incl. rain cover
- Incl. shoulder strap
- Loading weight 5kg







#21773

**DH-751** **20 L**

- W440×D300×H170mm
- Polyester
- Incl. rain cover
- Loading weight 5kg



#20042 (BLACK)

#20043 (GRAY)

#20049 (RED)

**DH-749** **60 L**

- W550×D330×H350mm
- Tarpaulin Fabric
- Loading weight 14kg
- Waterproof

## Backpack



**NEW**



#20030 (BLACK)

#20031 (GRAY)

#20032 (RED)

**DH-748** **30 L**

- Φ300×L450mm
- Tarpaulin Fabric
- Loading weight 7kg
- Waterproof
- Need optional fixing belt(#15383) to be used as seat bag



# HenlyBegins Saddle Bag

※HenlyBegins is a brand owned by Daytona Japan.



① #96906	<b>DHS-1</b>	9 ℓ	W360×D130×H200mm	Loading weight 5kg
② #96907	<b>DHS-2</b>	12 ℓ	W360×D120×H270mm	Loading weight 5kg
③ #18994	<b>DHS-18</b>	13 ℓ	W280×D170×H300mm	Loading weight 5kg
④ #96909	<b>DHS-4</b>	18 ℓ	W400×D150×H300mm	Loading weight 5kg
⑤ #18996	<b>DHS-19</b>	22 ℓ	W430×D160×H320mm	Loading weight 5kg

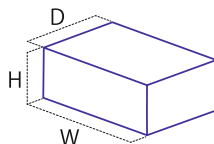

● Artificial leather & Polyester ● Incl. rain cover



#24364 **DHS-21** 12 ℓ  
 W360×D120×H270mm Loading weight 5kg  
 ● Artificial leather & Polyester ● Incl. rain cover



#90557 **DHS-13** 10 ℓ W350×D100×H280mm

#99702 **DHS-10** 15 ℓ W365×D135×H320mm

● Polyester



Loading weight 2kg

Loading weight 2kg

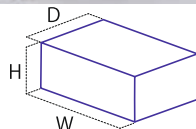

#99703 **DHS-11** 20 ℓ W350×D100×H280mm

#99704 **DHS-12** 30 ℓ W360×D140×H315mm

● Polyester



Loading weight 2kg each

Loading weight 2kg each



#21774 **DHS-20** 10 ℓ W360×D120×H270mm

Loading weight 2kg

● Polyester



# HenlyBegins Tool Bag

※HenlyBegins is a brand owned by Daytona Japan.



#98771 **DHS-7** 1.5 ℓ W250×D75×H105mm Loading weight 1.5kg

#98773 **DHS-8** 2 ℓ W255×D65×H130mm Loading weight 1.5kg

● Polyester

## Under-seat Storage Pocket for Scooters



#93000  
SMALL (250x320)



#93001  
MEDIUM (270x320)



#93002  
LARGE (270x400)

- For scooters
- Installation with tapping screws
- Storable weight 1kg





# Connector & Terminal Set



## TYPE110

- #96167 (2-pole)
- #96168 (3-pole)
- #96169 (4-pole)
- #96170 (6-pole)
- #96171 (9-pole)

#96167



## TYPE250

- #96172 (2-pole)
- #96173 (3-pole)
- #96174 (4-pole)
- #96175 (6-pole)

#96172



## TYPE HM

- #96182 (2-pole)
- #96183 (3-pole)
- #96184 (4-pole)
- #96185 (6-pole)

#96182



## TYPE HM [waterproof]

- #96176 (2-pole)
- #96177 (3-pole)
- #96178 (4-pole)
- #96179 (6-pole)

#96176



## TYPE MT [waterproof]

- #96180 (3-pole)
- #96181 (4-pole)

#96180

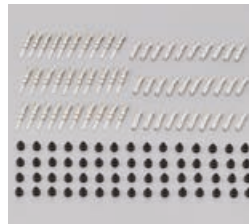

## Terminal Set for HM/MT waterproof connector

- Male terminal x 30
- Female terminal x 30
- Wire seal x 60

#96303



## Bullet Terminal Set

- TYPE CA/CB103
- #96153 Set of 30
- #96155 Set of 5

- TYPE CA/CB104
- #96156 Set of 30
- #96157 Set of 5

- For KAWASAKI
- #96158 Set of 30

#96153



## Bullet Terminal Set [waterproof]

- TYPE CA/CB103
- #41220 Set of 20
- #61938 Set of 5

- TYPE CA/CB104
- #41221 Set of 20
- #61939 Set of 5

#41220



## Connector Set TYPE 250 [Reverse Lock]

- #96187 (2-pole)
- #96188 (3-pole)
- #96189 (4-pole)
- #96190 (6-pole)

#96187



## Connector Set for H4 Bulb

- TYPE H4
- male connector x 1
- female connector x 1

- TYPE 305
- male terminal x 3
- female terminal x 3

#96186



## ■Connector Set for Turn Signal



#96191 (2-pole)  
HONDA-A  
LIGHT BLUE



#96192 (2-pole)  
HONDA-A  
ORANGE



#96300 (2-pole)  
HONDA-B  
LIGHT BLUE



#96301 (2-pole)  
HONDA-B  
ORANGE



#96302 (3-pole)  
HONDA-B  
WHITE



#96193 (2-pole)  
SUZUKI  
BLACK



#96194 (2-pole)  
SUZUKI  
GRAY



#96195 (2-pole)  
SUZUKI  
WHITE



#96199 (2-pole)  
KAWASAKI  
BLACK



#96200 (2-pole)  
KAWASAKI  
GRAY



#15414 (2-pole)  
KAWASAKI  
TYPE 040-HX series

## ■Connector Cover Boot



#96206  
Φ8xΦ22x70  
  
#96207  
Φ16xΦ37x84  
  
#96208  
Φ27xΦ42x84

# OEM-colored wire

## ■SQ 0.75 (14A/12V) x 2M

#93181 RED	#93182 BLACK
#93183 GREEN	#93184 LIGHT BLUE
#93185 ORANGE	#93186 BLUE
#93187 WHITE	#93188 YELLOW
#93189 GREEN/ YELLOW	#93190 BROWN
#93191 LIGHT GREEN	#93192 BLACK/ WHITE
#93193 WHITE/ BLACK	#93194 GRAY
#93195 BLACK/ YELLOW	#93196 RED/ BLACK
#93197 RED/ YELLOW	#93198 BLACK/ BROWN
#93199 ORANGE/ WHITE	
#93200 LIGHT BLUE/ WHITE	

## ■SQ 1.25 (20A/12V) x 1M

#93201 RED #93203 BLACK

#93202 GREEN



## ■SQ 2.0 (26A/12V) x 1M

#93204 RED #93206 BLACK

#93205 GREEN



## ■SQ 0.5 (11A/12V) x 2M

#65097 RED #65098 BLACK

#65099 GREEN

Color	Brand	Usage
RED	UNIVERSAL	
BLACK		
GREEN		
LIGHT BLUE	HONDA	Winker (Right)
ORANGE	HONDA	Winker (Left)
BLUE	HONDA	Headlight (High Beam)
WHITE	HONDA	Headlight (Low Beam)
YELLOW	YAMAHA	Headlight (High Beam), Taillight
GREEN/YELLOW	HONDA	Taillight
BROWN	YAMAHA	ACC Wire
LIGHT GREEN	SUZUKI	Winker (Right)
BLACK/WHITE	SUZUKI	GND Wire
WHITE/BLACK	SUZUKI	Taillight
GRAY	KAWASAKI	Winker (Right)
BLACK/YELLOW	KAWASAKI	GND Wire
RED/BLACK	HONDA	ACC Wire
RED/YELLOW	KAWASAKI	Headlight (High Beam)
BLACK/BROWN	KAWASAKI	Headlight (Low Beam)
ORANGE/WHITE	HONDA	ACC Wire
LIGHTBLUE/WHITE	HONDA	Position Light

# Fuel Hose (1M)

## ■2-layered Fuel Hose



- #96460 Φ4xΦ8, 1M
- #96461 Φ5xΦ10, 1M
- #96462 Φ6xΦ10, 1M
- #96463 Φ8xΦ13, 1M
- #96464 Φ10xΦ15, 1M

- 2-layered
- Pressure capacity 1.0MPa
- Heatproof temperature 100°C
- Incl. 5pcs of clip

- ※ Not for brake fluid
- ※ Not for FI models

## ■Hose Clamp



- |            |                   |
|------------|-------------------|
| #91238 Φ6  | #91244 Φ12        |
| #91239 Φ7  | #91245 Φ13        |
| #91240 Φ8  | #91246 Φ14        |
| #91241 Φ9  |                   |
| #91242 Φ10 | ● 2pcs / set      |
| #91243 Φ11 | ● Material: Steel |

## ■Hose Clip



- |            |                   |
|------------|-------------------|
| #91420 Φ6  | ● 10pcs / set     |
| #91422 Φ8  | ● Material: Steel |
| #91423 Φ9  |                   |
| #91424 Φ11 |                   |
| #91425 Φ13 |                   |
| #91426 Φ15 |                   |

## ■Fuel Hose Stopper



- #91110
- For hose outer diameter up to 15mm
- ※ Not for negative pressure cock
- ※ Not for FI models

# Front Lever Lock



- #97636 (ORANGE)
- #97637 (BLACK)
- #97638 (GREEN)
- #97639 (RED)

Grip mount type  
I.D. 36mm

# Seat Repair Sticker

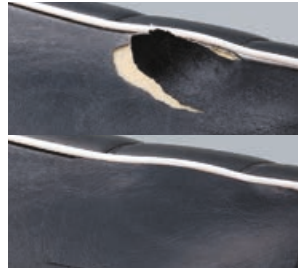

84705 (M-BLACK)  
84708 (BLACK)  
84706 (M-BROWN)  
84709 (BROWN)  
84707 (M-BEIGE)  
84710 (BEIGE)

110x170mm  
※ M-▶matte

# Protection Sticker

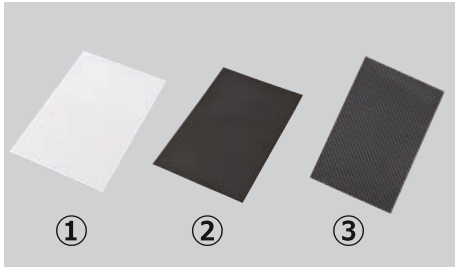

① #69803  
(CLEAR)  
② #69816  
(BLACK)  
③ #79283  
(CARBON TYPE)

130x200mm

# Anti-slip Sticker

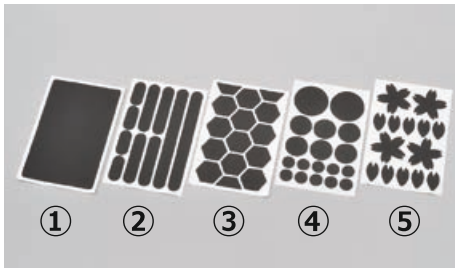

① #17381  
(PLAIN)  
② #17391  
(SLOT)  
③ #17389  
(HONEYCOMB)  
④ #17390  
(ROUND)  
⑤ #17379  
(SAKURA)

# License Number Plate Holder (Germany)

#89854

- Aluminum
- Anodized black
- For German number plate 180x200



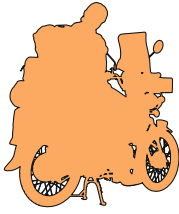

# Information



For more information,  
please visit the following website / Instagram.



Go to website

<https://daytona-europe.com>

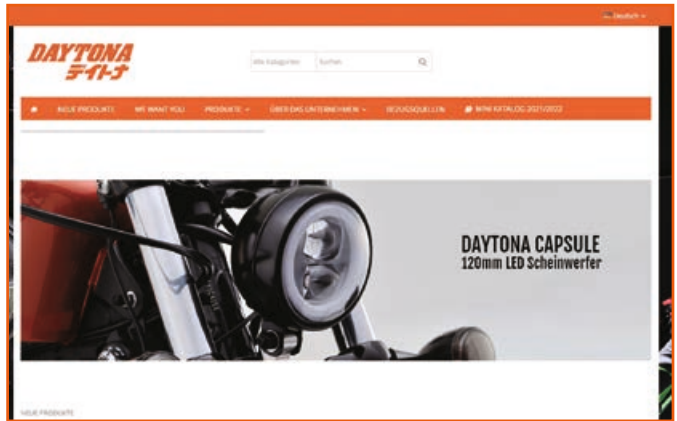

Go to Instagram

[https://www.instagram.com/daytona\\_europe/](https://www.instagram.com/daytona_europe/)

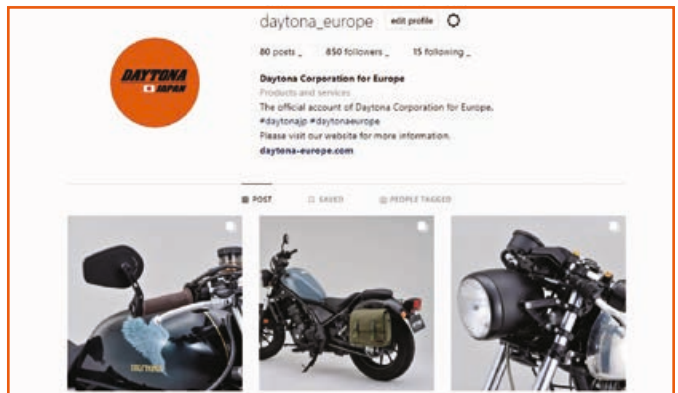



FOCUS OPEN 2021  
INTERNATIONALER DESIGNPREIS  
BADEN-WÜRTTEMBERG



HI-RETRO TECH KIT  
MOTO UPGRADE

**DAYTONA**



FOCUS OPEN 2021  
Special Mention

**DAYTONA**

<https://daytona-europe.com>