

## HIGHSIDER - STAY TRUE. STAY RED.

Leidenschaft macht keine Kompromisse - Leidenschaft weckt Emotionen!

Seit über 10 Jahren vereint uns die Liebe zu Motorrädern. Und wir lieben es, mit unseren Produkten Ihrem Motorrad einen unverwechselbaren Stil zu geben. Deshalb streben wir Tag für Tag nach Verbesserung. Von unseren Spiegel-, Scheinwerfer- oder Blinker / Rücklicht-Serien bis hin zu kleinen Zubehörteilen wie Lenkergewichte, Lenkergriffe oder Lampenhalter - unser Anspruch lautet stets, unsere Produkte mit modernster und effizienter Technik sowie einem Höchstmaß an Qualität, Funktionalität und innovativem Design anzubieten.

Auf den folgenden Seiten finden Sie eine Auswahl unseres Produktsortimentes. Lehnen Sie sich zurück und lassen Sie sich inspirieren.

STAY TRUE. STAY RED.









# INHALTSVERZEICHNIS

▪ Scheinwerfer .....	7-48
▪ Blinker .....	49-70
▪ Rücklichter .....	71-76
▪ Spiegel.....	77-105
▪ Kennzeichenhalter .....	107-111
▪ Riser und Gewichte .....	112-118
▪ Griffe .....	119
▪ Abdeckkappen, Deckel und Einschweissgehäuse .....	120-123
▪ Hebelschützer .....	124
▪ Instrumente .....	126-127
▪ Abdeckplanen .....	128-129

## SYMBOLE

 <b>LED</b>	In diesem Produkt ist LED-Technik verbaut.
 <b>≡D≡</b>	Standlicht
 <b>≡D</b>	Fernlicht
 <b>≡D</b>	Abblendlicht
 <b>TFL</b>	Tagfahrlicht
 <b>⊘D</b>	Nebellicht

	Kurvenlicht
	Rücklicht
	Bremslicht
	Kennzeichenbeleuchtung
 <b>COB</b>	Chip-on-Board-Technik
 <b>L+R</b>	Dieser Spiegel kann links und rechts verwendet werden.

	Blinker
	Rücklicht-Blinker
	Blinker-Positionslicht
	Positionslicht
	Hinweis Tutorials





Du brauchst Tipps und Tricks? Dann achte einfach auf dieses Icon.  
Scanne den QR-Code ein und du kommst auf unseren Youtube  
Channel auf dem Paul und Frank Euch einige Tipps und Tricks geben.







— SCHEINWERFER —

# FLAT TYP 9



MIT STANDLICHTRING

4 3/4  
ZOLL



223-194



223-193



279,95 €  
UVP pro Stück

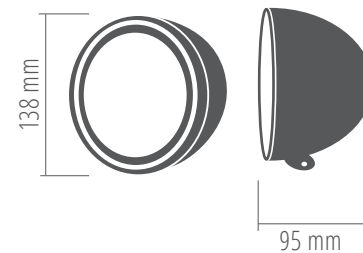

Beleuchtungsbeispiele



**HIGHSIDER™**  
POWERED BY PAASCHBURG & WUNDERLICH



# FLAT TYP 9



MIT STANDLICHTRING

4 3/4  
ZOLL



223-196



279,95 €  
UVP pro Stück

Beleuchtungsbeispiele

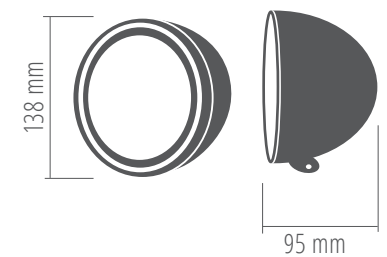

# JACKSON



5 3/4  
ZOLL



223-029

359,95 €  
UVP pro Stück



223-028

Beleuchtungsbeispiel:  
Abblendlicht



Beleuchtungsbeispiel:  
Standlicht

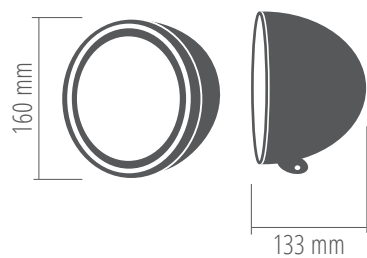



5 3/4  
ZOLL

JACKSON



359,95 €  
UVP pro Stück



223-026

223-027

Beleuchtungsbeispiel:  
Abblendlicht



Beleuchtungsbeispiel:  
Standlicht

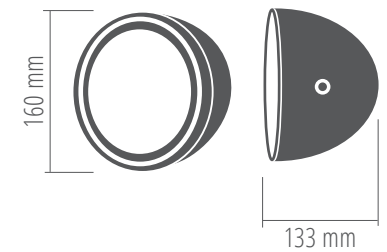

# CIRCLE



MIT STANDLICHTRING & TAGFAHRLICHTRING

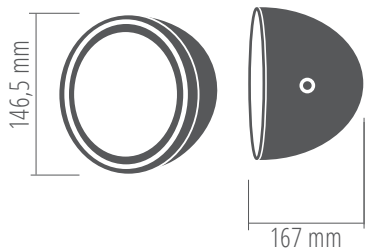

Beleuchtungsbeispiel:  
Standlicht



299,95 €  
UVP pro Stück

5 3/4  
ZOLL



223-047



223-046

# CIRCLE



MIT STANDLICHTRING & TAGFAHRLICHT

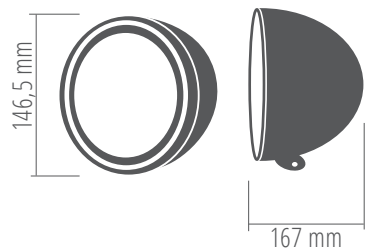

Beleuchtungsbeispiel:  
Standlicht



299,95 €  
UVP pro Stück

5 3/4  
ZOLL



223-049



223-048



## BATES STYLE TYP 5



223-213

5 3/4  
ZOLL

299,95 €  
UVP pro Stück



223-214

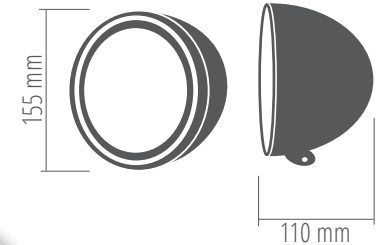

223-217

5 3/4  
ZOLL

299,95 €  
UVP pro Stück



223-215



223-218

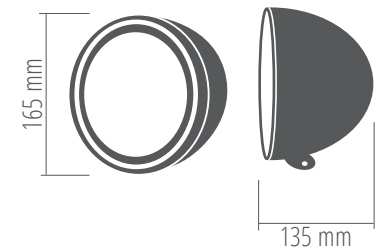

## PECOS TYP 6



MIT TAGFAHRLICHT

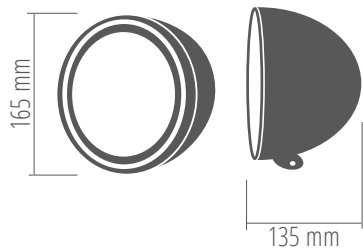

299,95 €  
UVP pro Stück



Beleuchtungsbeispiel:  
Standlicht & Tagfahrlicht



5 3/4  
ZOLL

## PECOS TYP 7



MIT STANDLICHRING

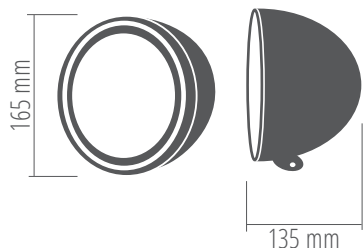

299,95 €  
UVP pro Stück



Beleuchtungsbeispiel:  
Standlicht



5 3/4  
ZOLL

5 3/4  
ZOLL



223-001

299,95 €  
UVP pro Stück



223-002

- LED
- Stück
- Metall
- EDGE
- ED
- ED
- e

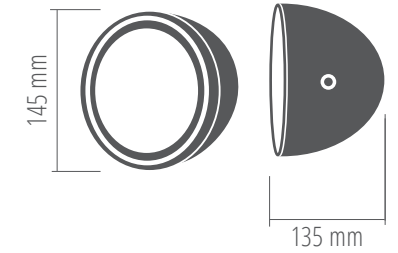

## ATLANTA

5 3/4  
ZOLL



223-003

299,95 €  
UVP pro Stück



223-004

- LED
- Stück
- Metall
- EDGE
- ED
- ED
- e

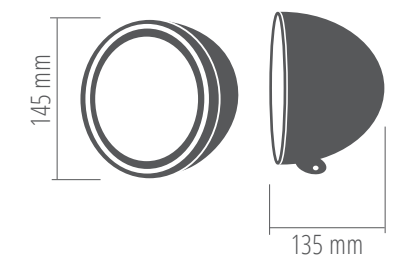

## ATLANTA



# YUMA 2 TYP 3



7  
ZOLL

329,95 €  
UVP pro Stück

223-231



223-230

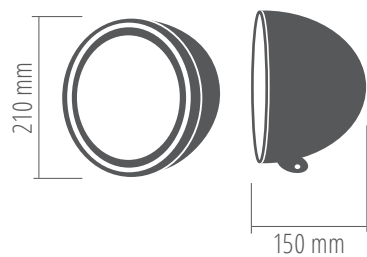



7  
ZOLL

# YUMA 2 TYP 4



MIT TAGFAHRLICHT

349,95 €  
UVP pro Stück



223-233

223-234



Beleuchtungsbeispiel:  
Standlicht & Tagfahrlicht

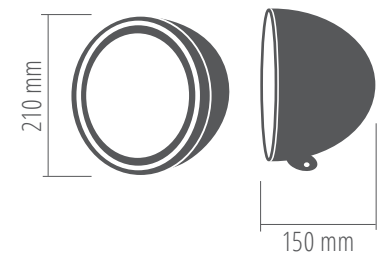

# YUMA 2 TYP 8



MIT TAGFAHRLICHT & KURVENLICHT



499,95 €  
UVP pro Stück



klares Glas, 223-244



getöntes Glas, 223-243

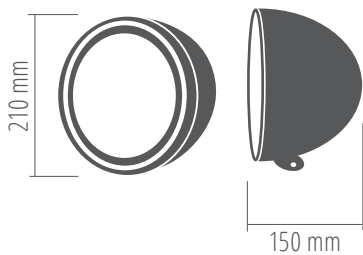

Beleuchtungsbeispiel:  
Standlicht & Tagfahrlicht





# LTD TYP 8

7  
ZOLL



MIT TAGFAHRLICHT & KURVENLICHT

499,95 €  
UVP pro Stück



223-237



223-238



Beleuchtungsbeispiel:  
Standlicht & Tagfahrlicht

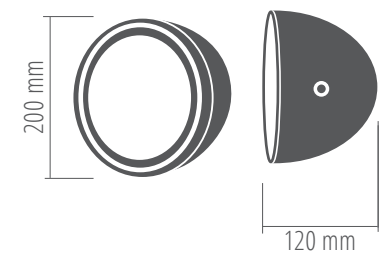

7  
ZOLL



223-132



223-133



223-134

499,95 €  
UVP pro Stück

## RENO TYP 1

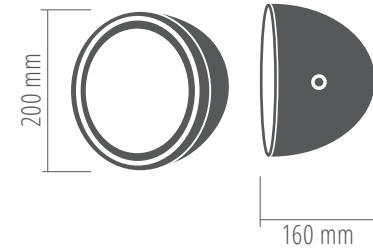

499,95 €  
UVP pro Stück

7  
ZOLL



223-143



223-142



## RENO TYP 2

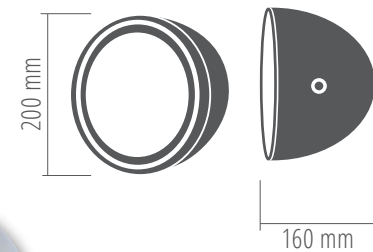

## RENO TYP 3

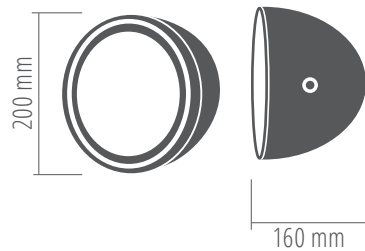

223-146

299,95 €  
UVP pro Stück



223-147

7  
ZOLL

## RENO TYP 4



MIT TAGFAHRLICHT

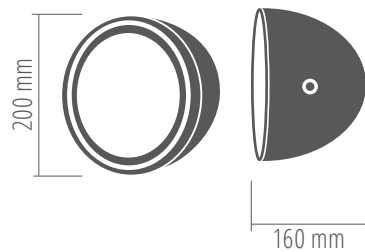

223-152

319,95 €  
UVP pro Stück



223-153

7  
ZOLL



7  
ZOLL



223-183

499,95 €  
UVP pro Stück



223-178

## HD-STYLE TYP 1

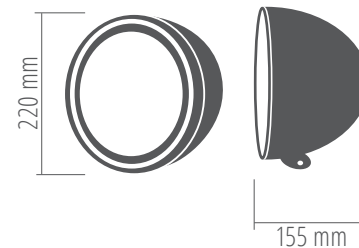

223-185

499,95 €  
UVP pro Stück

7  
ZOLL



223-184

## HD-STYLE TYP 2

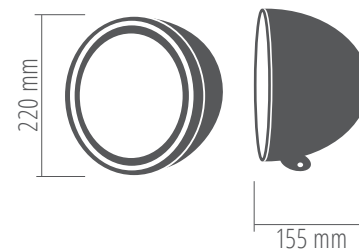

## HD-STYLE TYP 3

7  
ZOLL

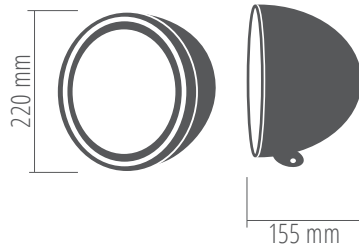

223-148

329,95 €  
UVP pro Stück



223-149

## HD-STYLE TYP 4

7  
ZOLL



MIT TAGFAHRLICHT

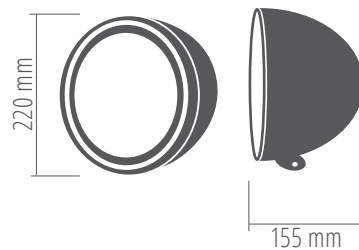

223-154

319,95 €  
UVP pro Stück



223-155

# HD-STYLE TYP 8



MIT TAGFAHRLICHT & KURVENLICHT

7  
ZOLL



223-240

499,95 €  
UVP pro Stück



223-243

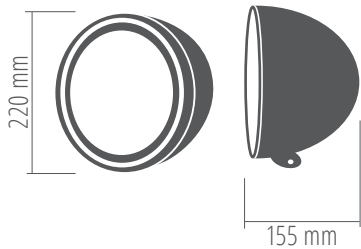

Beleuchtungsbeispiel:  
Standlicht & Tagfahrlicht





# BRITISH-STYLE TYP 8



MIT TAGFAHRLICHT & KURVENLICHT

7  
ZOLL

499,95 €  
UVP pro Stück



223-236



223-235

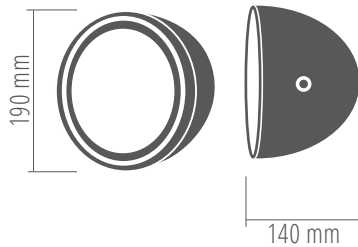

Beleuchtungsbeispiel:  
Standlicht & Tagfahrlicht



# VOYAGE



223-161

369,95 €  
UVP pro Stück

7  
ZOLL



223-160



Beleuchtungsbeispiel

- LED
- Stück
- Metall
- EDGE
- LED
- LED
- e

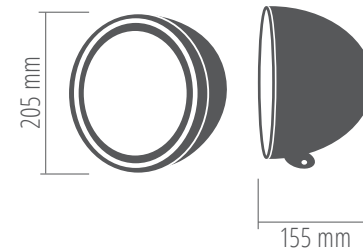

223-163

369,95 €  
UVP pro Stück

7  
ZOLL



223-162

# VOYAGE

- LED
- Stück
- Metall
- EDGE
- LED
- LED
- e

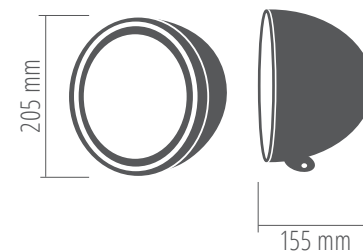

# VOYAGE HD-STYLE



369,95 €  
UVP pro Stück



223-164



223-165

Beleuchtungsbeispiel:  
Standlicht

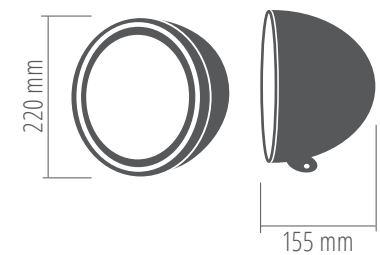

**HIGHSIDER™**  
POWERED BY PAASCHBURG & WUNDERLICH





# ULTIMATE

LOW



Beleuchtungsbeispiel

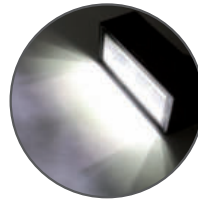

223-082

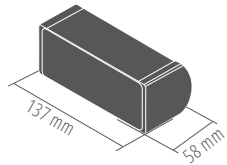

Zur unteren und seitlichen Befestigung

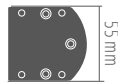

MIT Z-HALTER



223-084

349,95 €  
UVP pro Set

Modernes,  
markantes  
Design!

Beleuchtungsbeispiel



HIGH



223-083

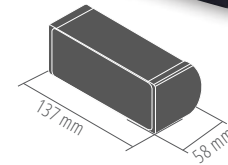

Zur unteren und seitlichen Befestigung

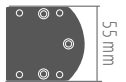

MIT WAVE-HALTER



223-085

369,95 €  
UVP pro Set



## DUAL STREAM



223-454

169,95 €  
UVP pro Stück

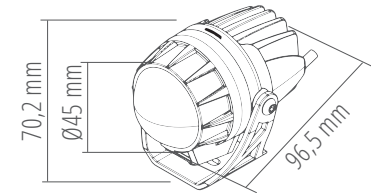

Kleiner vollwertiger  
Scheinwerfer -  
hohe Lichtausbeute!



Abblendlicht



FFernlicht



Beleuchtungsbeispiel



# SATELLITE

Fernscheinwerfer

99,95 €  
UVP pro Stück

Abblendscheinwerfer

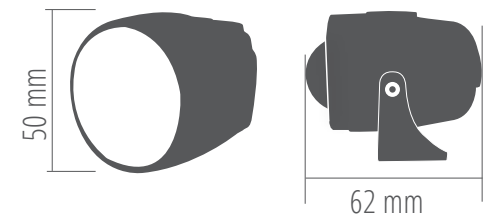
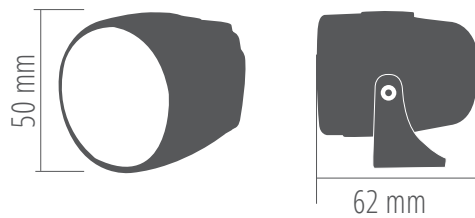

# COMET

LOW

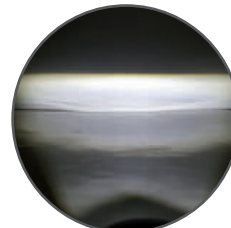
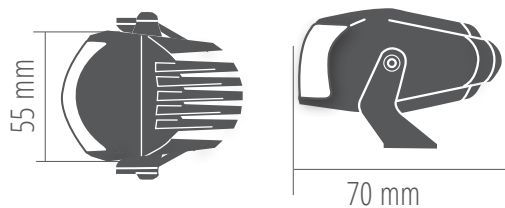

Beleuchtungsbeispiel

119,95 €  
UVP pro Stück

223-451

HIGH



119,95 €  
UVP pro Stück

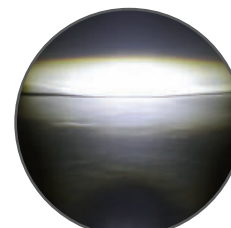

Beleuchtungsbeispiel

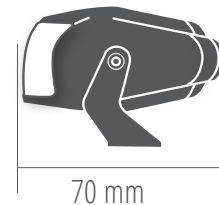
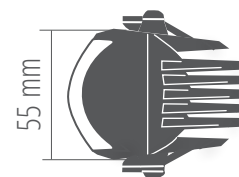

223-452



109,95 €  
UVP pro Stück

5 3/4  
Zoll

SKYLINE

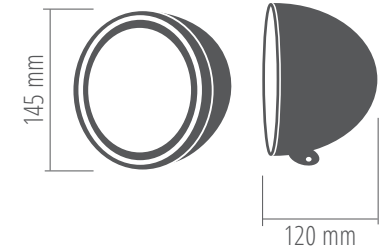

223-024

223-025

Beleuchtungsbeispiel



5 3/4  
Zoll



109,95 €  
UVP pro Stück

SKYLINE

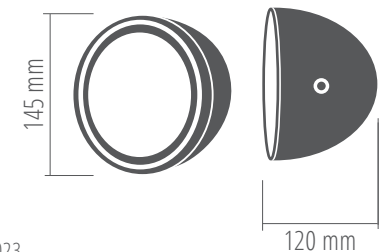

223-022

223-023



# CLASSIC 3



223-038

4 1/2  
ZOLL



223-037

159,95 €  
UVP pro Stück

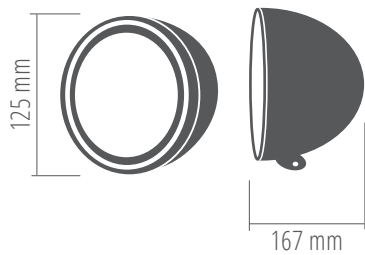

inkl. Adapter zur Befestigung

HIGHsider™  
POWERED BY PAASCHBURG & WUNDERLICH

# CLASSIC 1

ab 179,95 €  
UVP pro Stück

5 3/4  
ZOLL



223-033



223-034



223-032

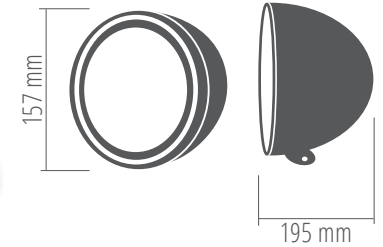

+ 25 mm für den Schirm  
inkl. Adapter zur Befestigung

# CLASSIC 1

ab 179,95 €  
UVP pro Stück

5 3/4  
ZOLL



223-031



223-030

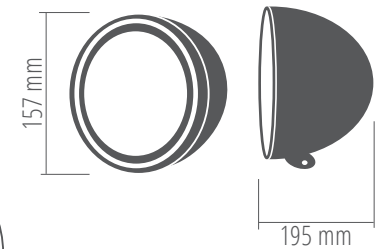

+ 25 mm für den Schirm

# IOWA



99,95 €  
UVP pro Stück

223-064



223-063

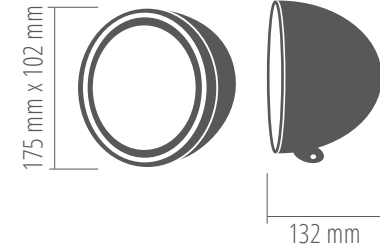

# IOWA



99,95 €  
UVP pro Stück

223-062



223-060

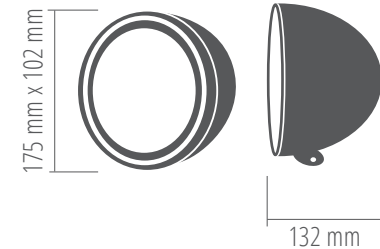



OREGON

159,95 €  
UVP pro Stück



223-058

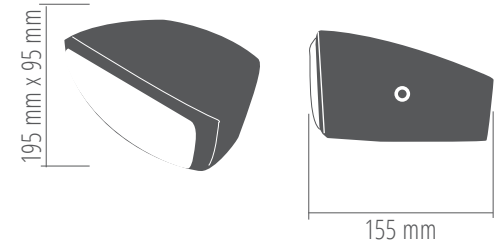

OREGON

159,95 €  
UVP pro Stück



223-056



223-055

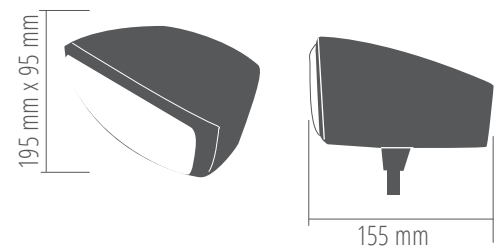



220-652

## UB 1 SCHEINWERFER SET

Dieses Scheinwerfer Set gibt es in verschiedenen Varianten. Je nach Durchmesser bieten wir verschiedene Sets an: 35-37 mm (Art.Nr. 220-652), 38-41 mm (Art.Nr.220-654), 42-43 mm (Art.Nr. 220-658), 50-54 mm (Art.Nr. 220-668). Ein Set beinhaltet wie z.B. 220-652: 1 Paar Schellen (Art.Nr. 207-402) mit Reduzierstreifen, 1 Halterpaar UB1 (Art.Nr. 220-830) und 1 x URBAN Scheinwerfer (Art.Nr. 223-110).



229,95 €  
UVP pro Stück



223-110

## URBAN

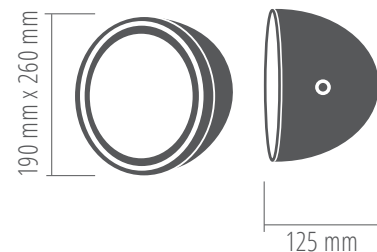

119,95 €  
UVP pro Stück

Es müssen gegebenenfalls Schellen (je nach Standrohrdurchmesser, s.o.) sowie Halter (Art.Nr. 220-830) dazu bestellt werden.







## LED-MICRO NEBELSCHEINWERFER



79,95 €  
UVP pro Stück

222-200

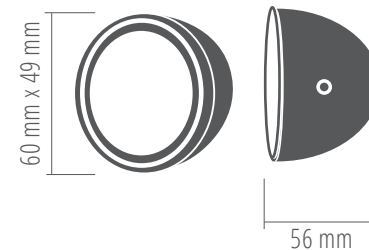

## LED-NEBELSCHEINWERFER



79,95 €  
UVP pro Stück

222-201

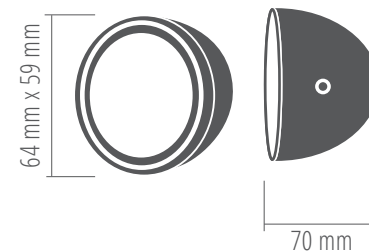



99,95 €  
UVP pro Stück

## NEBELSCHEINWERFER

MIT HIGH POWER LED.

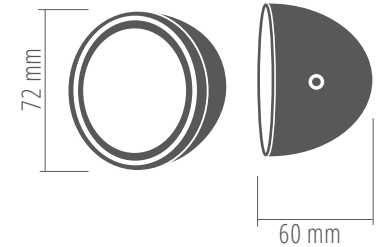

222-203

## LED-TAGFAHRLICHT

MIT 4 LEDS.



44,95 €  
UVP pro Stück

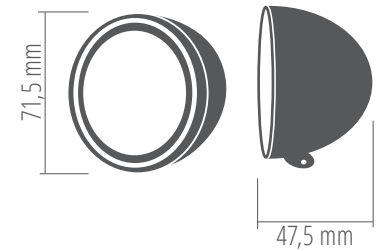

222-502

## LED-TAGFAHRLICHT

MIT 4 POWER-LEDS.



44,95 €  
UVP pro Stück



222-500

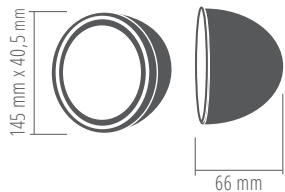

## LED-TAGFAHRLICHT

MIT 4 POWER-LEDS UND STANDLICHT.



49,95 €  
UVP pro Stück



222-501

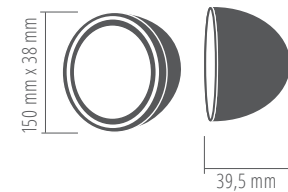

## LED POSITIONSLEUCHE GLOW-PL1

MIT STARK HAFTENDER KLEBEFOLIE

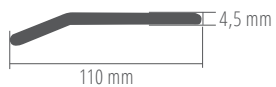

223-300

79,95 €  
UVP pro Paar



Beleuchtungsbeispiel



## TAGFAHRLICHT PENTA

INKL. ELEKTRONIKBOX FÜR AUTOMATISCHES UMSCHALTEN VON POSITIONS- UND TAGFAHRLICHT.

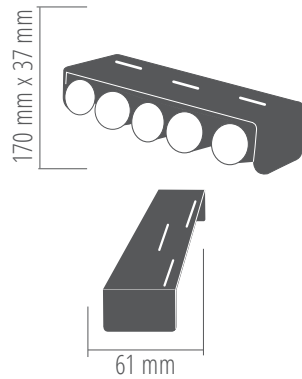

222-511

129,95 €  
UVP pro Stück

Beleuchtungsbeispiel



## HANDPROTEKTOREN

MIT LED-TAGFAHRLICHT

Beleuchtungsbeispiel



399,95 €  
UVP pro Paar

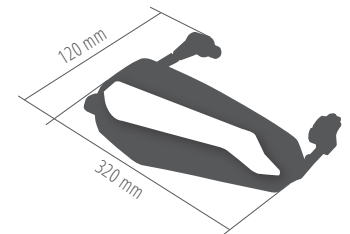

320-100

## CAN-BUS WIDERSTAND CBW1

HIGHSIDER CAN-BUS Widerstand CBW1 mit DIP-Schalter. Unser neu entwickelter HIGHSIDER CAN-BUS Widerstand CBW1 passt für die meisten Fahrzeuge, die über ein CAN-BUS System verfügen. Der Widerstand CBW1 stellt die benötigte elektrische Last für ihr Fahrzeug zur Verfügung, die bei korrekter Einstellung der Dip Schalter dazu führt, dass es bei Zubehörblinkern zu keiner Fehlermeldung im Cockpit führt. Außerdem ist eine Ausfallsicherheit gegeben. Das heißt: Bei einem Ausfall der Zubehörblinkler durch einen elektronischen Defekt wird sofort eine Fehlermeldung im Cockpit angezeigt. Es können bis zu 2 Kanäle bedient werden, wie zum Beispiel Blinker hinten links und Blinker hinten rechts.

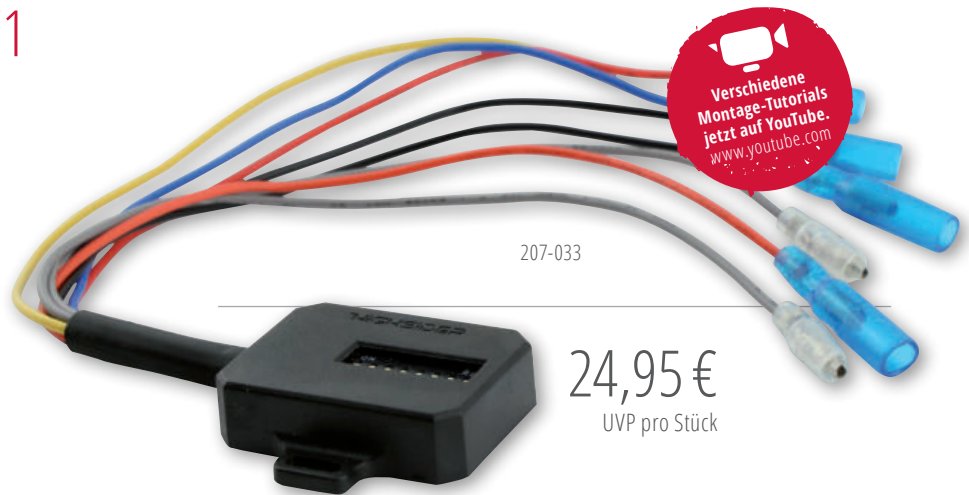

207-033

24,95 €  
UVP pro Stück



## PLUS - MINUS KONVERTER CB3

Der Plus-Minus Konverter CB3 wandelt ein Massesignal in ein Plussignal um und ist dafür vorgesehen, dass die massegesteuerte Beleuchtungseinrichtungen auf Plus gewandelt werden.

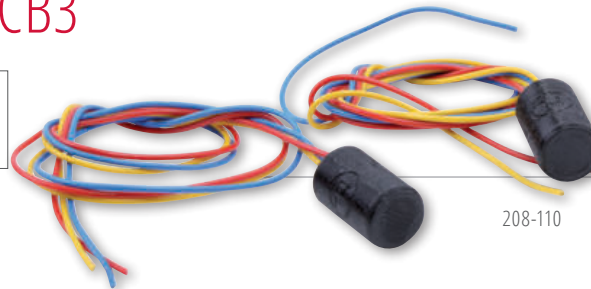

208-110

24,95 €  
UVP pro Paar



## E-BOX TYP 1

FÜR DRL SCHALTUNG PER LICHTSENSOR

HIGHSIDER E-BOX TYP 1, für DRL Schaltung per Lichtsensor, 20 Polig, Zur automatischen Schaltung zwischen Tagfahrlicht und Abblendlicht. Die HIGHSIDER PW E-BOX TYP 1 erkennt, wenn es dunkel oder hell wird und schaltet das Abblendlicht an bzw. aus.

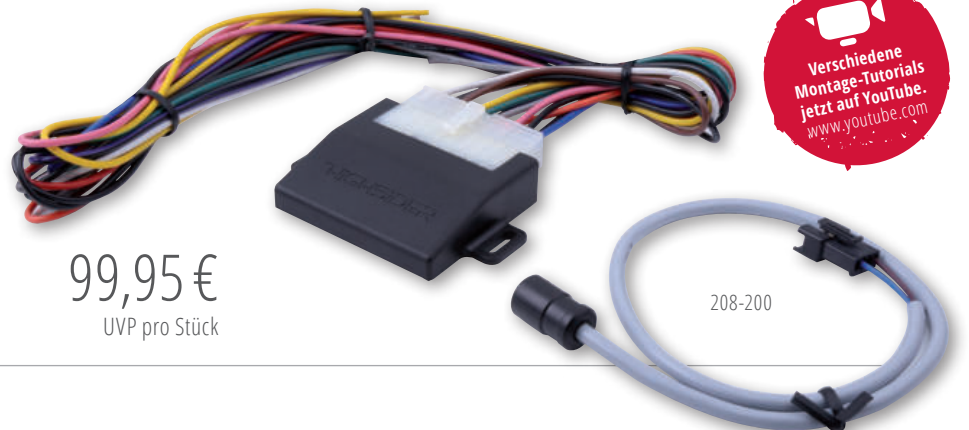

99,95 €  
UVP pro Stück

208-200



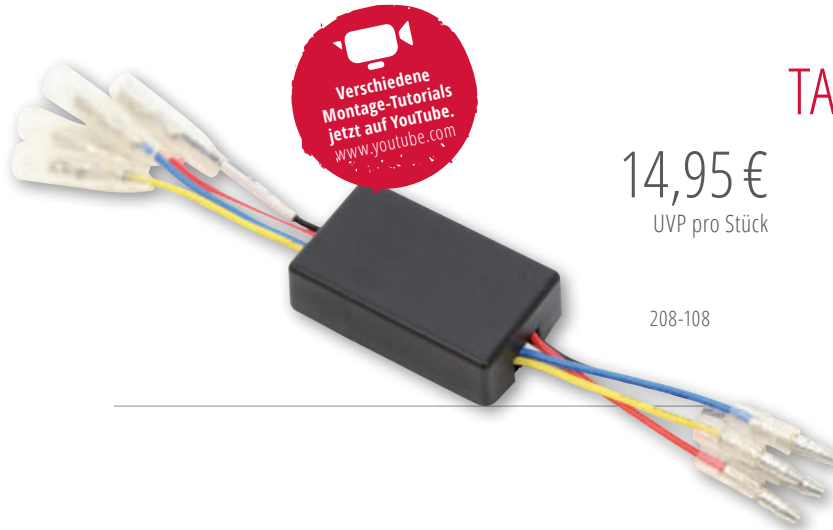

14,95 €  
UVP pro Stück

208-108

## TAGFAHRLICHT CONTROL BOX CB1

FÜR FAHRZEUGE OHNE LICHTSCHALTER

Durch Verbauen der DRL CONTROL- BOX CB1 ist die korrekte Schaltung zwischen Tagfahrlicht und der Beleuchtung vorne am Fahrzeug gegeben. Laut Vorschrift muss das Tagfahrlicht so angeschlossen werden, dass es beim Anschalten des Hauptscheinwerfers ausgeht. Da bei Fahrzeugen ohne Lichtschalter der Hauptscheinwerfer immer an ist, wäre die Funktion des Tagfahrlicht nicht korrekt nutzbar. Die BOX ist für LED und herkömmliche Scheinwerfer geeignet und wird zwischen dem Hauptscheinwerfer mit integrierten oder separaten Tagfahrlicht und der Fahrzeugelektrik verbaut. Die Funktion des Parklichtes, das man beim Abstellen des Fahrzeugs über das Zündschloss schaltet, bleibt voll funktionsfähig.

**Hinweis:** Zum Umschalten zwischen normaler Beleuchtung und TFL wird noch ein Schalter benötigt.

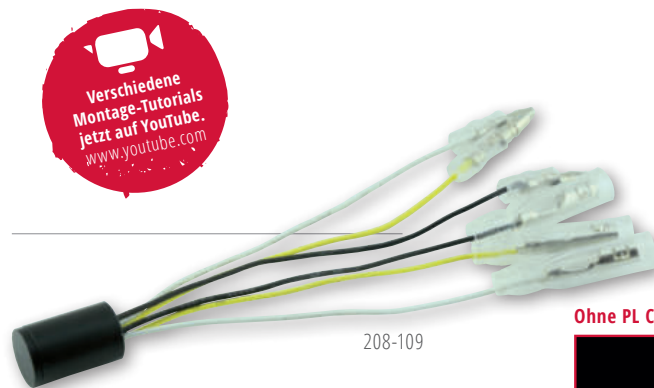

19,95 €  
UVP pro Stück

208-109

## PL CONTROL- BOX CB2

Die HIGHSIDER™ CB2 PL CONTROL- BOX mit wenigen Arbeitsschritten zwischen die 2-in-1 Blinker/Positionsleuchten stecken und um ein klasse Sicherheitsfeature erweitern. Die Box schaltet das Positionslicht während des Blinkvorganges ab und geht erst nach dem Blinkvorgang wieder an, somit wird das Blinksignal im Straßenverkehr noch besser wahrgenommen.

**Hinweis:**  
Nicht geeignet für Scheinwerfer mit Positionslicht.

Ohne PL Control-Box CB2

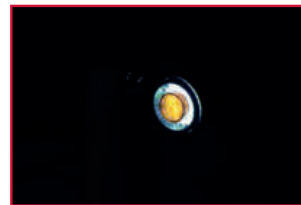

Mit PL Control-Box CB2

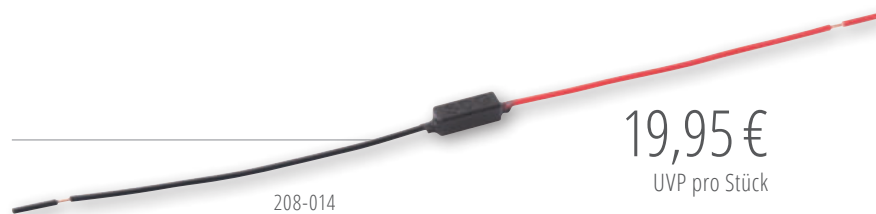
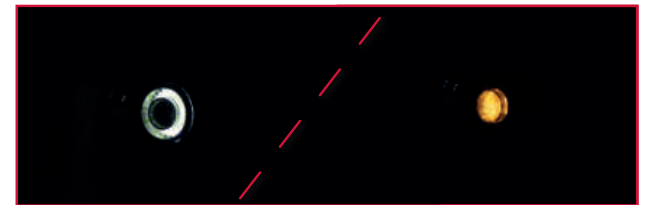

19,95 €  
UVP pro Stück

208-014

## DIGITALES BLINKRELAIS

Extrem kleiner, lastunabhängiger digitaler Blinkgeber, der sich ideal für LED-Blinker-Umbauten oder für herkömmliche 10 Watt- oder 21-Watt Blinker-Birnen eignet. Das Relais liefert eine absolut konstante Blinkfrequenz und passt in fast alle Lenkrohre oder Rahmen.

Maße: Länge: 15 mm, Breite: 5 mm, Höhe: 6 mm



# ALU LAMPENHALTER SET EXTEND

Hochwertig verarbeiteter Lampenhalter, der durch mehrere Einstellmöglichkeiten das Ausrichten des Scheinwerfers an Ihrem Chopper, Cruiser oder Nakedbike vereinfacht. Das schwarze Lampenhalter-Set aus Aluminium enthält 4 Gabelrohrschellen sowie je 2 Halter und Reduzierstreifen. Das EXTEND Lampenhaltersset ist in der Länge verstellbar, so kann der Abstand für den Scheinwerfer variabel von ca. 35 mm bis 90 mm verstellt werden. Die Halter sind so an den Schellen befestigt, dass sie auf die Scheinwerferbreite eingestellt werden können. Erhältlich als Set für die Durchmesser: 35-37 mm, 38-41 mm, 42-43 mm & 47-49-50-52-54 mm



Unsere Sets werden mit passenden Schellen geliefert



129,95 €  
UVP pro Set

**Bestell dir das passende Set.**

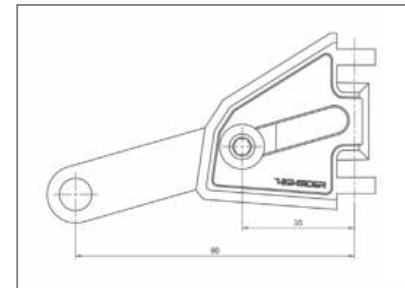

**Du hast die Wahl!**



220-8104X

**Der Abstand für den Scheinwerfer kann variabel von ca. 35 mm bis 90 mm verstellt werden**

## CNC ALU LAMPENHALTER

HIGHSIDER bietet diverse hochwertige und edle Lampenhalter an.  
Alle Lampenhalter in diversen Standrohr-Durchmessern gibt es auf  
[www.highsider-germany.de](http://www.highsider-germany.de)



109,95 €  
UVP pro Set

Kurz

220-816XXX



Mittel

220-618

109,95 €  
UVP pro Set



Lang

220-818402

109,95 €  
UVP pro Set



Alle Lampenhalter gibt es auch in Chrom.

## CNC ALU LAMPENHALTER BOTTOM

TYP 1 (für Standrohrbreite von 180 - 220 mm) und TYP 2 (für Standrohrbreite von 205 - 245 mm).  
Zur Montage werden unsere Schellen 207-402 bis 207-419 benötigt (UVP 39,95 / Paar).

44,95 €  
UVP pro Stück



Typ 1: Art.Nr. 220-220  
Typ 2: Art.Nr. 220-222



Typ 1: Art.Nr. 220-221  
Typ 2: Art.Nr. 220-223

## CNC HALTER RS 1

Die Montage der Zusatzscheinwerfer z.B. Satellite ist dank dem schwarz-eloxierten Highsider CNC Halter RS1 kein Problem mehr. Die Halter lassen sich mit unseren CNC Standrohrschellen 207-402 bis 207-419 bequem und schnell an nahezu allen Standrohren montieren. Die RS1 Halter sind universal einsetzbar.

29,95 €  
UVP pro Paar



## CNC HALTER RS 2

Dieser Halter ist ein echter Allrounder. Er kann zur Aufnahme von Instrumenten-, Navi- oder Handy-Halterungen genutzt werden. Mit einer Montage am Sturzbügel lassen sich Zusatzscheinwerfer befestigen. Insgesamt sorgen fünf Bohrungen mit einem M6-Innengewinde für eine größtmögliche Flexibilität bei der Verwendung. Durch die beiliegenden Einlegesohlen kann der RS 2 an Rohren mit 20/22/27/28 mm Durchmesser verbaut werden.

24,95 €  
UVP pro Stück



220-101



## CNC GEFRÄSTE LENKERSCHELLE

Diese elegante Schelle aus Aluminium wird am Lenker montiert und dient der Aufnahme von Instrumenten, Navi- / Handy-Halterungen oder anderem Zubehör. Die Schelle hat an der Frontseite ein M6 Gewinde zur Befestigung von Zubehörteilen.

1/8 ZOLL  
1 ZOLL



207-362  
207-360

14,95 €  
UVP pro Stück



207-363  
207-361





— BLINKER —

## LED SEQUENZ-BLINKER STS 1

Stylish, stylicher, STS! Unser STS 1 bietet ein rassiges, dynamisches Design. Zusammen mit der Lauflicht Funktion ist dieser Blinker ein echter "Hingucker" an modernen Bikes!



203-220

203-221

129,95 €  
UVP pro Paar

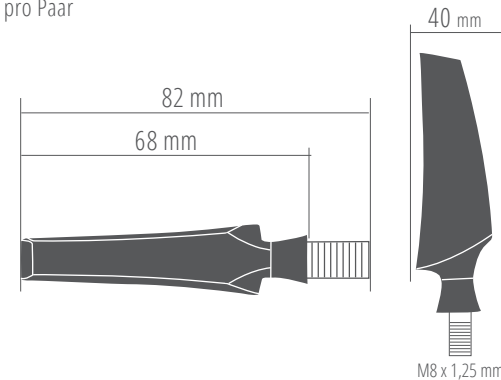

## LED SEQUENZ-BLINKER STRIPE RUN

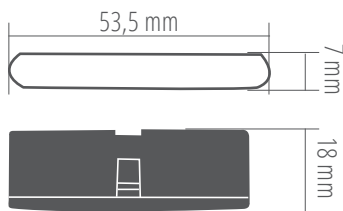

69,95 €  
UVP pro Paar

Beleuchtungsbeispiel

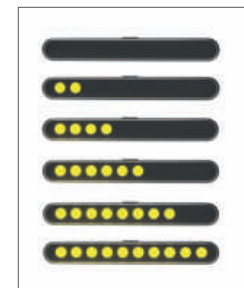
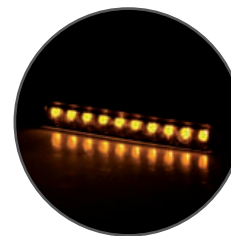

204-101

Dieser Artikel ist Bestandteil der CLASSIC Serie.

204-176



Erhältlich als:

-  Blinker (Art.Nr.: 204-176 / 204-177)
-  Rücklicht-Blinker-Einheit (Art.Nr.: 254-176 / 254-177)
-  Blinker-Positionslicht-Einheit (Art.Nr.: 204-178 / 204-179)

ab **119,95 €**  
UVP pro Paar

## APOLLO CLASSIC

-  LED
-  Paar
-  Alu
-  COB
- 
- 

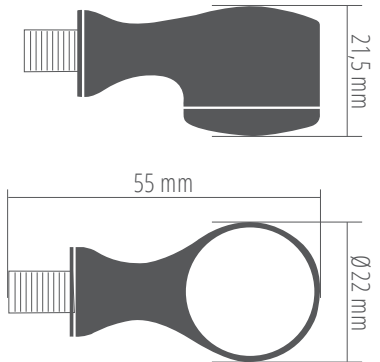

204-177



Dieser Artikel ist Bestandteil der CONERO Serie.

Erhältlich als:

-  Blinker (Art.Nr.: 204-033)
-  Rücklicht-Blinker-Einheit (Art.Nr.: 254-033)



204-033

Beleuchtungsbeispiel

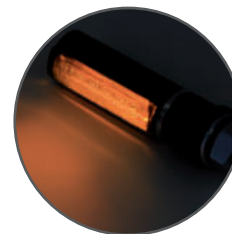

ab **99,95 €**  
UVP pro Paar

-  LED
-  Paar
-  Alu
-  COB
- 
- 

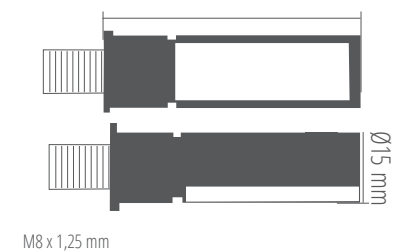



## PROTON – winzig & leistungsstark

Mit einem PROTON kann die Komponente Blinker am Motorrad optisch quasi verschwinden. Dieser Blinker fällt nur auf, wenn er wirklich muss, bei Abbiege- oder Überholabsichten. Der Trend hin zu immer kleineren Beleuchtungselementen ermöglicht es dem Biker seinem Motorrad eine coole und cleane Optik zu verpassen. Schluss mit überdimensionierten Leuchtfackel-Anlagen aus Zeiten unserer Vorfahren. Die nächstkleinere Stufe ist erreicht und eröffnet völlig neue Gestaltungsoptionen am Motorrad.

Unseren PROTON bieten wir in 5 verschiedenen Beleuchtungseinheiten an:



Blinker



Positionslicht



Blinker-Positionslicht



Rücklicht-Blinker



Rücklicht

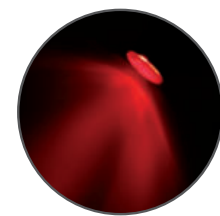
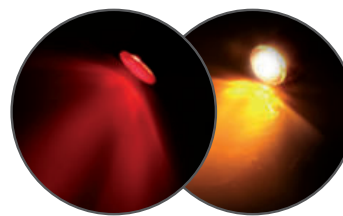
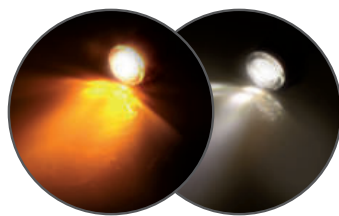
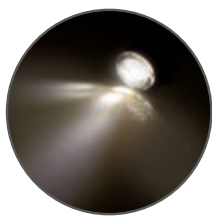
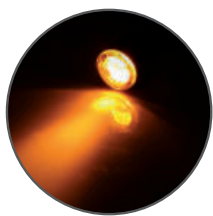

## PROTON ONE



Erhältlich als:

-  Blinker (Art.Nr.: 204-535)
-  Positionslicht (Art.Nr.: 204-536)
-  Rücklicht-Blinker-Einheit (Art.Nr.: 254-535)
-  Blinker-Positionslicht-Einheit (Art.Nr.: 204-537)

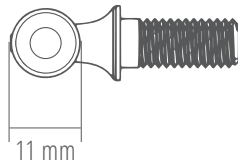
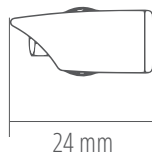

ab 79,95 €  
UVP pro Paar

## PROTON TWO



Erhältlich als:

-  Blinker (Art.Nr.: 204-540)
-  Positionslicht (Art.Nr.: 204-541)
-  Rücklicht-Blinker-Einheit (Art.Nr.: 254-540)
-  Blinker-Positionslicht-Einheit (Art.Nr.: 204-542)

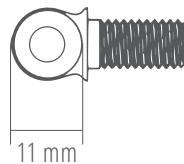

ab 79,95 €  
UVP pro Paar

## PROTON THREE



Erhältlich als:

-  Blinker, Paar (Art.Nr.: 204-545)
-  Positionslicht, 44,95€ / Stück (Art.Nr.: 204-546)
-  Rücklicht-Blinker-Einheit, Paar (Art.Nr.: 254-545)
-  Blinker-Positionslicht-Einheit, Paar (Art.Nr.: 204-547)
-  Rücklicht, 49,95€ / Stück (Art.Nr.: 255-545)

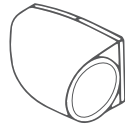
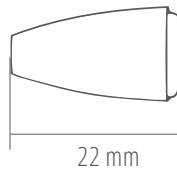
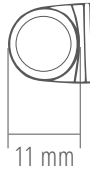

Der PROTON THREE ist super für Naked, Chopper und natürlich auch Sportler geeignet. Leichte Montage durch Aufkleben.

ab **89,95 €**  
UVP pro Paar

## PROTON MODUL



Erhältlich als:

-  Blinker, Paar (Art.Nr.: 204-530)
-  Positionslicht, 34,95€ / Stück (Art.Nr.: 204-531)
-  Rücklicht-Blinker-Einheit, Paar (Art.Nr.: 254-530)
-  Blinker-Positionslicht-Einheit, Paar (Art.Nr.: 204-532)
-  Rücklicht, 34,95€ / Stück (Art.Nr.: 255-530)

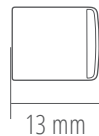

ab **69,95 €**  
UVP pro Paar

Leichte Montage durch Einlaminiern oder Einkleben.





D



highsider-germany.de





# BRONX

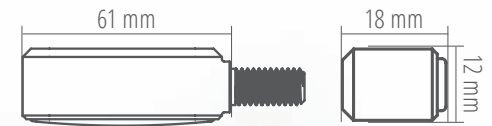

99,95 €  
UVP pro Paar

Beleuchtungsbeispiel





# ENTERPRISE-EP1

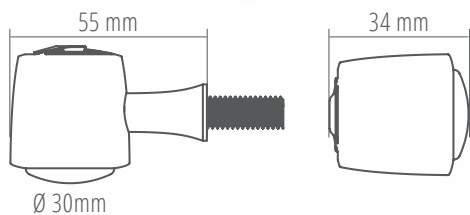

Dieser Artikel ist Bestandteil der EP1 Serie.

Erhältlich als:

-  Blinker (Art.Nr.: 204-1900 bis 204-1904)
-  Rücklicht-Blinker-Einheit (Art.Nr.: 254-1900 bis 254-1904)

ab 129,95 €  
UVP pro Paar

204-1902

204-1904

204-1900

204-1901

Beleuchtungsbeispiel:  
Rücklicht-Bremslicht-Blinker-Kombi



# PRINT YOUR OWN LIGHT

Das PRINTLIGHT ist die zukunftsweisende Art, individuelle Wünsche zu erfüllen.

Wir stellen euch das tolle geschützte Design eines Blinkergehäuses zur Verfügung, bei dem du selbst die Farbe und das Material bestimmen kannst! Die geprüften LED Einsätze bekommst du als Paar dazu, diese musst du nur noch in das von dir gedruckte Gehäuse einkleben.

Beim Kauf des Bausatzes erhältst du einen QR-Code. Mit dem Link erhältst du dann die Druckdaten, die du dir herunterladen kannst. Mit diesen Druckdaten kannst du dann direkt selbst oder in einem 3D Drucker Shop deine Wunschblinker ausdrucken lassen.



202-101

PRINTLIGHT-T2



PRINTLIGHT-T3



202-102

ab 32,95 €  
UVP pro Paar

Beispiel für Printlight-T1



PRINTLIGHT-T1



202-100



Die Gehäuse sind mögliche Farbbeispiele.  
Im Lieferumfang enthalten sind die LED Einsätze, sowie der QR-Code für die Druckdaten



ab 119,95 €  
UVP pro Paar

Beleuchtungsbeispiel



## APOLLO BULLET

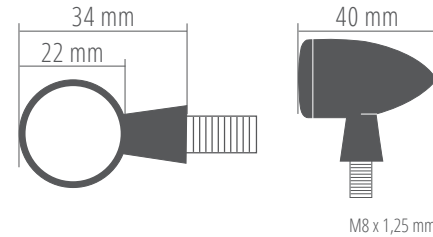

Erhältlich als:

-  Blinker (Art.Nr.: 204-171)
-  Rücklicht-Blinker-Einheit (Art.Nr.: 254-171)
-  Blinker-Positionslicht-Einheit (Art.Nr.: 204-173)

204-171

## APOLLO

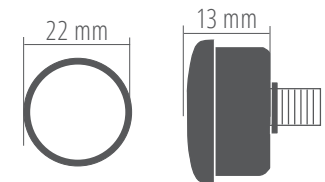

M6 x 1.0 mm x L. 12 mm

zum Einbau geeignet

Beleuchtungsbeispiel



ab 79,95 €  
UVP pro Paar

Erhältlich als:

-  Blinker (Art.Nr.: 204-170)
-  Rücklicht-Blinker-Einheit (Art.Nr.: 254-170)
-  Blinker-Positionslicht-Einheit (Art.Nr.: 204-172)

204-170



# MONO BULLET LONG



99,95 €  
UVP pro Paar

203-217



203-218

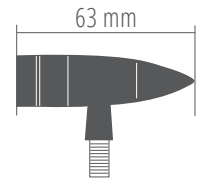
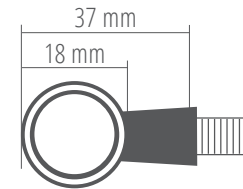

M8 x 1.25 mm, L: 19 mm

Erhältlich als:

-  Blinker (Art.Nr.: 203-217 / 203-218)
-  Rücklicht 49,95€ / Stk (Art.Nr.: 255-017 / 255-018)



203-215

79,95 €  
UVP pro Paar



203-216

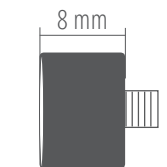
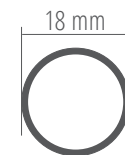

M10 x 1.5 mm, L: 13 mm

## COLORADO

ab 59,95 €  
UVP pro Paar

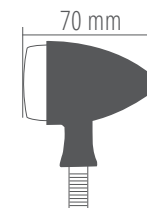
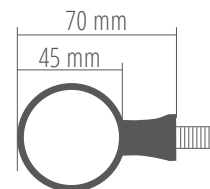

M10 x 1,5 mm



203-201



203-200

Erhältlich als:

-  Blinker  
(Art.Nr.: 203-200 / 203-201)
-  Rücklicht-Blinker-Einheit  
(Art.Nr.: 254-200 / 254-201)

## COLORADO-MODUL



ab 34,95 €  
UVP pro Paar

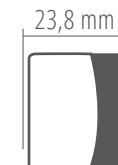
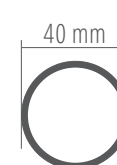

zum Einbau geeignet





203-205

Erhältlich als:

-  Blinker  
(Art.Nr.: 203-205)
-  Rücklicht-Blinker-Einheit  
(Art.Nr.: 254-205)

# BLAZE

Erhältlich als:

-  Blinker  
(Art.Nr.: 204-300 / 204-301 / 204-302)
-  Rücklicht-Blinker-Einheit  
(Art.Nr.: 254-300 / 254-301 / 254-302)
-  Blinker-Positionslicht-Einheit  
(Art.Nr.: 204-304)



ab **74,95 €**  
UVP pro Paar

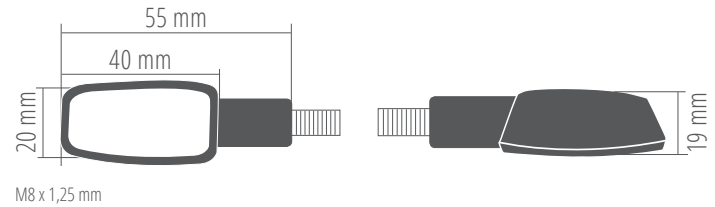

204-300



204-301

204-302

# LED MICRO BULLET



**44,95 €**  
UVP pro Paar

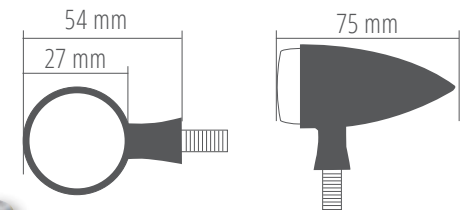

203-119



203-118

Erhältlich als:

-  Blinker  
(Art.Nr.: 203-118 / 203-119)
-  Rücklicht 29,95€ / Stk  
(Art.Nr.: 255-119 / 255-117)





79,95 €  
UVP pro Paar

204-116



## TYP 1

mit CNC Spiegelbefestigung

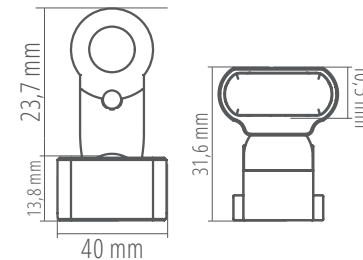

204-114

79,95 €  
UVP pro Paar

## TYP 2

mit CNC Spiegelbefestigung

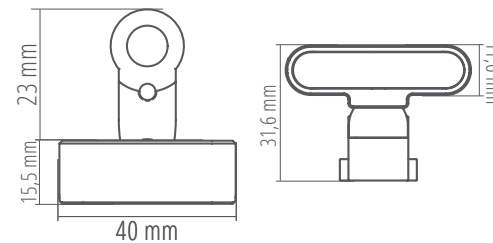

Erhältlich als:

-  Blinker  
(Art.Nr.: 204-342 / 204-343)
-  Rücklicht-Blinker-Einheit  
(Art.Nr.: 254-342 / 254-343)
-  Blinker-Positionslicht-Einheit  
(Art.Nr.: 204-344 / 204-345)
-  Rücklicht 89,95€ / Stk  
(Art.Nr.: 255-342 / 255-343)

ab **129,95 €**  
UVP pro Paar



204-342

Mit neuester COB-Technik



204-343

## ROCKET CLASSIC

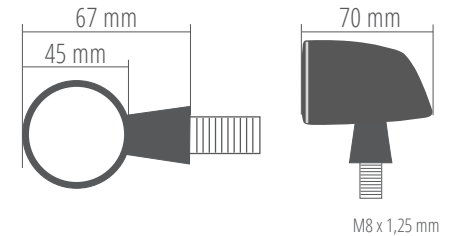

Erhältlich als:

-  Blinker  
(Art.Nr.: 204-346 / 204-347)
-  Rücklicht-Blinker-Einheit  
(Art.Nr.: 254-346 / 254-347)
-  Blinker-Positionslicht-Einheit  
(Art.Nr.: 204-348 / 204-349)

ab **129,95 €**  
UVP pro Paar



Mit neuester COB-Technik



## ROCKET BULLET

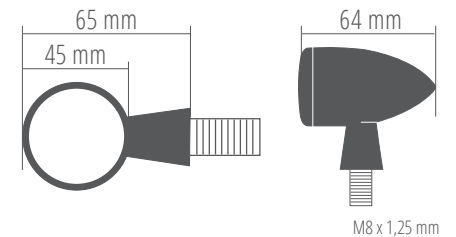

# SONIC-X1



ab 49,95 €  
UVP pro Paar

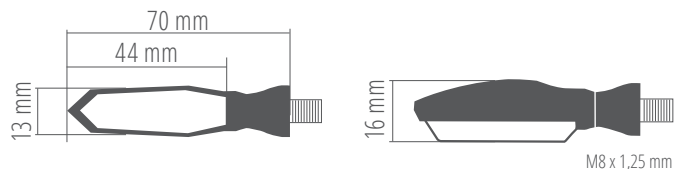

Erhältlich als:

-  Blinker (Art.Nr.: 204-270)
-  Rücklicht-Blinker-Einheit (Art.Nr.: 254-270)



204-270

# SONIC-X2



49,95 €  
UVP pro Paar

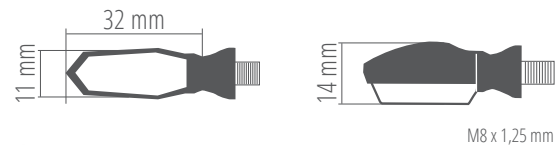

204-272



204-273



## PEN HEAD



67,95 €  
UVP pro Paar

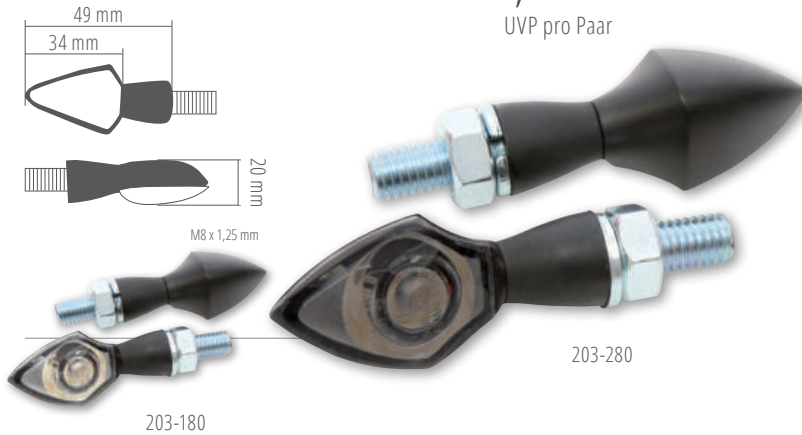

## CORTONA



59,95 €  
UVP pro Paar



## FALCON



~~89,95 €~~  
69,95 €  
UVP pro Paar

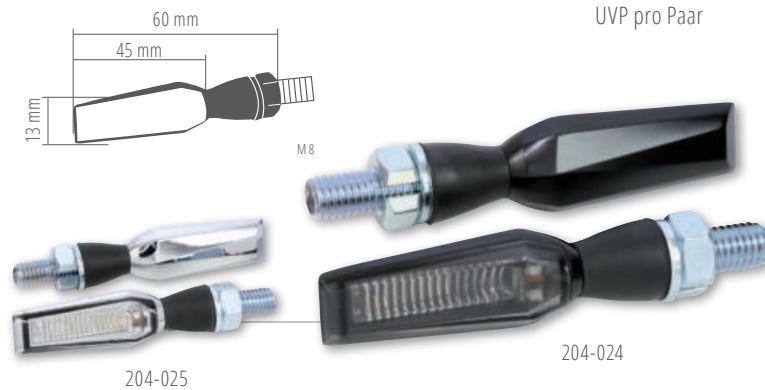

## STREAM



69,95 €  
UVP pro Paar

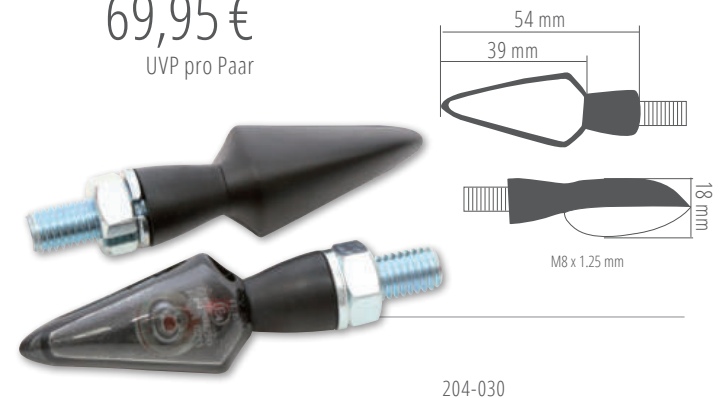

# STRIPE

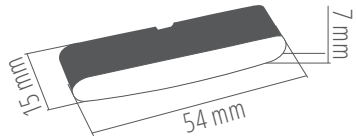

204-100



204-099

36,95 €  
UVP pro Paar

Erhältlich als:

-  Blinker (Art.Nr.: 204-099 / 204-100)
-  Rücklicht 22,95€ / Stk (Art.Nr.: 255-023 / 255-024 / 255-025)



# STRIPE

mit Alu-Gehäuse

Dieser LED-Blinker ist auch mit Halter erhältlich.  
(Art.Nr. 204-105 & 204-106)

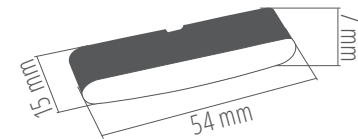

204-108

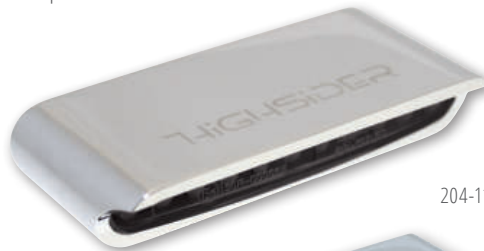

204-111



204-110



204-109

64,95 €  
UVP pro Set

Erhältlich als:

-  Blinker (Art.Nr.: 204-109 / 204-111)
-  Rücklicht 39,95€ / Stk (Art.Nr.: 255-028 / -029 / -32 / -033 / -034 / -035)

## FLIGHT

Mit dem beiliegenden Adapter kann der FLIGHT Blinker mit oder ohne Spiegel, schnell und einfach an das Lenkerende montiert werden.



Dieser Artikel ist Bestandteil der FLIGHT Serie.



Montage leicht gemacht!  
Kein Verschieben der Griffe und Lenkerarmaturen mehr nötig!



203-001

119,95 €  
UVP pro Paar

## FLIGHT

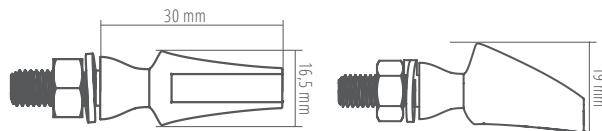

203-002

79,95 €  
UVP pro Paar



## ABDECKHÜLSEN

HIGHSIDER™ Abdeckhülsen aus Kunststoff für Blinker mit M8 Gewinde. Nach der Montage der neuen Blinker kann mit Hilfe der Abdeckhülsen aus Kunststoff das M8-Gewinde und die Befestigungsmutter abgedeckt werden. Für ein schöneres Finish und Schutz vor Korrosion.

3,45 €

UVP pro 4 Stück

207-130



## CNC BLINKERHALTER

Schwarz eloxierter Halter aus gefrästem Aluminium zur Montage von Blinkern an den CNC Alu Standrohrschellen der Art-Nr. 207-40X (nicht im Lieferumfang enthalten). Der CNC Blinkerhalter wird an den CNC Alu Standrohrschellen verschraubt. Universal einsetzbar.



9,95 €

UVP pro Paar

Ø 8mm

Ø 5mm

207-122



Anbaubeispiel



## BLINKERVERLÄNGERUNG

Blinkerverlängerung, 27 mm. Verlängerung für Blinker mit M8-Gewindebolzen, schwarz.



207-013



19,95 €

UVP pro Paar

## CABLE FIX

HIGHSIDER™ CABLE FIX. Zum Fixieren von Kabeln an den HIGHSIDER™ CNC Alu Standrohrschellen 207-40x. Auch universal einsetzbar.



207-124



9,95 €

UVP pro 10 Stück

Anbaubeispiel



## ALU BLINKER MONTAGEPLATTE

FÜR BMW R NINE T.

Aus Aluminium gefertigt und schwarz lackiert. Die passgenaue Form ermöglicht den Anbau diverser Zubehörblinker anstelle der Originalblinker. Für vorne oder hinten.



12,95 €

UVP pro Set

207-501



207-500

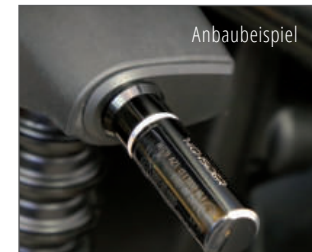

## CNC ABDECKKAPPEN

CNC Abdeckkappen für M10 Spiegelgewinde, schwarz

160-314



6,99 €

UVP pro Paar

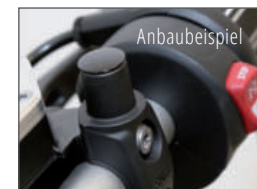

— RÜCKLICHTER —



# BELEUCHTUNG

Beleuchtungsbeispiel



89,95 €  
UVP pro Stück

## ROCKET CLASSIC



255-343



255-342

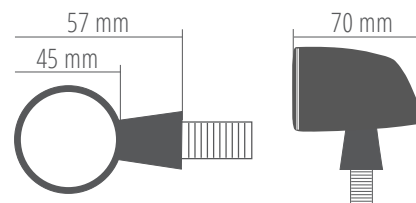

Beleuchtungsbeispiel

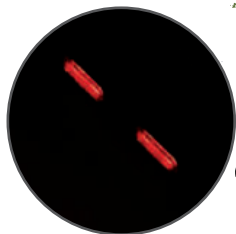

Dieser Artikel  
ist Bestandteil  
der FLIGHT Serie.

99,95 €  
UVP pro Stück

## FLIGHT



255-111



255-112

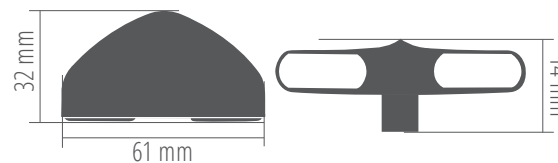



# ORGANIC

Beleuchtungsbeispiel

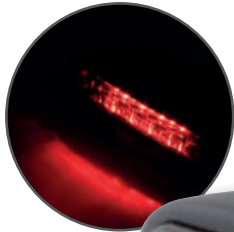

39,95 €  
UVP pro Stück

255-181

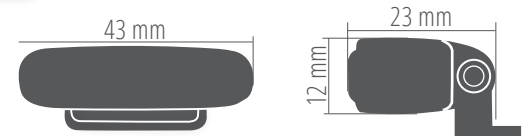

Dieser Artikel  
ist Bestandteil  
der CONERO Serie.

Beleuchtungsbeispiel



39,95 €  
UVP pro Stück

255-164



# CONERO T1

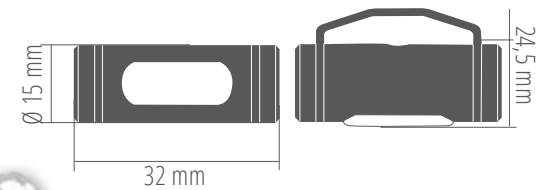

255-163

Beleuchtungsbeispiel



## CONERO T2



39,95 €  
UVP pro Stück

Dieser Artikel  
ist Bestandteil  
der CONERO Serie.



255-167



255-168

## LITTLE NUMBER 1

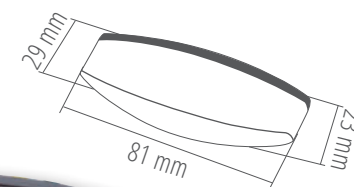

29,95 €  
UVP pro Stück



255-140



255-141



255-142

# METALLGEHÄUSE

für Little Number 1 (Art.Nr. 255-140, 255-141, 255-142)  
mit verstellbarem Halter



255-140H

24,95 €  
UVP pro Stück

Stück Alu

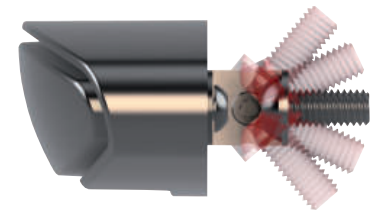

Verstellbarer Halter für eine einfache Montage

# INTERSTATE

34,95 €  
UVP pro Stück

LED Stück Metall D E



255-905

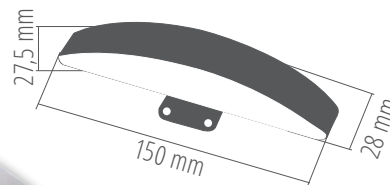

255-906

# MALIBU

16,95 €  
UVP pro Stück

LED Stück Kunststoff D E

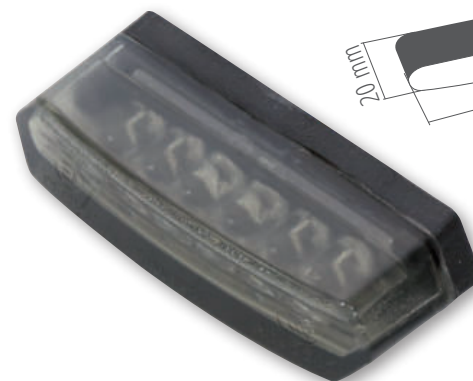

255-011

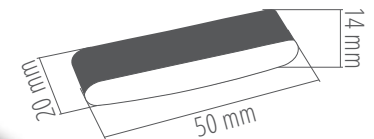





255-095

32,95 €  
UVP pro Stück



255-096

## GOTHIC

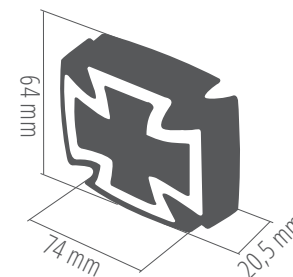

## STRING

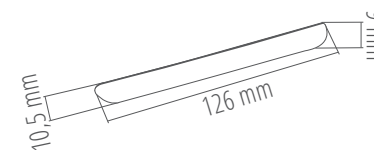

29,95 €  
UVP pro Stück

255-200



255-201



— SPIEGEL —

PASS

HIGHSIDER  
HIGHSIDER

Dieser Artikel ist Bestandteil der WAVE Serie.

WAVE

Paar Alu 

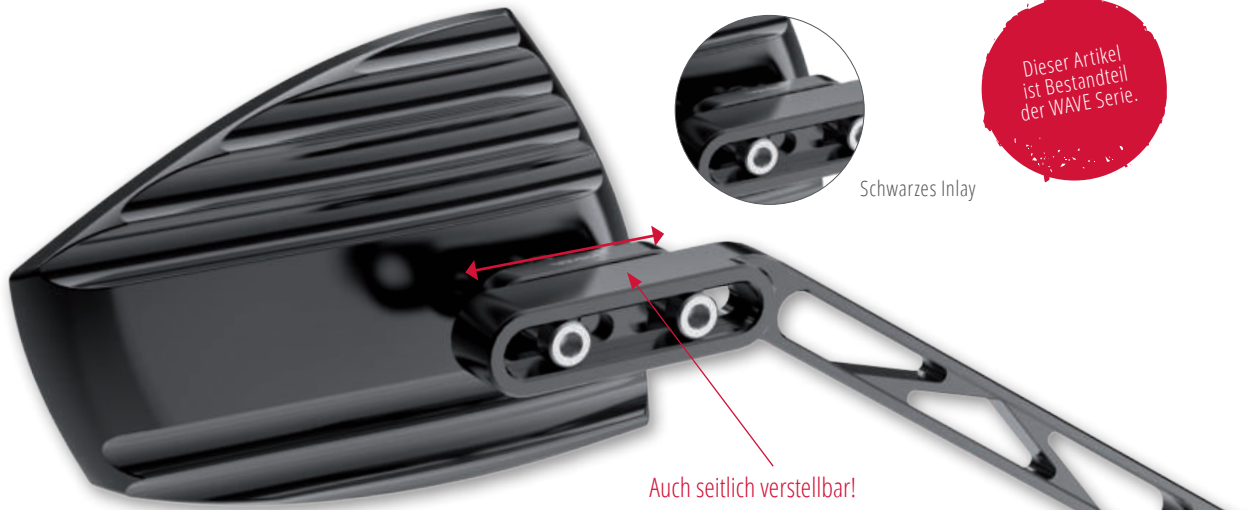
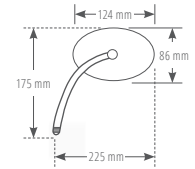

Schwarzes Inlay

Auch seitlich verstellbar!

301-4900

169,95 €  
UVP pro Paar



Rotes Inlay

301-4902



**CHOOSE YOUR COLOUR!**



Goldenes Inlay

301-4904



Silbernes Inlay

301-4901





301-4922

301-4920

301-4921



301-4924

Dieser Artikel ist Bestandteil der WAVE Serie.

WAVE

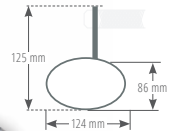

169,95 €  
UVP pro Paar

WAVE

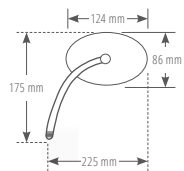

169,95 €  
UVP pro Paar

Dieser Artikel ist Bestandteil der WAVE Serie.



301-4910







89,95 €  
UVP pro Paar

301-450

## STEALTH-X1

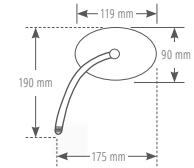

Vollflächiges Licht

139,95 €  
UVP pro Paar

301-452

## STEALTH-X3 mit Positionslicht

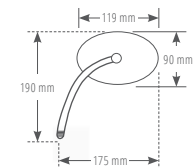

## STEALTH-X5

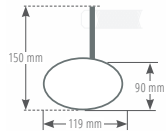

Flexible Montage  
durch  
verstellbaren Stiel.

49,95 €  
UVP pro Stück

301-454

## STEALTH-X6

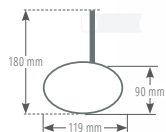

49,95 €  
UVP pro Stück

301-455

## STEALTH-X7

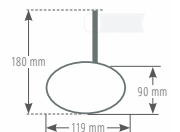

89,95 €  
UVP pro Stück

301-456

# ENTERPRISE-EP1

89,95 €  
UVP pro Stück

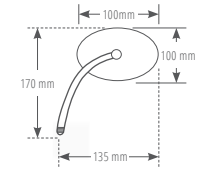

301-5220



301-5221



301-5222



301-5224



# ENTERPRISE-EP1

Flexible Montage  
durch  
verstellbaren Stiel.

301-5230



Stück CNC Alu L+R 

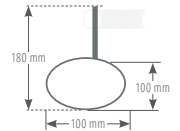

89,95 €  
UVP pro Stück

Dieser Artikel  
ist Bestandteil  
der EP1 Serie.

301-5234



301-5232



301-5231





**HiGHSIDER™**

POWERED BY PAASCHBURG & WUNDERLICH





### ENTERPRISE EP-1

Art.Nr. 301-5234



### PECOS TYP 6

Art.Nr. 223-219



### CNC KENNZEICHEN HALTEPLATTE

Art.Nr. 282-010



### ENTERPRISE EP-1

Art.Nr. 204-1904

Art.Nr. 254-1904



### ENTERPRISE EP-1

Art.Nr. 161-0904

# DUCATI SCRAMBLER



### CONERO

Art.Nr.315-056

# CNC VICTORY-X LENKERENDENSPIEGEL

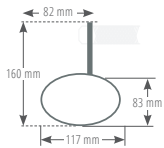

54,95 €  
UVP pro Stück

301-181

# LENKERENDENSPIEGEL mit LED-Blinker

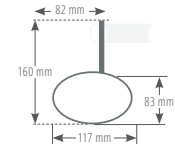

Verschiedene  
Montage-Tutorials  
jetzt auf YouTube.  
[www.youtube.com](http://www.youtube.com)

79,95 €  
UVP pro Stück

301-182



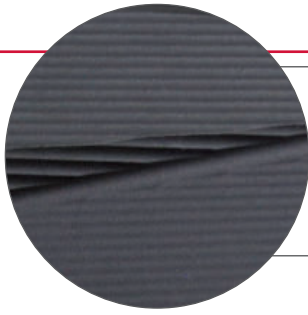

Alle 3 Spiegelvarianten weisen eine edle und hochwertige Oberfläche mit feinen CNC gefrästen Linien auf.



301-180

49,95 €  
UVP pro Stück

## LENKERSPIEGEL

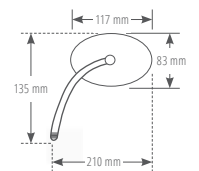



301-028

74,95 €  
UVP pro Stück



**VICTORY**  
mit LED-Blinker

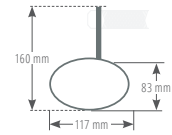

301-023

74,95 €  
UVP pro Paar

**VICTORY**



301-022

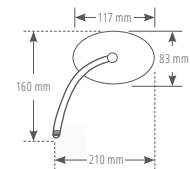

49,95 €  
UVP pro Stück



301-025



301-024

## VICTORY

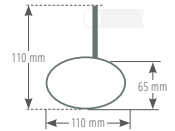

## VICTORY EVO

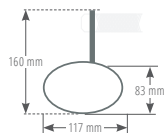

64,95 €  
UVP pro Stück



301-026



44,95 €  
UVP pro Stück



301-021

## VICTORY

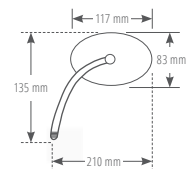

301-020

# VICTORY-BLAST

Stück Alu Matt L+R 

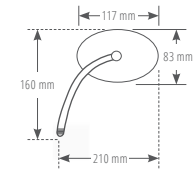

44,95 €  
UVP pro Stück

301-124

Unser Bestseller jetzt mit einer seidenmatten Oberfläche!

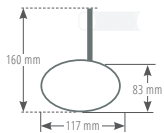

64,95 €  
UVP pro Stück



301-126

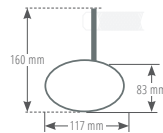

49,95 €  
UVP pro Stück



301-125

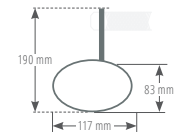

LED

74,95 €  
UVP pro Stück



301-127





# CONERO BLACK EDITION

Stück Alu Matt L+R 

Unser CONERO jetzt mit matt schwarz eloxierter Oberfläche.

69,95 €  
UVP pro Stück



301-293

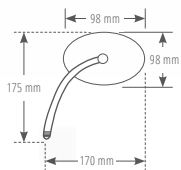

59,95 €  
UVP pro Stück

Lang



301-295

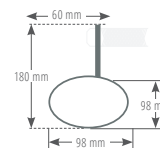

59,95 €  
UVP pro Stück

Kurz



301-294

Flexible Montage durch verstellbaren Stiel.

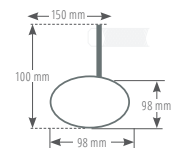

## CONERO

Stück Alu L+R 

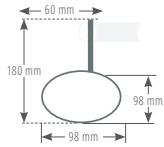

69,95 €  
UVP pro Stück



301-014



## CONERO

mit LED-Blinker

LED Stück Alu L+R 

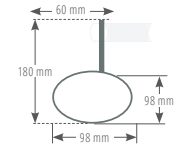

89,95 €  
UVP pro Stück



301-038

## CONERO

Stück Alu L+R 

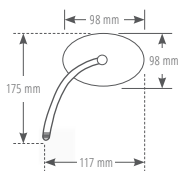

69,95 €  
UVP pro Stück

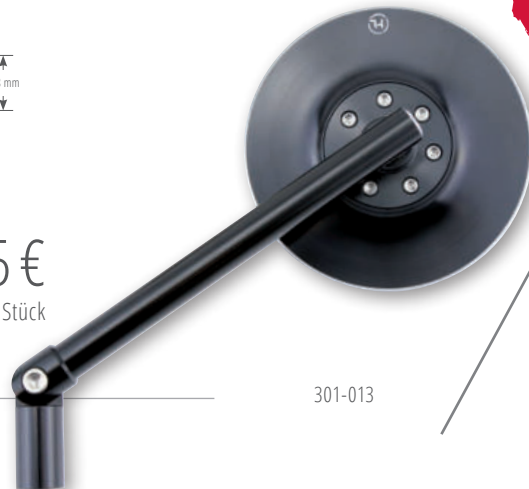

301-013



## CONERO 2

Stück Alu L+R 

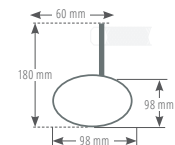

59,95 €  
UVP pro Stück



301-037



44,95 €  
UVP pro Stück



## FERRARA 2

Stück Alu L+R

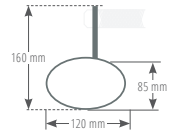

## FERRARA 2 EVO

Stück Alu L+R

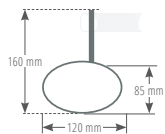

64,95 €  
UVP pro Stück

301-784



39,95 €  
UVP pro Stück

## FERRARA 2

Stück Alu L+R

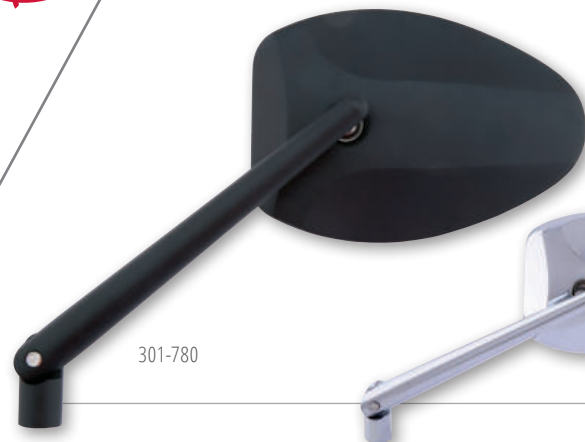
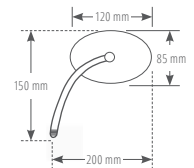

49,95 €  
UVP pro Stück



301-018



301-017

## MONTANA

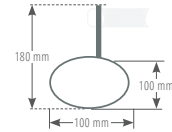

## MONTANA EVO

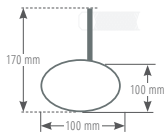

301-019

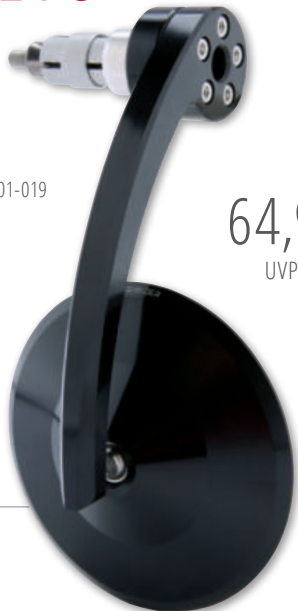

64,95 €  
UVP pro Stück

## MONTANA

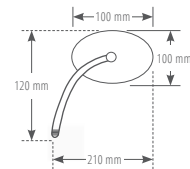

301-016

44,95 €  
UVP pro Stück



301-015







Flexible Montage durch verstellbaren Stiel.



301-032

## MONTANA 2

Stück Alu L+R

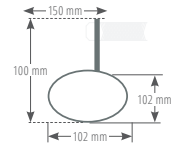

49,95 €  
UVP pro Stück



301-034

Verschiedene Montage-Tutorials jetzt auf YouTube [www.youtube.com](http://www.youtube.com)



## MONTANA

mit LED-Blinker

LED Stück Alu L+R

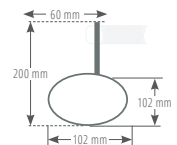

74,95 €  
UVP pro Stück





301-006

99,95 €  
UVP pro Paar

CLASSIC

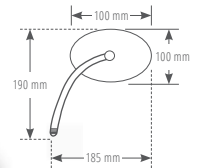

Dieser Artikel  
ist Bestandteil  
der CLASSIC Serie.

301-007

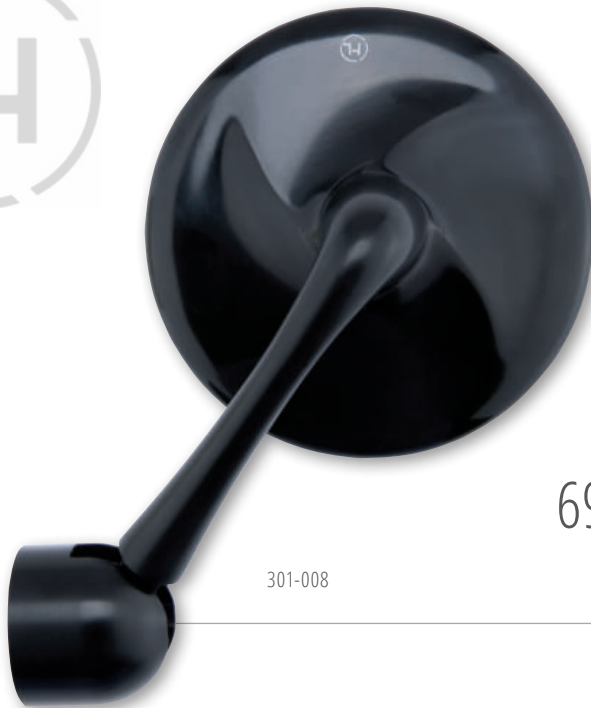

301-008

69,95 €  
UVP pro Stück

CLASSIC

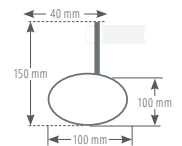

301-009

## TOREZZO

84,95 €  
UVP pro Paar



Lenkerspiegel: 301-586

Dieser Lenkerspiegel ist auch als Verkleidungsspiegel (Art.Nr. 301-582) erhältlich.

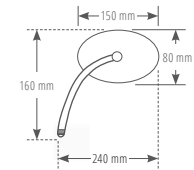

## TOREZZO mit LED-Blinker

99,95 €  
UVP pro Paar



Lenkerspiegel: 301-584

Dieser Lenkerspiegel ist auch als Verkleidungsspiegel (Art.Nr. 301-580) erhältlich.

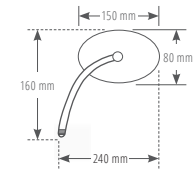



## IRON CROSS



301-110

89,95 €  
UVP pro Paar



301-111

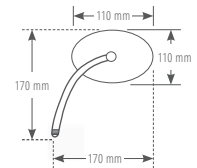

301-112

49,95 €  
UVP pro Stück



301-113

## IRON CROSS

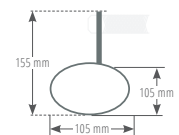

## PHOENIX 1



69,95 €  
UVP pro Paar

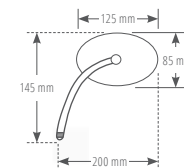

301-590



301-591

## PHOENIX 2



69,95 €  
UVP pro Paar

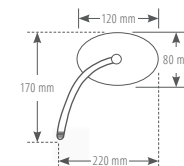

301-592



301-593



301-440

34,95 €  
UVP pro Stück



301-441

**ACTION**

Stück Alu L+R

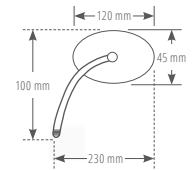

**ACTION**

Stück Alu L+R

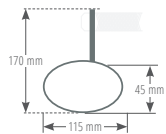

301-448

39,95 €  
UVP pro Stück

**ACTION**

Paar Alu

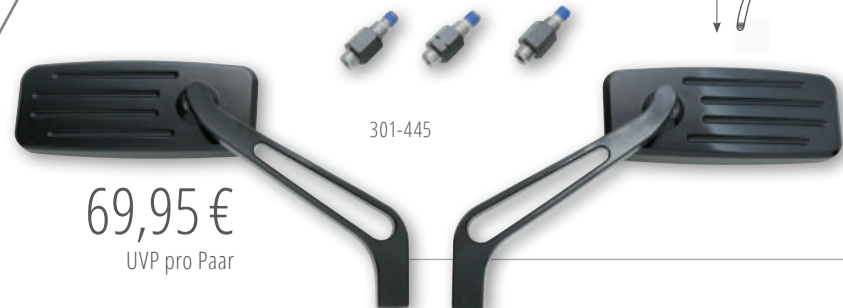
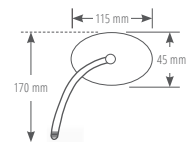

301-445

69,95 €  
UVP pro Paar

## PRATO

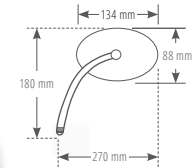

84,95 €  
UVP pro Paar

Lenkerspiegel: 301-051

Dieser Lenkerspiegel ist auch als Verkleidungsspiegel (Art.Nr. 301-050) erhältlich.

## ORLANDO

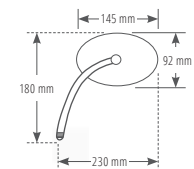

49,95 €  
UVP pro Stück

301-062

301-063



## SEMPIONE



59,95 €  
UVP pro Paar

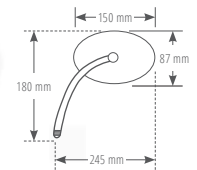

Verkleidungsspiegel: Uni Halter wie 304-020 bis 304-030 müssen separat mitbestellt werden.

301-481

## SEMPIONE



49,95 €  
UVP pro Paar

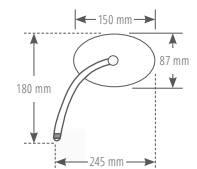

301-480

# COLUMBIA

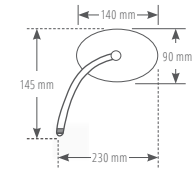

69,95 €  
UVP pro Paar

301-056



Du brauchst Tipps und Tricks? Dann achte einfach auf dieses Icon. Scanne den QR-Code ein und du kommst auf unseren Youtube Channel auf dem Paul und Frank Euch einige Tipps und Tricks geben.



## CNC VERKLEIDUNGSSPIEGEL ADAPTER FB-1



KURZ-304-029

29,95 €  
UVP pro Paar



LANG-304-030



## UNIVERSALADAPTER MIT ABDECKUNG



KURZ-304-023

29,95 €  
UVP pro Paar



LANG-304-024

## UNIVERSALADAPTER



KURZ-304-020

29,95 €  
UVP pro Paar



LANG-304-022



[www.highsider-germany.de](http://www.highsider-germany.de)





—KENNZEICHENHALTER

## Modellspezifische Kennzeichenhalter

Art.-Nr.	Bezeichnung	UVP €
<b>APRILIA</b>		
280-001	RS 125, Bj. 08	69,95
280-003	RS 250, Bj. 99-	69,95
280-002	RS4 125, Tuono V4, Bj.11- / RSV 4 Factory	74,95
280-004	SL 750 Shiver	74,95
280-006	SMV 1200 Dorsoduro	79,95
280-005	SMV 750 Dorsoduro, Bj. 09-11	79,95
280-007	SMV 750 Dorsoduro, Bj. 12-	79,95
<b>BENELLI</b>		
280-080	TNT 899 / 1130	59,95
<b>BMW</b>		
280-100	R 1100 S	58,95
280-101	R 1200 S, Bj. 06-	58,95
280-103	R Nine T	123,95
280-102	S 1000 RR	58,95
<b>BUELL</b>		
280-090	EBR 1190 SX/RX	69,95
<b>DUCATI</b>		
280-155	1199 Panigale	99,95
280-150	848 / 1098 / 1198	89,95
280-157	Hypermotard / Hyperstrada, Bj. 13-	79,95
280-151	Hypermotard 796 / 1100 / 1100 S	79,95
280-165	Hypermotard 950 2019-	79,95
280-153	Monster 1100	129,95
280-160	Monster 1200 R, Bj. 16-	89,95
280-159	Monster 1200, Bj. 14-	89,95
280-163	Monster 1200, Bj. 17-, 821, Bj. 18-	79,95
280-152	Monster 696	99,95
280-158	Monster 821, Bj. 14-	89,95
280-156	Multistrada 1200, Bj. 10-14	69,95
280-164	Panigale V4, Bj. 18-	79,95
280-161	Scrambler 800, Bj. 15- (nicht für classic)	89,95
280-154	Streetfighter 848 / 1098	89,95
280-162	SuperSport , Bj. 17-	79,95
<b>HONDA</b>		
280-608	CB 1000 R	69,95
280-612	CB 500 F/R, Bj. 16-	69,95
280-604	CB 600 Hornet, Bj. 11 / CBR 600 F, Bj. 11	69,95
280-610	CB 650F / CBR650F, Bj. 14-	65,95
280-615	CB 1000 R, Bj. 18-	69,95
280-606	CBR 1000 RR, Bj. 08-09	129,95

Art.-Nr.	Bezeichnung	UVP €
<b>HONDA</b>		
280-607	CBR 1000 RR, Bj. 10-15	69,95
280-613	CBR 1000 RR, Bj. 17-	74,95
280-606	CBR 1000 RR, Bj. 08-09	129,95
280-607	CBR 1000 RR, Bj. 2010-2015	69,95
280-608	CB 1000 R	69,95
280-615	CB 1000 R 2018-	69,95
280-601	CBR 125/250	69,95
280-614	CBR 125, Bj. 18-	79,95
280-616	CB 300 R, Bj. 18-	79,95
280-612	CB 500 F / R 16-	69,95
280-602	CBR 600 RR, Bj. 03-06 / CBR 1000 RR, Bj. 04-07	79,95
280-603	CBR 600 RR, Bj. 07-12	79,95
280-604	CBR 600 Hornet Bj. 11 / CBR 600 F Bj. 11	69,95
280-609	CBR 600 RR, Bj. 13-	89,95
280-610	CB 650F / CBR650F, 14-	65,95
280-618	CB 650 R 19-	79,95
280-605	NC 700 / 750 S/X / Integra 700	69,95
280-611	NC 750 X, Bj. 16-	69,95
280-617	X-ADV, Bj. 17-18	179,95
<b>HUSQVARNA</b>		
280-690	Nuda 900	69,95
280-691	701 Enduro, Bj. 16-18	69,95
280-692	401, ab 2018	79,95
280-693	701, 2018-19	114,95
<b>KAWASAKI</b>		
280-704	ER 6 N & ER 6 F, Bj. -08	58,95
280-705	ER 6 N & ER 6 F, Bj. 09-11	69,95
280-706	ER 6 N & ER 6 F, Bj. 12-	65,95
280-701	Ninja 250 R, Bj. 08-	99,95
280-719	Ninja 300, Bj. 13-	65,95
280-727	Ninja 400, Bj. 18-	65,95
280-718	Versys 1000 / Grand Tourer	59,95
280-725	Versys 1000 ab Bj. 15	59,95
280-718	Versys 1000 ab Bj. 12-16 / Grand Tourer	59,95
280-702	Versys 650 bis Bj. 2009	59,95
280-703	Versys 650, Bj. 10-14	69,95
280-726	Versys 650, Bj. 15-18	69,95
280-729	Z 125 ab Bj. 19	69,95
280-723	Z 650, Bj. 17-	69,95
280-728	Z 900 RS, 18-	65,95

Art.-Nr.	Bezeichnung	UVP €
<b>KAWASAKI</b>		
280-712	Z 1000, Bj. 10- / Z 1000 SX, Bj. 11- / Z 1000 SX Tourer	65,95
280-721	Z 1000, Bj. 14	65,95
280-711	Z 750, Bj. 07- / Z 750 R, Bj. 11- / Z 1000, Bj. 07-09	59,95
280-720	Z 800 /e version, Bj. 13-	65,95
280-713	ZX10R, Bj. 04-05	58,95
280-714	ZX10R, Bj. 06-07	58,95
280-715	ZX10R, Bj. 08-10 / ZX6R Bj. 09-	59,95
280-716	ZX10R, Bj. 11-15	79,95
280-722	ZX10R, Bj. 16-	69,95
280-707	ZX6R, Bj. 03-04 / Z 750, Bj. 04-06 / Z 1000, Bj. 03-06	58,95
280-708	ZX6R, Bj. 05-06	58,95
280-709	ZX6R, Bj. 07-08	79,95
280-730	ZX6R ab Bj. 19	69,95
280-724	Z 900, Bj. 17-	65,95
280-728	Z 900 RS, Bj. 18-	65,95
280-717	ZZR 1400, Bj. -11	59,95
<b>KTM</b>		
280-300	125 Duke / 200 / 390 Duke	129,95
280-310	125 / 390 Duke 17-	79,95
280-307	1290 Super Duke R	79,95
280-306	690 Duke, Bj.12-	79,95
280-302	690 Duke / Supermoto / R, Bj. -11	69,95
280-301	690 SMC / Enduro, Bj. 08-13	69,95
280-308	690 SMC / Enduro, Bj. 14-	69,95
280-319	690 SMC / Enduro, ab Bj. 19	69,95
280-312	790 Duke, Bj. 18-	79,95
280-304	990 Superduke R, Bj. 09-11	69,95
280-303	990 Supermoto	69,95
280-309	RC 125 / 200 / 390	69,95
280-305	RC8, Bj. 08-	69,95
280-311	1290 Super Duke GT, Bj. 17-	69,95
<b>MV AGUSTA</b>		
280-351	Brutale 750 / 1000	69,95
280-352	F3	69,95
280-354	F4, Bj.14-	69,95
280-353	Brutale 675	69,95
280-350	F4, Bj. 10-13	69,95
<b>SUZUKI</b>		
280-817	B-King	79,95
280-801	Gladius SFV 650	92,95

## Zubehör

Art.-Nr.	Bezeichnung	UVP €
<b>SUZUKI</b>		
280-807	GSF 650 Bandit, Bj. 09-	69,95
280-802	GSR 600, Bj. -10	84,95
280-803	GSR 750, Bj. 11-	69,95
280-823	GSXR / S125, Bj. 17-	69,95
280-813	GSXR 1000, Bj. 03-04	58,95
280-814	GSXR 1000, Bj. 05-06	64,95
280-815	GSXR 1000, Bj. 07-08	64,95
280-816	GSXR 1000, Bj. 09-15	69,95
280-821	GSXR 1000, Bj. 17-	79,95
280-818	GSXR 1300 Hayabusa, Bj. 08	59,95
280-808	GSXR 600 / 750, Bj. 04-05	58,95
280-805	GSXR 600 / 750, Bj. 06-07	58,95
280-806	GSXR 600 / 750, Bj. 08-10	59,95
280-811	GSXR 600 / 750, Bj. 11-	59,95
280-822	GSX-S 750, Bj. 17-	79,95
280-819	GSX-S 1000 / F, Bj. 15-	69,95
280-812	SV 650 / SV 1000, Bj. 03-10	58,95
280-820	SV 650, Bj. 16-	69,95
<b>TRIUMPH</b>		
280-404	Daytona 675 / Street Triple, Bj. 13-	65,95
280-403	DAYTONA 675, Bj. -12	79,95
280-402	Speed Triple, Bj. 11-15	69,95
280-406	Speed Triple, Bj. 16-	69,95
280-401	Street Triple, Bj. 07-12	112,95
280-405	Thrupton 900, Bonneville, Scrambler	124,95
<b>YAMAHA</b>		
280-900	MT 125, Bj. 14-	59,95
280-911	FZ 8 / Fazer, Bj. 10- / FZ 1 & F21 Fazer	69,95
280-905	FZ6 / Fazer, Bj. 04-	58,95
280-907	MT 03	109,95
280-913	MT-07, Bj. 14-	69,95
280-919	MT-07 Tracer, Bj. 16-	69,95
280-915	MT-09 Tracer, Bj. 15-	69,95
280-912	MT-09, Bj. 13-	69,95
280-920	MT 09, Bj. 17-	89,95
280-918	MT-10, Bj. 16-	69,95
280-906	XJ6 Diversion	69,95
280-921	XSR 900 ABS, Bj. 16-	79,95
280-908	YZF R1, Bj. 04-06	58,95
280-909	YZF R1, Bj. 07-08	64,95

Art.-Nr.	Bezeichnung	UVP €
<b>YAMAHA</b>		
280-910	YZF R1, Bj. 09-14	69,95
280-916	YZF R1, Bj. 15-	69,95
280-901	YZF R125, Bj. -13	59,95
280-914	YZF R125, Bj. 14-	65,95
280-917	YZF R3, Bj. 15- / MT-03, Bj. 16-	69,95
280-924	YZF R3 ab Bj. 19	69,95
280-903	YZF R6, Bj. 03-05 / YZF R1, Bj. 02-03	58,95
280-904	YZF R6, Bj. 06-	58,95
280-902	YZF R6, Bj. 99-02	58,95
280-922	YZF R6, Bj. 17-	69,95
280-923	YZF R125 ab Bj. 19	69,95

HIGHSIDER™ Kennzeichenhalter bestehen aus schwarz pulverbeschichtetem Stahl, sie sind verstellbar und inklusive Halter für Blinker und Rückstrahler.

Art.-Nr.	Bezeichnung	UVP €
<b>ZUBEHÖR</b>		
280-990	Halteplatte aus Alu für diverse Kennzeicheneuchten.	7,95
280-991	Halteplatte aus Alu mit LED Kennzeichenleuchte 256-013	24,95
280-992	Halteplatte aus Alu mit LED Kennzeichenleuchte 256-064	27,95
280-997	T-Halter für Rückstrahler	3,95
280-999	Haltewinkel mit LED Kennzeichenleuchte 256-033	16,95
<b>BLINKERADAPTER</b>		
280-970	Originalblinker-Adapter Aprilia / BMW / Triumph / Yamaha R125	9,95
280-972	Originalblinker-Adapter Ducati	9,95
280-973	Originalblinker-Adapter Honda	9,95
280-974	Originalblinker-Adapter Kawasaki	9,95
280-975	Originalblinker-Adapter KTM	9,95
280-976	Originalblinker-Adapter Suzuki	9,95
280-977	Originalblinker-Adapter Yamaha	9,95

## Universal Kennzeichenhalter

Sollten Sie Ihren modellspezifischen Halter in der Übersicht nicht finden, so sind unsere Universalhalter eine gute Alternative. Zum Lieferumfang gehören der Kennzeichenhalter inkl. Halter für Blinker und Rückstrahler.

HIGHSIDER™ Kennzeichenhalter Universalhalter Typ 1  
Art.-Nr.: 280-201

45,95 €  
UVP pro Stück

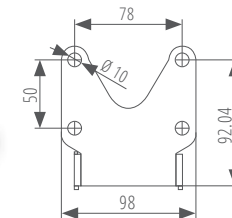

Weitere Universal  
Kennzeichenhalter  
auf der  
nächsten Seite!

## Universal Kennzeichenhalter

HIGHSIDER™ Kennzeichenhalter  
Universalhalter Typ 2 Art.-Nr.: 280-202

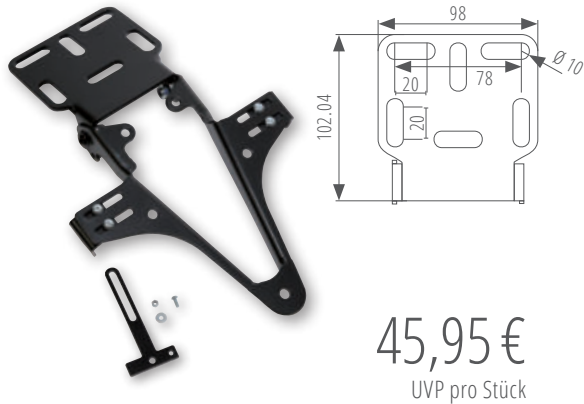

HIGHSIDER™ Kennzeichenhalter  
Universalhalter Typ 3 Art.-Nr.: 280-203

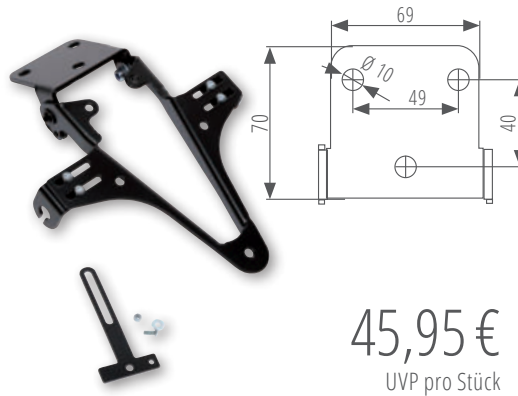

HIGHSIDER™ Kennzeichenhalter  
Universalhalter Typ 4 Art.-Nr.: 280-204



HIGHSIDER™ Kennzeichenhalter  
Universalhalter Typ 5 Art.-Nr.: 280-205

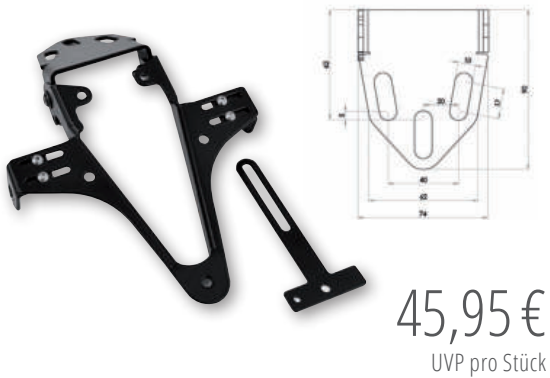

HIGHSIDER™ Kennzeichenhalter  
Universalhalter Typ 6 Art.-Nr.: 280-206

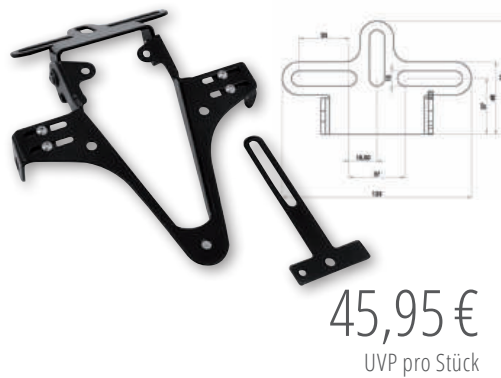

HIGHSIDER™ Kennzeichenhalter  
Universalhalter Typ 7 Art.-Nr.: 280-207





HIGHSIDER™ Kennzeichenhalter  
 Universalhalter Typ 8 Art.-Nr.: 280-208

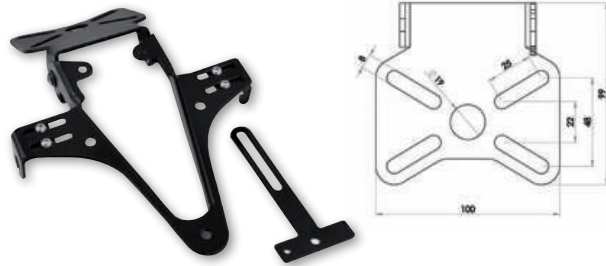

45,95 €  
 UVP pro Stück

## CNC Kennzeichen-Halteplatte

99,95 €  
 UVP pro Stück



282-010

...oder einzeln.



34,95 €  
 UVP pro Stück

Im Set...



129,95 €  
 UVP pro Stück

...Passend dazu:  
 Kennzeichenbeleuchtung

24,95 €  
 UVP pro Stück



256-055

Alle weiteren  
 Infos gibt es auf  
[www.highsider-germany.de](http://www.highsider-germany.de)

## RISER PISTON



149,95 €  
UVP pro Paar



Paar Alu

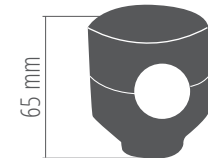

Durchmesser: 58mm  
M12 mm x 1,75  
Für 1 Zoll Lenker

## RISER BALL



149,95 €  
UVP pro Paar



Paar Alu



Breite Lochseite 58mm  
Breite Stirnseite: 40mm  
M12 mm x 1,75  
Für 1 Zoll Lenker



— STYLE DEIN BIKE —



34,95 €  
UVP pro Paar

Dieser Artikel  
ist Bestandteil  
der EP1 Serie.

## ENTERPRISE-EP1

zur Montage von Lenkerendspiegeln

Paar Alu



161-0900

161-0901

161-0902

161-0904

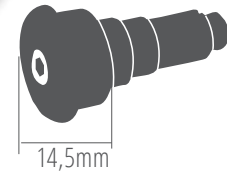

Maße Außen ca. Ø 34,5 mm  
Für Lenkerinnendurchmesser 12-22mm

34,95 €  
UVP pro Paar

Dieser Artikel  
ist Bestandteil  
der WAVE Serie.

## WAVE

zur Montage von Lenkerendspiegeln

Paar Alu



161-0720

161-0721

161-0722

161-0724

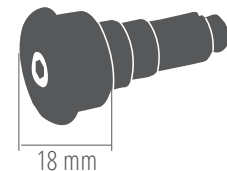

Maße Außen ca. Ø 34,5 mm  
Für Lenkerinnendurchmesser 12-22mm

Du willst keinen Lenkerendspiegel montieren, aber trotzdem schöne Lenkerenden? Dann einfach die passenden CNC Farbring dazu bestellen.



CNC Farbring für Lenkergewichte

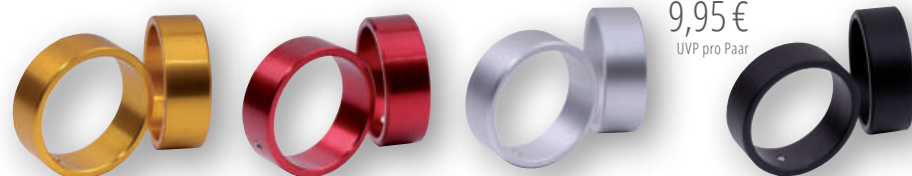

161-0734

161-0732

161-0731

161-0730

9,95 €  
UVP pro Paar





161-015

24,95 €  
UVP pro Paar



161-016

## CURVE

zur Montage von Lenkerendspiegeln

Montagebeispiel



Paar Alu

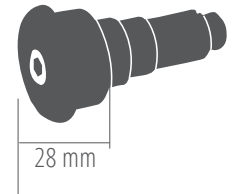

Durchmesser: 25,4 mm  
Maße Außen ca. Ø 35,5 mm  
Für Lenkerinnendurchmesser 12-22mm



161-018

24,95 €  
UVP pro Paar



161-017

## DOT

zur Montage von Lenkerendspiegeln

Montagebeispiel



Paar Alu

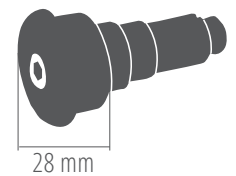

Durchmesser: 25,4 mm  
Maße Außen ca. Ø 35,5 mm  
Für Lenkerinnendurchmesser 12-22mm

## CLASSIC

Paar Alu

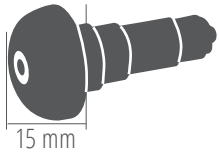

Durchmesser: 35 mm  
Für Lenkerinnendurchmesser 12-22mm



161-061

24,95 €  
UVP pro Paar



161-060

Dieser Artikel  
ist Bestandteil  
der CLASSIC Serie.

## CONERO TYP 2 BLACK EDITION

Zur Montage von Lenkerendenspiegeln

Paar Alu Matt

Für Lenkerinnendurchmesser 12-22mm

Dieser Artikel  
ist Bestandteil  
der CONERO Serie.



161-039

## CONERO

Paar Alu

Für Lenkerinnendurchmesser 12-22mm

34,95 €  
UVP pro Paar

Dieser Artikel  
ist Bestandteil  
der CONERO Serie.

## CONERO TYP 2

Zur Montage von Lenkerendenspiegeln

Paar Alu

Für Lenkerinnendurchmesser 12-22mm

34,95 €  
UVP pro Paar



161-035



161-036

## EVO

zur Montage von Lenkerendspiegeln

Paar Alu

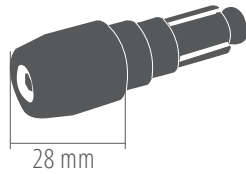

Durchmesser: 25,4 mm

29,95 €  
UVP pro Paar

161-033



161-032



## LENKERADAPTER

zur Montage von Lenkerendspiegeln und -gewichte sowie Hebelschützer.  
Für BMW R1200GS & div. BMW

Paar

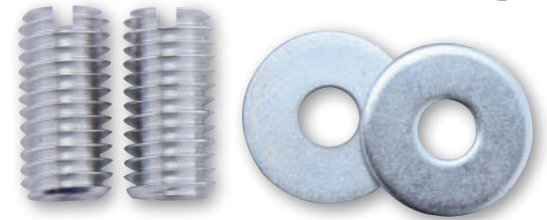

161-038

9,95 €  
UVP pro Paar

## LENKERGEWICHTE

zur Montage von Lenkerendspiegeln

Paar Alu

39,95 €  
UVP pro Paar



161-031



161-030

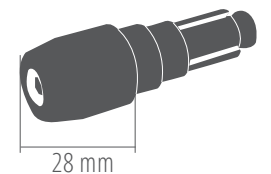

Durchmesser: 25,4 mm

# LENKERGEWICHTE

für diverse Motorrad-Modelle zur Montage von Lenkerendenspiegeln

Für Honda

Paar Alu

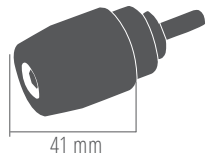

Durchmesser: 25,4 mm



19,95 €  
UVP pro Paar

161-040

Für Kawasaki

Paar Alu

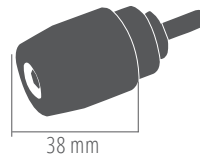

Durchmesser: 25,4 mm



19,95 €  
UVP pro Paar

161-042

Für Suzuki

Paar Alu

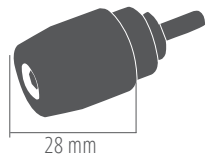

Durchmesser: 25,4 mm



161-044

19,95 €  
UVP pro Paar

Für Yamaha

Paar Alu

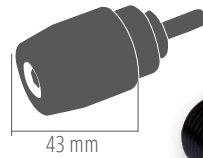

Durchmesser: 25,4 mm



161-046

19,95 €  
UVP pro Paar

Für Yamaha

Paar Alu

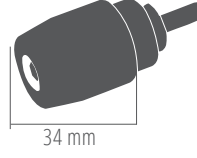

Durchmesser: 25,4 mm



161-047

19,95 €  
UVP pro Paar



## LENKERGRIFFE CONERO

für 7 / 8 Zoll Lenker

Paar

Alu

Dieser Artikel  
ist Bestandteil  
der CONERO Serie.



39,95 €  
UVP pro Paar

315-055

## LENKERGRIFFE CONERO BLACK

für 7 / 8 Zoll Lenker

Paar

Alu

Matt

Dieser Artikel  
ist Bestandteil  
der CONERO Serie.



39,95 €  
UVP pro Paar

315-056

# CNC ABDECKKAPPEN

**Passend für BMW R nine T.** Die schwarz eloxierten Kappen aus Aluminium decken die Rahmenlöcher der BMW RnineT ab. Kombiniert mit polierten Fasen stehen diese Kappen für ein edles, stilvolles Design und passen hervorragend zu unserer CONERO Serie.

2-teilig

Set Alu

**Lieferumfang: 1 Set**

1x Schwingen-Verschlussdeckel, links  
1x Schwingen-Verschlussdeckel, rechts

39,95 €  
UVP pro Set



160-326

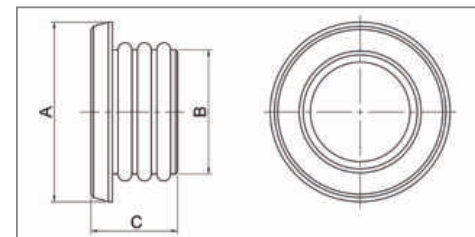

**Maße:**

Verschlussdeckel, links = A: 49 mm, B: 42 mm, C: 13 mm

Verschlussdeckel, rechts = A: 58mm, B: 48 mm, C:10 mm

## 7-teilig



### Lieferumfang: 1 Set, 7-teilig

- 1x Schwingen-Verschlussdeckel, links
- 1x Schwingen-Verschlussdeckel, rechts
- 1x Oberer Schwingen-Verschlussdeckel, rechts
- 2x Unterer Motor-Verschlussdeckel, rechts / links
- 1x Oberer Motor-Verschlussdeckel, vorne
- 1x Oberer Motor-Verschlussdeckel, hinten



119,95 €  
UVP pro Set

160-325

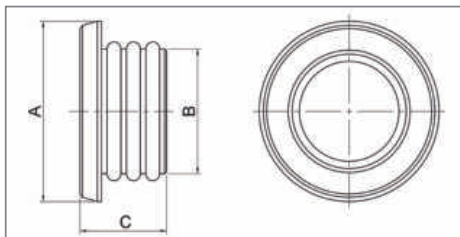

### Maße:

- Schwingen-Verschlussdeckel = A: 49 mm, B:42 mm, C:13 mm
- Schwingen-Verschlussdeckel = A: 58 mm, B:48 mm, C:10 mm
- Oberer Schwingen-Verschlussdeckel = A: 26 mm, B:18 mm, C:12 mm
- Unterer Motor-Verschlussdeckel = A: 32 mm, B:25 mm, C:12 mm
- Oberer Motor-Verschlussdeckel = A: 40 mm, B:32 mm, C:12 mm
- Oberer Motor-Verschlussdeckel = A: 39 mm, B:30 mm, C:12 mm





## Universal CNC Kappe Typ A für den Bremsflüssigkeitsbehälter

Passend für Modelle mit einem Deckeldurchmesser von 61 mm.

19,95 €  
UVP pro Stück



426-404

## Universal CNC Kappe Typ B für den Bremsflüssigkeitsbehälter

Mit Aussparung für die Deckelsicherung. Passend für Modelle mit einem Deckeldurchmesser von 61 mm.

19,95 €  
UVP pro Stück



426-405

## Universal CNC Kappe für den Bremsflüssigkeitsbehälter

Passend für Modelle mit einem Deckeldurchmesser von 42 mm.

19,95 €  
UVP pro Stück



426-406



# CNC DECKEL

## Für den Kupplungs-, und Bremsbehälter

für BMW RnineT ab Bj. 2014 bis 2016



99,95 €  
UVP pro Set

426-400

## Für den Bremsflüssigkeitsbehälter hinten

für z.B. BMW RnineT ab Bj. 2014 und auch div. anderer BMW Modelle.  
Diese CNC Kappe wird direkt auf den Originaldeckel aufgesetzt.



19,95 €  
UVP pro Stück

426-403

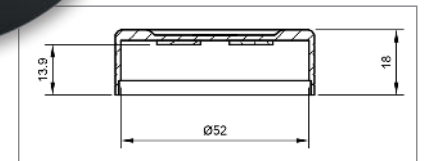

## CNC gefräster Bremsbehälterdeckel

für Triumph 1200 Thruxton ab 2016 & Bobber, Boneville T 100/120

426-401



49,95 €  
UVP pro Stück



426-402

## CNC HEBELSCHÜTZER



119,95 €  
UVP pro Set

## CNC EINSCHWEISSGEHÄUSE

Diese Einschweissgehäuse sind speziell für unsere Einbaumodule STRIPE RUN, APOLLO, PIN, MODUL 1, MODUL 2, SHORTY 2.

19,95 €  
UVP pro Stück

SHORTY 2

STRIPE RUN

MODUL 1

MODUL 2

PIN

APOLLO

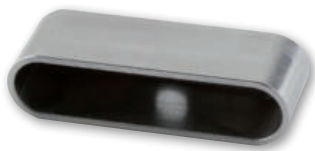

207-600



207-605



207-601



207-602



207-603



207-604





[www.highsider-germany.de](http://www.highsider-germany.de)

## KONTROLLANZEIGE

64,95 €  
UVP pro Stück

Stück Alu

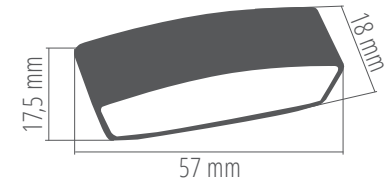

360-230

360-231

## LENKERSCHELLE

passend für die HIGHSIDER™ Kontrollanzeige

Stück Alu

9,95 €  
UVP pro Stück



305-010

305-011

2 x M3-Löcher  
Lochabstand:  
15 mm

## HALTER

um die HIGHSIDER™ Kontrollanzeige direkt an  
60 mm Rundinstrumente (VELONA) zu befestigen

Stück Alu

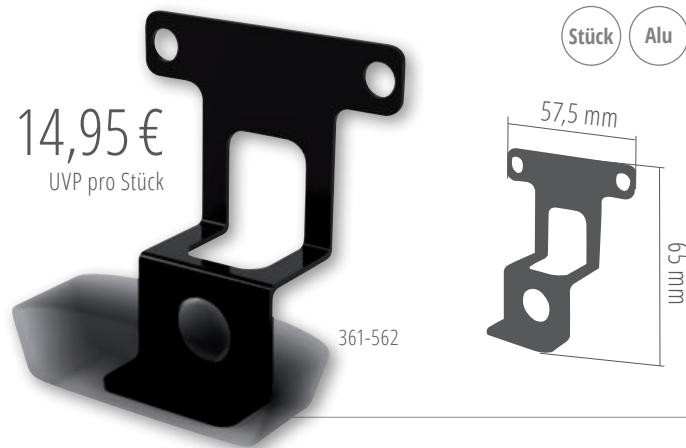

14,95 €  
UVP pro Stück

361-562



## CNC TASTER CLASSIC

Passend für 7/8 und 1 Zoll Lenker. CNC gefräster Schalter mit zwei Tastern. Universal einsetzbar zur Ansteuerung von Lastrelais, Umschaltung diverser Modi an Tachos, etc.

Stück Alu

240-073



49,95 €  
UVP pro Stück

240-072

## CNC TASTERSCHALTER

HIGHSIDER™ komplett CNC gefräster Schalter mit zwei Tastern. Passend für 7/8 Zoll und 1 Zoll Lenker. Universal einsetzbar zur Ansteuerung von Lastrelais, Umschaltung diverser Modi an Tachos, etc.

Stück Alu

240-070



49,95 €  
UVP pro Stück

## TASTER

HIGHSIDER™ Taster für die Bedienung und Steuerung aller Instrumente. Qualitativ hochwertiger Taster, sehr robust und gegen Vibrationen und Spritzwasser geschützt (IP65). Der ergonomische Druckpunkt gibt Rückmeldung bei der Bedienung.

Stück

240-081



12,95 €  
UVP pro Stück

240-080



## TASTER MIT LED LEUCHTRING

Leuchtring in verschiedenen Farben, aus Edelstahl, für die Bedienung und Steuerung aller Instrumente.

Stück LED

240-083

240-084

240-085

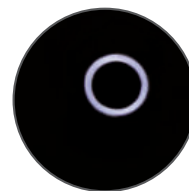
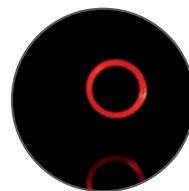

Beleuchtungsbeispiel:



14,95 €  
UVP pro Stück

## OUTDOOR PLANE

Der perfekte Zweiradschutz im Freien: Hochwertige Abdeckplane aus elastischer, reißfester, wasserdichter und UV-beständiger Hightech-Faser. Durch gummierte Nähte bietet die strapazierfähige Motorradabdeckung besten Schutz gegen Regen, Tau oder sonstige Nässe. Die robuste Haube ist mit einem weichen Innenvlies versehen und dadurch auch bei täglichem Gebrauch besonders lackschonend zu verwenden. • eingearbeitete Belüftungsöffnungen • beidseitiger Hitzeschutz • verstärkte Schloss-Öse zur Diebstahlsicherung • verstellbarer Klickverschluss



weiches Innenvlies



eingearbeitete  
Belüftungsöffnungen

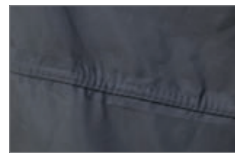

gummierte Nähte



Beschreibung

Größe S

Größe M

Größe L

Größe XL

Größe XXL

	Länge	Breite	Höhe	Art.-Nr.	UVP €
Größe S	183 cm	80 cm	115 cm	380-205	49,95
Größe M	203 cm	80 cm	120 cm	380-206	55,95
Größe L	229 cm	89 cm	125 cm	380-207	57,95
Größe XL	246 cm	94 cm	130 cm	380-208	59,95
Größe XXL	264 cm	105 cm	135 cm	380-209	64,95

## OUTDOOR PLANE CAMOUFLAGE

Der perfekte Zweiradschutz im Freien: Hochwertige Abdeckplane aus elastischer, reißfester sowie wasserdichter und UV-beständiger Hightech-Faser. Durch gummierte Nähte bietet die strapazierfähige Motorradabdeckung besten Schutz gegen Regen, Tau oder sonstige Nässe. Die robuste Haube ist mit einem weichen Innenvlies versehen und dadurch auch bei täglichem Gebrauch besonders lackschonend zu verwenden. • eingearbeiteter Belüftungsöffnungen, beidseitigem Hitzeschutz • verstärkter Schloss-Öse zur Diebstahlsicherung



verstärkte Schloss-Öse



weiches Innenvlies/  
beidseitiger Hitzeschutz



stylishes Design



Beschreibung

Größe L

Größe XL

	Länge	Breite	Höhe	Art.-Nr.	UVP €
Größe L	229 cm	89 cm	125 cm	380-212	59,95
Größe XL	246 cm	94 cm	130 cm	380-213	69,95

## OUTDOOR PLANE HEAVY DUTY

Der perfekte Zweiradschutz im Freien: Hochwertige Abdeckplane aus elastischer, reißfester sowie wasserdichter und UV-beständiger Hightech-Faser. Durch gummierte Nähte bietet die strapazierfähige Motorradabdeckung besten Schutz gegen Regen, Tau oder sonstige Nässe. Die extrem robuste und schwere Haube ist mit einem weichen Innenvlies versehen und dadurch auch bei täglichem Gebrauch besonders lackschonend zu verwenden. Durch das höhere Gewicht liegt sie gleichmäßig auf dem Motorrad auf und ist weniger windanfällig.

- eingearbeiteter Belüftungsöffnungen, beidseitigem Hitzeschutz.
- verstärkter Schloss-Öse zur Diebstahlsicherung



weiches Innenvlies/  
beidseitiger Hitzeschutz



Robustes Material



inkl. stilyschem Beutel



Beschreibung

Größe M

Größe L

Größe XL

Größe XXL

Länge

203 cm

229 cm

246 cm

264cm

Breite

80 cm

89 cm

94 cm

105 cm

Höhe

120 cm

125 cm

130 cm

135 cm

Art.-Nr.

380-214

380-210

380-211

380-215

UVP €

44,95

57,95

59,95

59,95

## INDOOR PLANE

Ein trockener Abstellplatz für Ihr Motorrad ist die halbe Miete. Einen perfekten Schutz bieten jedoch unsere HIGHSIDER™ Indoor-Abdeckplanen. Das hochelastische Textilmaterial passt sich ideal den Konturen Ihres Zweirades an. Eng anliegend, umhüllt und schützt lackschonendes, weiches Innenmaterial das Bike. Für den optimalen Sitz der edlen Stretchhaube sorgt zudem ein rundum verlaufender Gummizug. So haben Staub und Schmutz keine Chance. Das leuchtende Rot, geteilt durch einen kontrastreichen schwarzen Balken auf der Oberseite, bringt darüber hinaus einen angenehmen Farbtupfer ins triste Garagen-Grau.



Beschreibung

Größe S

Größe M

Größe L

Größe XL

Länge

160 cm

183 cm

203 cm

228 cm

Breite

65 cm

80 cm

89 cm

99 cm

Höhe

110 cm

115 cm

119 cm

124 cm

Art.-Nr.

380-544

380-545

380-546

380-547

UVP €

29,95

32,95

34,95

39,95



[www.highsider-germany.de](http://www.highsider-germany.de)

---

## Impressum

Herausgeber  
Paaschburg & Wunderlich GmbH  
Am Alten Lokschruppen 10 a | D-21509 Glinde  
T. +49 (0) 40/248 277 - 0 | F. +49 (0) 40/248 277 - 79  
sales@pwonline.de | www.pwonline.de

Geschäftsführer  
Dr. Oliver Moosmayer  
Reg.-Nr. (Hamburg): HRB 46289  
Steuer-Nr.: 30 | 291 | 06380  
Ust-IdNr. | VAT ID no.: DE118679499

Alle Preise: Stand 01/08/2019. Irrtümer und Änderungen vorbehalten. Die Reproduktion des Inhalts, auch auszugsweise, darf nur mit Genehmigung erfolgen. Farbabweichungen sind durch das Druckverfahren möglich. Alle Urheberrechte liegen bei der Firma Paaschburg & Wunderlich GmbH.