



Wood Trick®  
A NEW WORLD OF ART

**RU** Внимание! **UKR** Увага! **ENG** Attention! **DEU** Achtung! **FRA** Attention! **POL** Uwaga! **SPA** Atención! **ITA** Attenzione!



**RU** Не поджигать! **UKR** Не підпалювати! **ENG** Do not set fire to it! **DEU** Nicht anzünden! **FRA** Ne pas allumer! **POL** nie podpalaj! **SPA** No prender fuego! **ITA** Non dare fuoco!



**RU** Осторожно! Острые детали! **UKR** Обережно! Гострі деталі! **ENG** Caution! Sharp parts! **DEU** Vorsichtig! Scharfe Details! **FRA** Attention Détails tranchants! **POL** Uwaga! Ostre szczegóły! **SPA** Cuidado! Piezas cortantes! **ITA** Attenzione! Dettagli nitidi!

**RU** Рекомендация: если возникли сложности при скреплении деталей, обработайте зубочистки парафином. **UKR** Рекомендація: якщо виникли складнощі при скріпленні деталей, обробіть зубочистки парафіном. **ENG** Recommendation: if you have difficulty in connecting parts, treat toothpicks with paraffin. **DEU** Empfehlung: Wenn Sie Schwierigkeiten haben, Teile zu verbinden, behandeln Sie Zahnstocher mit Paraffin. **FRA** Recommandation: si vous avez des difficultés pièces de fixation, traitez les cure-dents avec de la paraffine. **POL** Zalecenie: jeśli masz trudności z połączeniem części, obsługiwać wykałaczki parafiną. **SPA** Recomendación: si tiene dificultades para fijar piezas, trate mondadientes con parafina. **ITA** Raccomandazione: in caso di difficoltà nel fissare le parti, trattare gli stuzzicadenti con paraffina.

**RU** Конструктор не требует применения клея. **UKR** Конструктор не вимагає застосування клею. **ENG** The assembling of constructor does not require to use glue. **DEU** Für die Montage des Konstruktors ist kein Klebstoff erforderlich. **FRA** Aucune colle n'est nécessaire pour monter le constructeur. **POL** Montaż konstruktora odbywa się bez kleju. **SPA** El montaje constructor no requiere el uso de pegamento. **ITA** L'assemblaggio non richiede l'uso di colla.

**RU** Хрупкие детали! При извлечении элементов конструктора из карты будьте аккуратны! **UKR** Крихкі деталі! Під час вилучення конструктора з карти будьте обережні! **ENG** Fragile details! Be careful when removing the constructor from the card! **DEU** Zerbrechliche Details! Seien Sie vorsichtig, wenn Sie den Konstruktor von der Karte entfernen! **FRA** Détails fragiles! Faites attention en retirant les éléments de la construction de la carte! **POL** Kruche szczegóły! Przedmioty należy wyjmować z karty ostrożnie! **SPA** Detalles frágiles! Sea prudente al sacar elementos de mecano del tarjeta! **ITA** Dettagli fragili! Gli elementi vanno estratti dalla scheda con cautela!

**RU** Все элементы входящие в зацепление необходимо зачистить наждачной бумагой и смазать парафином. **UKR** Всі елементи, що входять у зачеплення необхідно зачистити наждачним папером і змастити парафіном. **ENG** All elements that interlock must be sanded with sandpaper and greased with paraffin. **DEU** Alle eingreifenden Teile müssen mit Sandpapier gereinigt und mit Paraffin eingefettet werden. **FRA** Il faut nettoyer tous les éléments de l'accrochage à l'aide du papier-meri et les traiter avec de la paraffine. **POL** Wszystkie zaczepione elementy należy oczyścić papierem ściernym i nasmarować parafiną. **SPA** Todos los elementos que se enganchan deben limpiarse con papel de lija y engrasarse con parafina. **ITA** Tutti gli elementi agganciati devono essere puliti con carta vetrata e ingrassati con paraffina.

Wood Trick  
A NEW WORLD OF ART

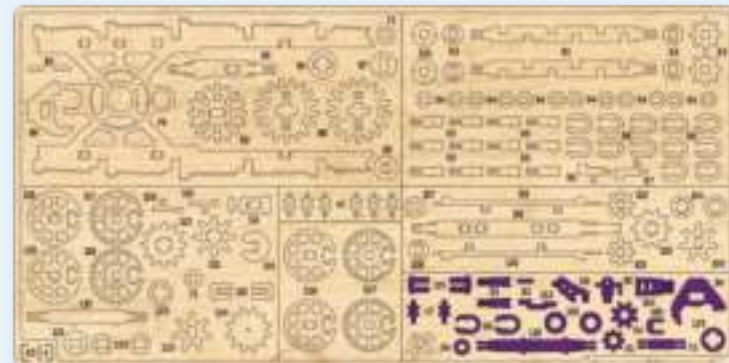

**RU** Запасные части. **UKR** Запасні деталі. **ENG** Spare parts. **DEU** Ersatzteile. **FRA** Pièces de rechange. **POL** Części zamienne. **SPA** Repuestos. **ITA** Pezzi di ricambio.

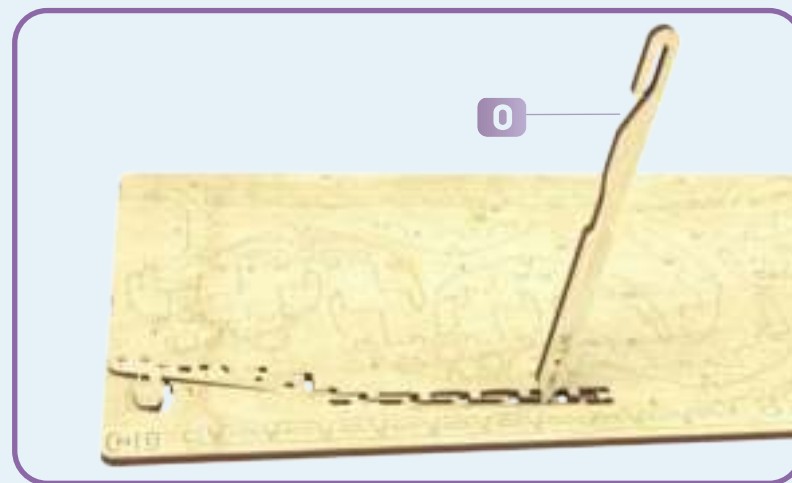

**RU** Вспомогательный инструмент для сборки или измерения расстояний. **UKR** Допоміжний інструмент для збірки або вимірювання відстаней. **ENG** Auxiliary tool for assembling or measuring distances. **DEU** Hilfswerkzeug zum Montieren oder Messen von Abständen. **FRA** Outil auxiliaire pour assembler ou mesurer des distances. **POL** Narzędzie pomocnicze do montażu lub pomiaru odległości. **SPA** Herramienta auxiliar para ensamblar o medir distancias. **ITA** Strumento ausiliario per l'assemblaggio o la misurazione delle distanze.



**RU** Условные обозначения. **UKR** Умовні позначення. **ENG** Symbolic notations. **DEU** Erläuterungen. **FRA** Légende. **POL** Notacje symboliczne. **SPA** Notaciones simbólicas. **ITA** Notazioni simboliche.



**RU** Удалить заусеницы. **UKR** Видалити задирки. **ENG** Remove burrs. **DEU** Niednägel entfernen. **FRA** Enlever les bavures. **POL** Usuń zadziory. **SPA** Quitar rebabas. **ITA** Eliminare le bave.



**RU** Обломать с двух сторон. **UKR** Обломати з двох сторін. **ENG** Break off from both sides. **DEU** Brechen Sie einen Zahnstocher auf beiden Seiten ab. **FRA** Casser un cure-dent des deux côtés. **POL** Oblomaj wykałaczkę po obu stronach. **SPA** Romper un palillo de dientes en ambos lados. **ITA** Rompere uno stecchino su entrambi i lati.



**RU** Сборка в зеркальном отражении. **UKR** Збірка в дзеркальному відображенні. **ENG** Assembly in mirror reflection. **DEU** Montage in spiegelreflexion. **FRA** Assemblage en réflexion spéculaire. **POL** Montaż w odbiciu lustrzanym. **SPA** Montaje en reflexión especular. **ITA** Assemblaggio in riflessione speculare.



**RU** Отрезать зубочистку. **UKR** Відрізати зубочистку. **ENG** Cut off a toothpick. **DEU** Schneiden Sie einen Zahnstocher ab. **FRA** Couper la cure-dent. **POL** Odetniij wykałaczkę. **SPA** Cortar un palillo de dientes. **ITA** Tagliare lo stecchino.

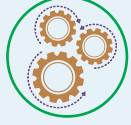

**RU** После сборки, механизм нужно разработать. **UKR** Після складання, механізм потрібно розробити. **ENG** After being assembled, the mechanism should be activated. **DEU** Nach der Montage sollte der Mechanismus ausgearbeitet werden. **FRA** Après l'assemblage, le mécanisme doit être travaillé. **POL** Po montażu mechanizm należy rozpracować. **SPA** Hace falta poner en operación el mecanismo después de su montaje. **ITA** Dopo l'assemblaggio, il meccanismo deve essere sviluppato.



**RU** Смазать парафином. **UKR** Змастити парафіном. **ENG** Lubricate with paraffin. **DEU** Mit dem Paraffin schmieren. **FRA** Lubrifier à la paraffine. **POL** Nasmaruj parafiną. **SPA** Lubricar con parafina. **ITA** Lubrificare con paraffina.



**RU** Деталь должна свободно вращаться. **UKR** Деталь повинна вільно обертатися. **ENG** The part must rotate freely. **DEU** Das detail muss sich frei drehen. **FRA** L'élément doit tourner librement. **POL** Część powinna swobodnie obracać się. **SPA** La pieza debe girar libremente. **ITA** Il dettaglio deve ruotare liberamente.



**RU** Конструктор может в некоторых местах туго соединяться, для того, чтобы собранная модель имела прочность и надёжность. Для более удобной сборки конструктора, рекомендуем использовать плоскогубцы и канцелярский нож. **UKR** Конструктор може в деяких місцях туго з'єднатися, для того, щоб зібрана модель мала міцність та надійність. Для більш зручної збірки конструктора, рекомендуємо використовувати плоскогубці та канцелярський ніж. **ENG** Design kit can be tightly connected in some places, so that the assembled model has solidity and reliability. We recommend using pliers and box cutter for a more convenient design kit assembly. **DE** Der Konstruktor kann an einigen Stellen keine gute Verbindung herstellen, so daß das zusammengebaute Modell eine ausreichende Festigkeit und Zuverlässigkeit aufweist. Für eine bequemere Montage des Konstrukteurs empfehlen wir die Verwendung einer Zange und eines Schreibwarenmessers. **FR** Le jeu de construction peut être étroitement connecté à certains endroits, pour que le modèle assemblé soit solide et fiable. Pour un assemblage plus pratique de jeu de construction, nous vous recommandons d'utiliser une pince et un couteau à papeterie. **IT** Le jeu de construction peut être étroitement connecté à certains endroits, pour que le modèle assemblé soit solide et fiable. Pour un assemblage plus pratique de jeu de construction, nous vous recommandons d'utiliser une pince et un couteau à papeterie. **PL** Le jeu de construction peut être étroitement connecté à certains endroits, pour que le modèle assemblé soit solide et fiable. Pour un assemblage plus pratique de jeu de construction, nous vous recommandons d'utiliser une pince et un couteau à papeterie.

**RU** Внимание! Для корректной работы данной модели, необходимо при сборке тщательно зачищать и смазывать парафином все трущиеся детали. Все механизмы должны свободно вращаться. **UA** Увага! Для коректної роботи даної моделі, необхідно при збірці ретельно зачищати, змащувати парафіном усі деталі, які труться. Усі механізми повинні вільно обертатися. **EN** Warning! For the correct operation of this model, it is necessary to clean carefully and to lubricate all rubbing parts with paraffin during assembly. All mechanisms must rotate freely. **FR** Attention! Pour le bon fonctionnement de ce modèle, il est nécessaire lors du montage de nettoyer et lubrifier soigneusement toutes les pièces à friction avec de la paraffine. Tous les mécanismes doivent tourner librement. **SP** ¡Atención! Para el funcionamiento adecuado de este modelo a la hora de ensamblaje se recomienda alisar y lubricar cuidadosamente con parafina todos los detalles frótantes. Todos los mecanismos deben girar libremente. **IT** Attenzione! Per il corretto funzionamento di questo modello, durante il montaggio, è necessario pulire e lubrificare accuratamente tutte le parti di sfregamento con paraffina. Tutti i meccanismi devono ruotare liberamente. **DE** Hinweis! Für einen korrekten Betrieb dieses Modells ist bei dem Zusammenbau erforderlich, alle Reibteile sorgfältig auszuschrägen und mit Paraffin zu schmieren. Alle Bauteile sollen sich frei drehen. **PL** Uwaga! Aby ten model działał prawidłowo, podczas montażu wszystkie detale trące muszą być dokładnie oczyszczone i nasmarowane parafiną. Wszystkie mechanizmy muszą się swobodnie obracać.



**RU** Завязать узел. **UKR** Зав'язати вузол. **ENG** Tie a knot. **DEU** Den knoten anknüpfen. **FRA** Faire un noeud. **POL** Zawiąź węzeł. **SPA** Hacer un nudo. **ITA** Fare un nodo.



**RU** Сборка окончена. **UKR** Збірка закінчена. **ENG** Assembly is completed. **DEU** Montage abgeschlossen. **FRA** Assemblée terminée. **POL** Montaż zakończony. **SPA** Ensamblaje completada. **ITA** L'assemblaggio è finito.



**RU** Большая резинка. **UKR** Велика резинка. **ENG** Large rubber band. **DEU** Großes Gummiband. **FRA** Grand élastique. **POL** Duża gumka. **SPA** Tira de goma grande. **ITA** Gomma grande.



**RU** Ввести механизм. **UKR** Звести механізм. **EN** Start the mechanism. **DE** Starten Sie den Mechanismus. **FR** Démarrer le mécanisme. **PL** Zapusc mechanizm. **SP** Dar vuelta el mecanismo. **IT** Avvia il meccanismo.



**RU** Широкая резинка. **UKR** Широка резинка. **ENG** Wide rubber band. **DEU** Breites Gummiband. **FRA** Large bande élastique. **POL** Szeroka gumka. **SPA** Banda de goma ancha. **ITA** Ampio elastico.



**RU** Обратит внимание! **UKR** Звернути увагу! **ENG** Note! **DEU** Aufgepasst! **FRA** Faites attention! **POL** Uwaga! **SPA** ¡Presta atención! **ITA** Presta attenzione!

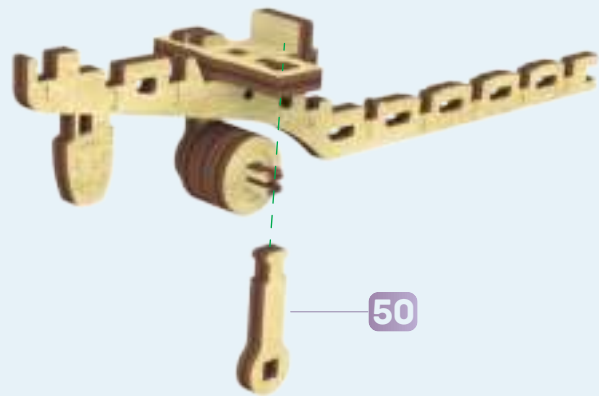
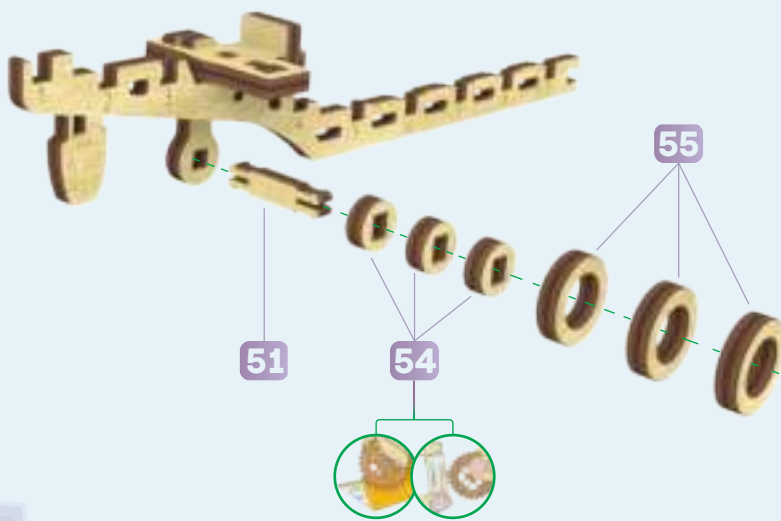
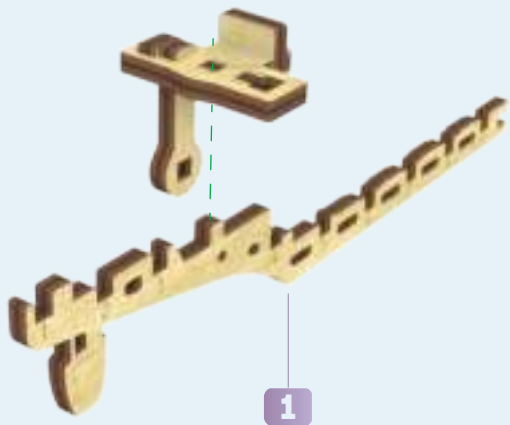
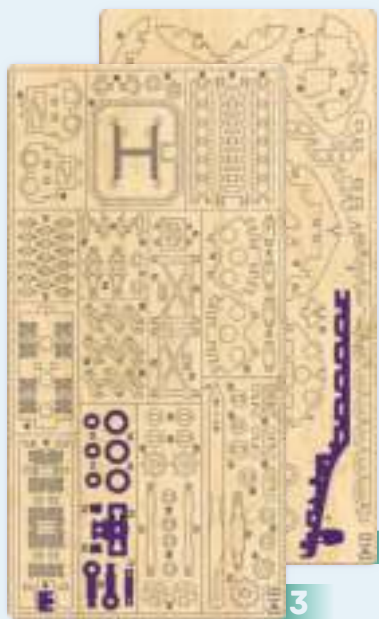
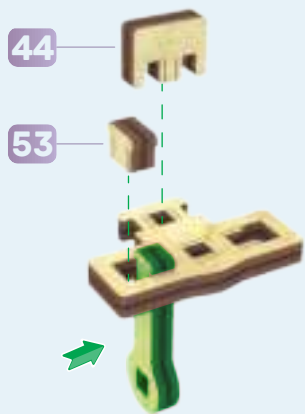



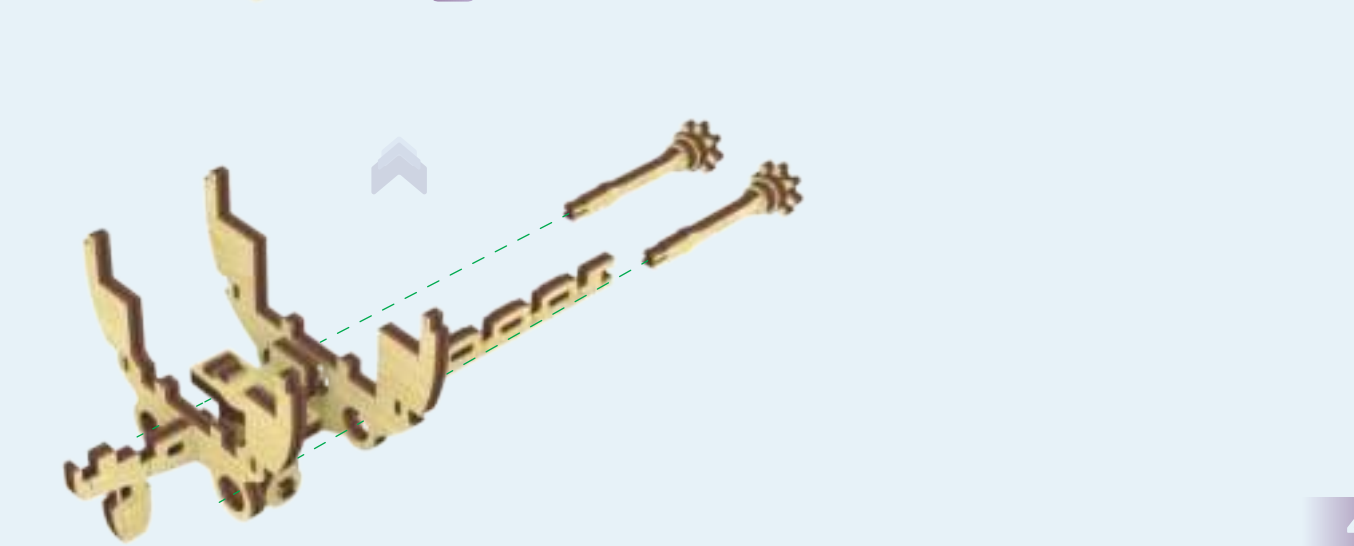
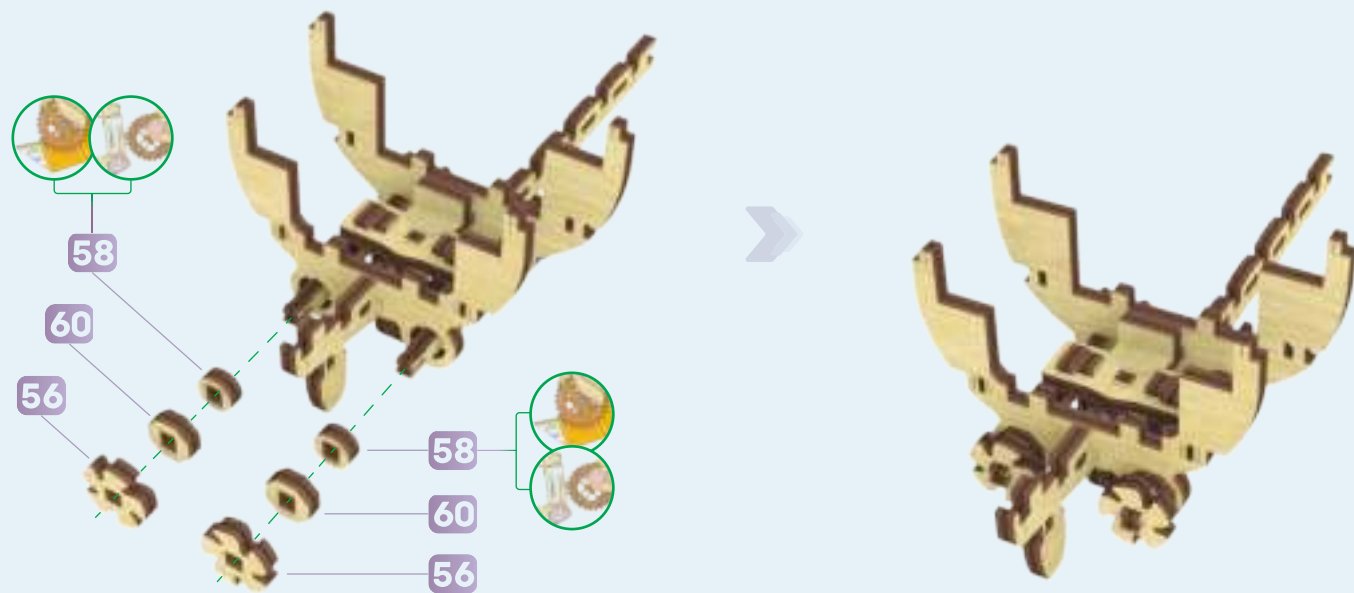
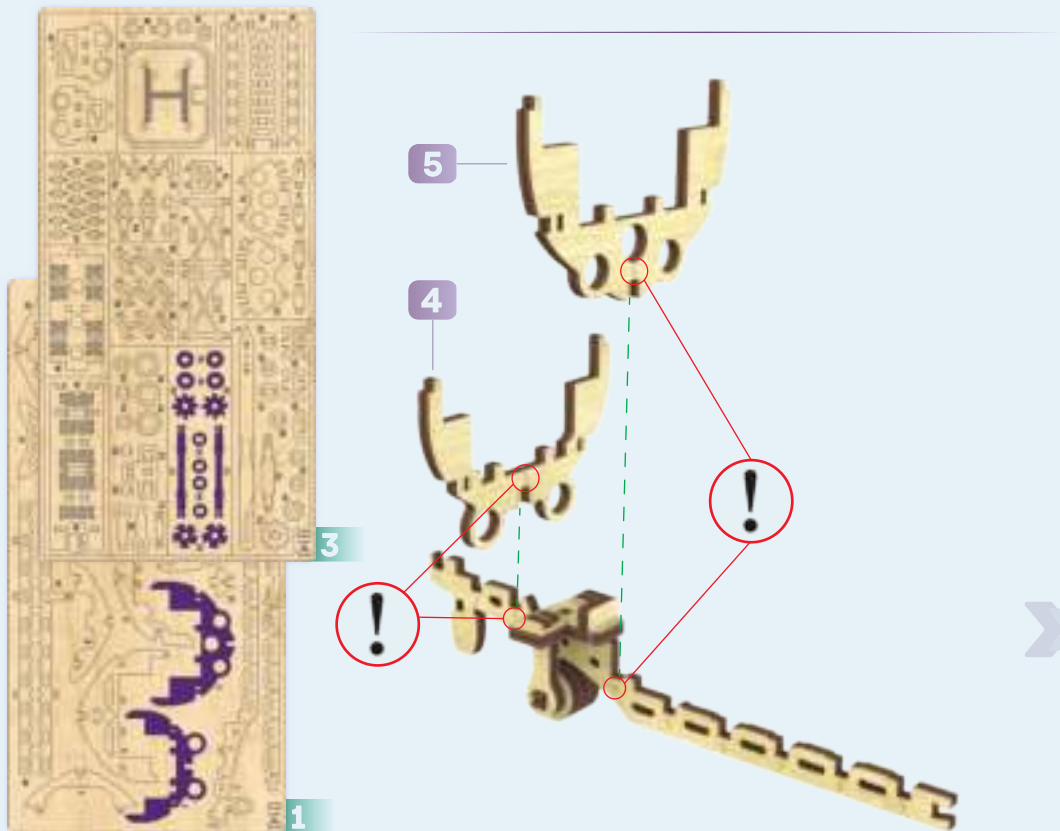
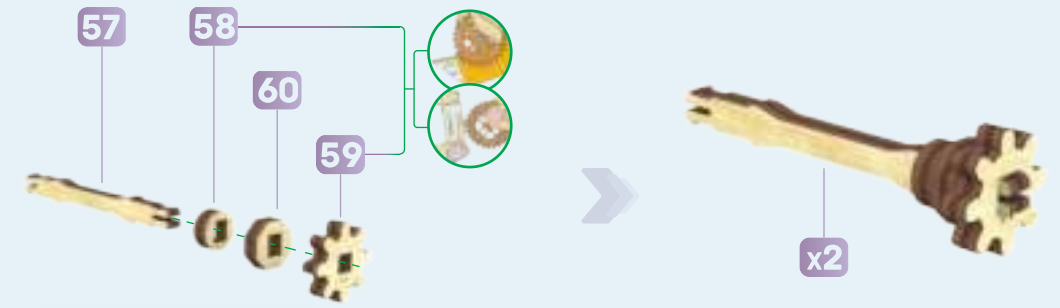

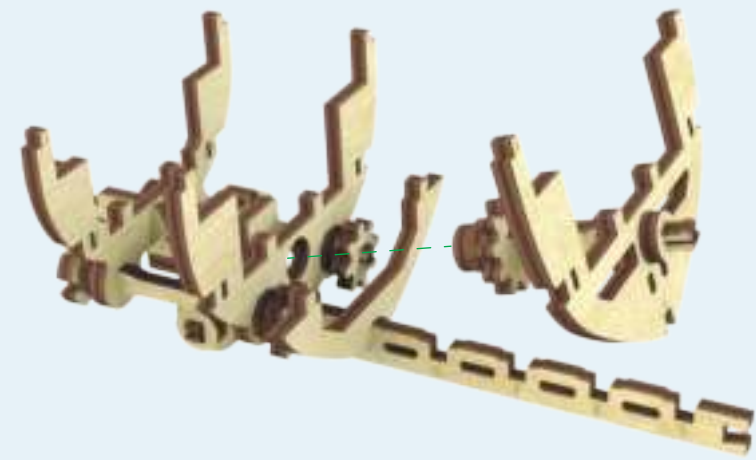
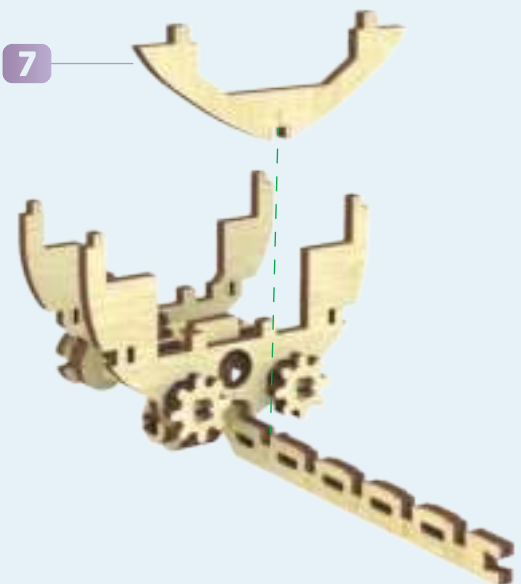
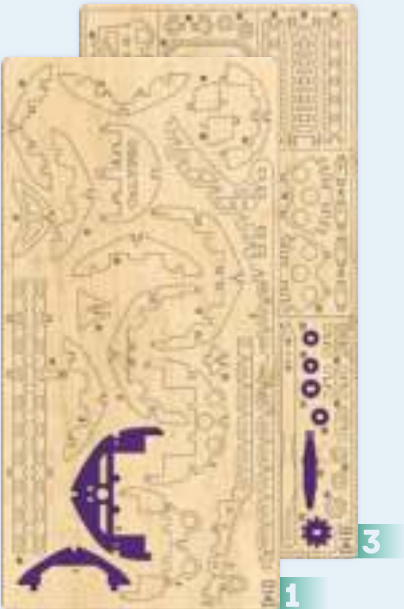
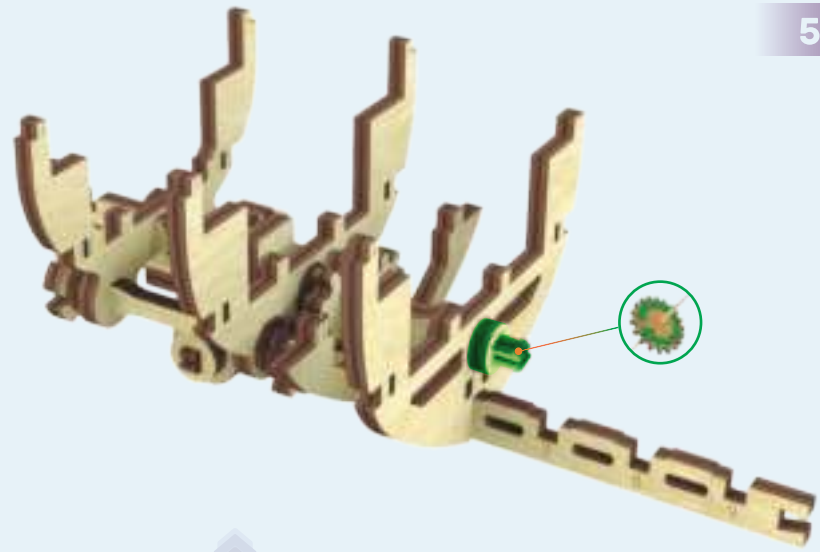
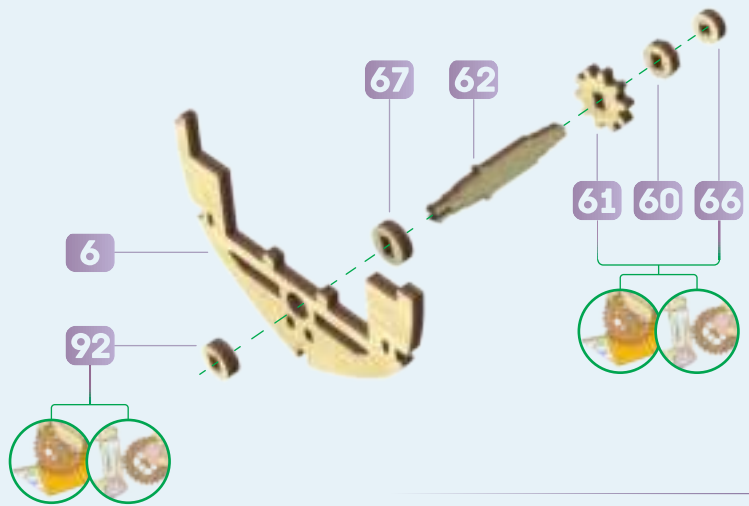



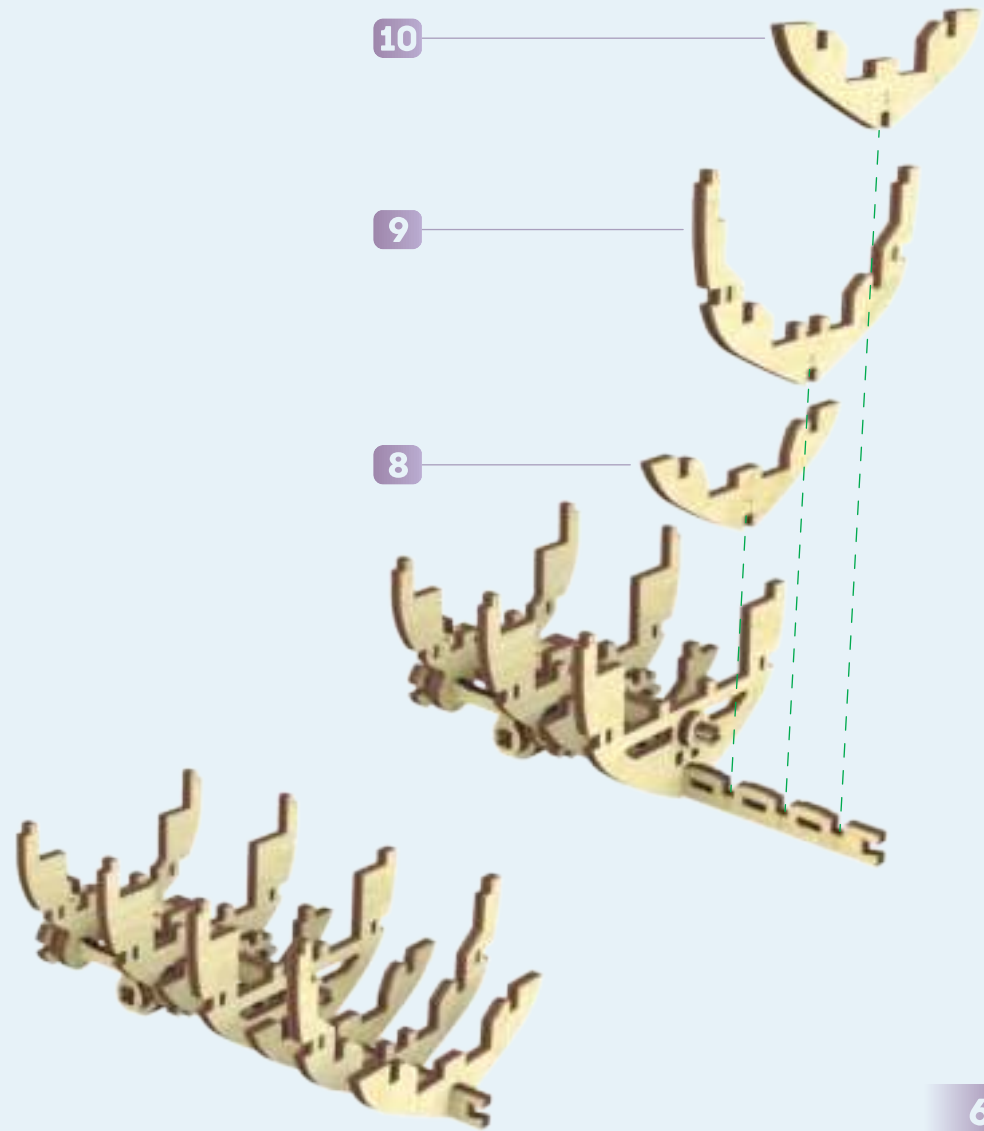
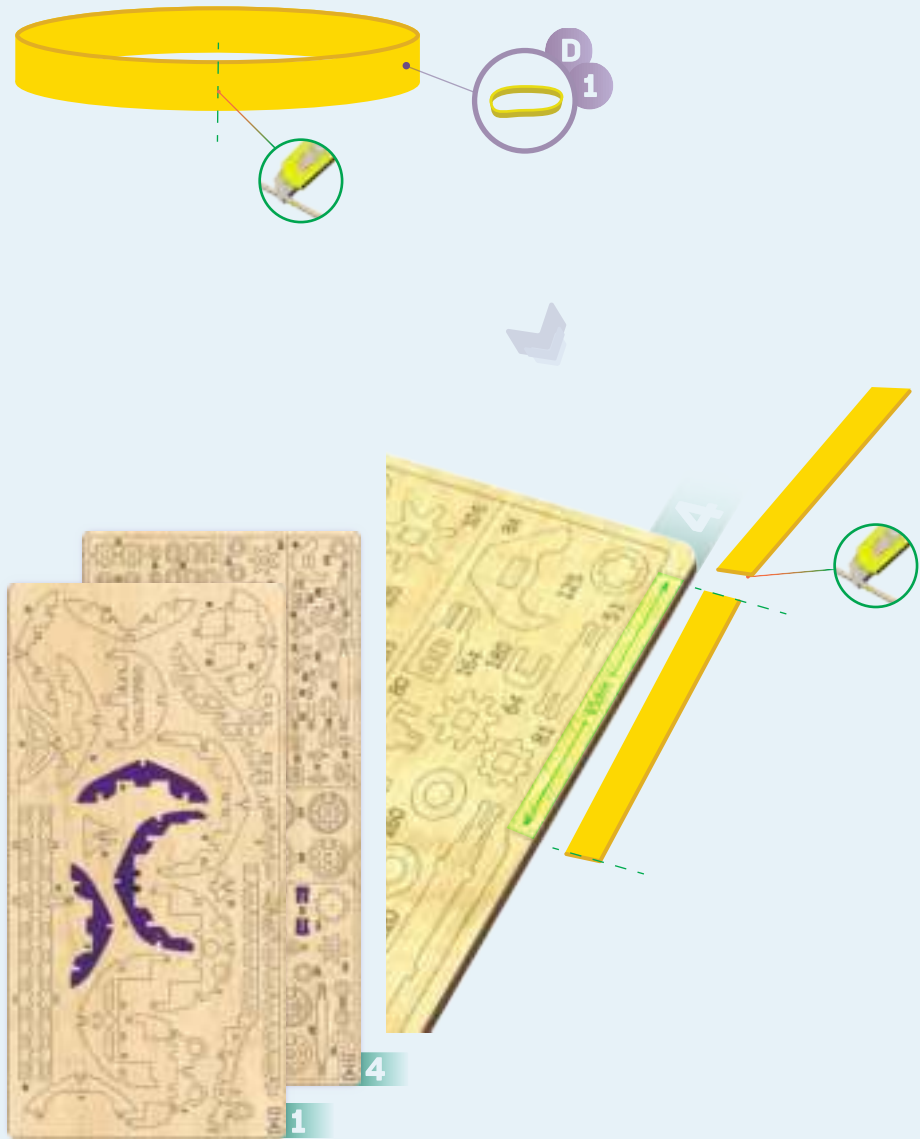



7



4



**RU** При использовании деталей 116, 117, 118, 119 колёса будут создавать покачивание корабля при движении. Для ровного хода корабля, при сборке колёс используйте детали 317, 318.

**UA** При використанні деталей 116, 117, 118, 119 колеса будуть створювати ефект погойдування корабля при русі. Для рівного ходу корабля, при збірці коліс використовуйте деталі 317, 318.

**EN** When using parts 116, 117, 118 and 119, the wheels will create rocking of the ship while moving. For a smooth running of the ship, use parts 317 and 318 when assembling the wheels.

**DE** Bei Verwendung der Teile 116, 117, 118, 119 verursachen die Räder ein Wackeln des Schiffes während des Laufes. Verwenden Sie die Teile 317 und 318 beim Zusammenbau der Räder, damit das Schiff reibungslos läuft.

**FR** Lors de l'utilisation des pièces 116, 117, 118, 119, les roues créeront le balancement du navire lors du déplacement. Pour un bon fonctionnement du navire, veuillez utiliser les pièces 317, 318 lors de l'assemblage des roues.

**ITL** Quando si utilizzano le parti 116, 117, 118, 119, le ruote creeranno l'oscillazione della nave durante il movimento. Utilizzare le parti 317, 318 quando si assemblano le ruote, per un buon andamento della nave.

**SP** Las ruedas harán que la nave se balancee al moverse cuando se utilizan las piezas 116, 117, 118, 119. Utiliza las piezas 317, 318 al montar las ruedas para que la nave avance bien.

**PL** Podczas wykorzystywania części 116, 117, 118, 119 koła będą powodować kotysanie się statku podczas ruchu. Użyj części 317, 318 podczas montażu kół, aby statek działał płynnie.

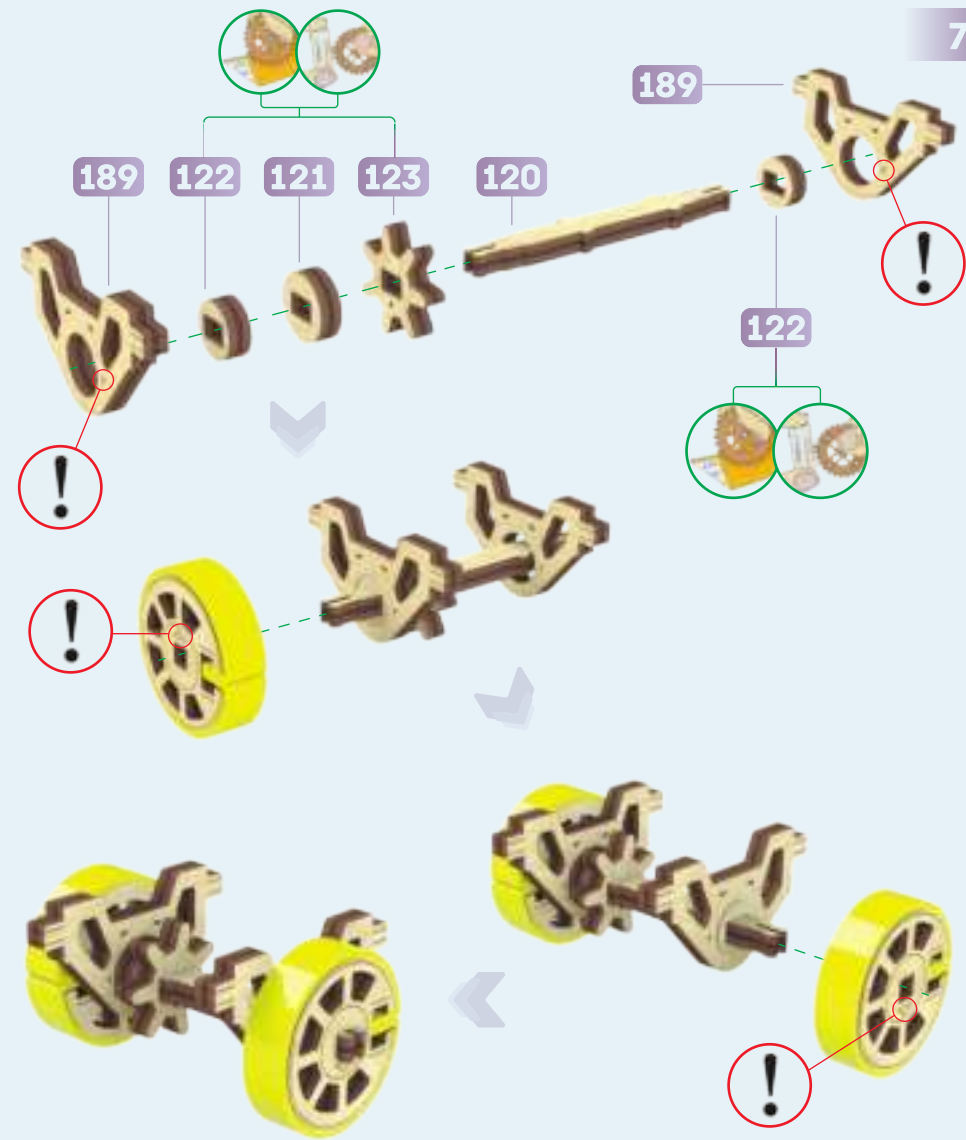



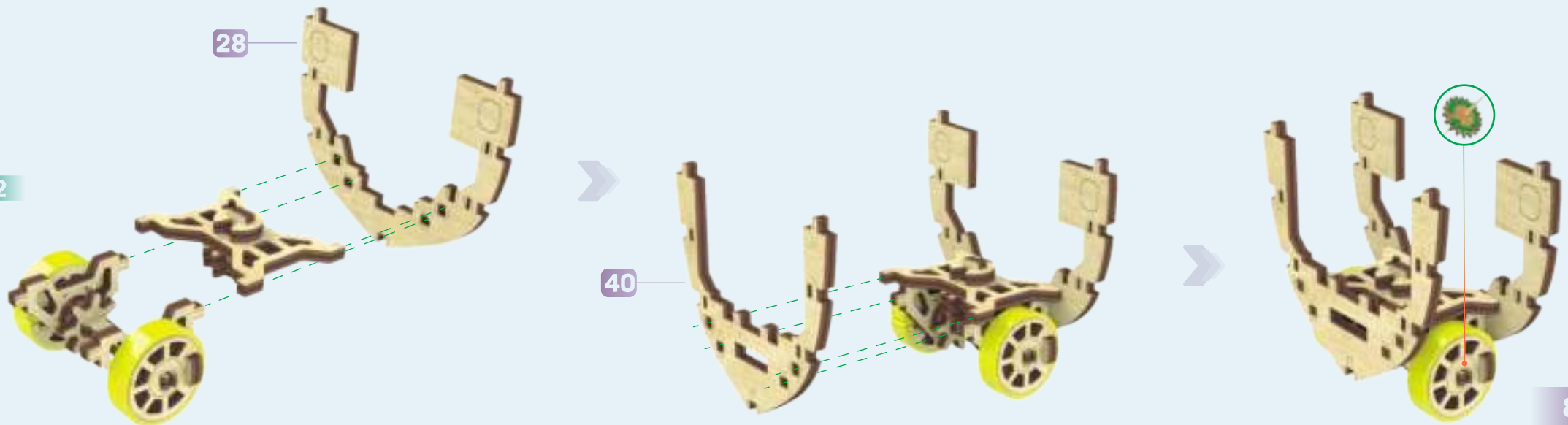
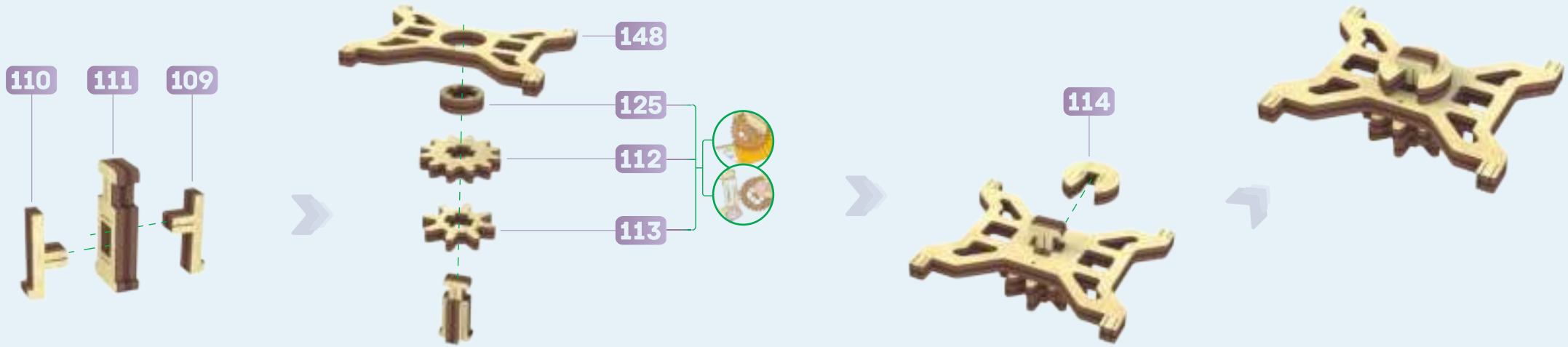
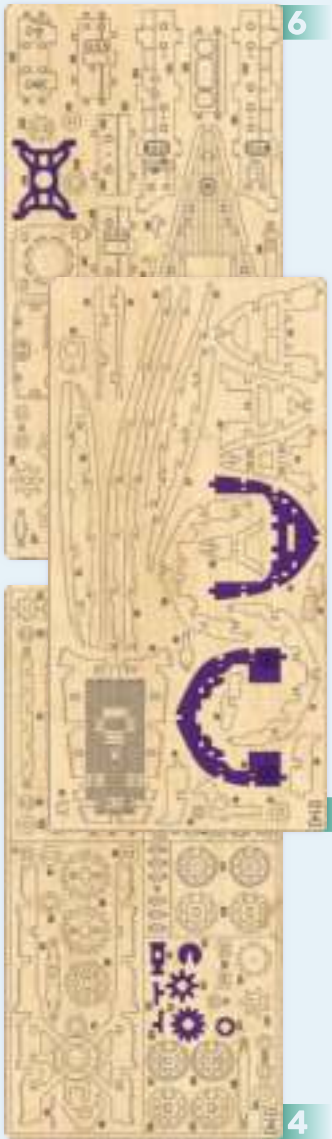

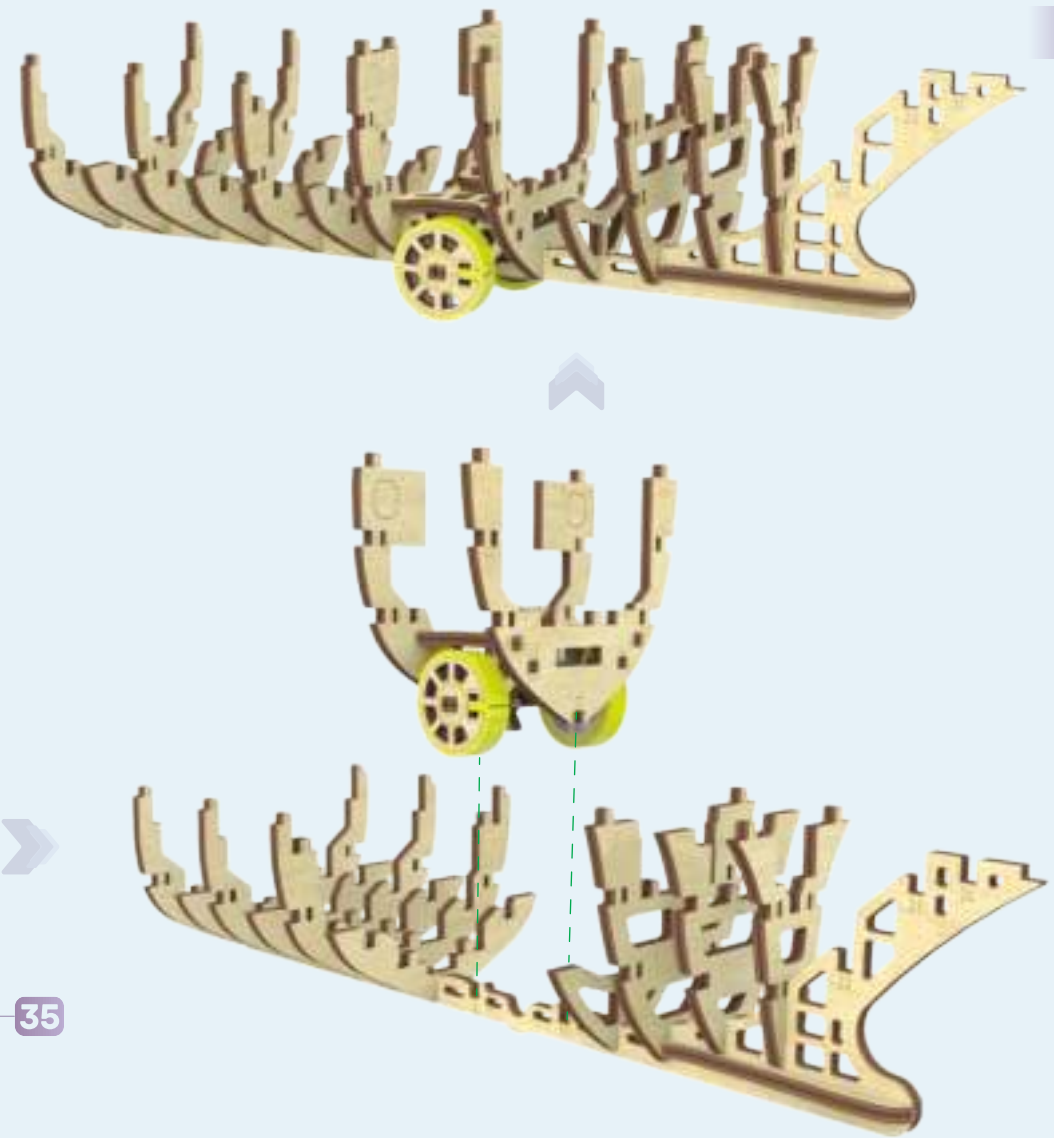
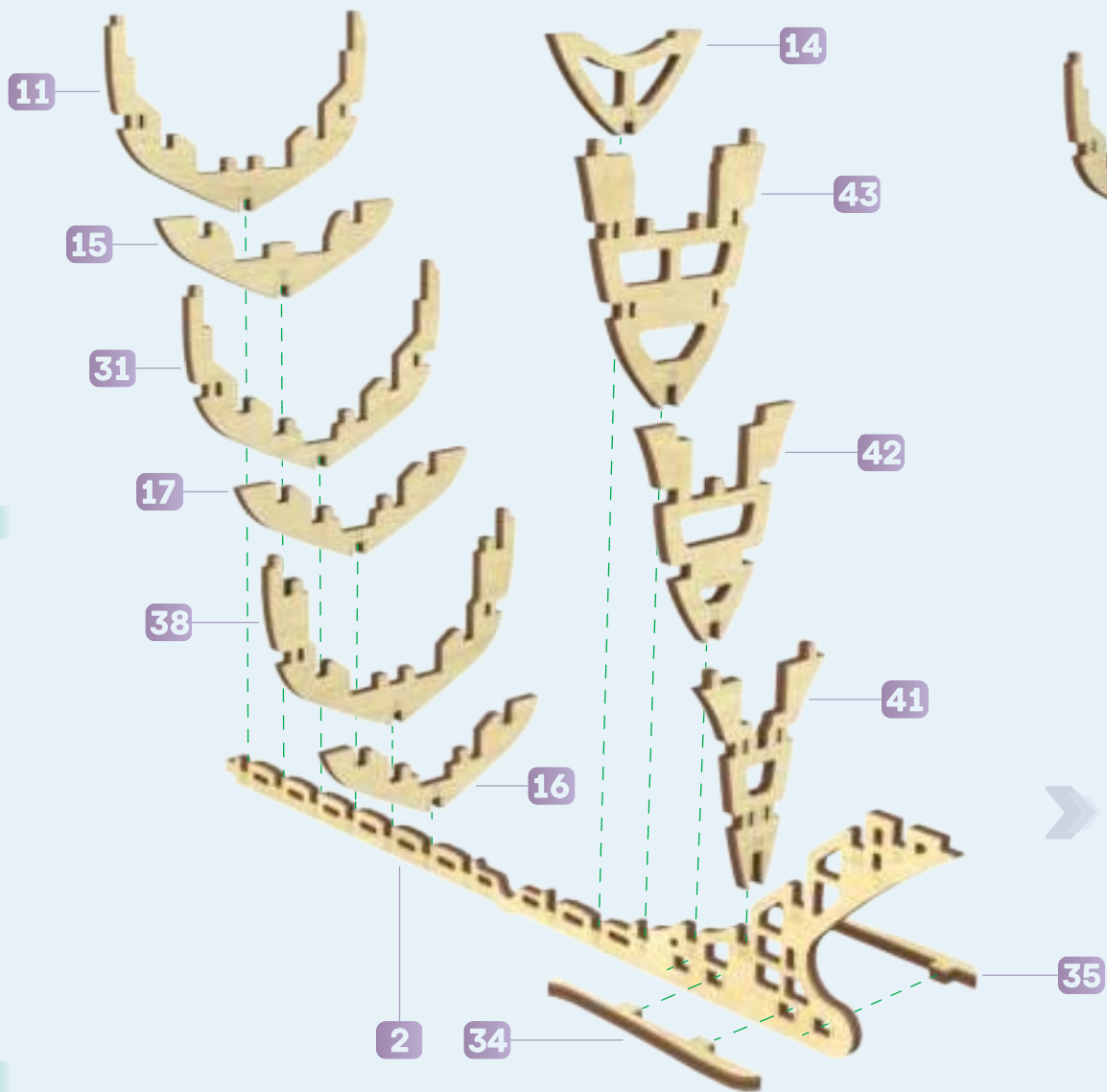



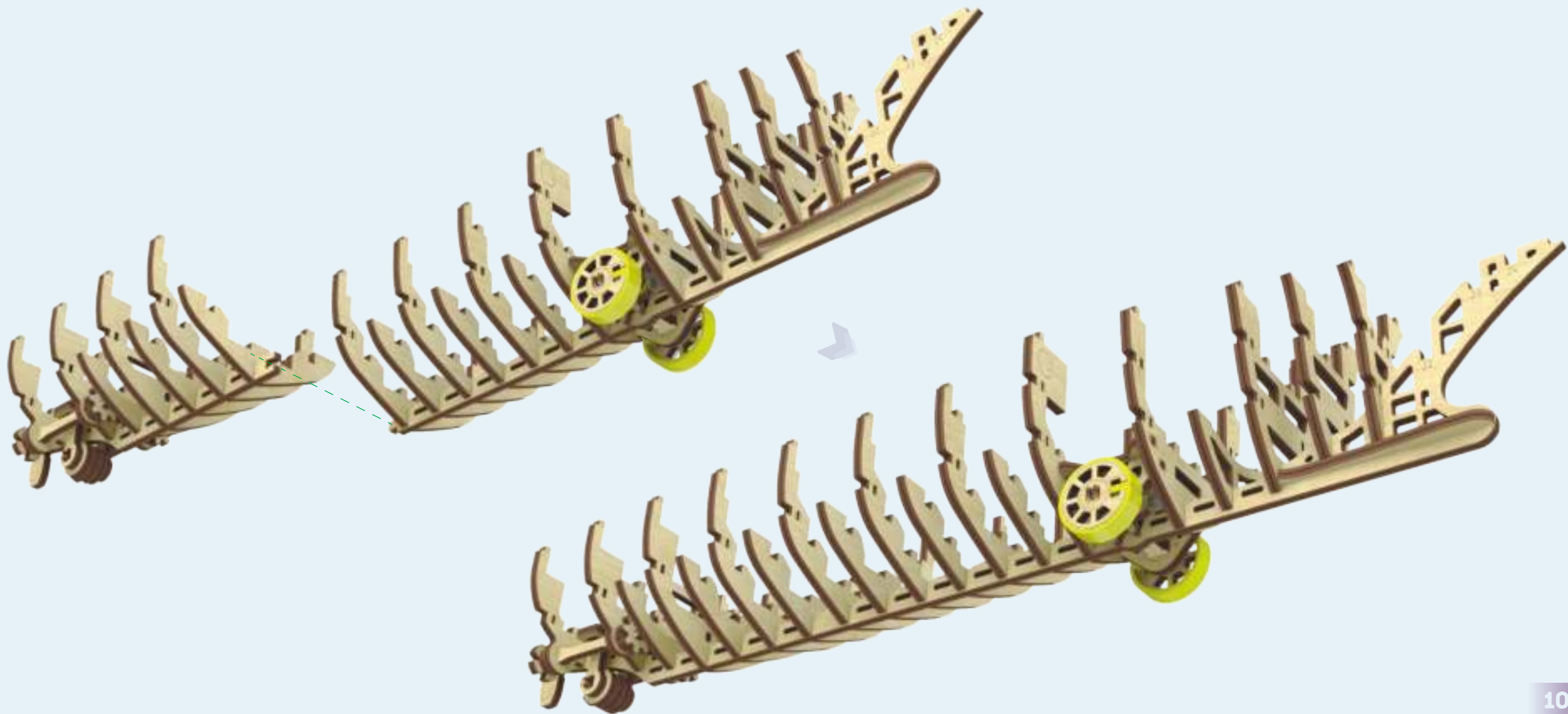

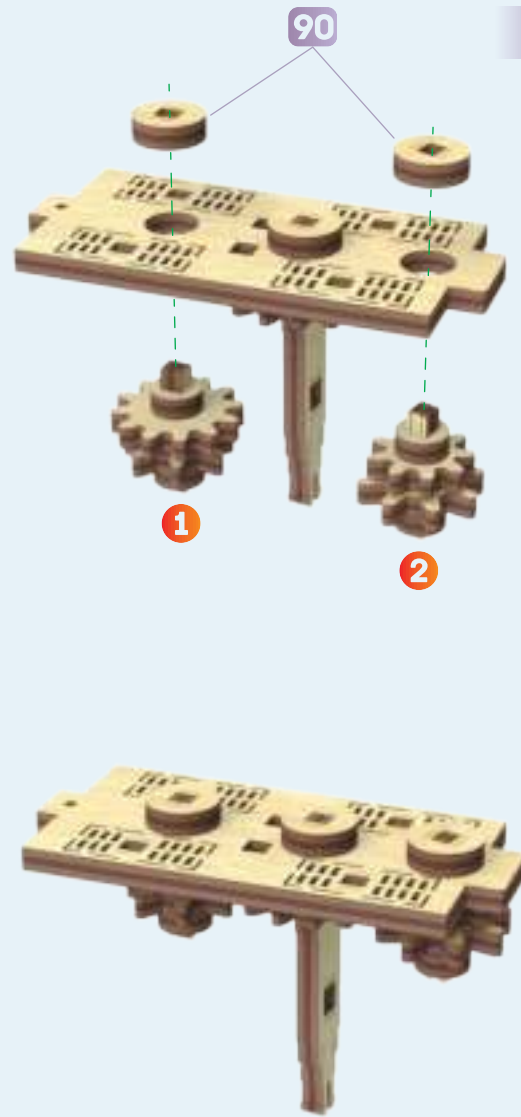
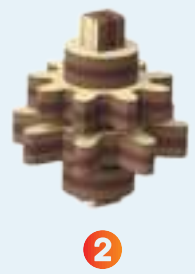
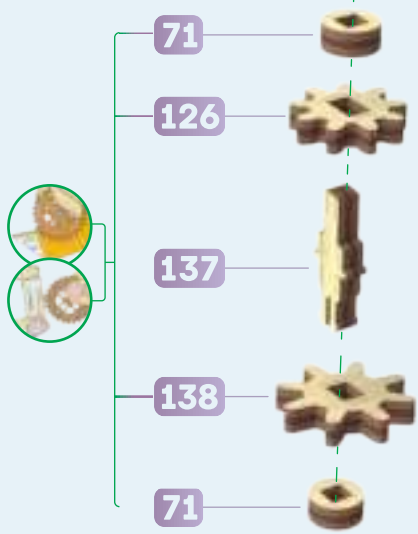
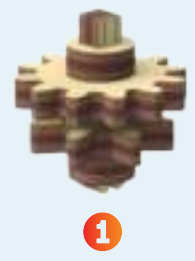
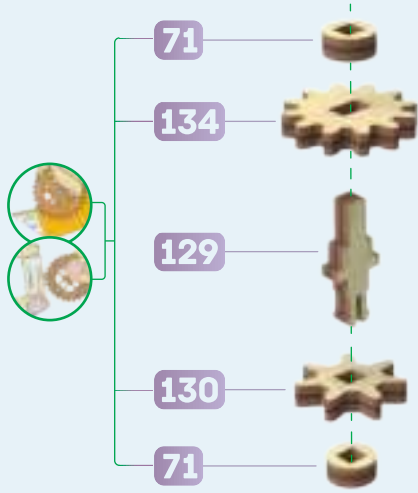
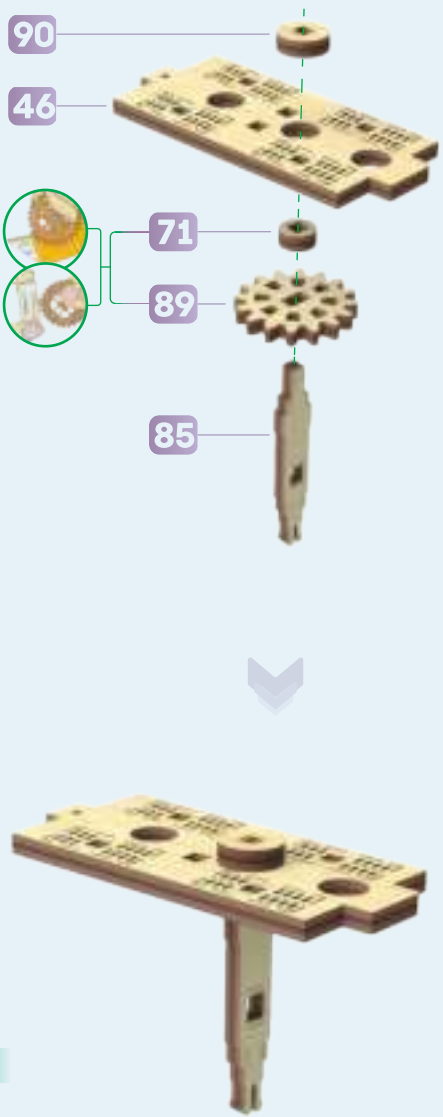
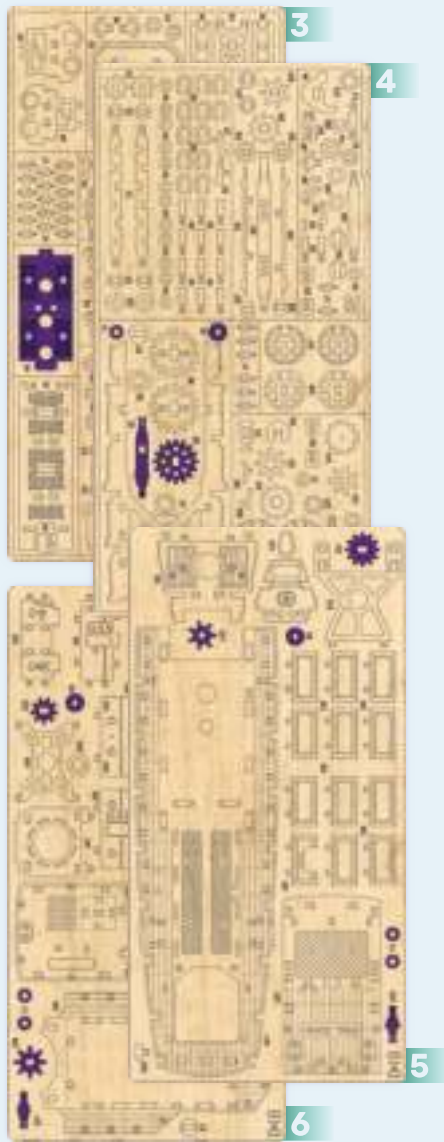



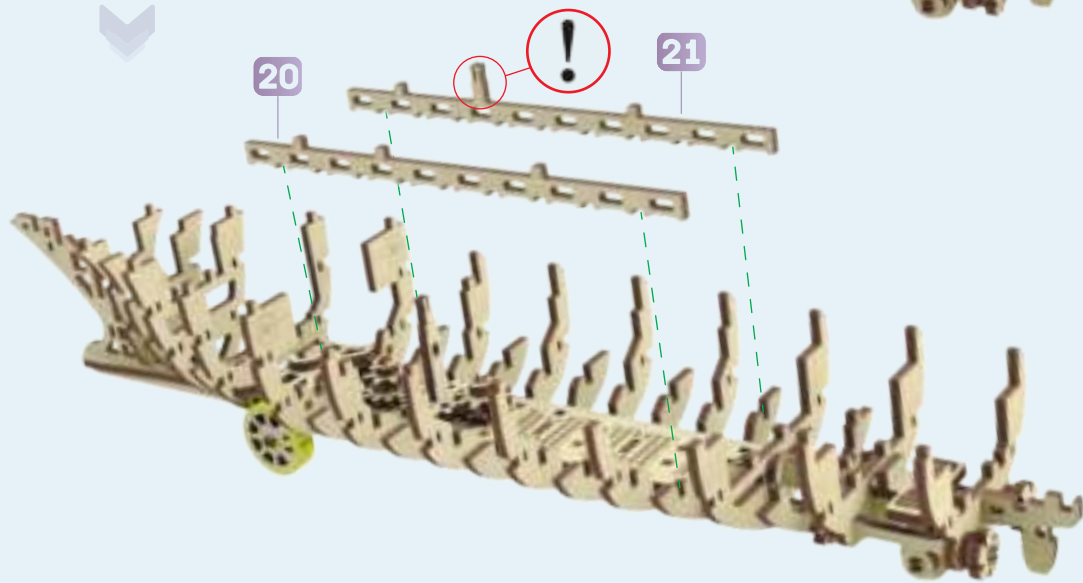
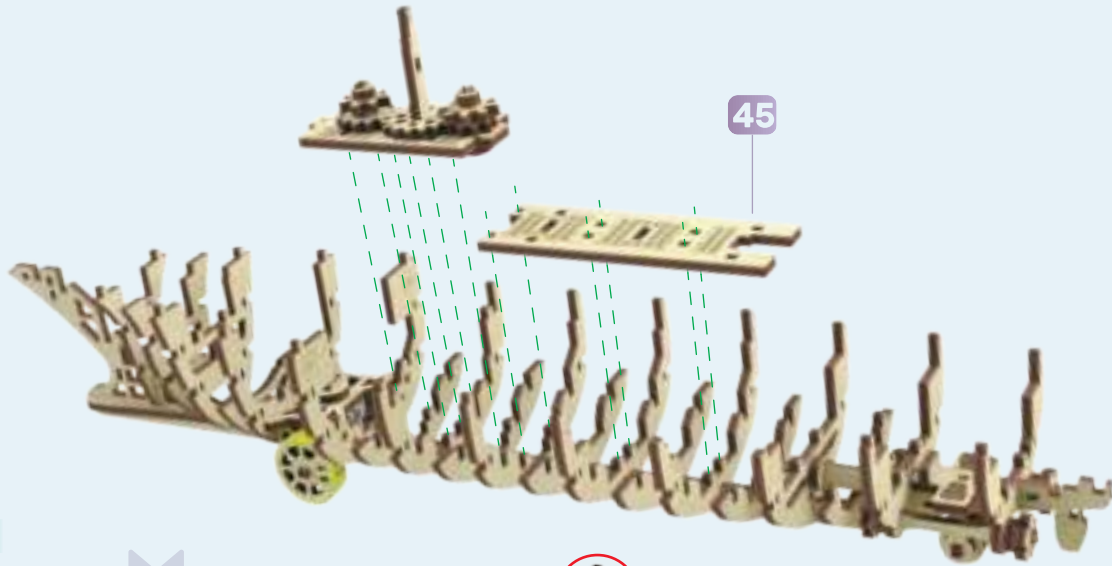

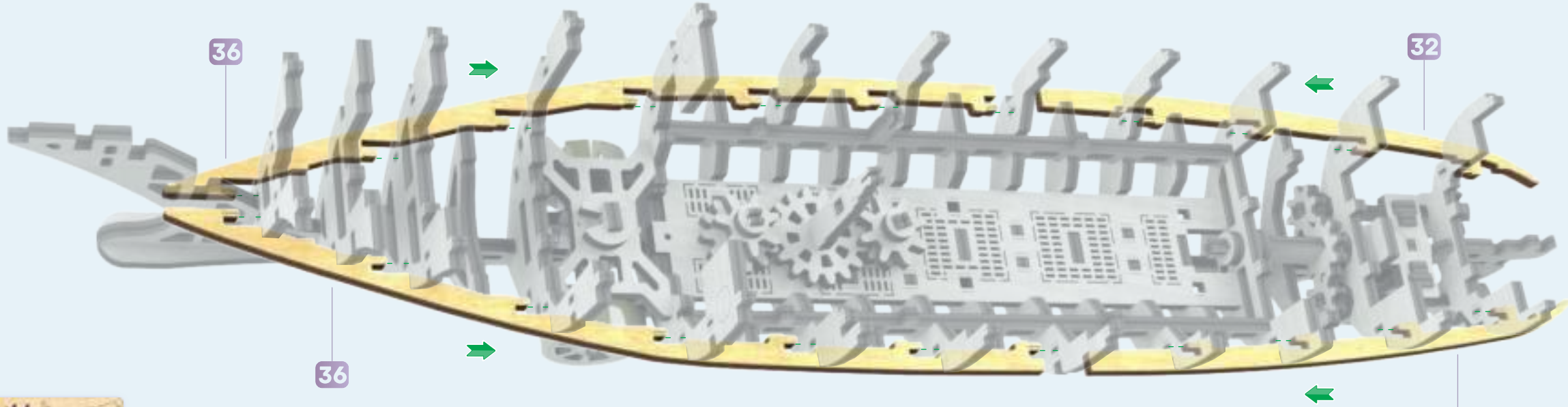

2

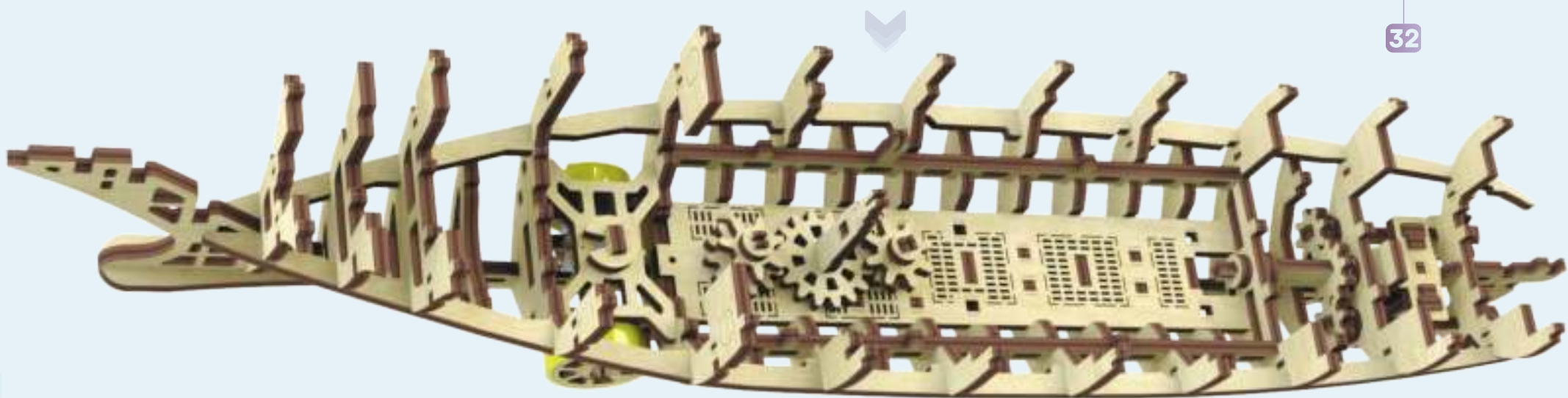



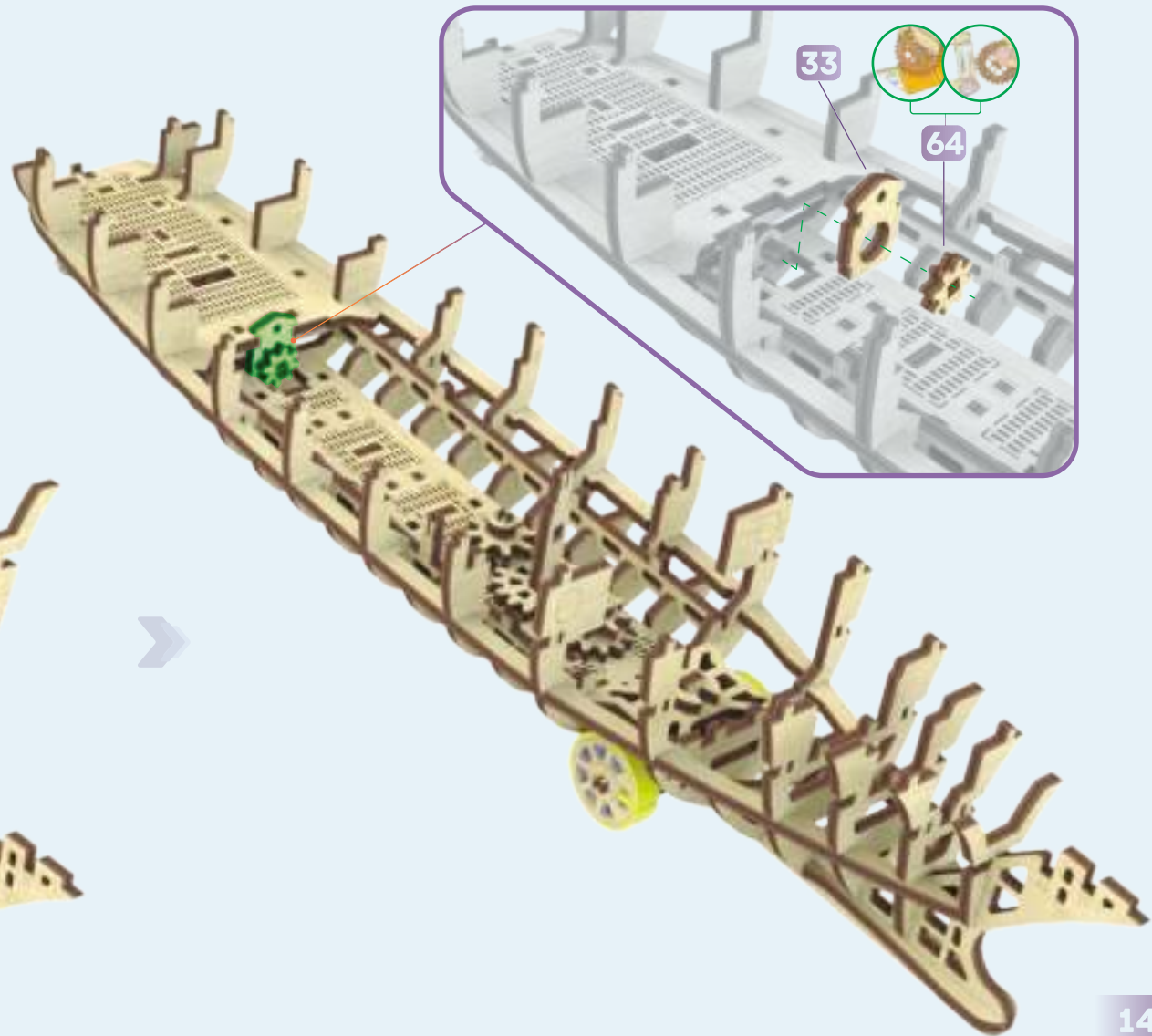
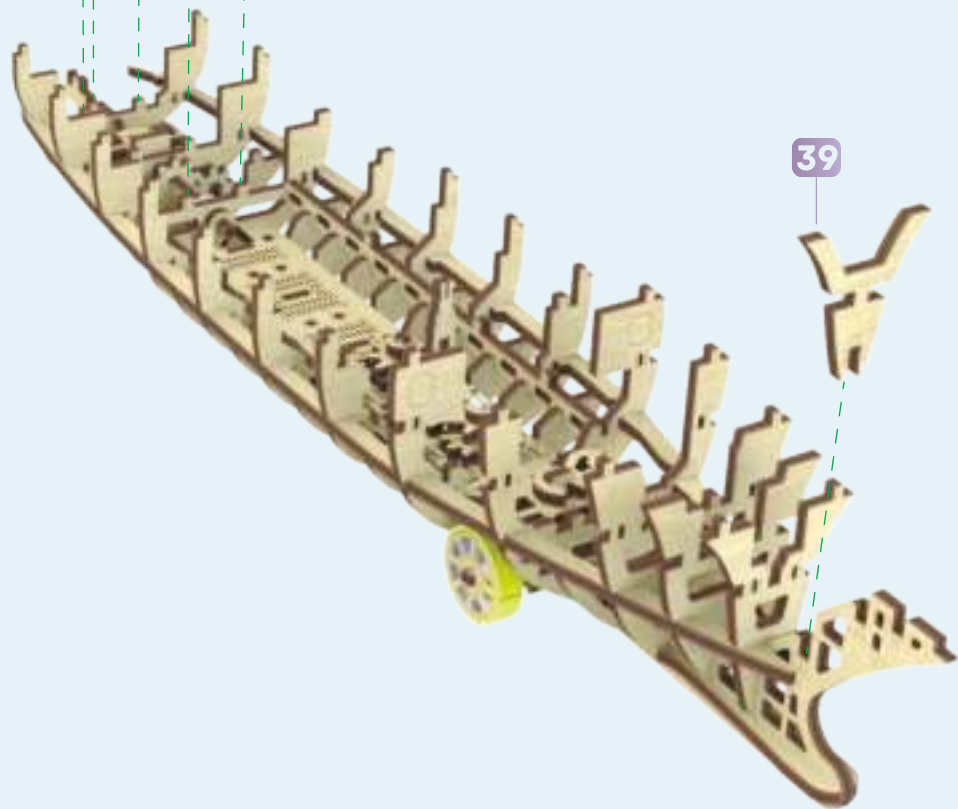
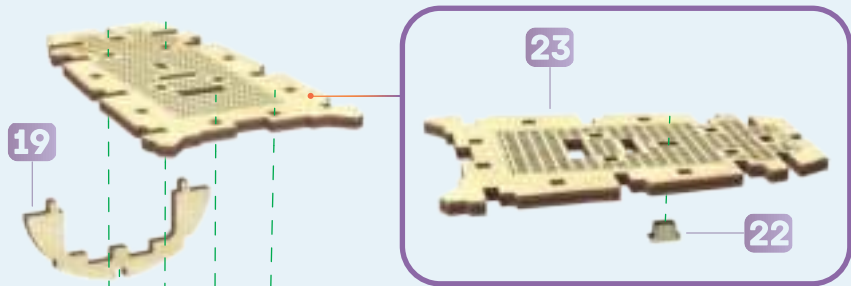
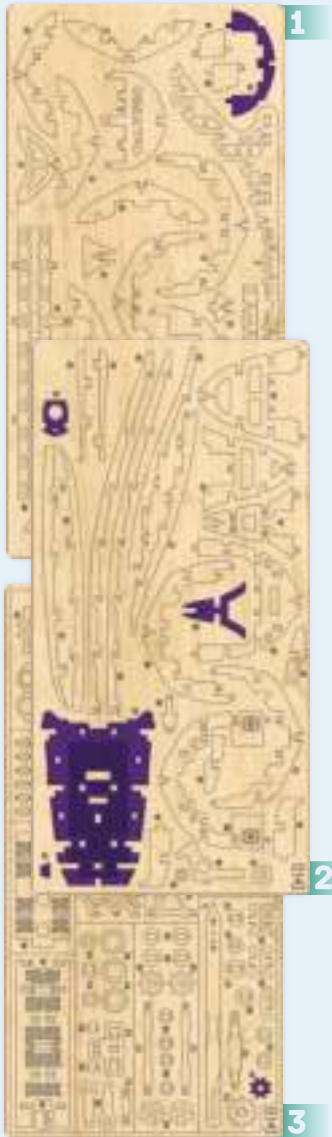



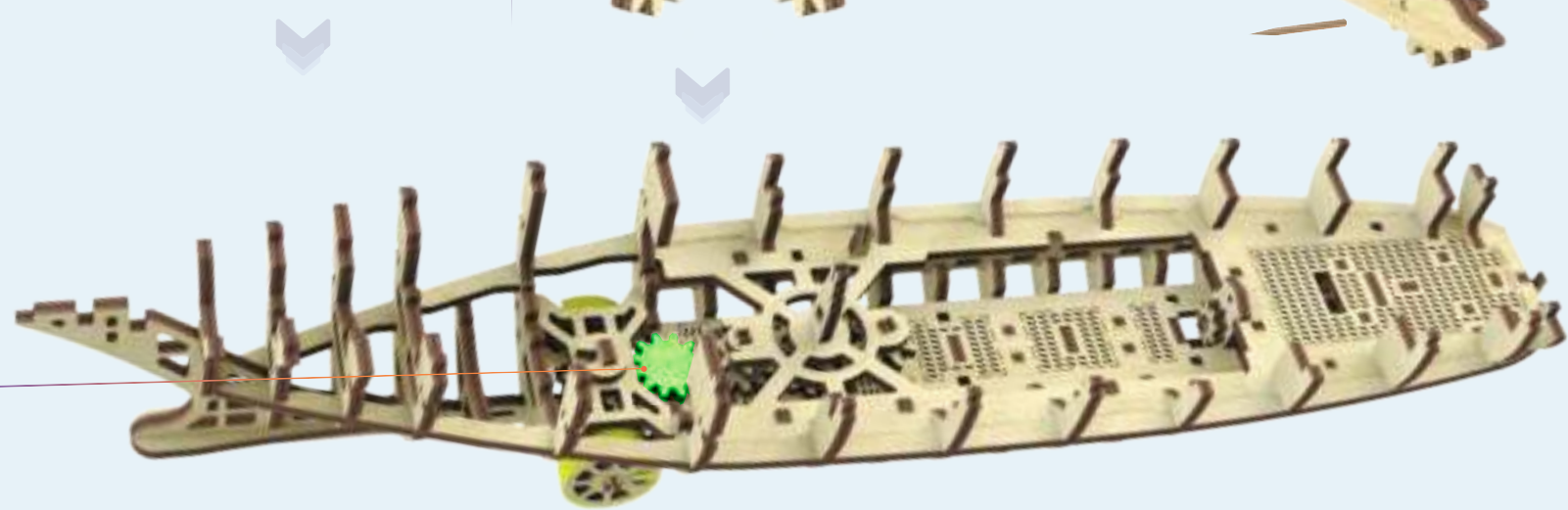
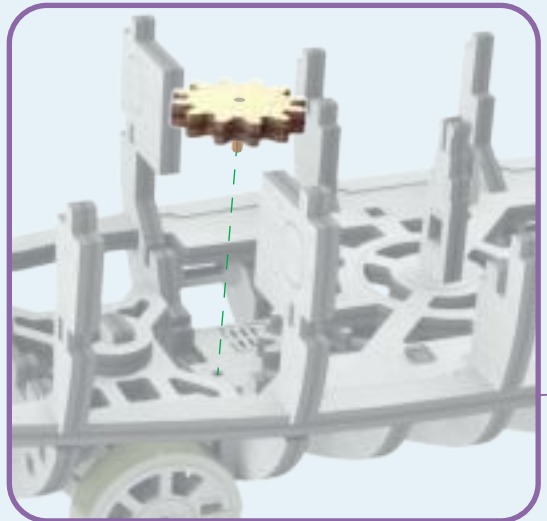
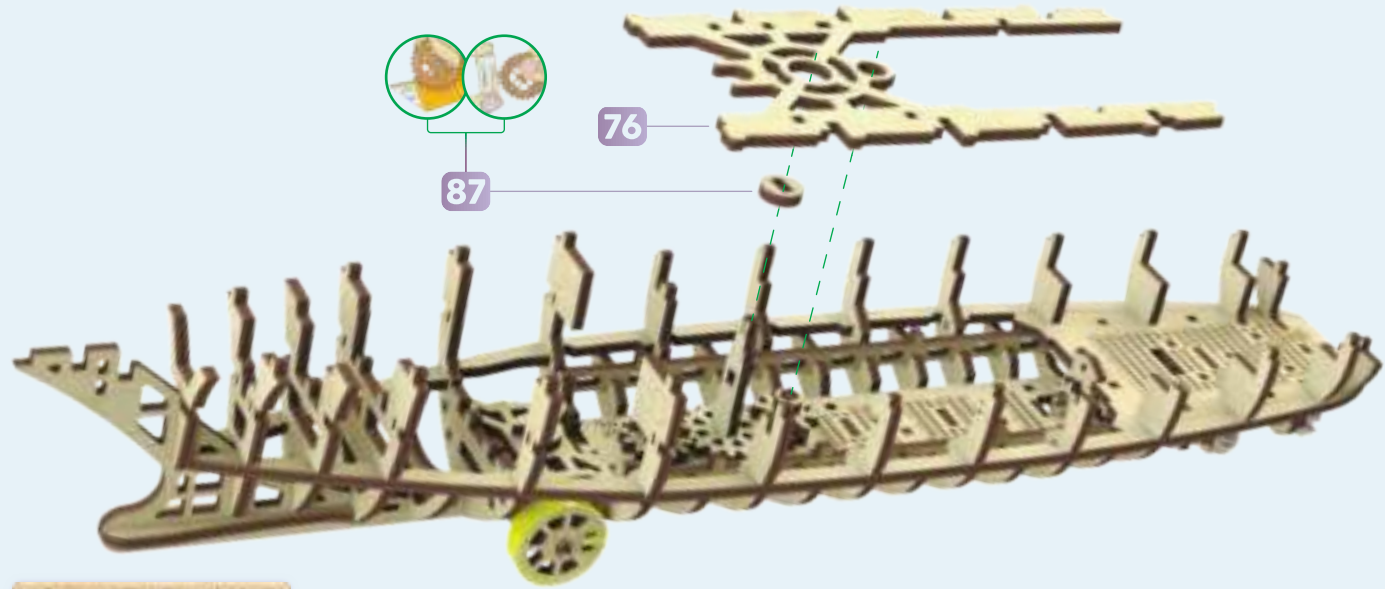

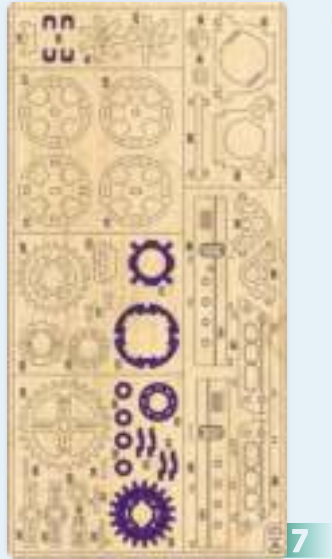
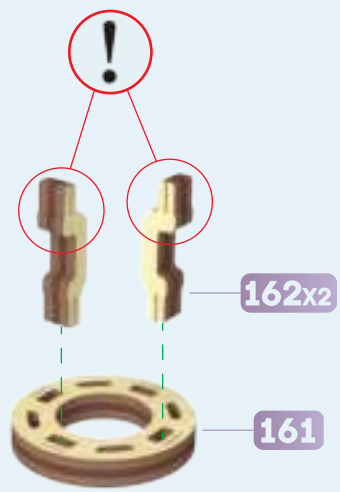
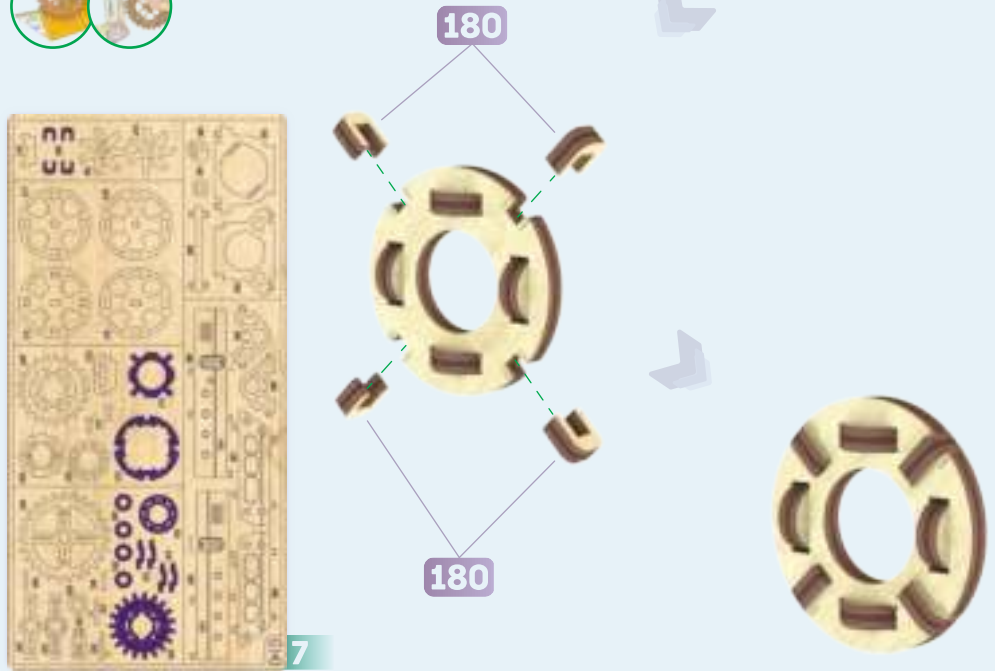

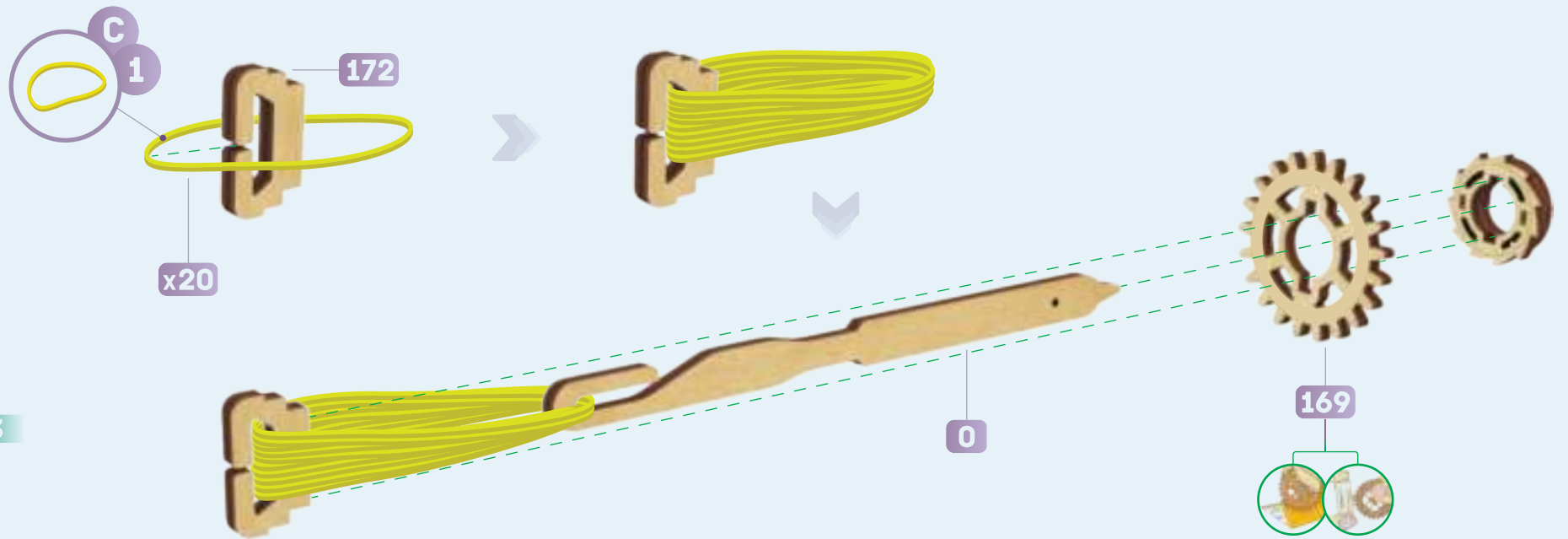
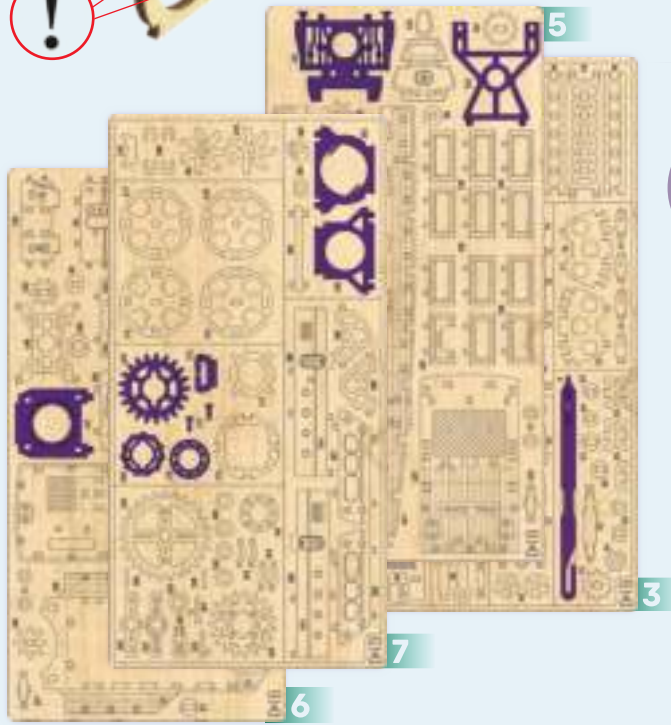
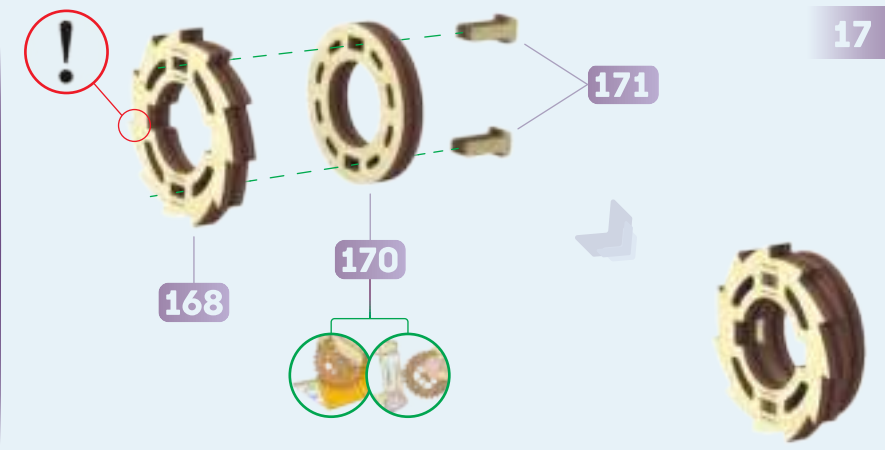



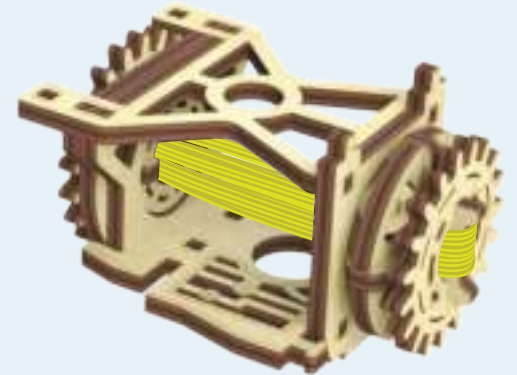
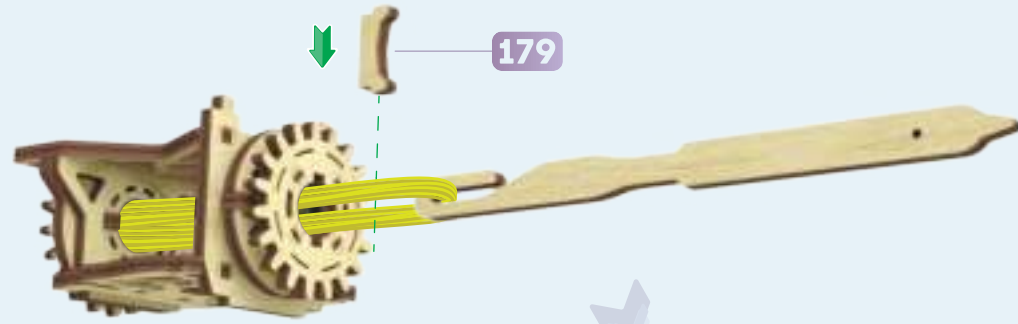
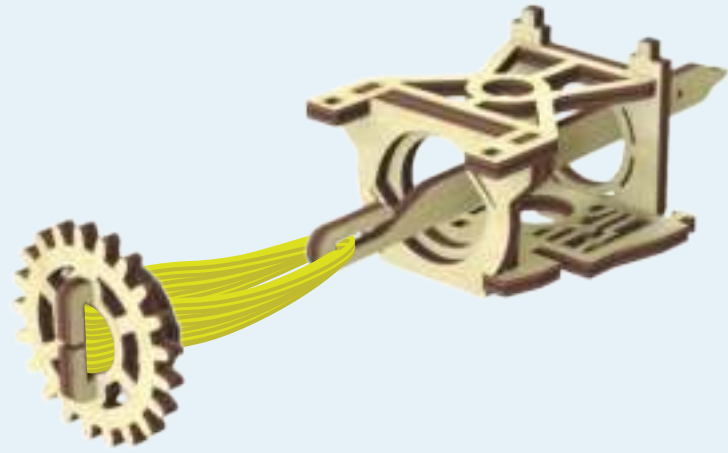

166 164 167



157

156

158x2

159

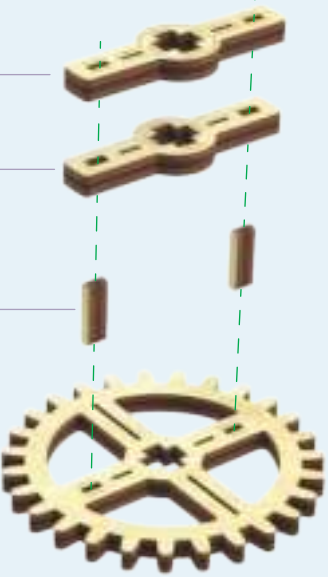

165

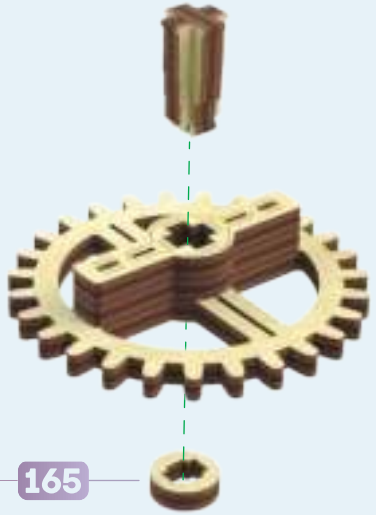

182

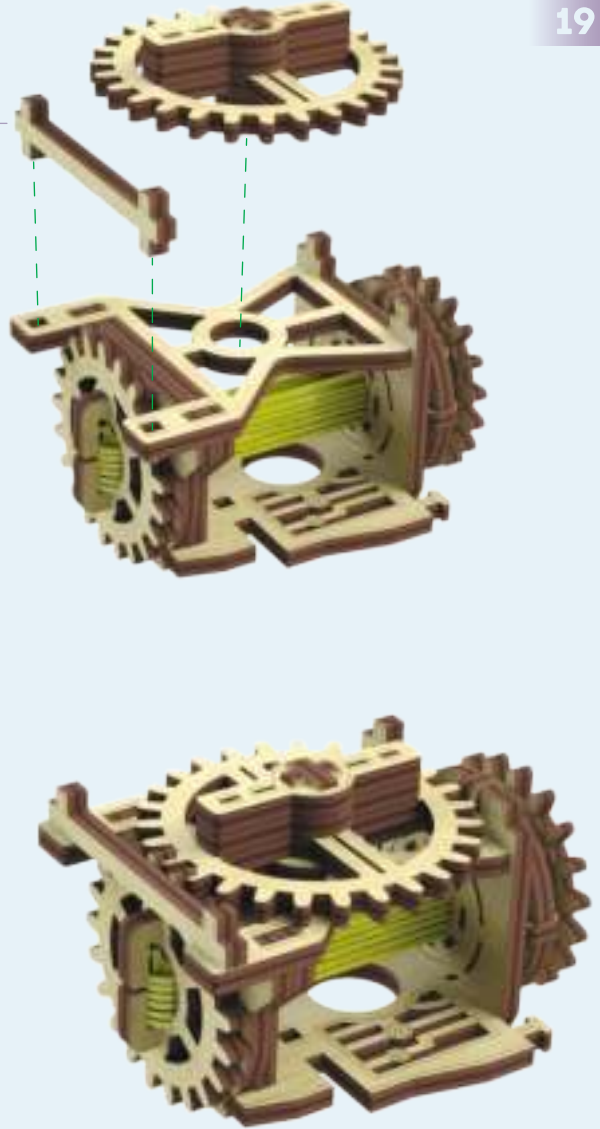

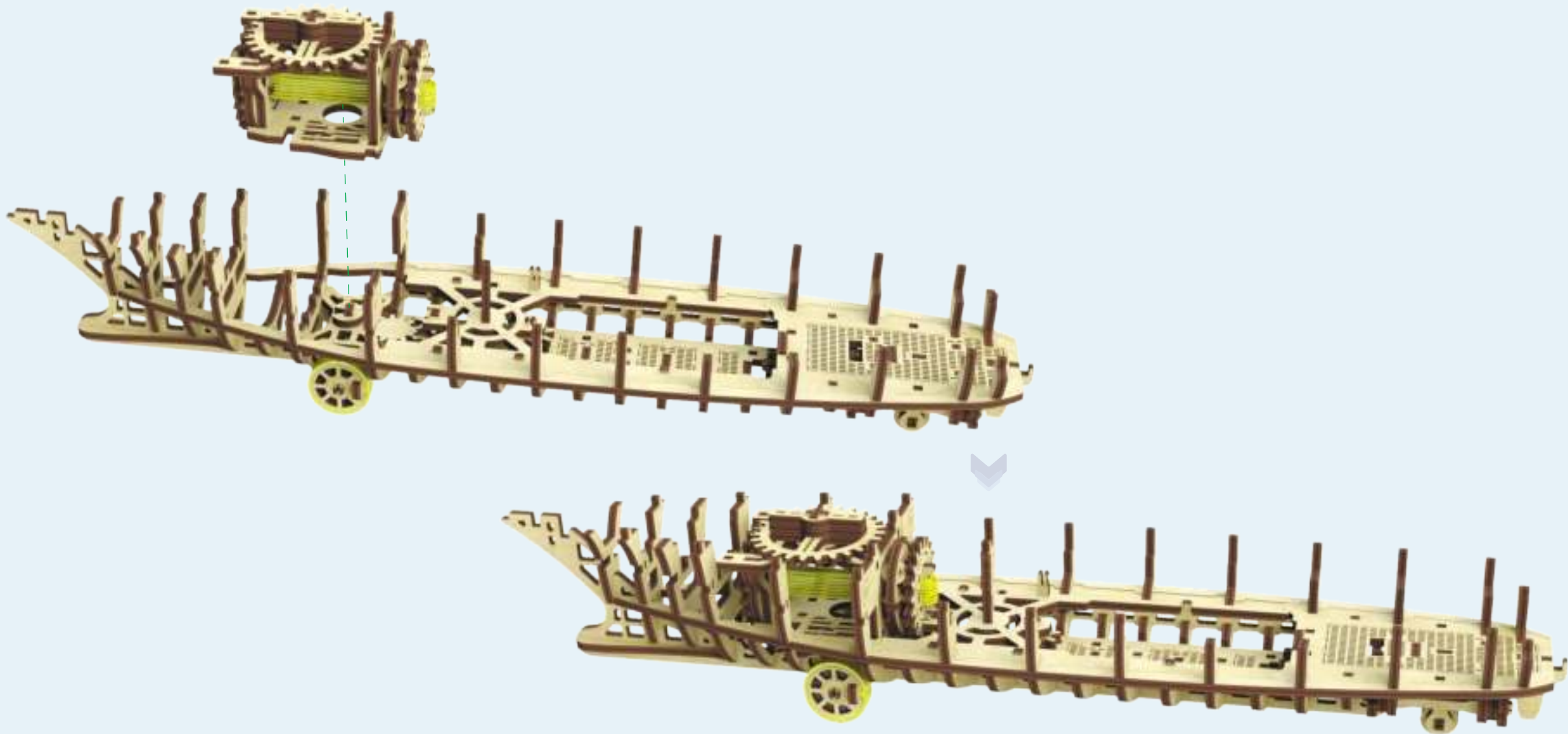



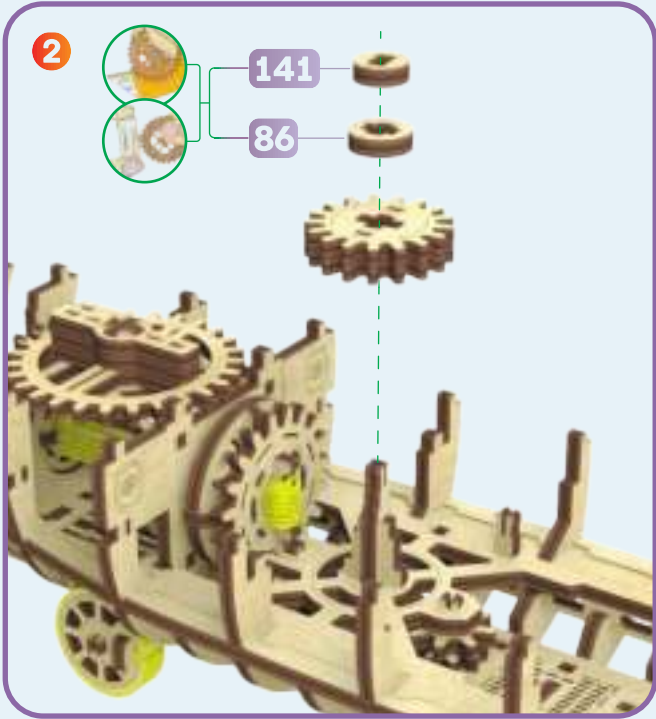
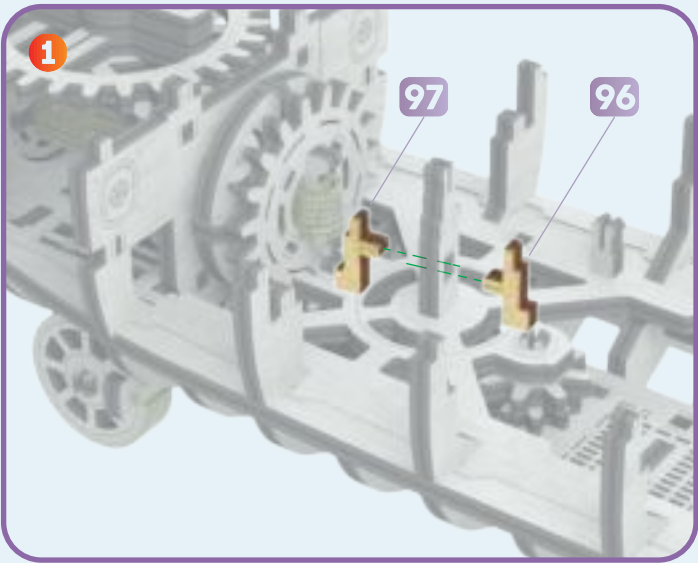
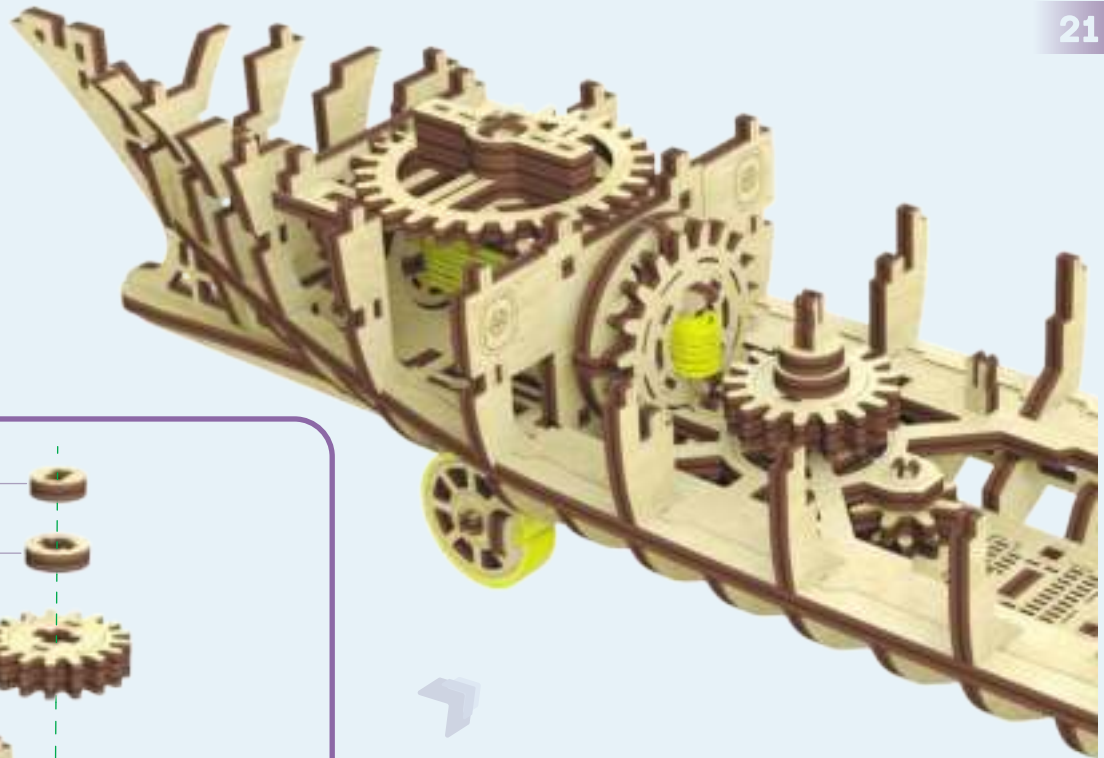
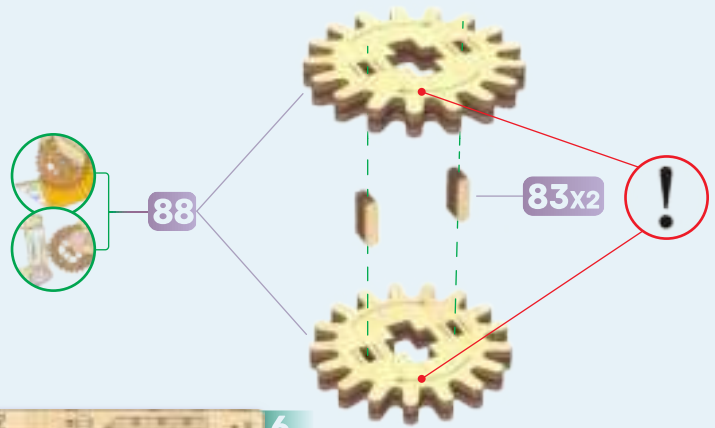

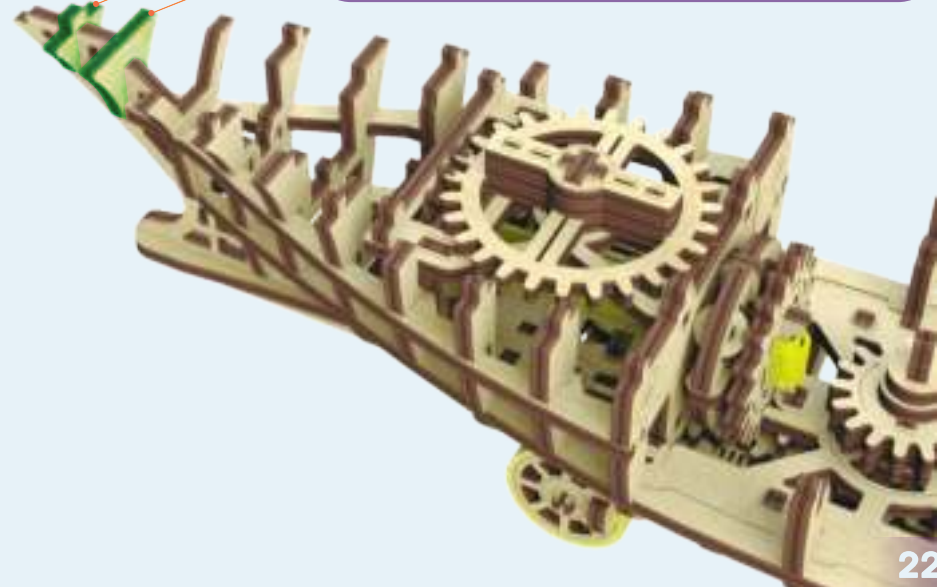
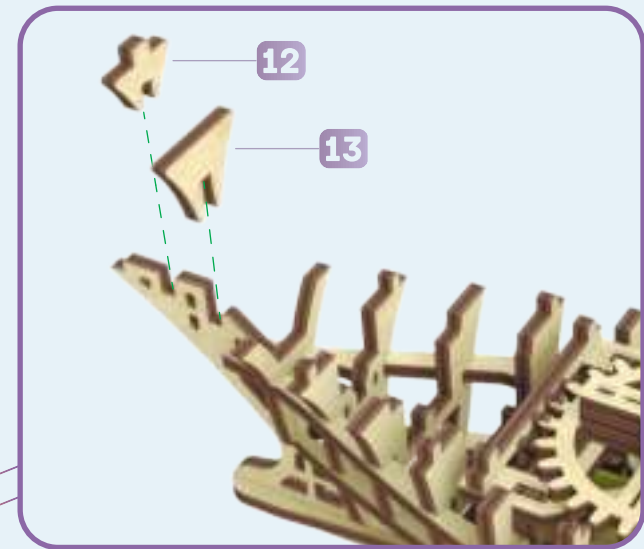
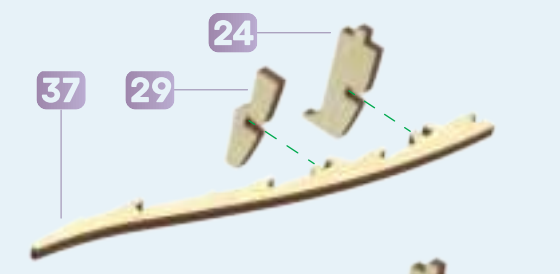
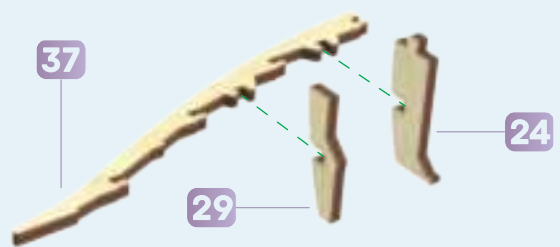

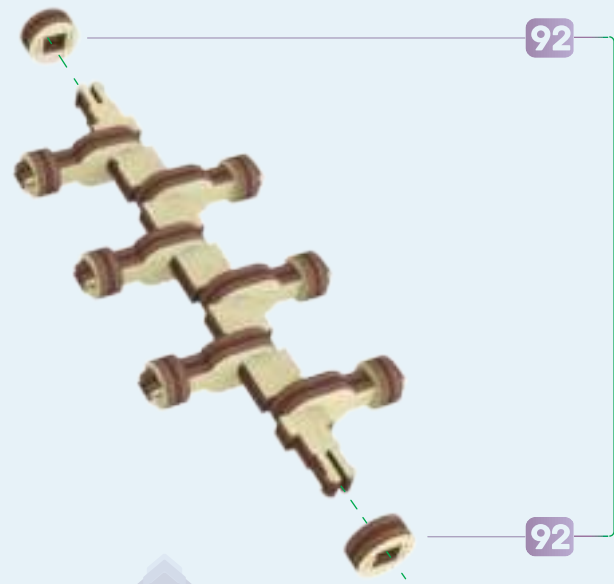
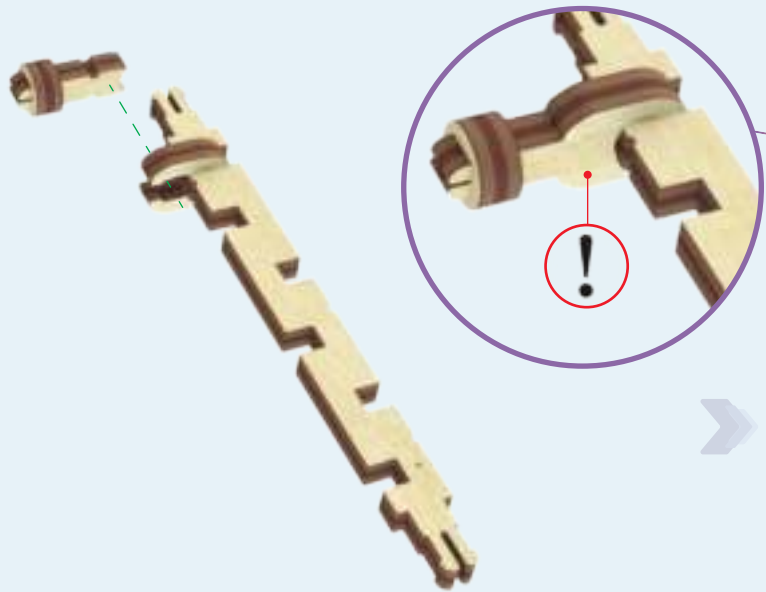



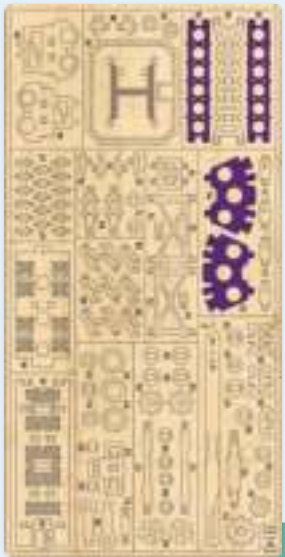

3

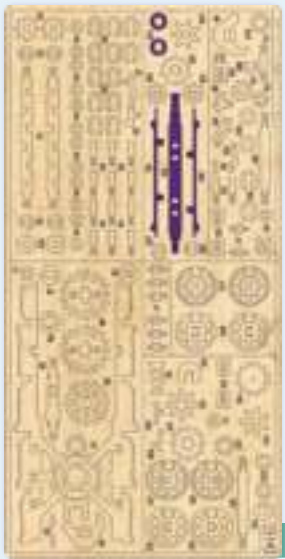

4

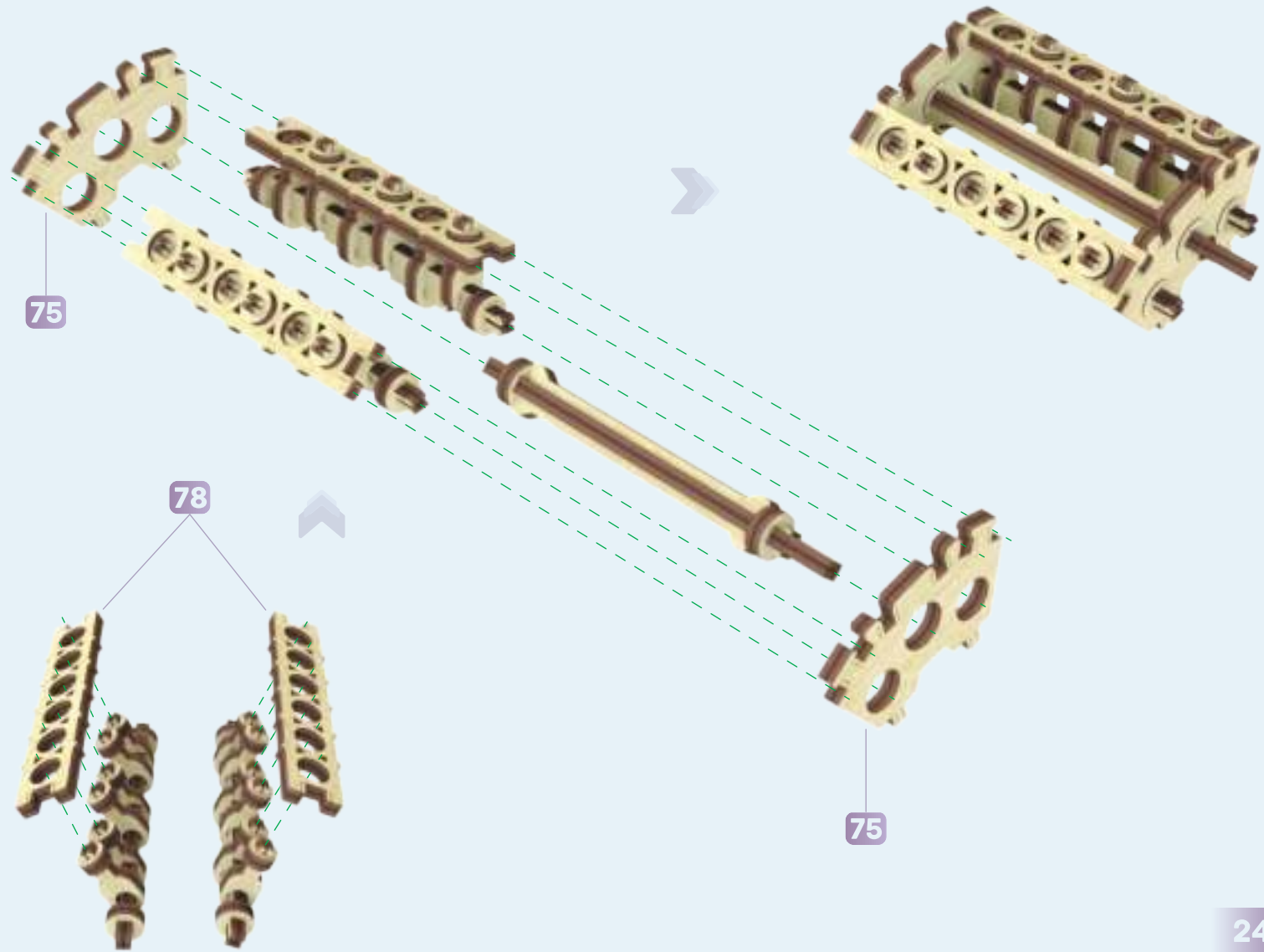

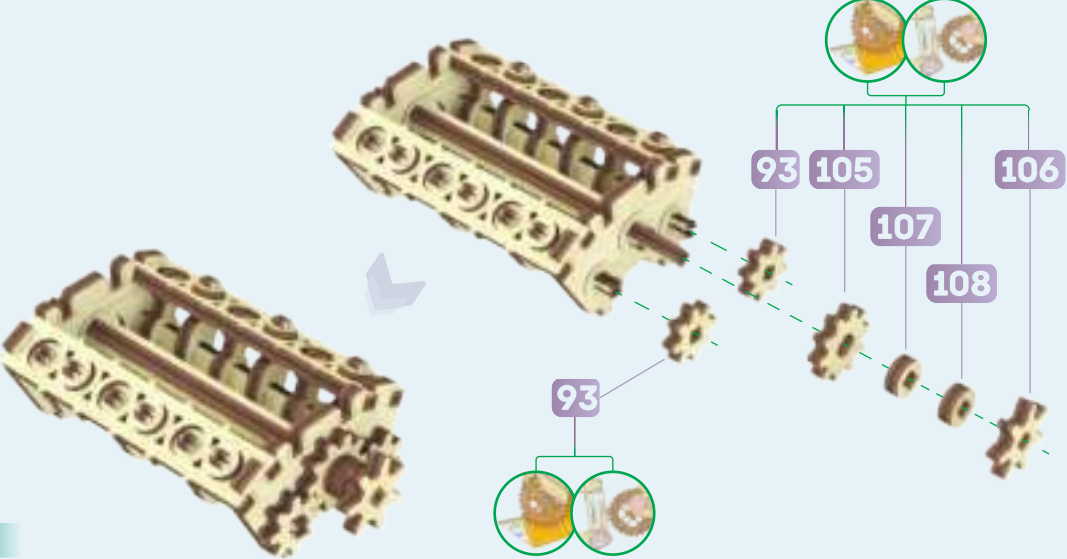
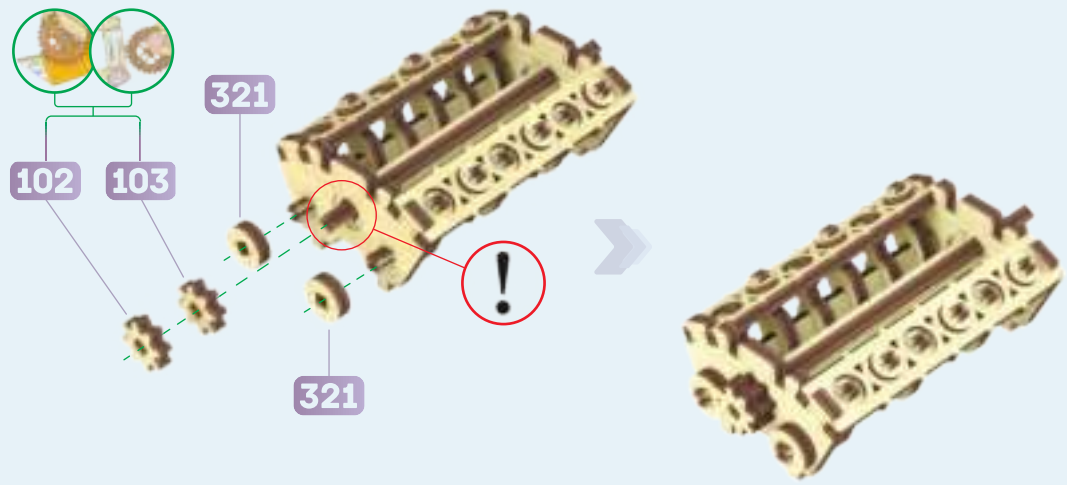
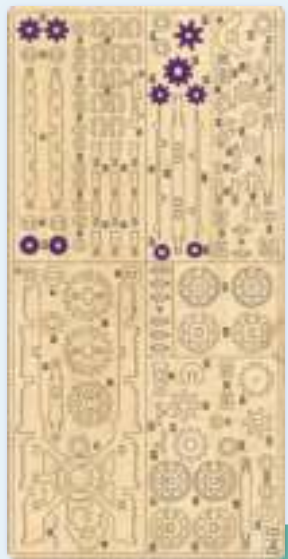



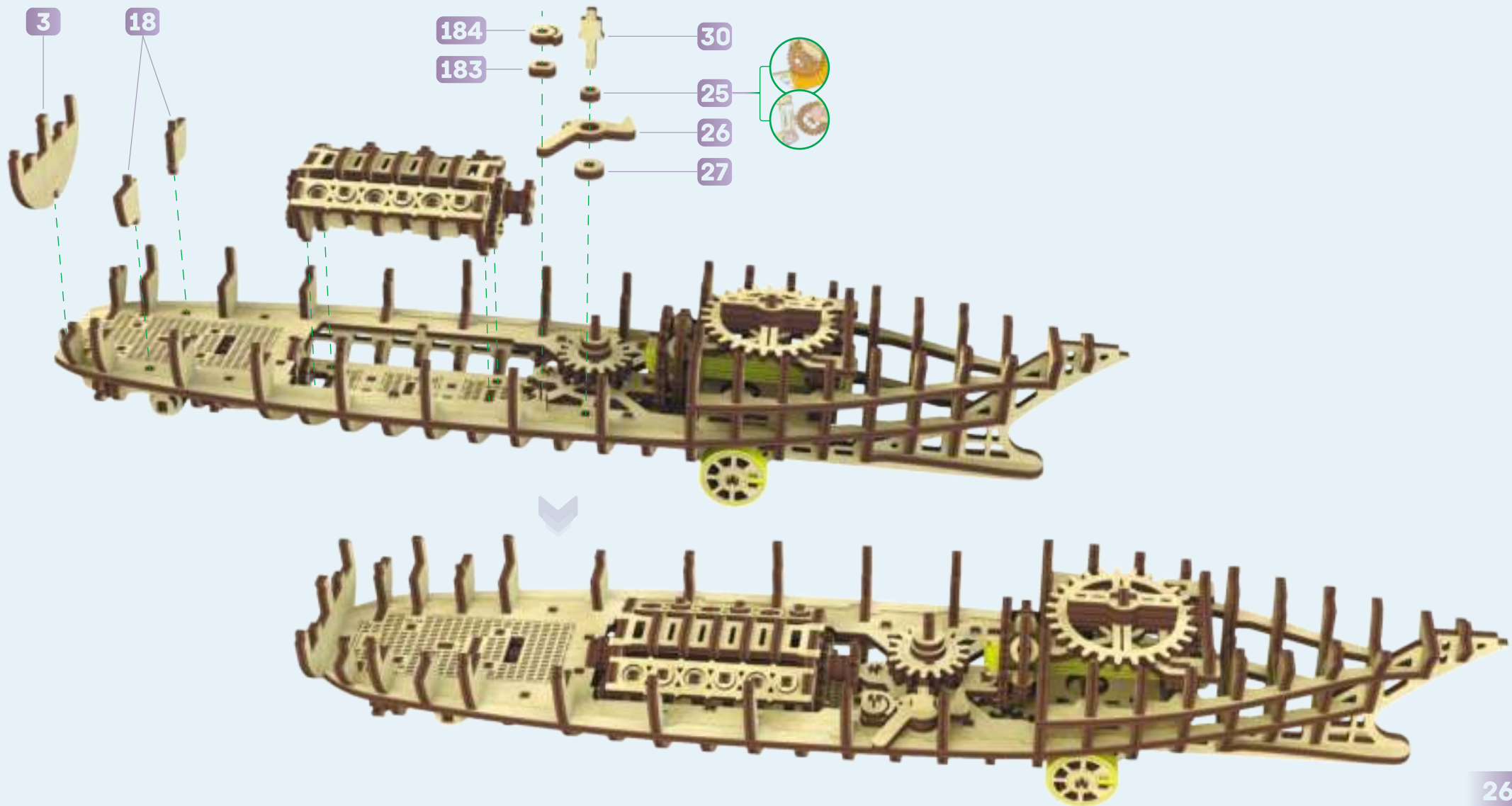



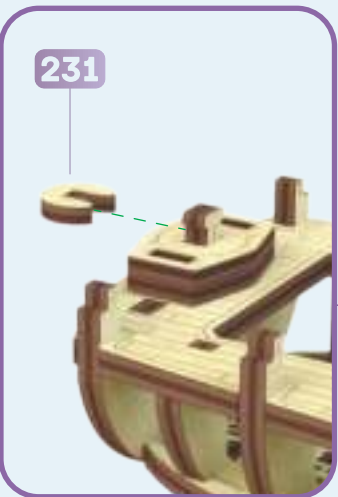
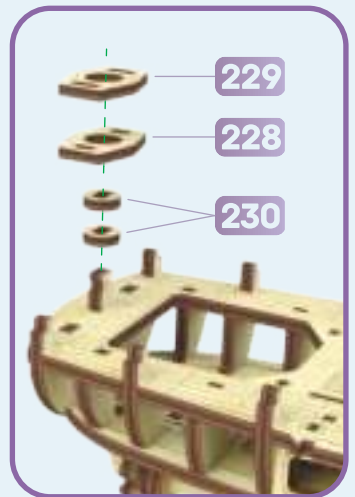
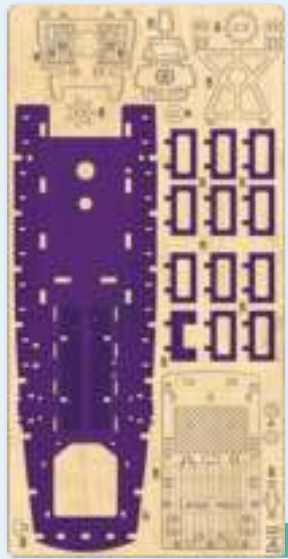
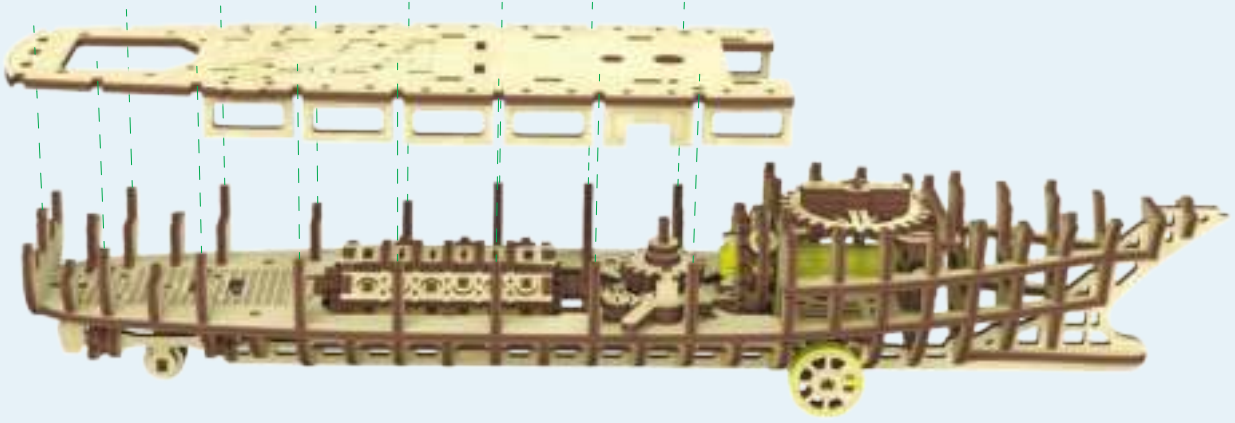
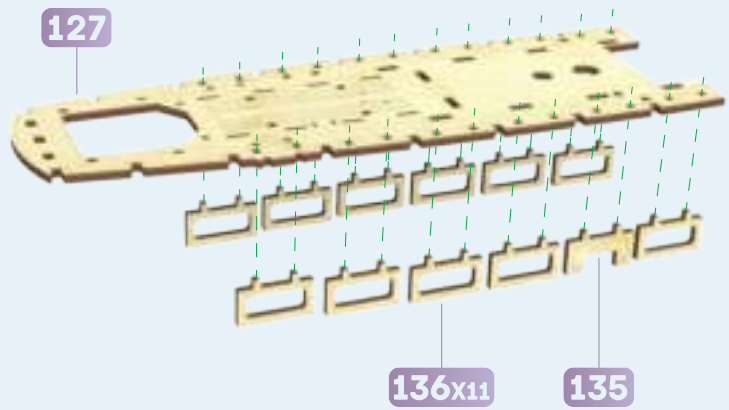

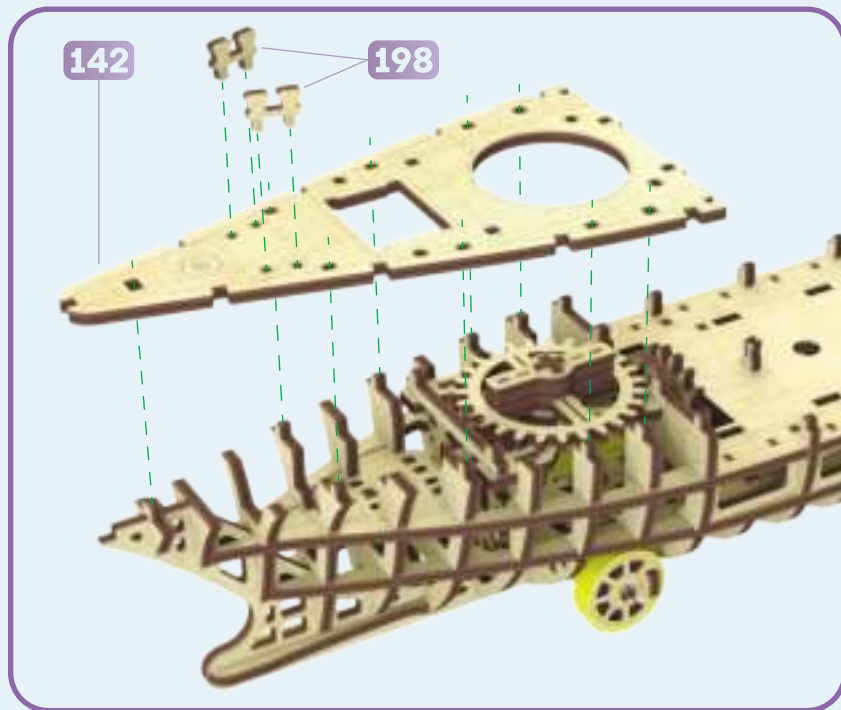
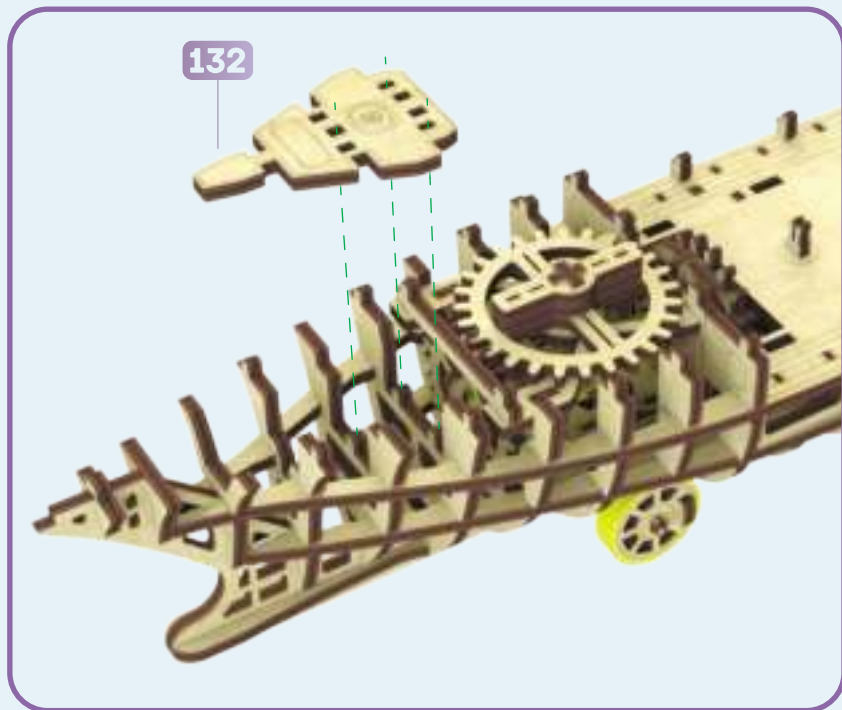
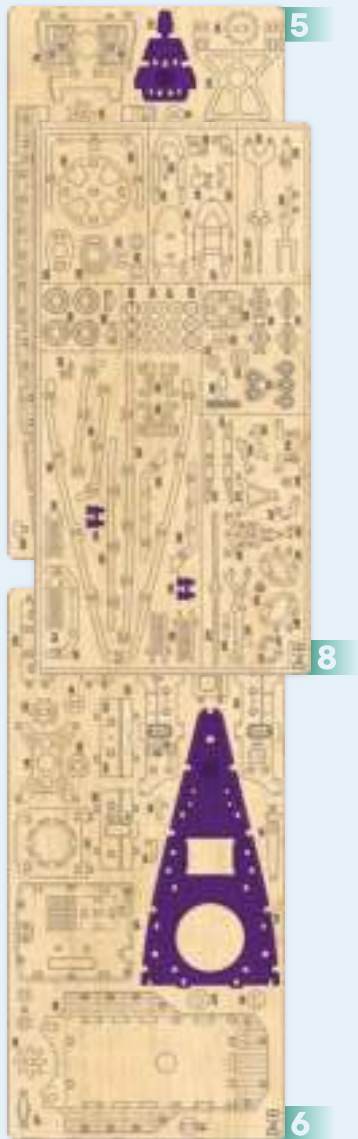





8

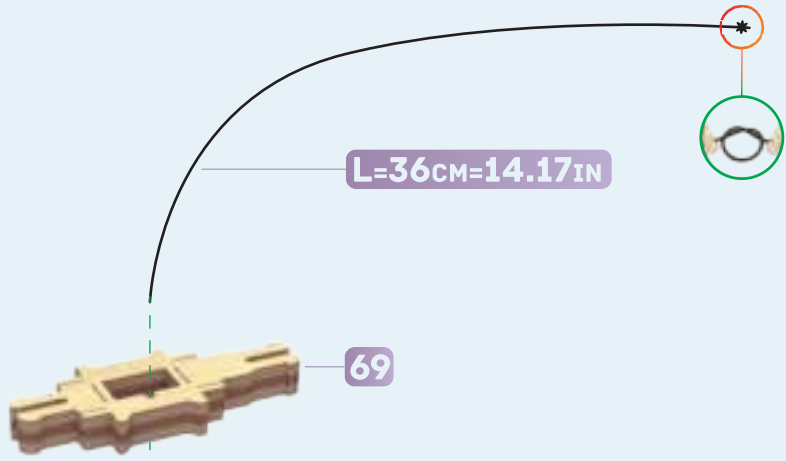

L=36CM=14.17IN

69



3



70

x2

70

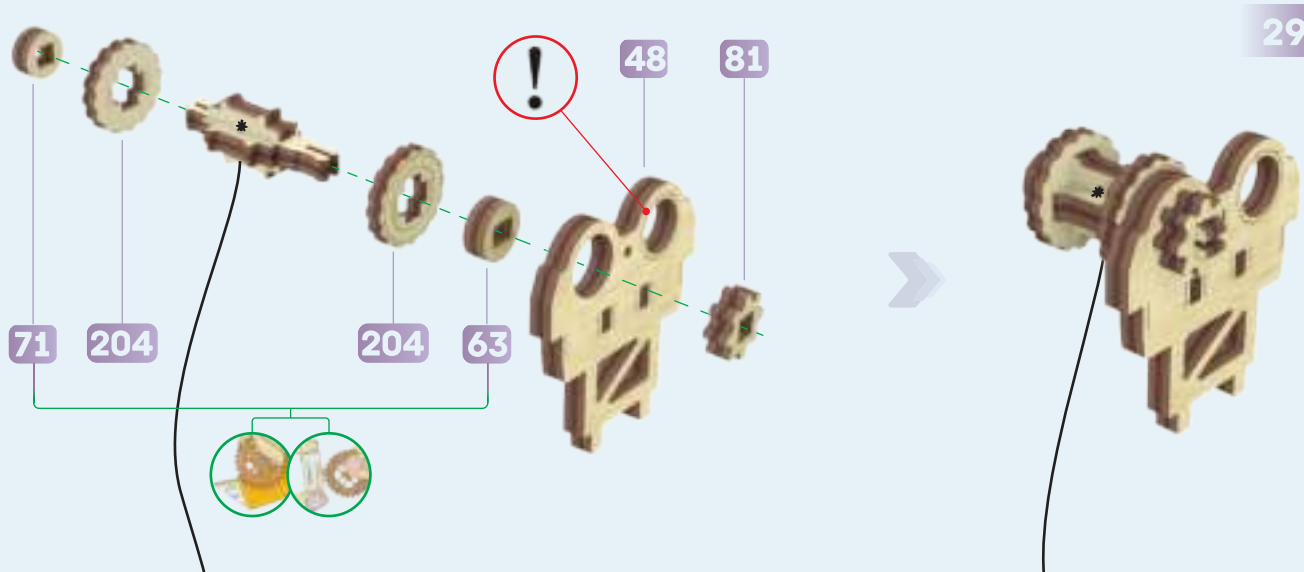

29

71

204

204

63

48

81

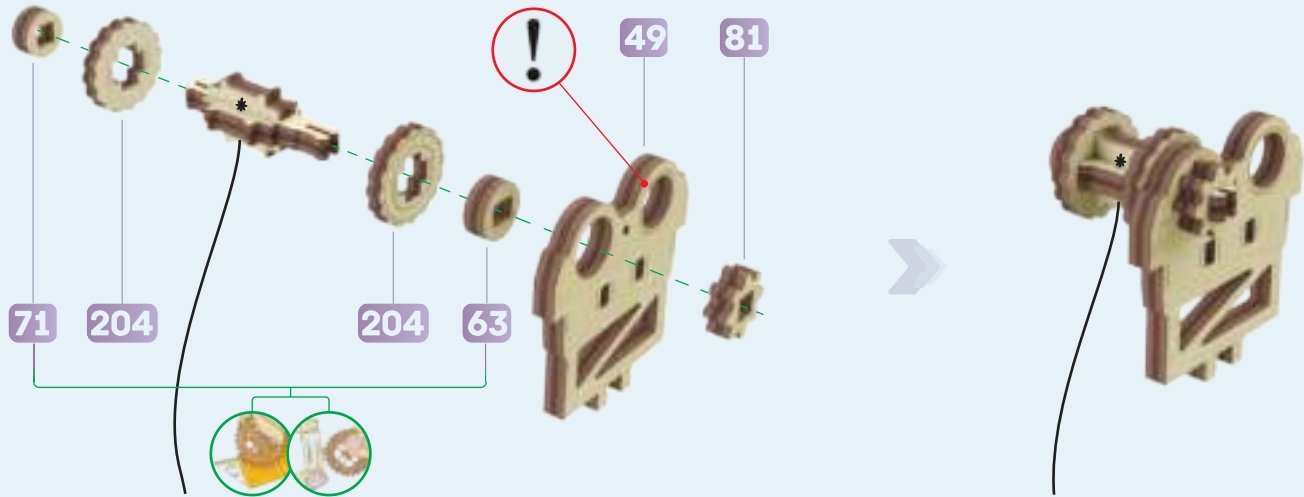

71

204

204

63

49

81





8

3

74

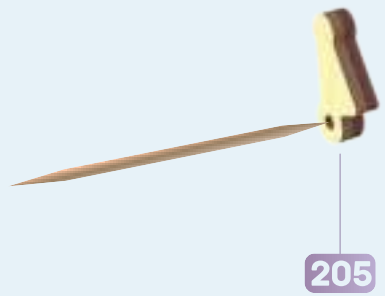
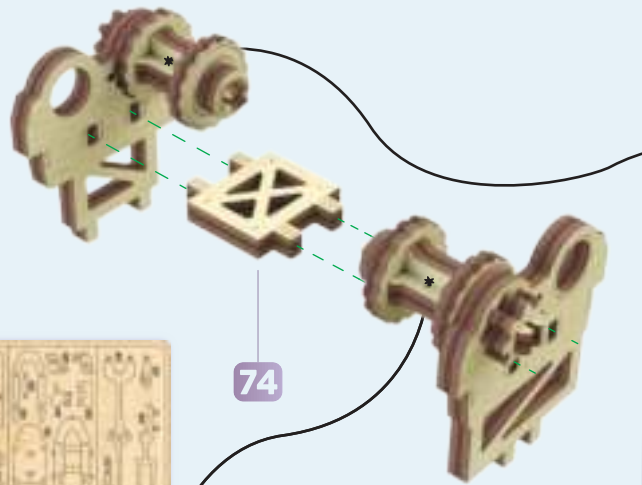

205



x2

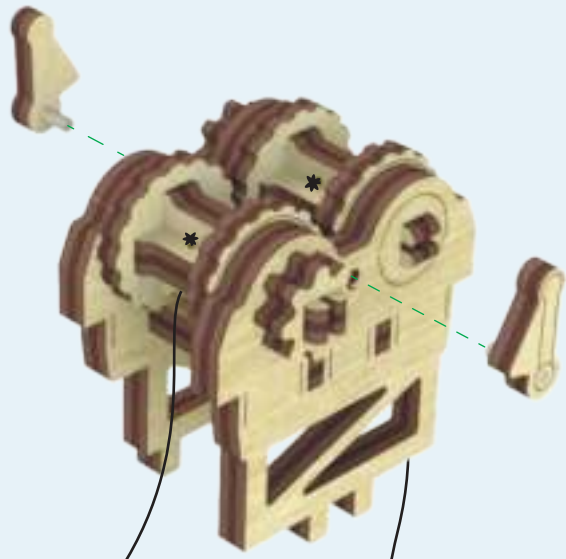

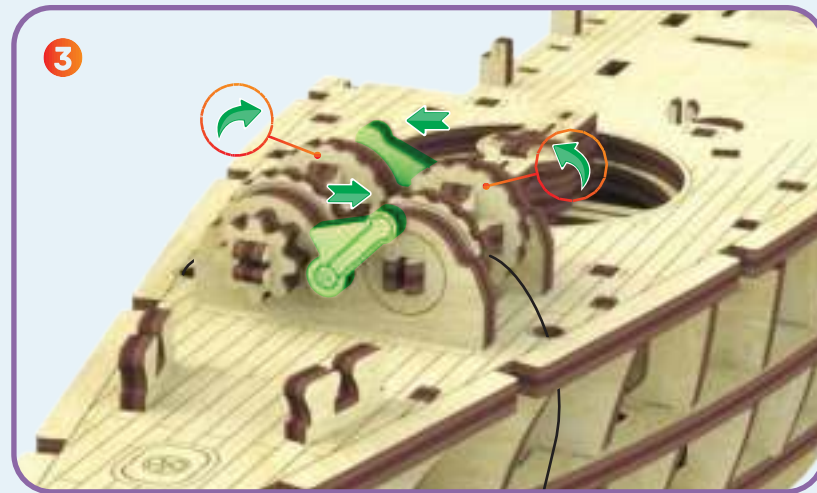
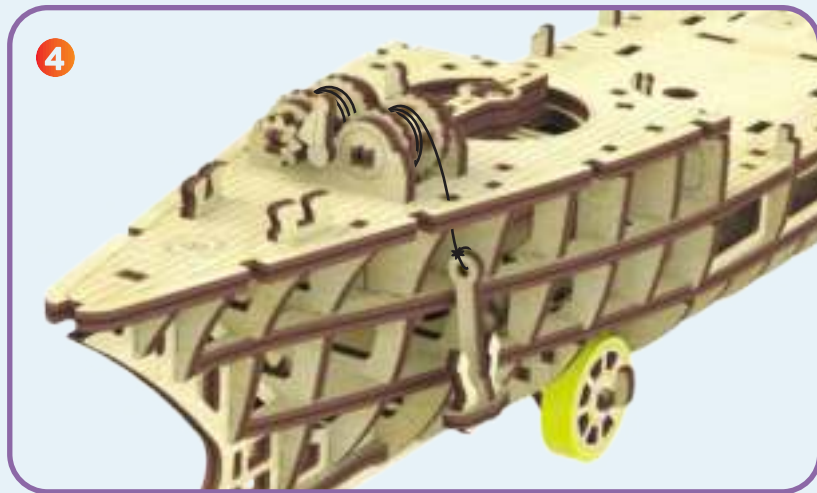
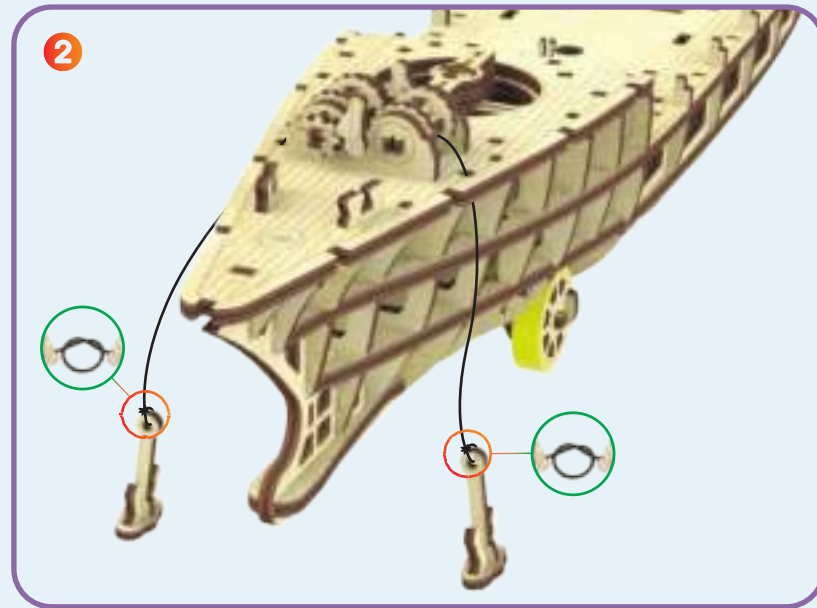
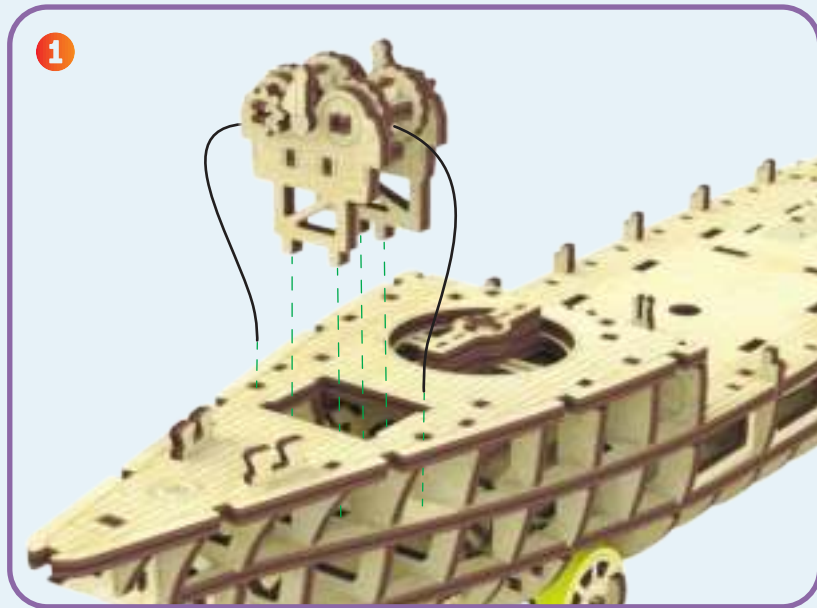
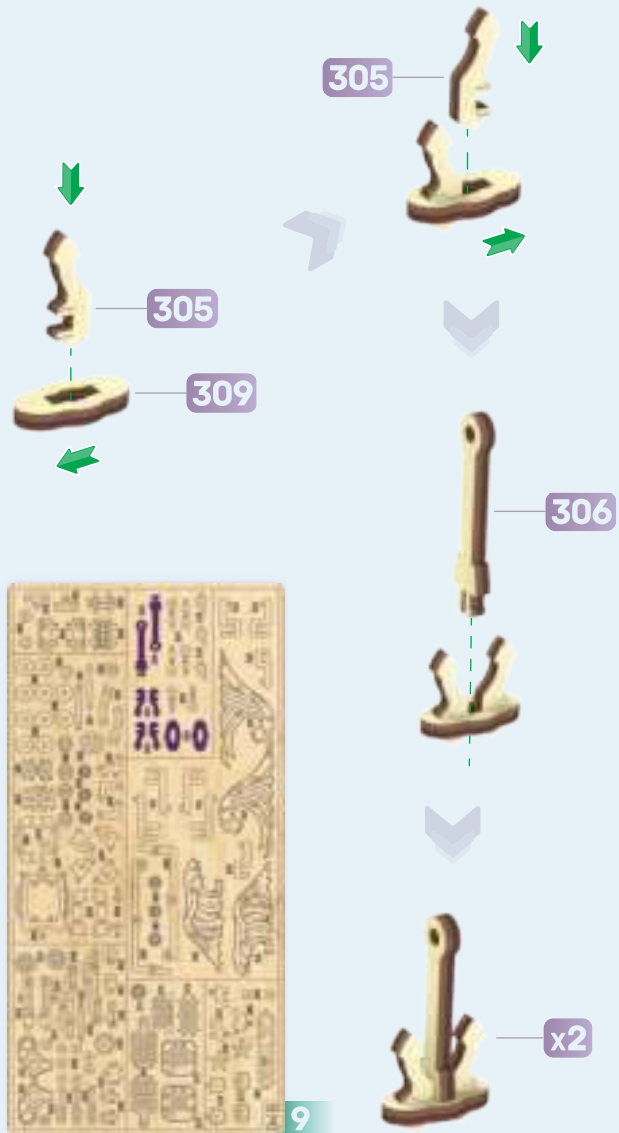

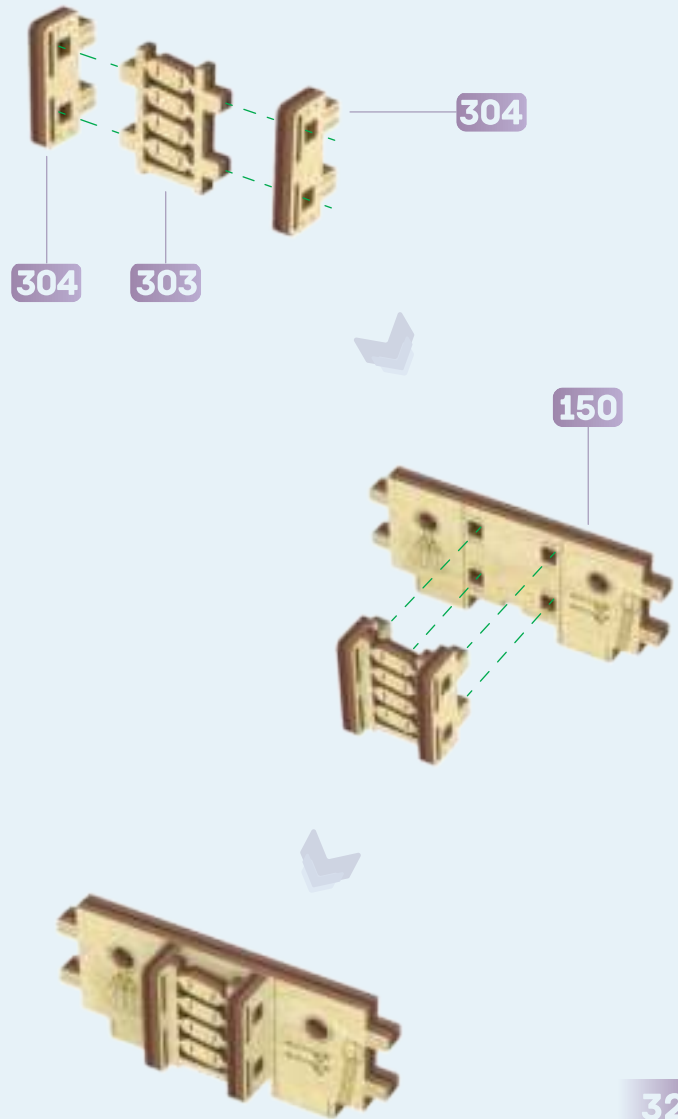
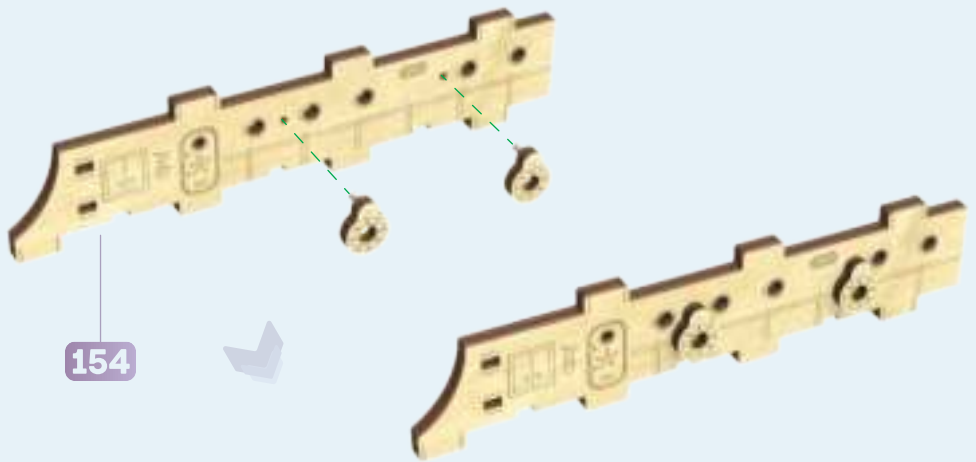
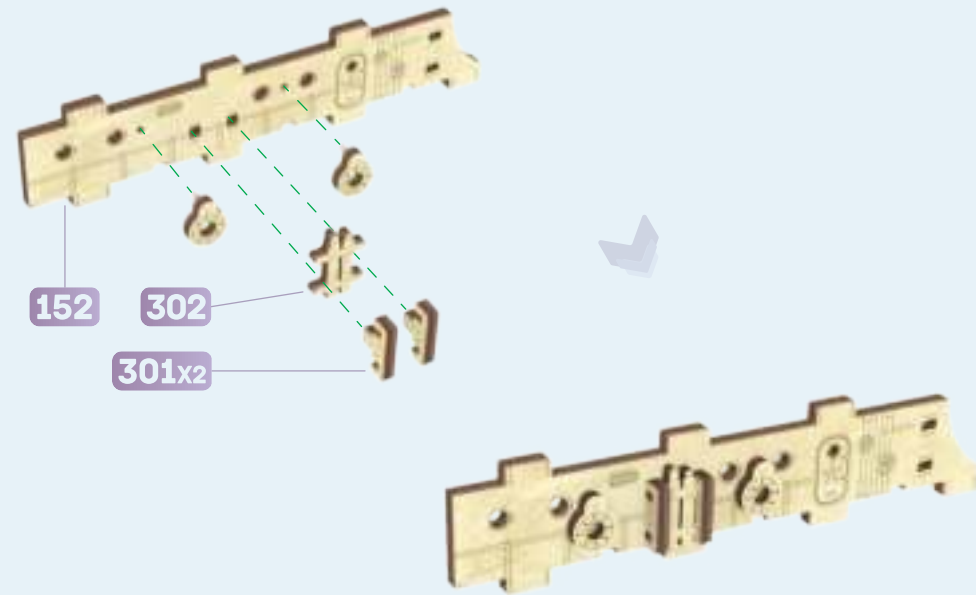
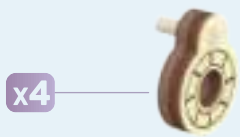
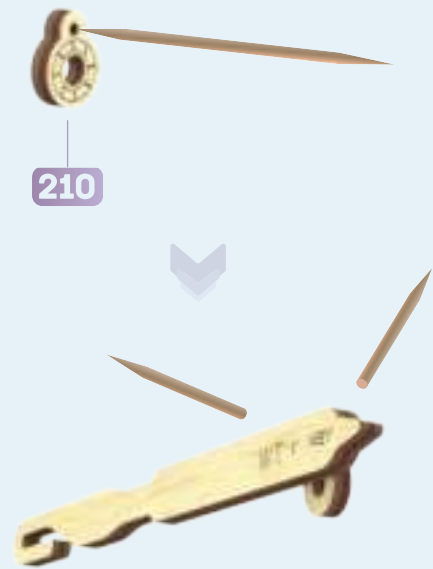
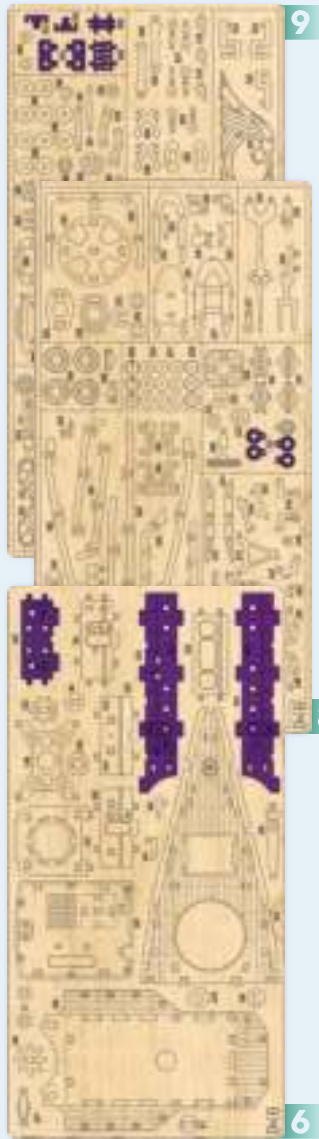



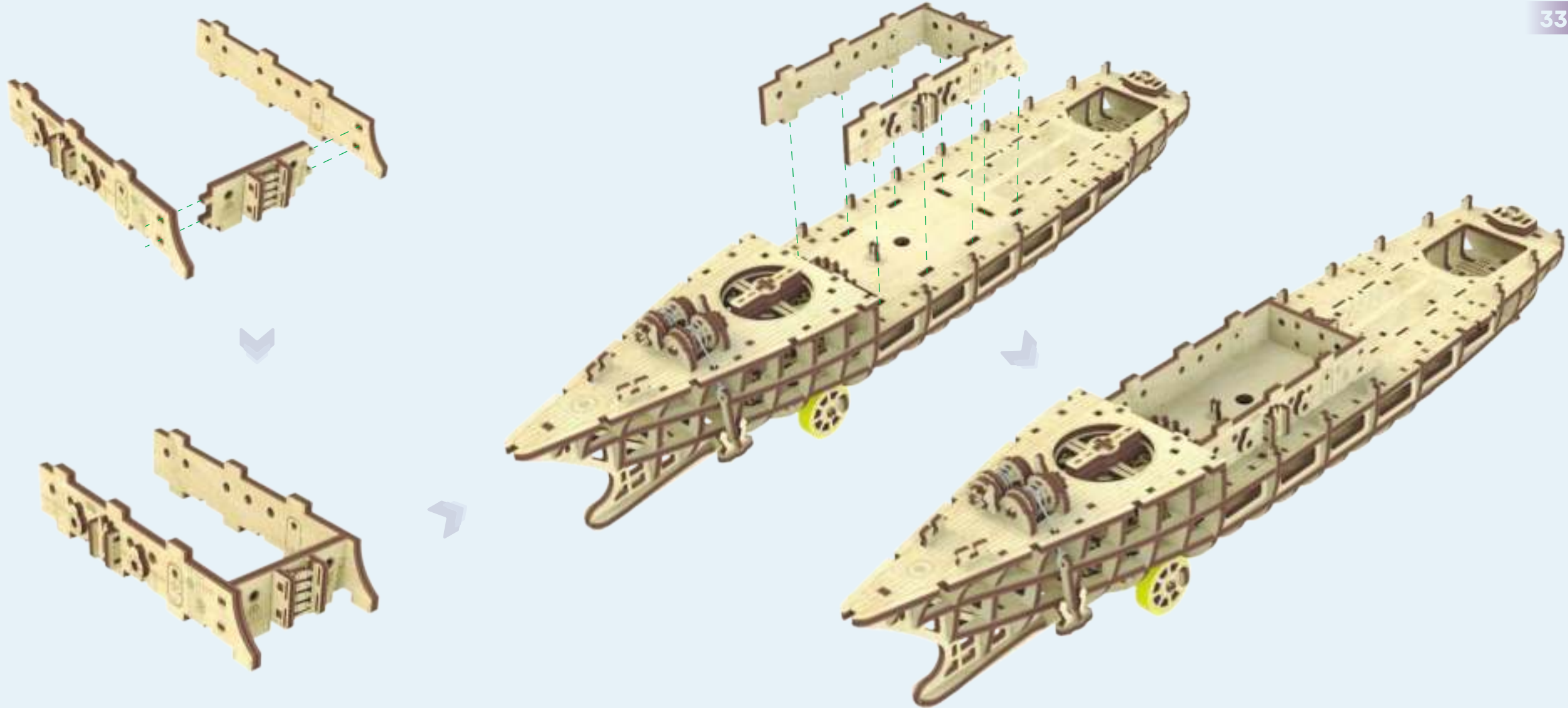

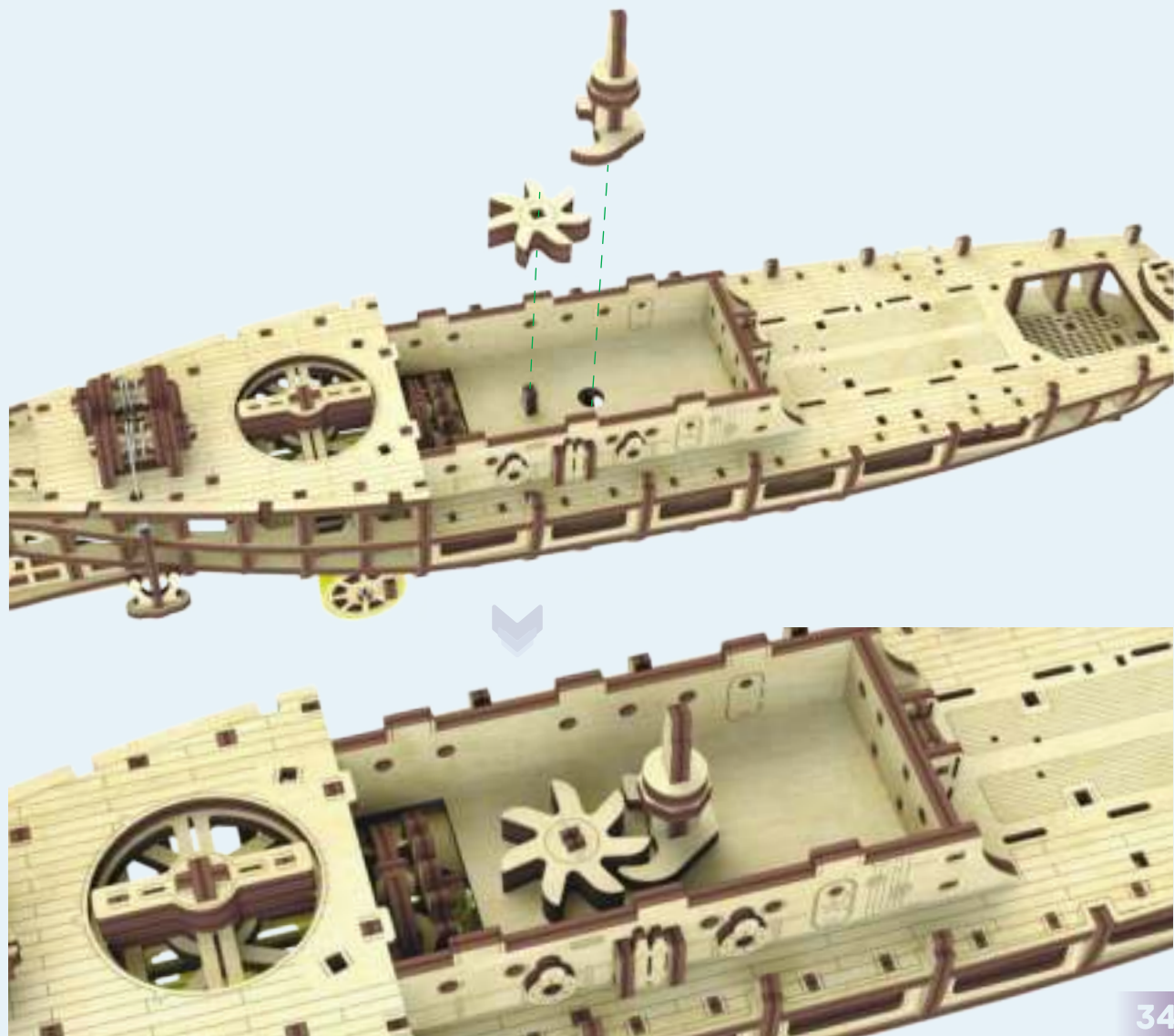



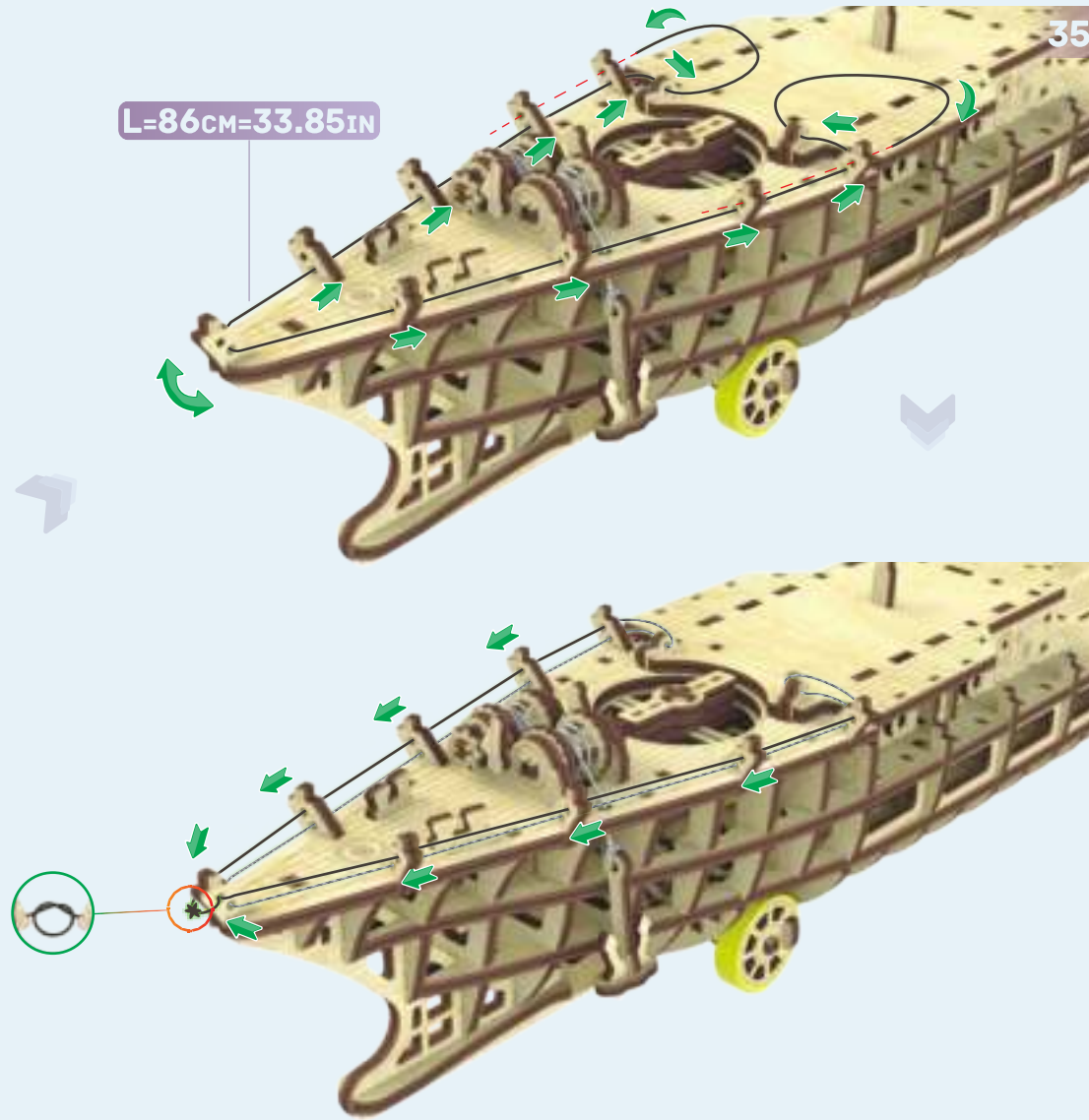
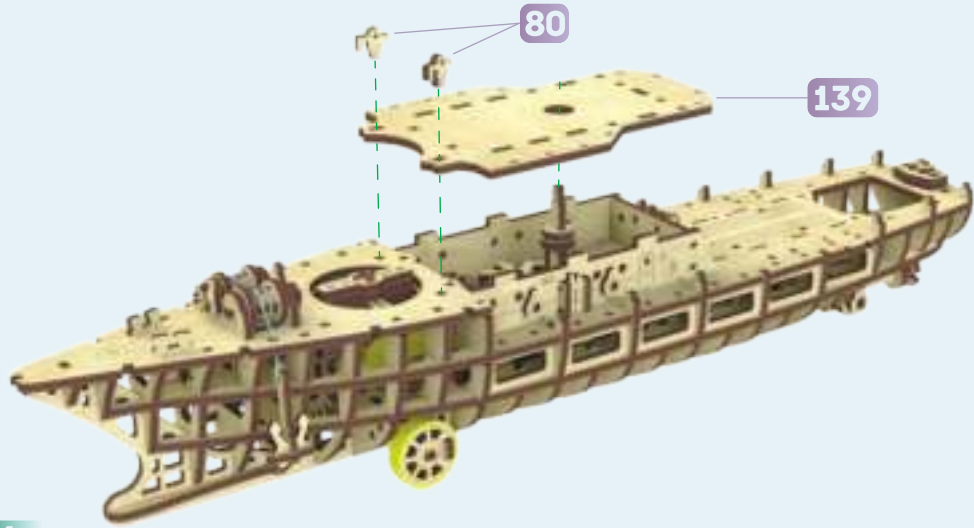



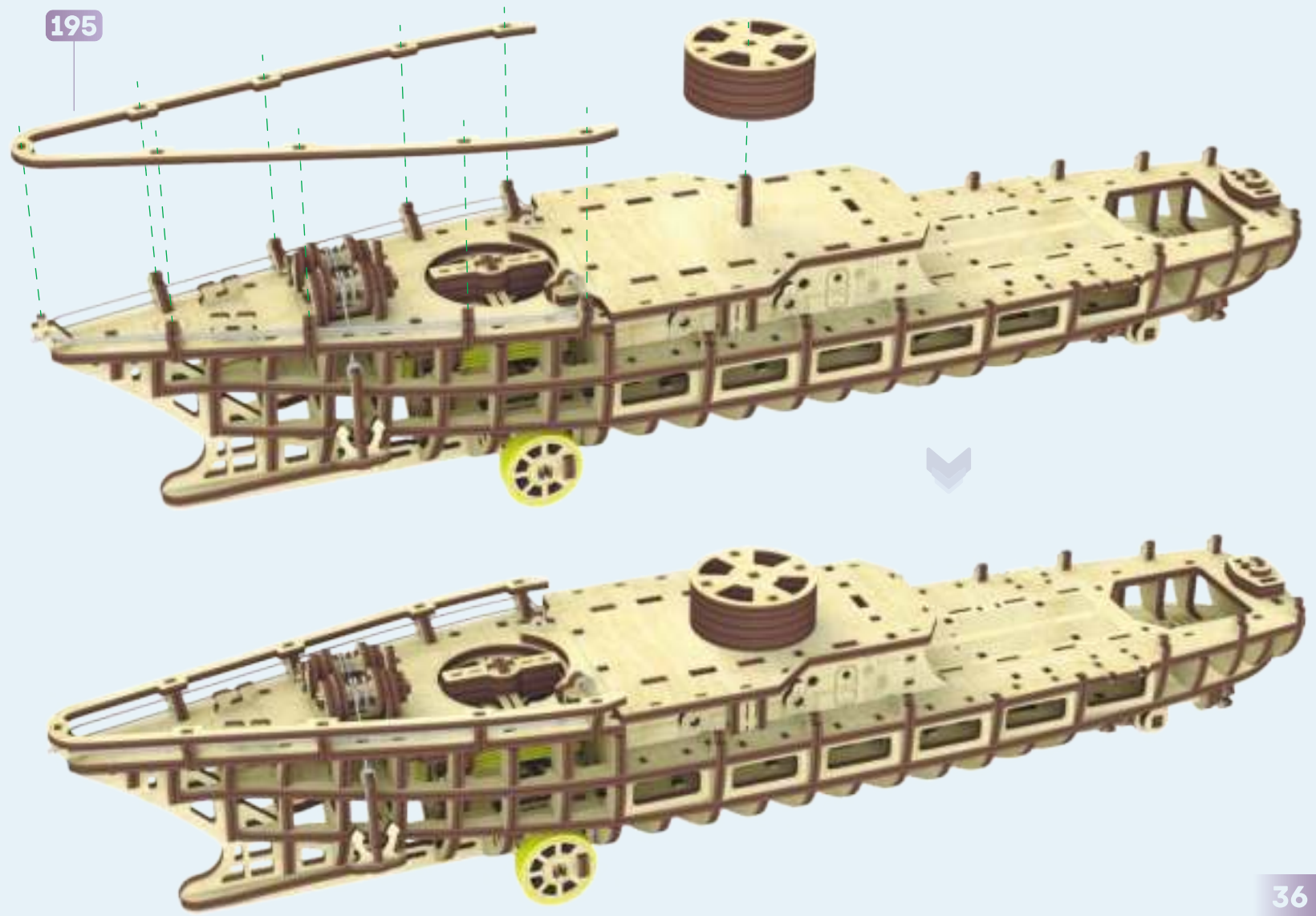
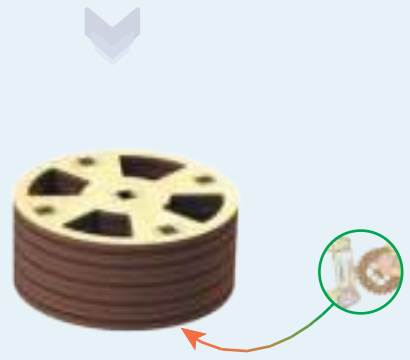
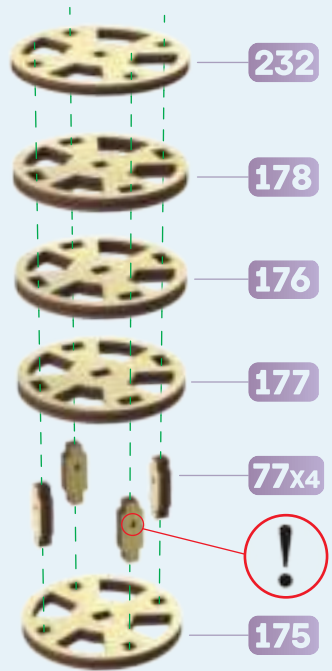
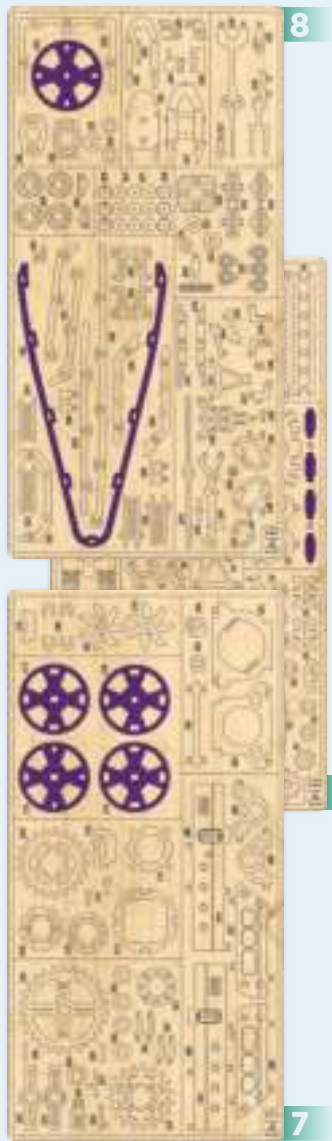

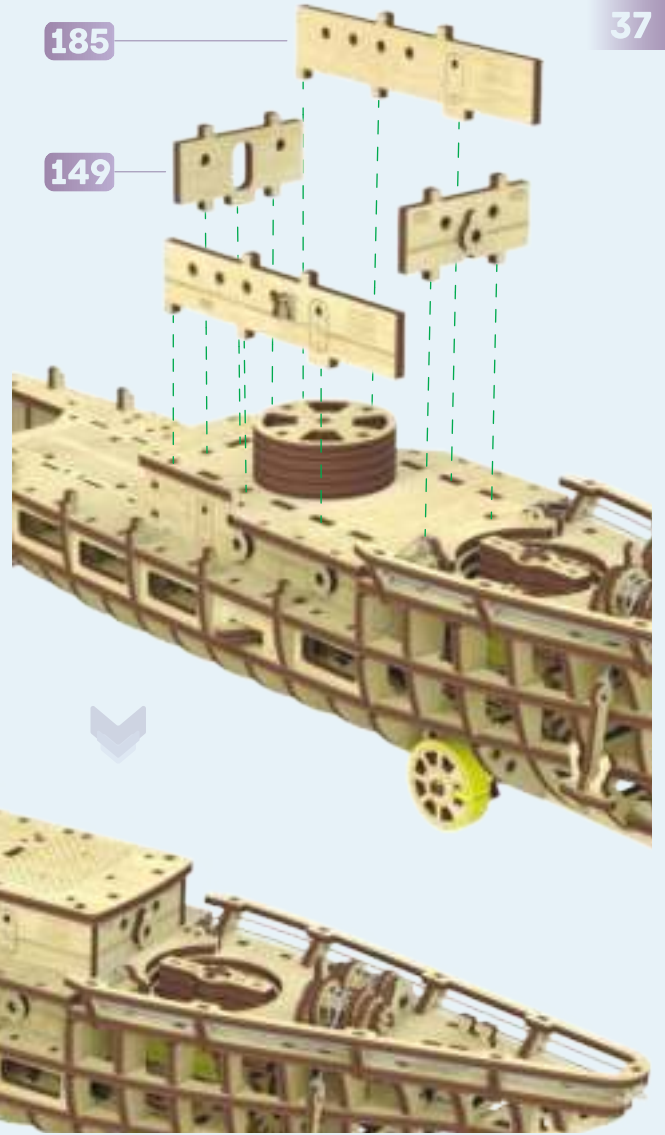
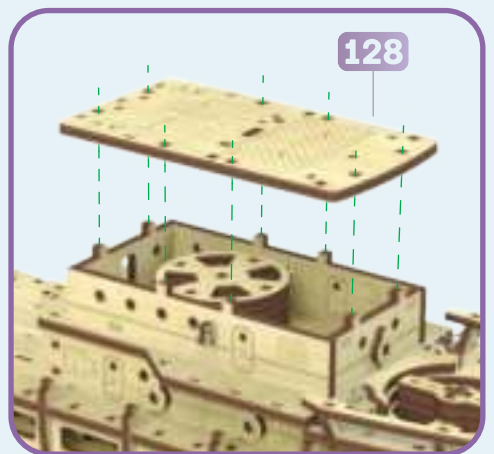
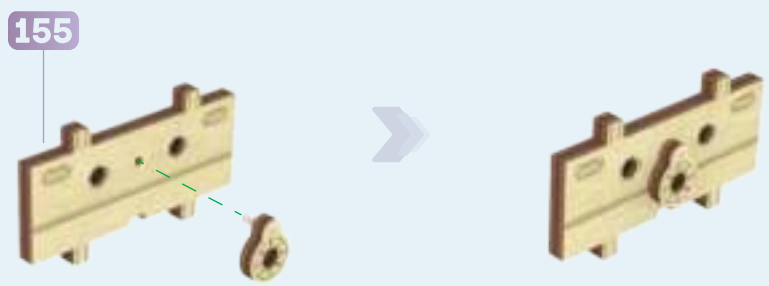
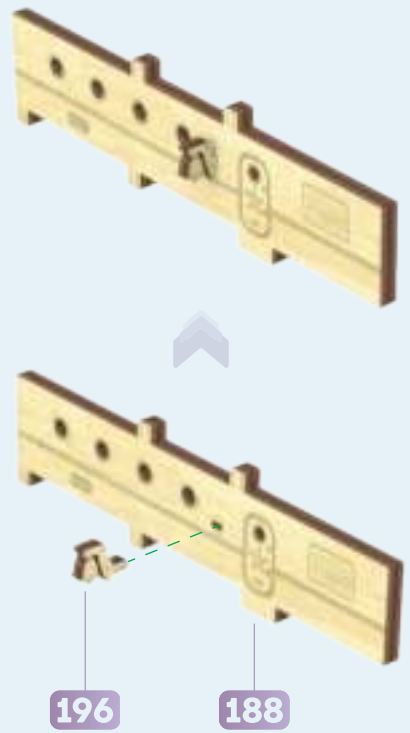
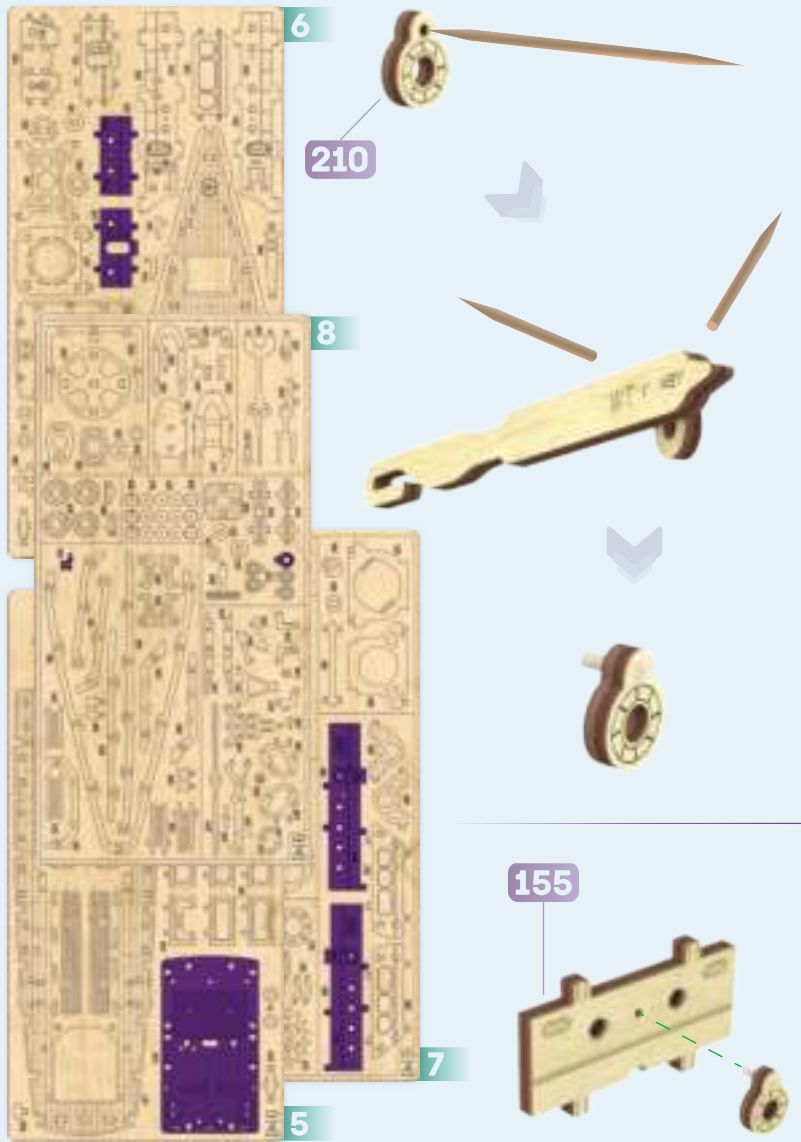



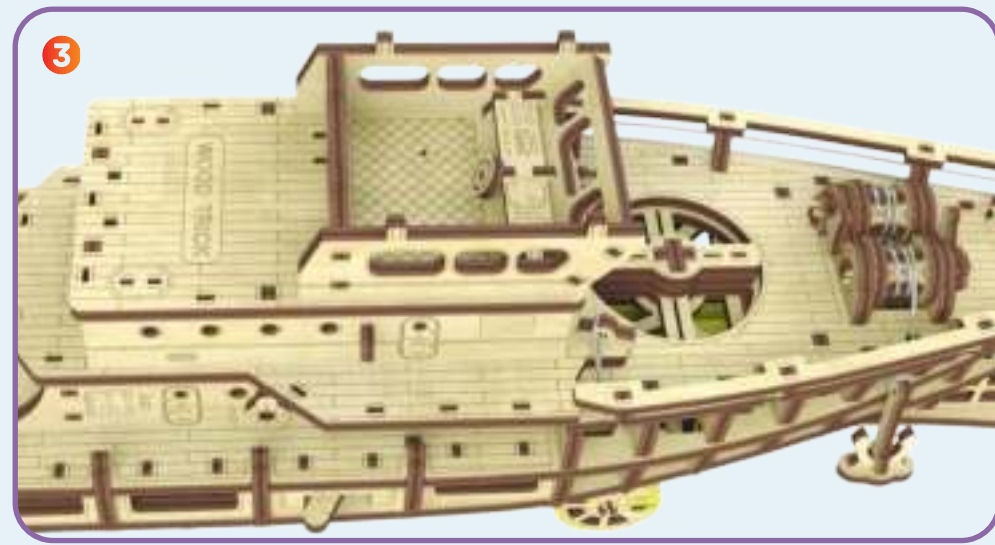
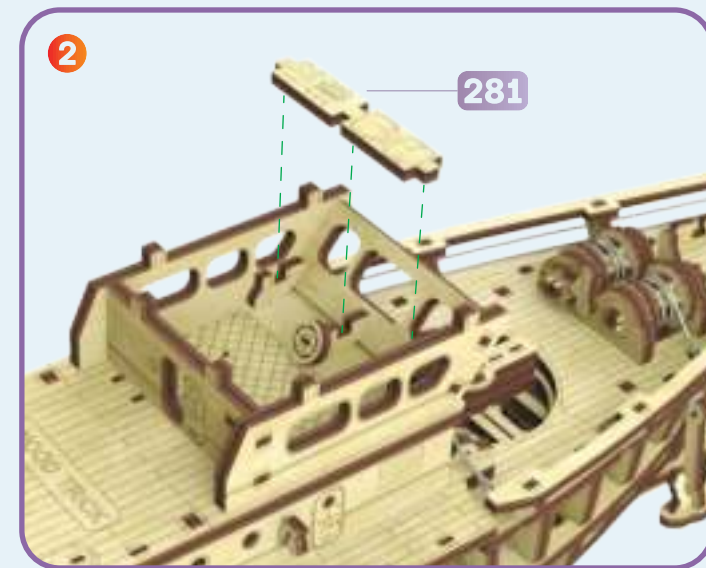
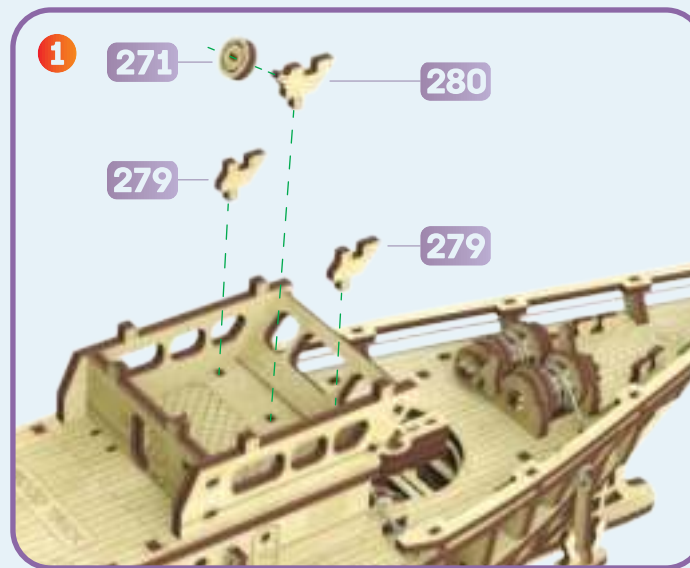
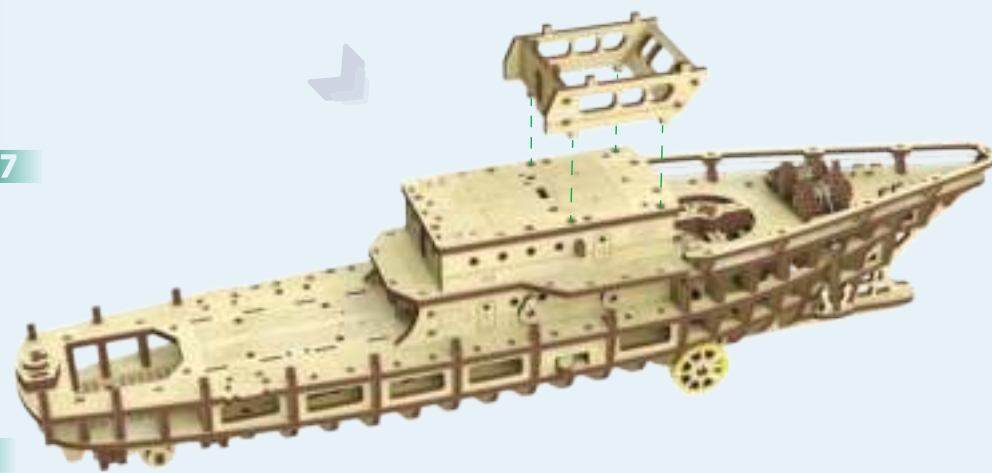



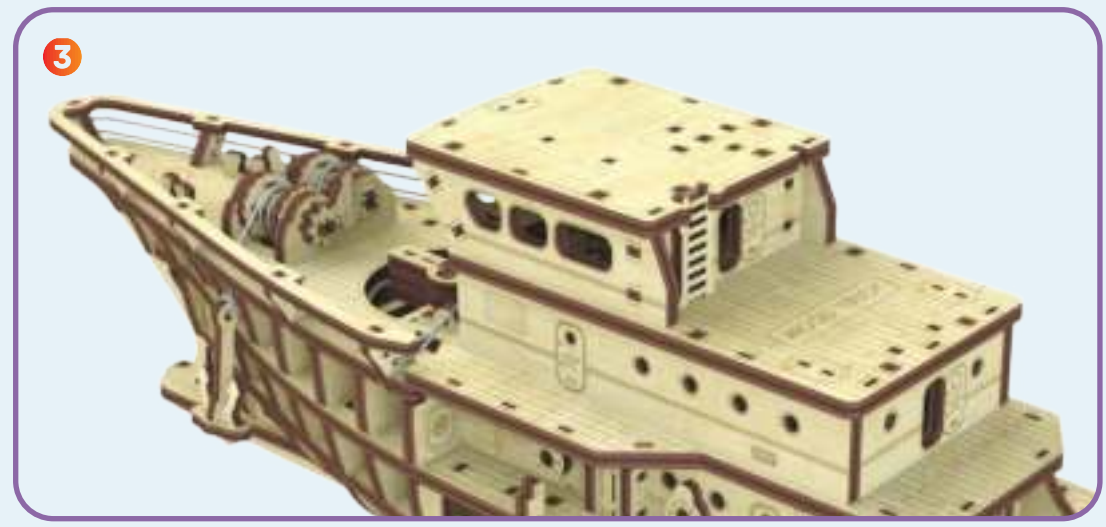
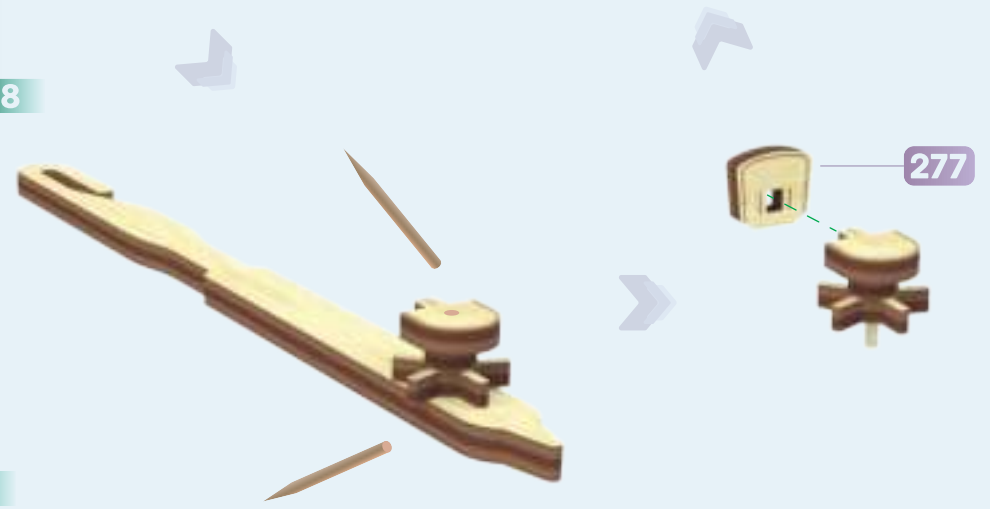
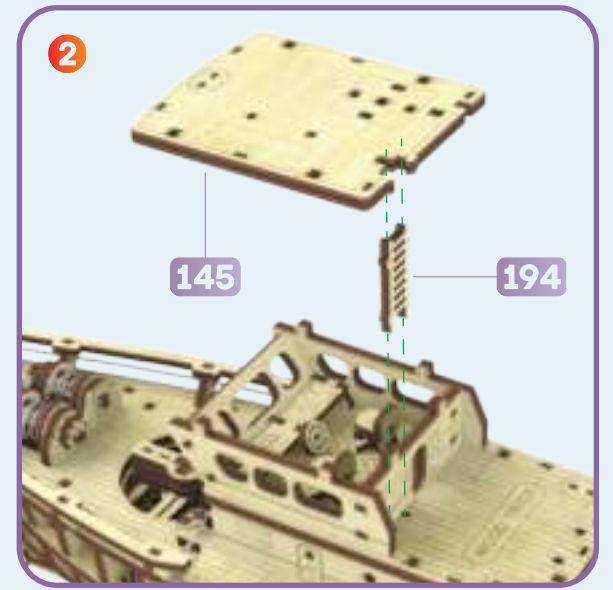
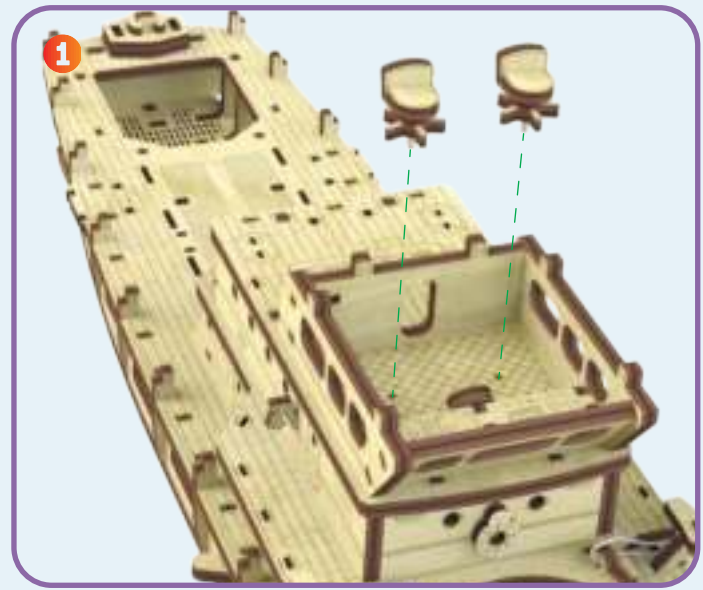
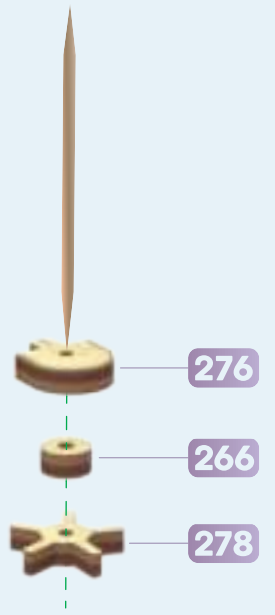

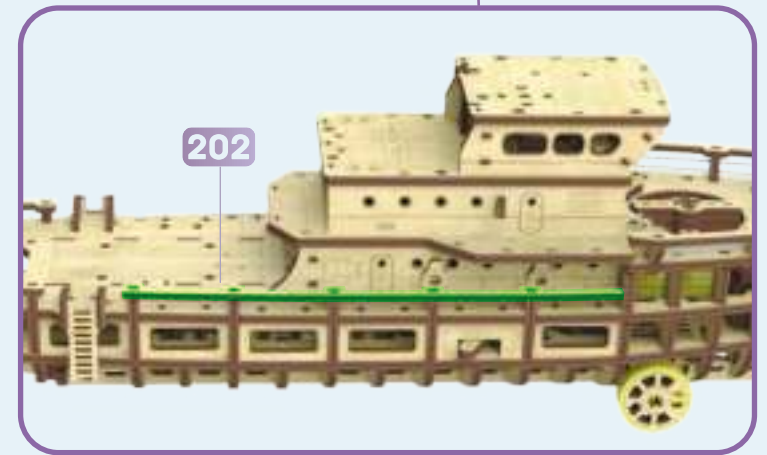
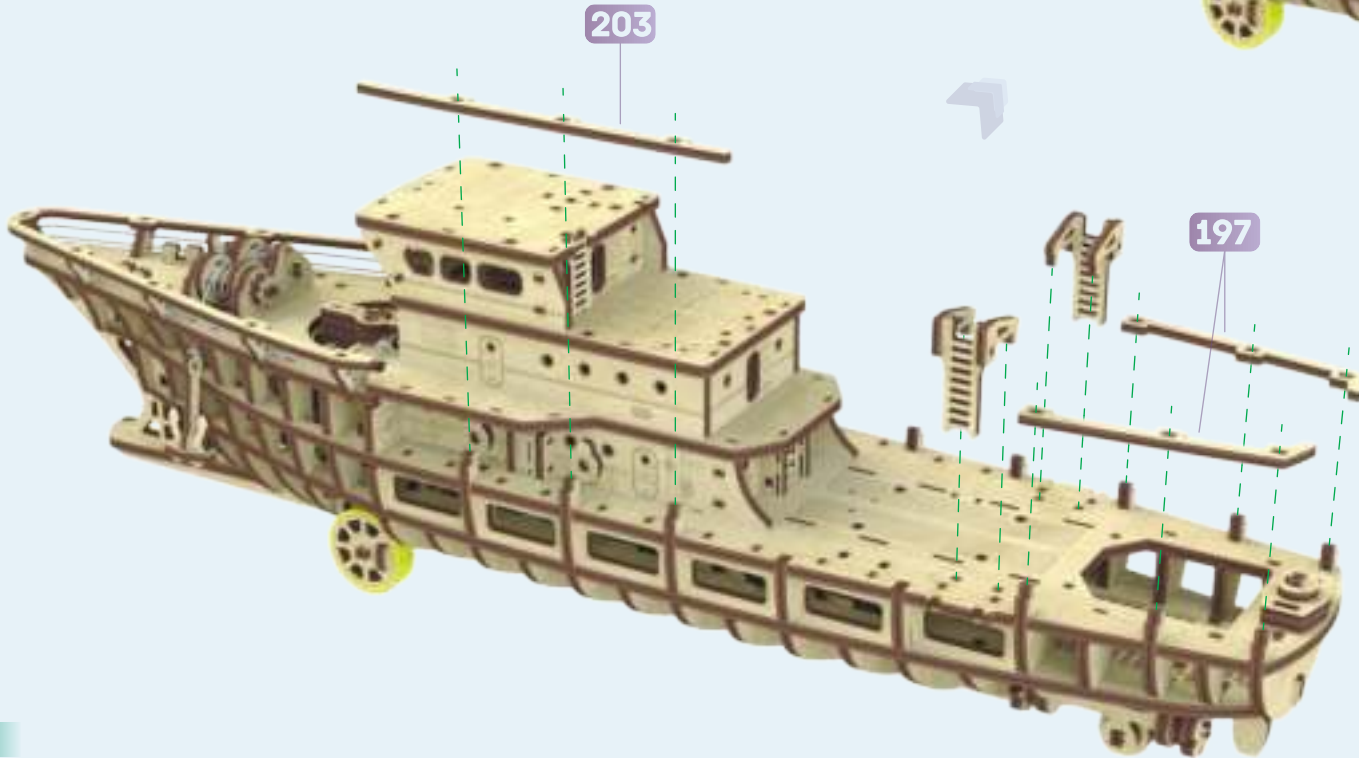
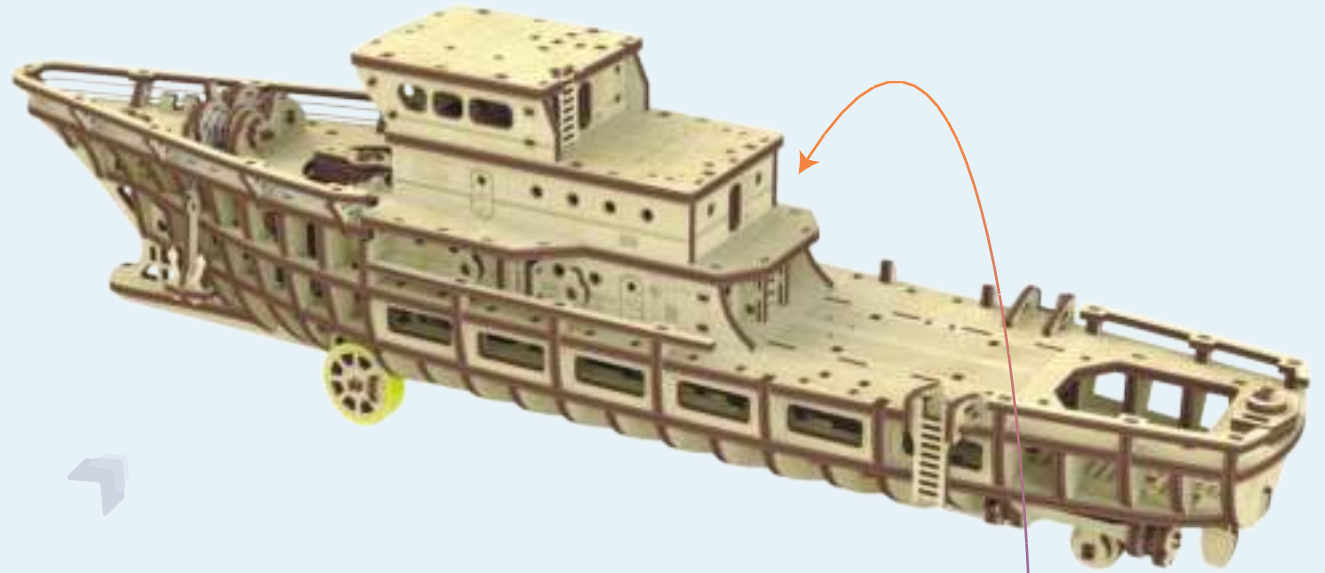
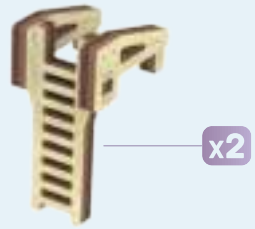
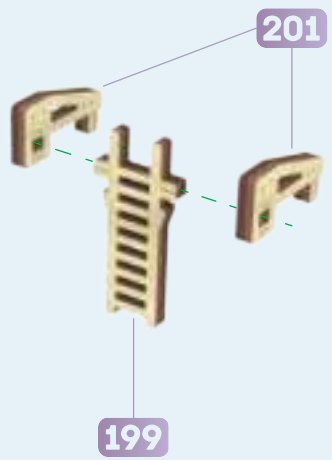



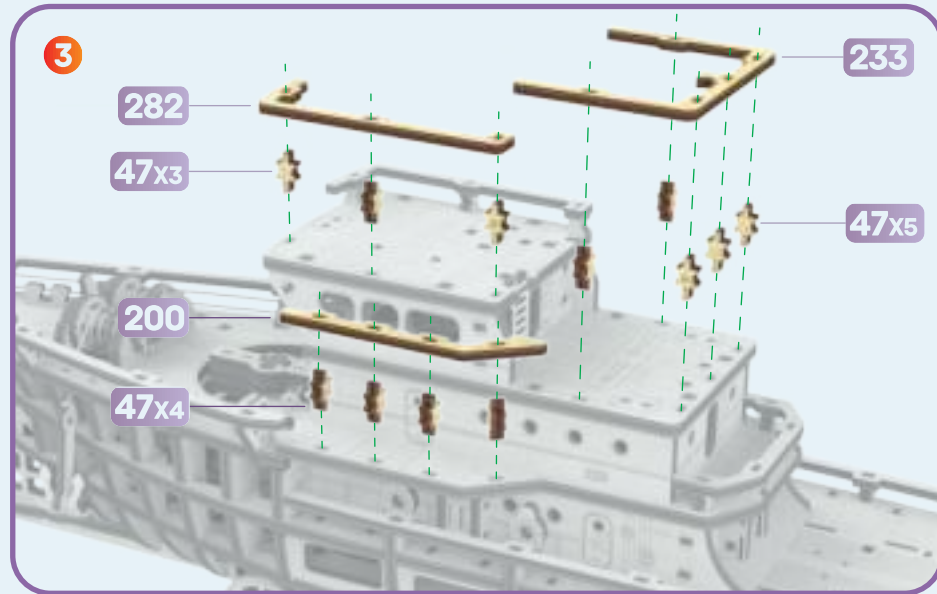
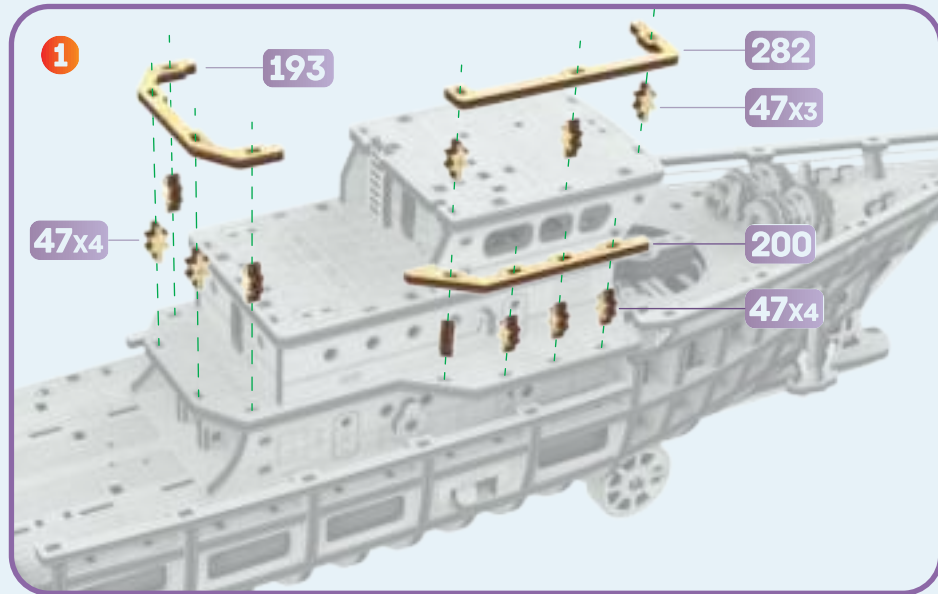



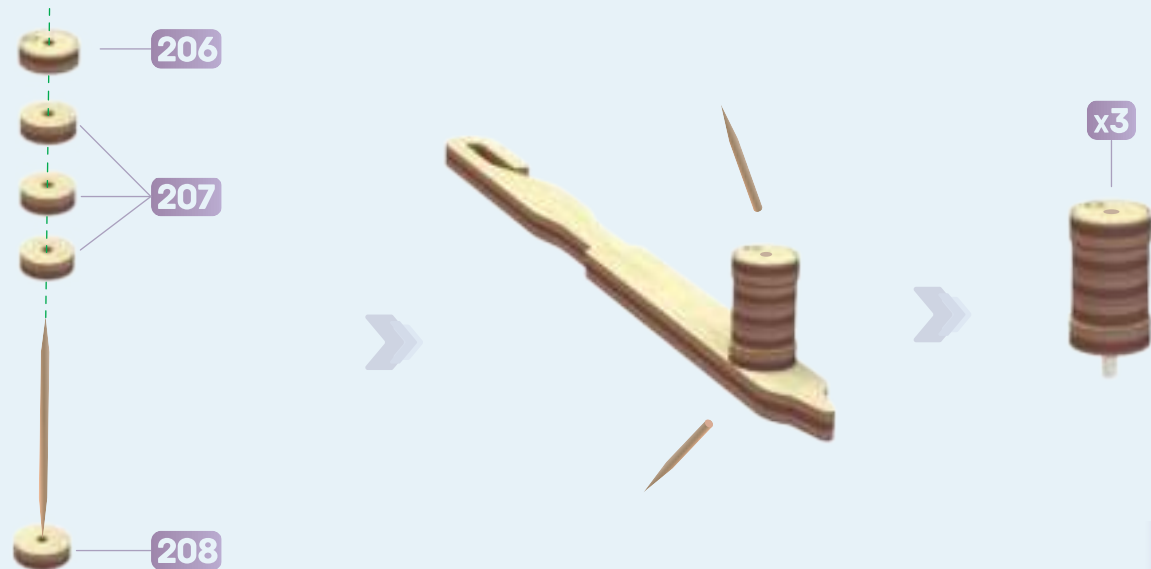
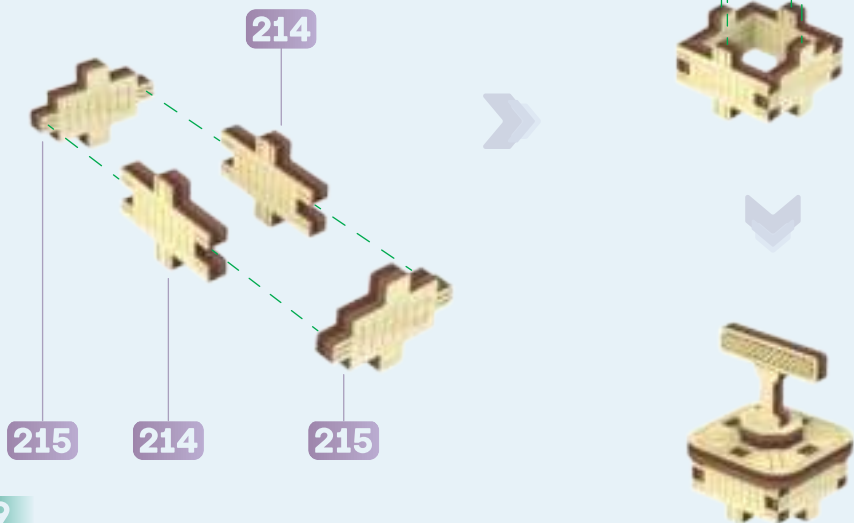
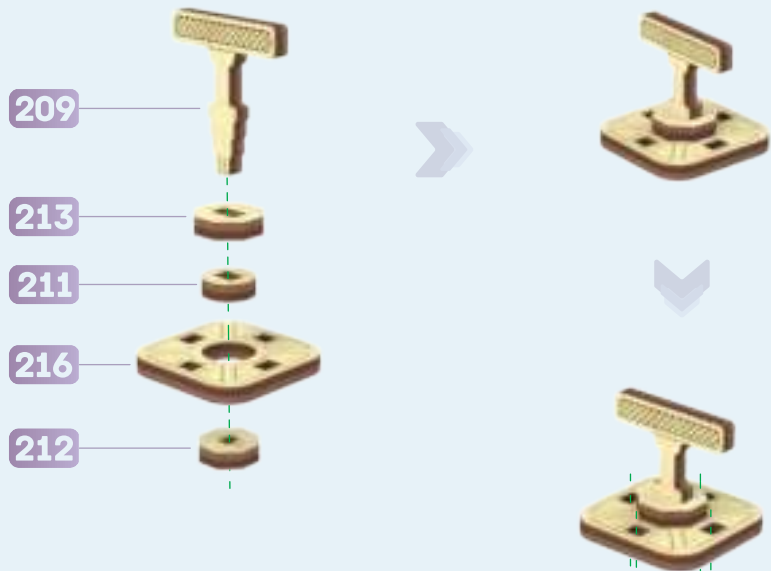



5

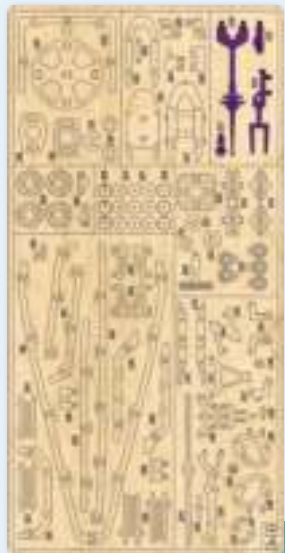

8

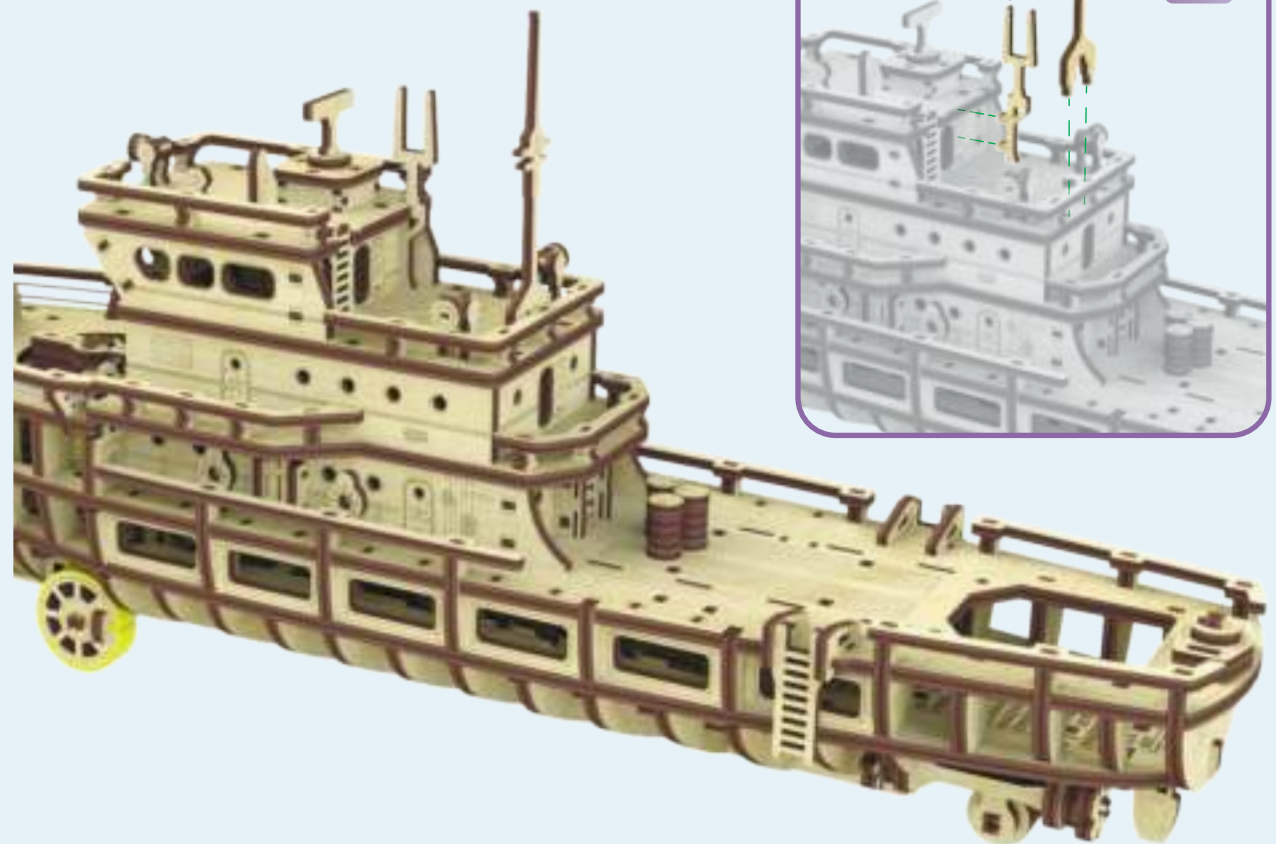
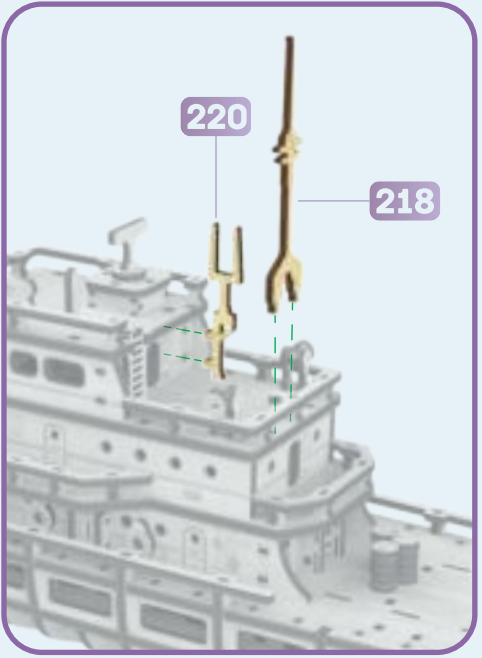
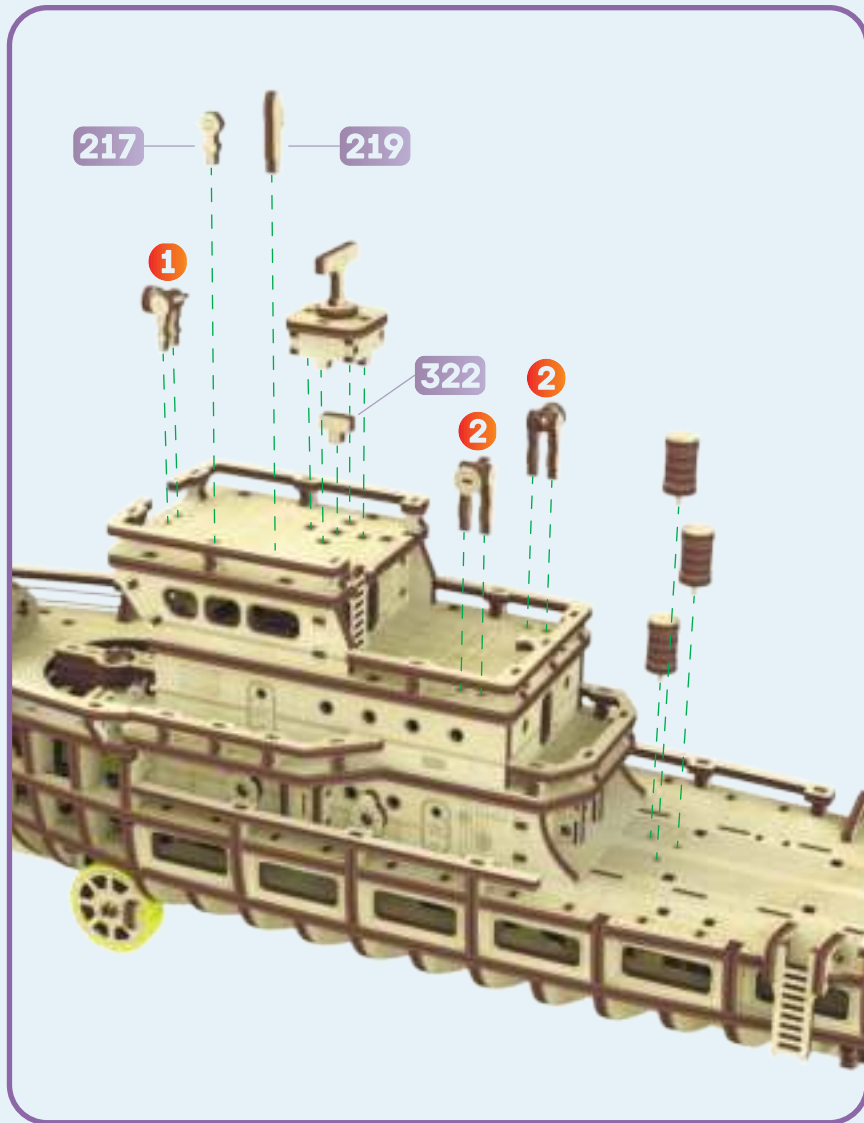



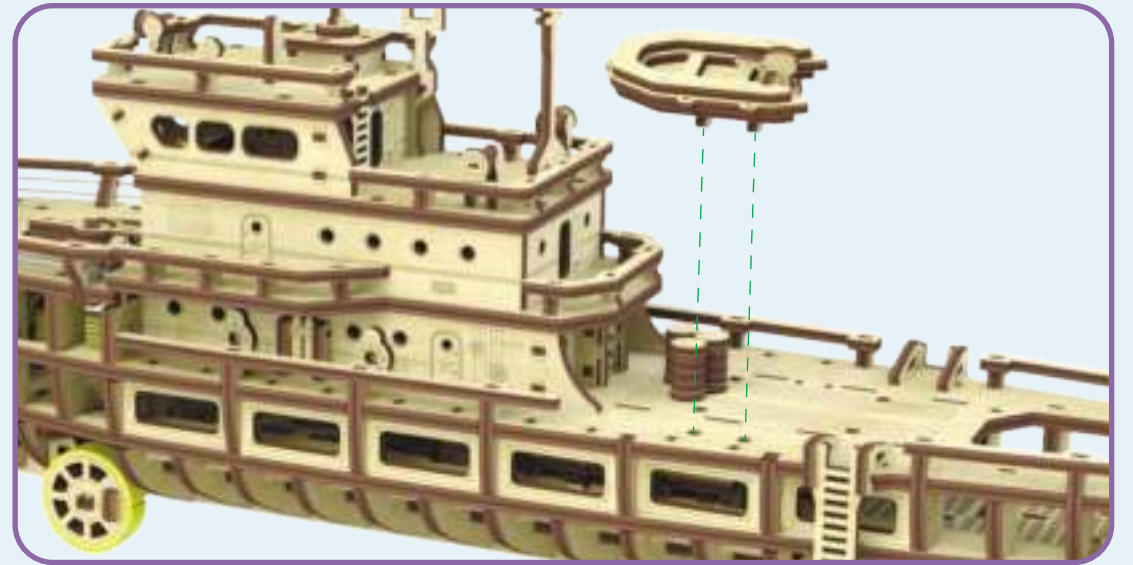
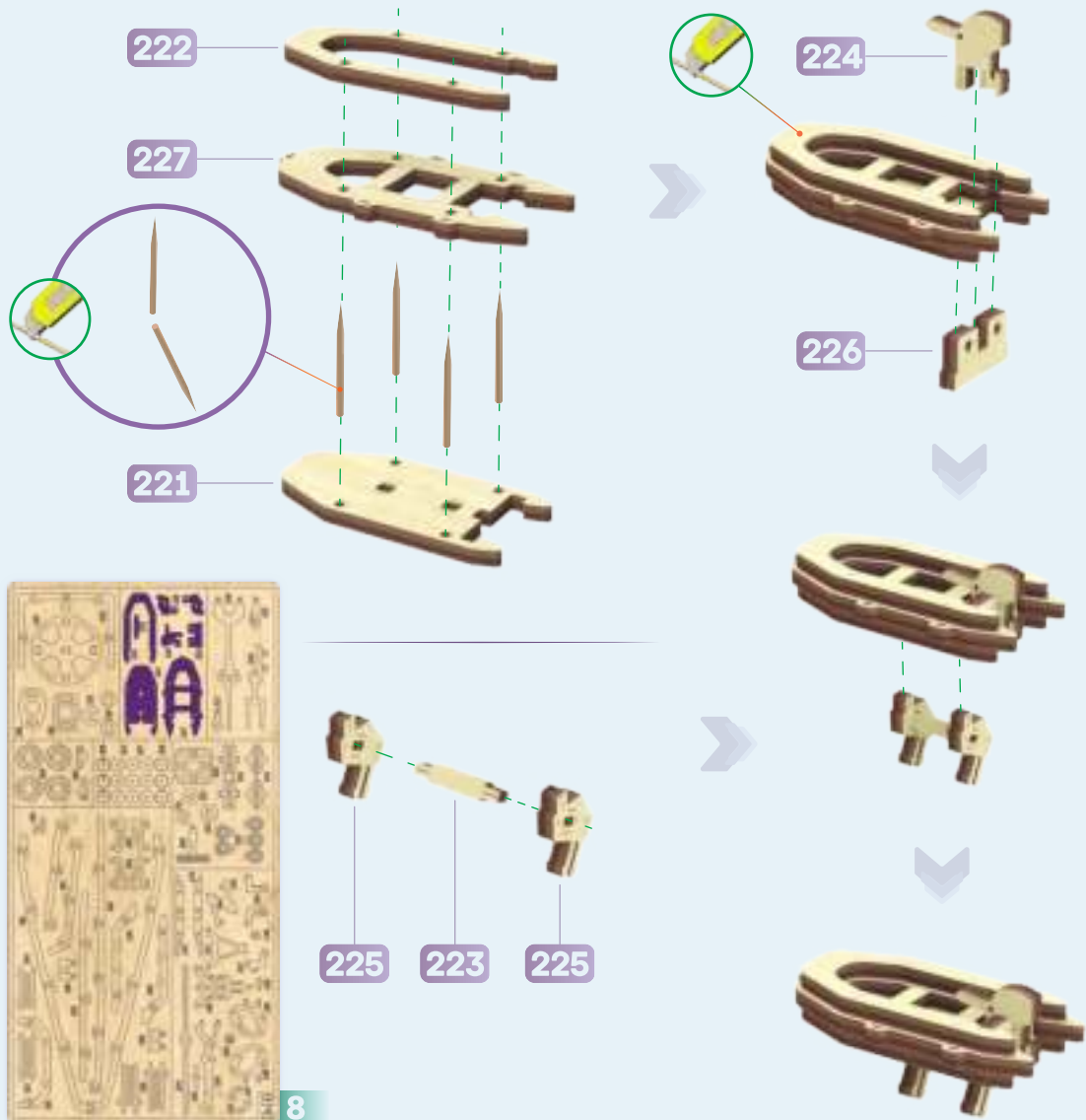



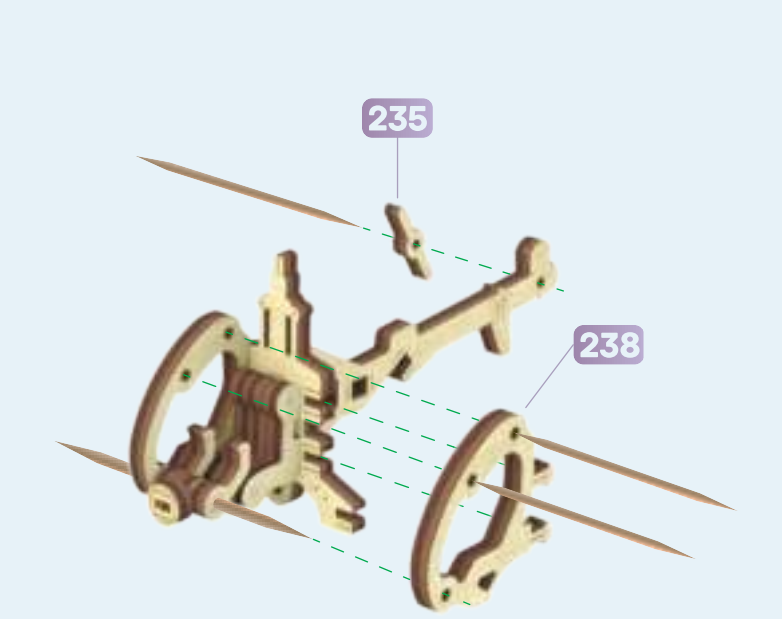
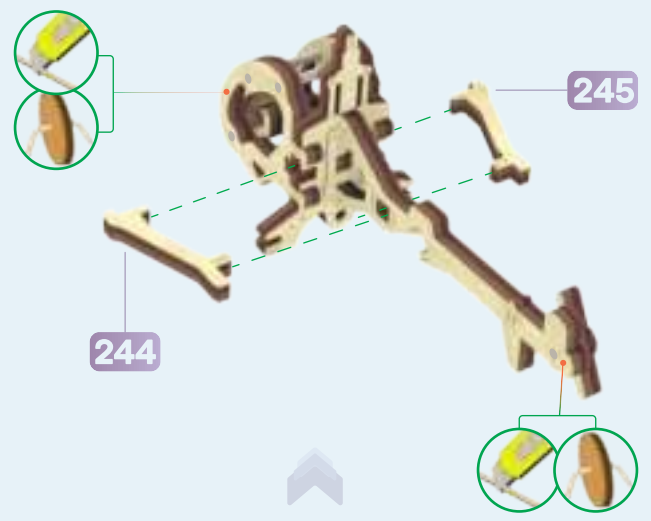
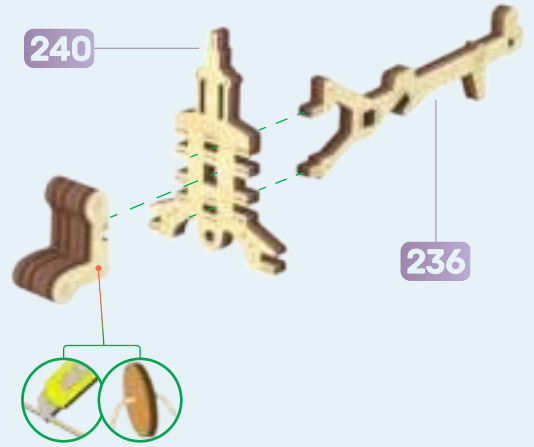



3

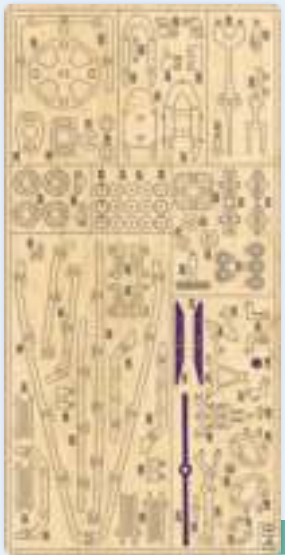
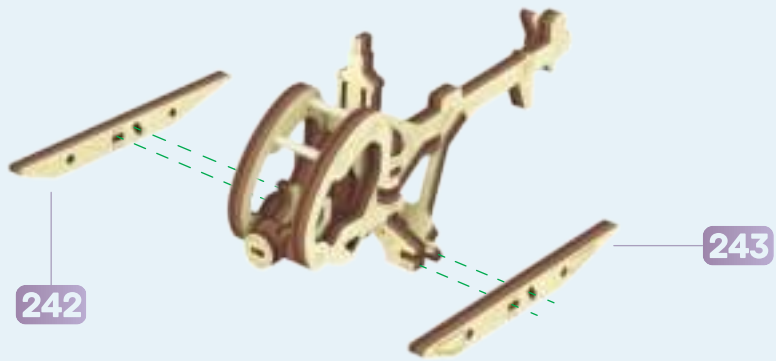

8

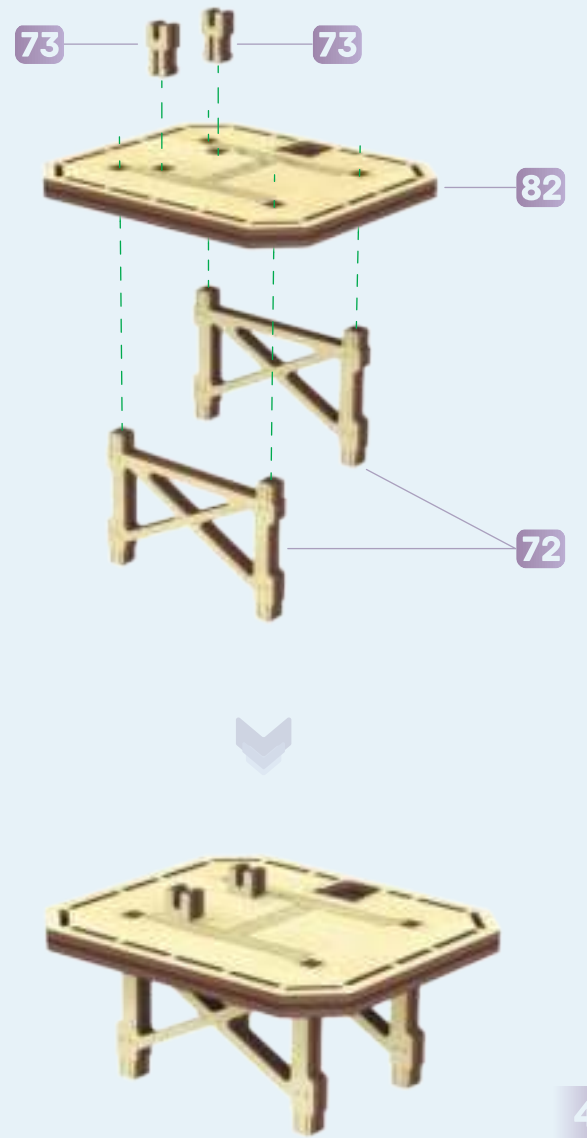
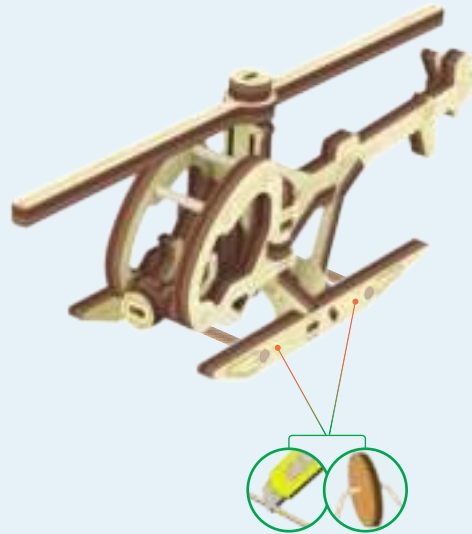
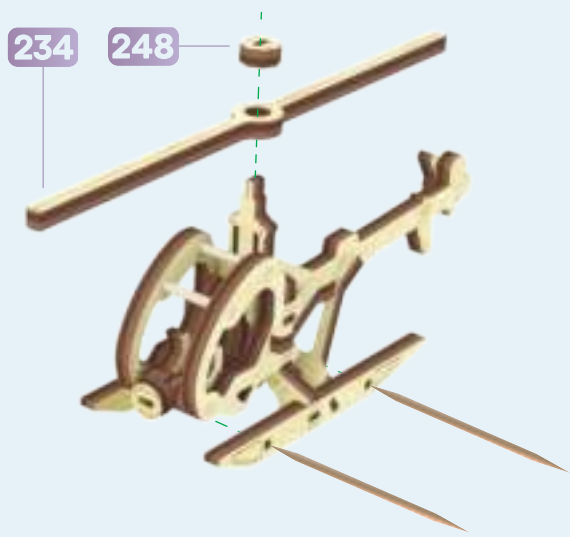

46



8

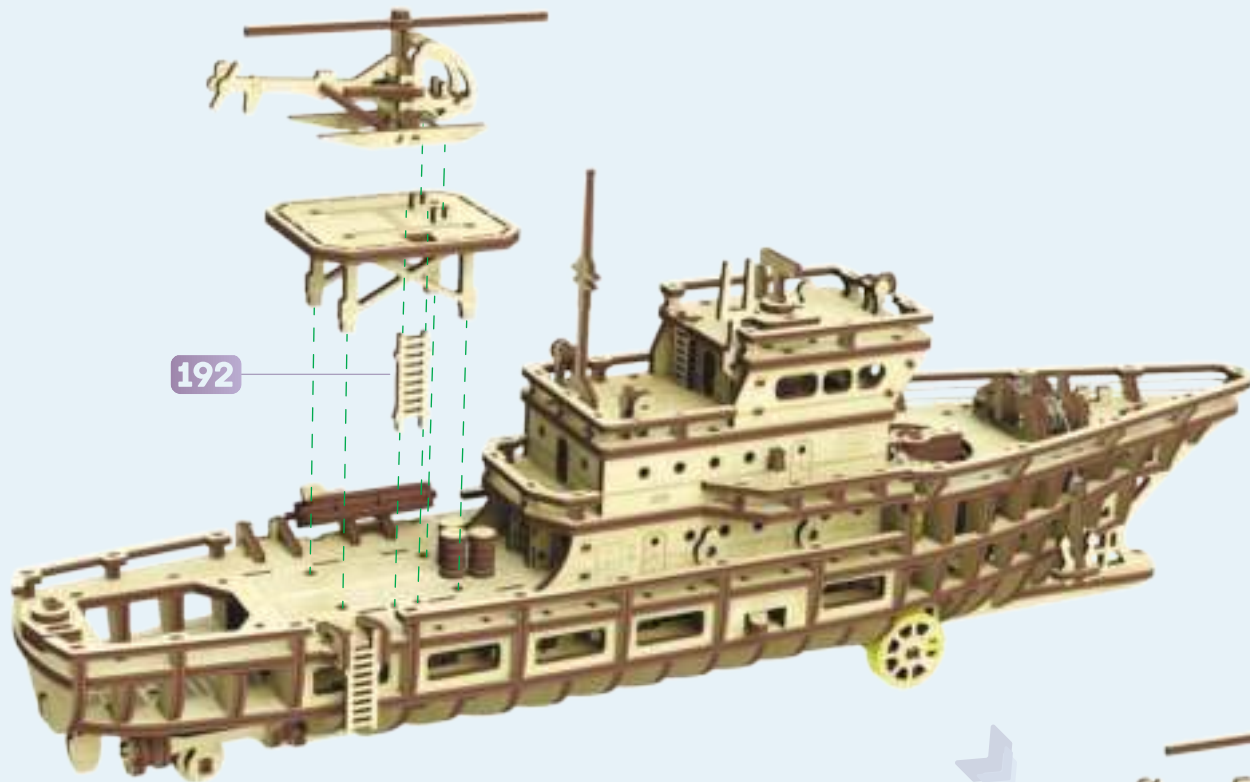



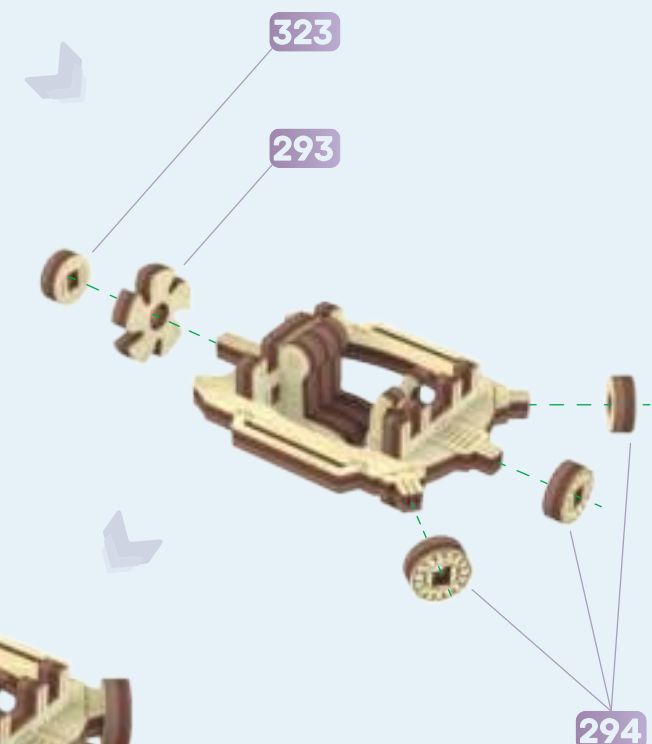
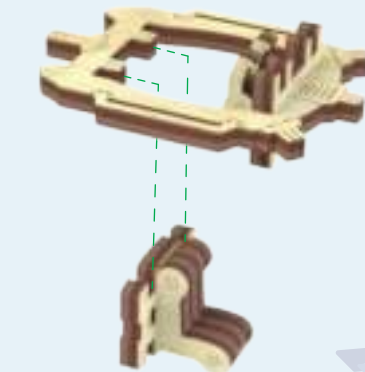
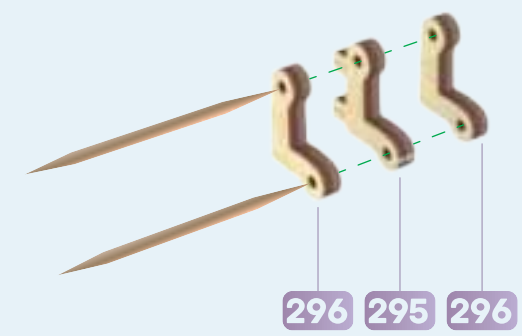
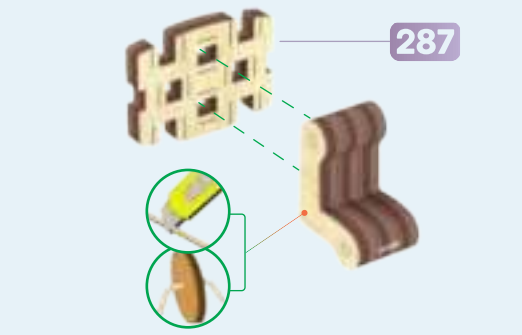
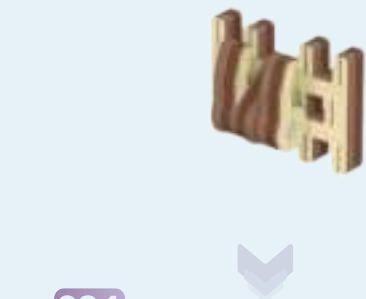
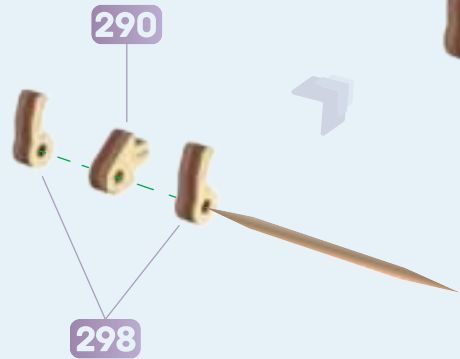

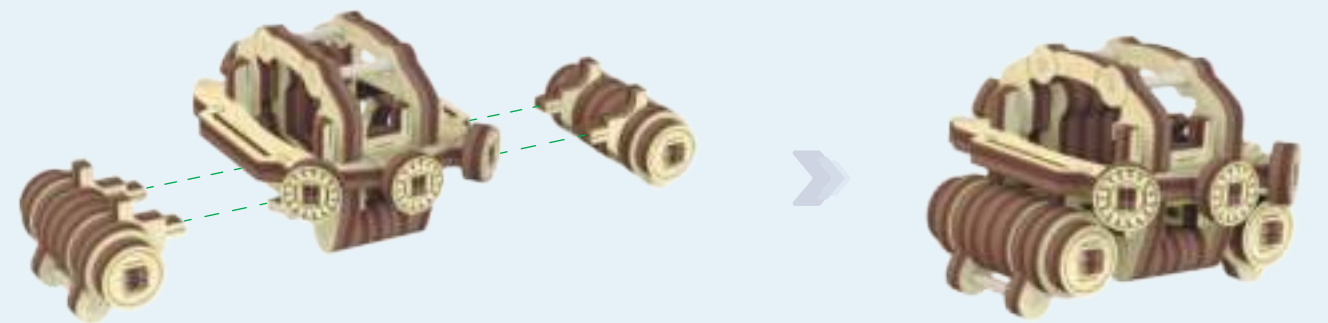
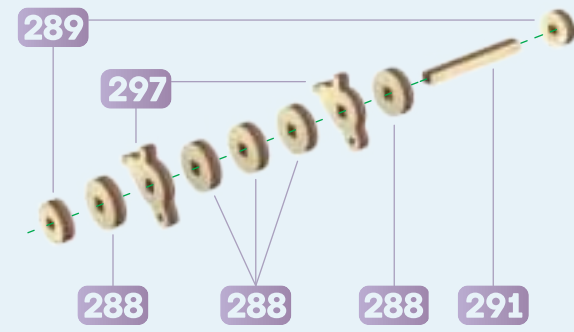
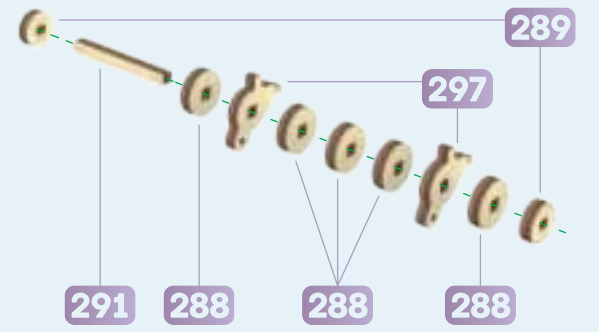
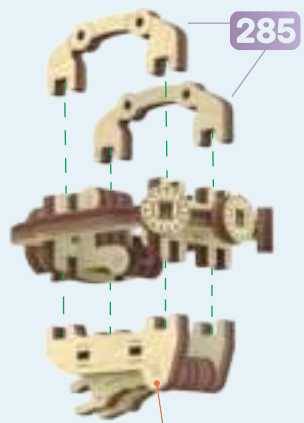
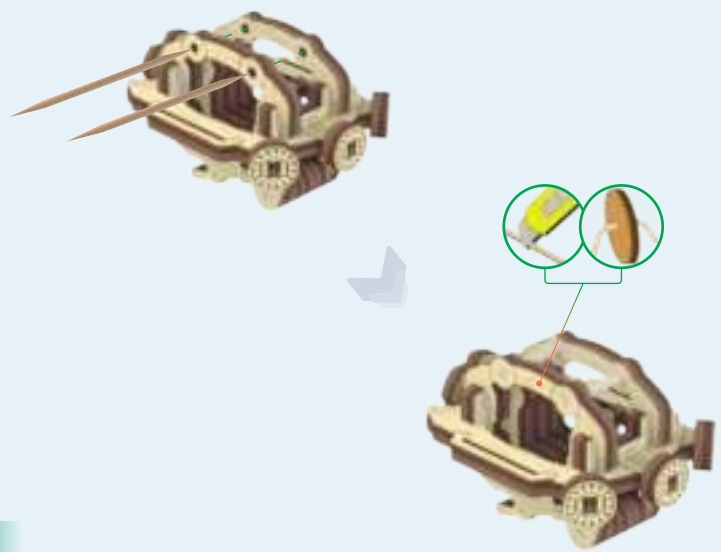
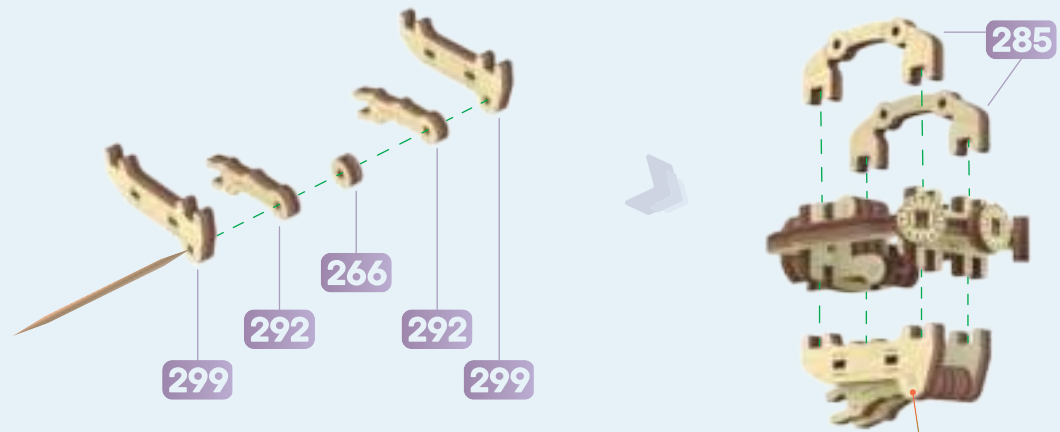

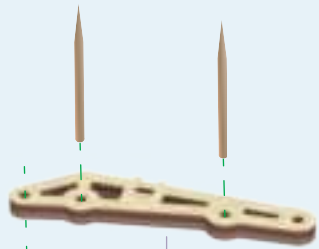
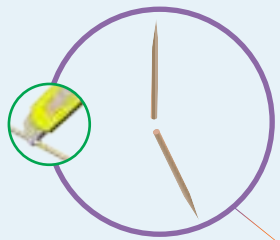

258

251



266

264

266

264

266

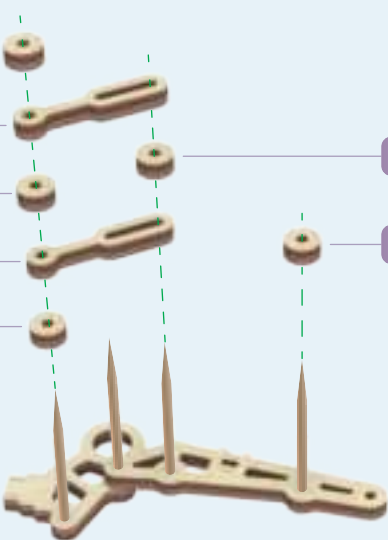

266

266



9

256

267

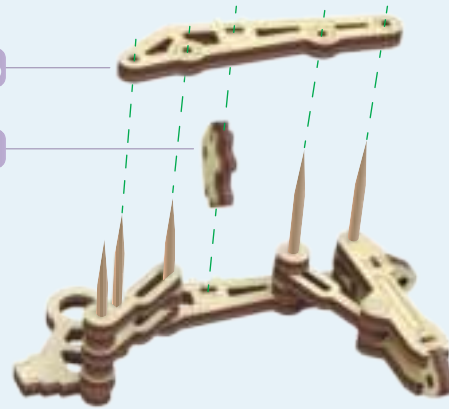

266

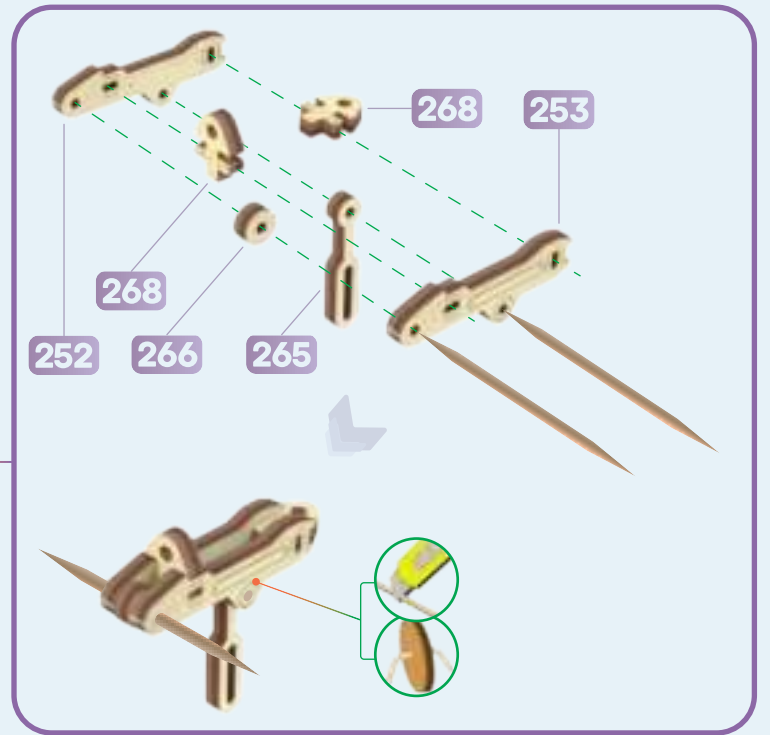
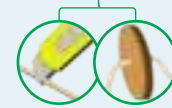
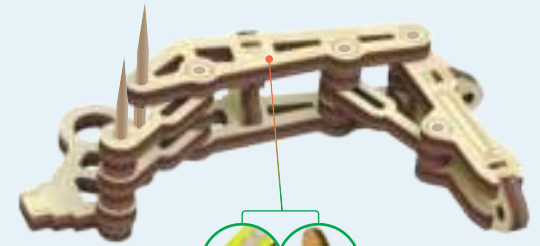
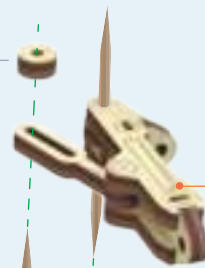

252

268

266

265

268

253

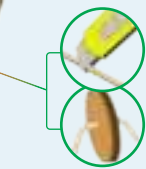



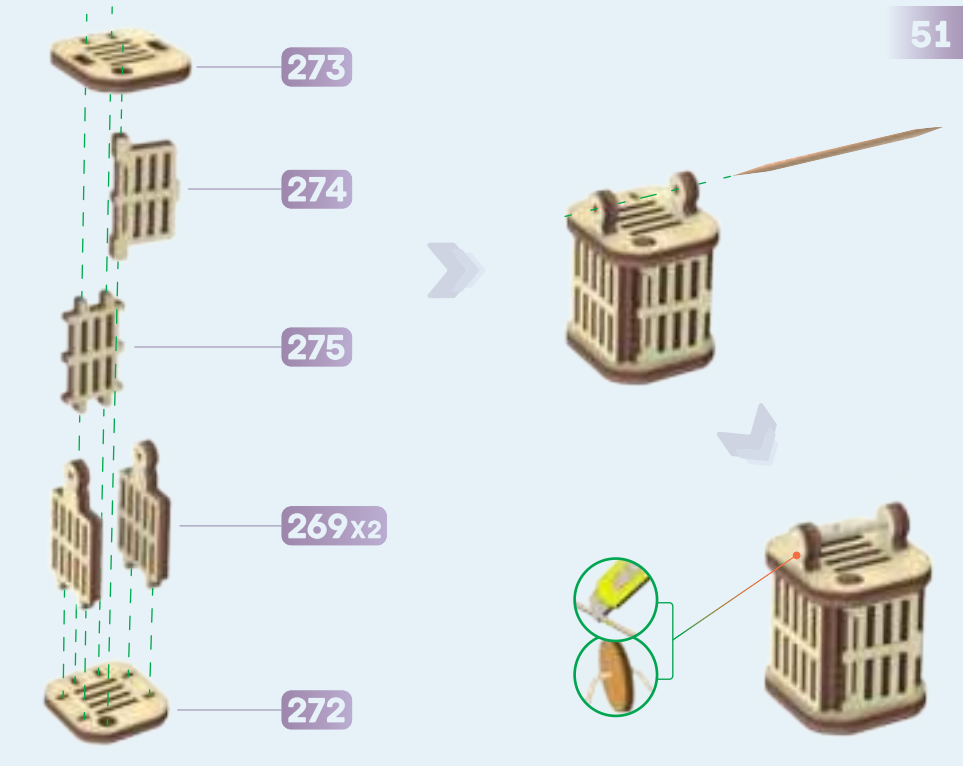
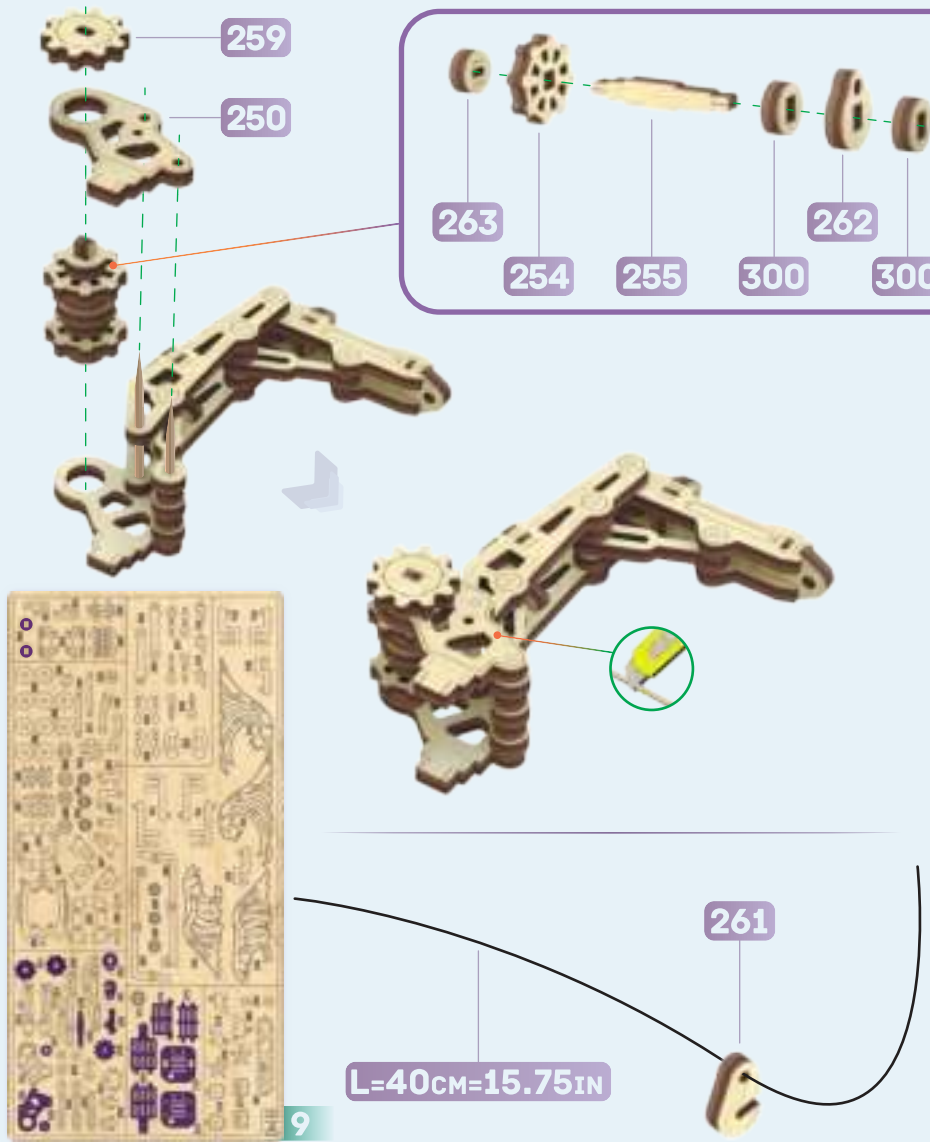

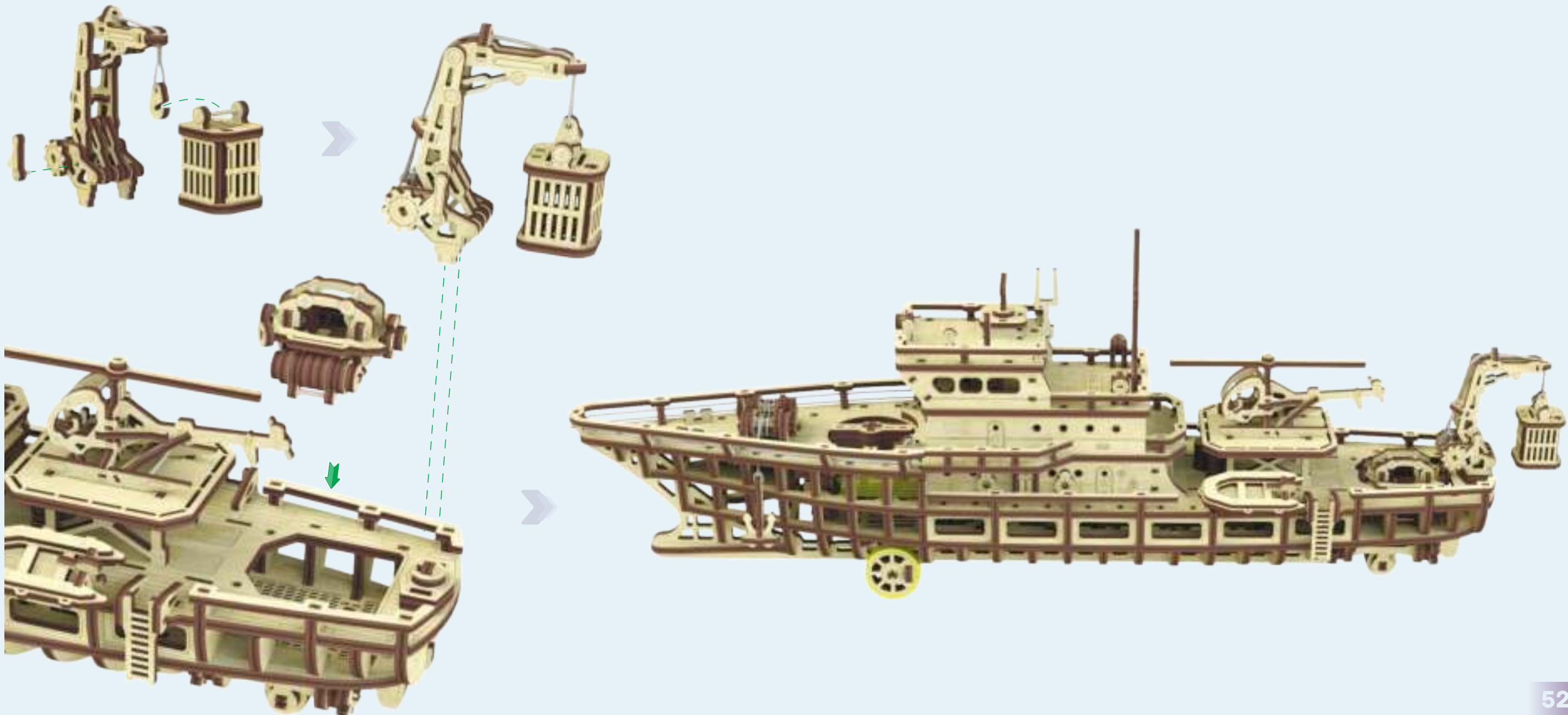

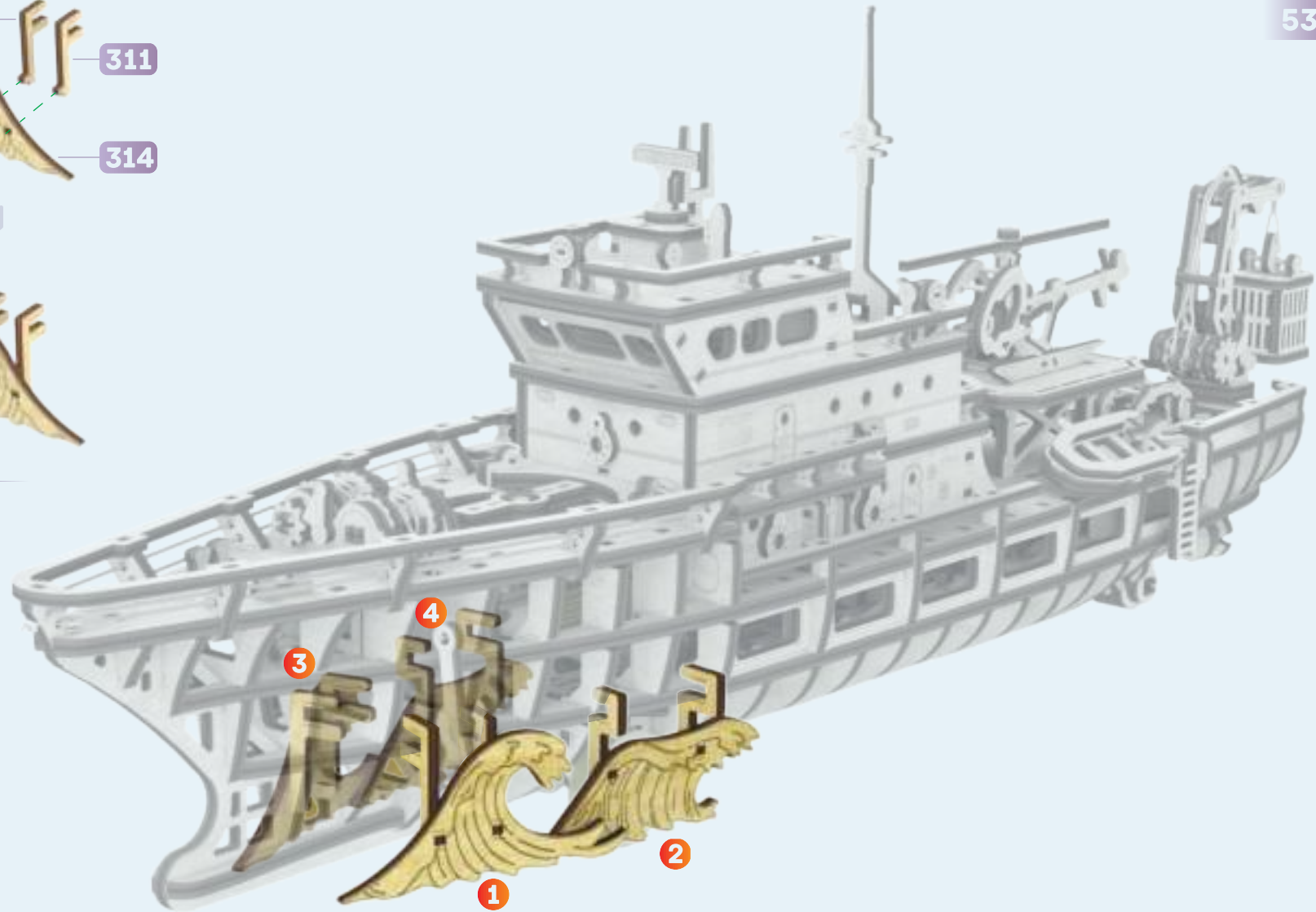
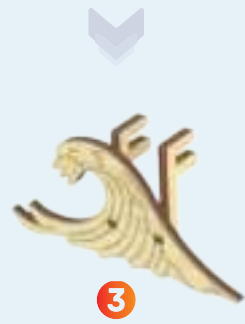
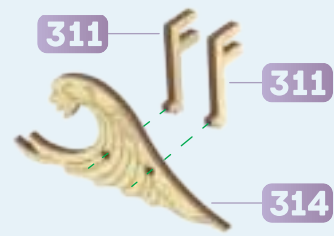



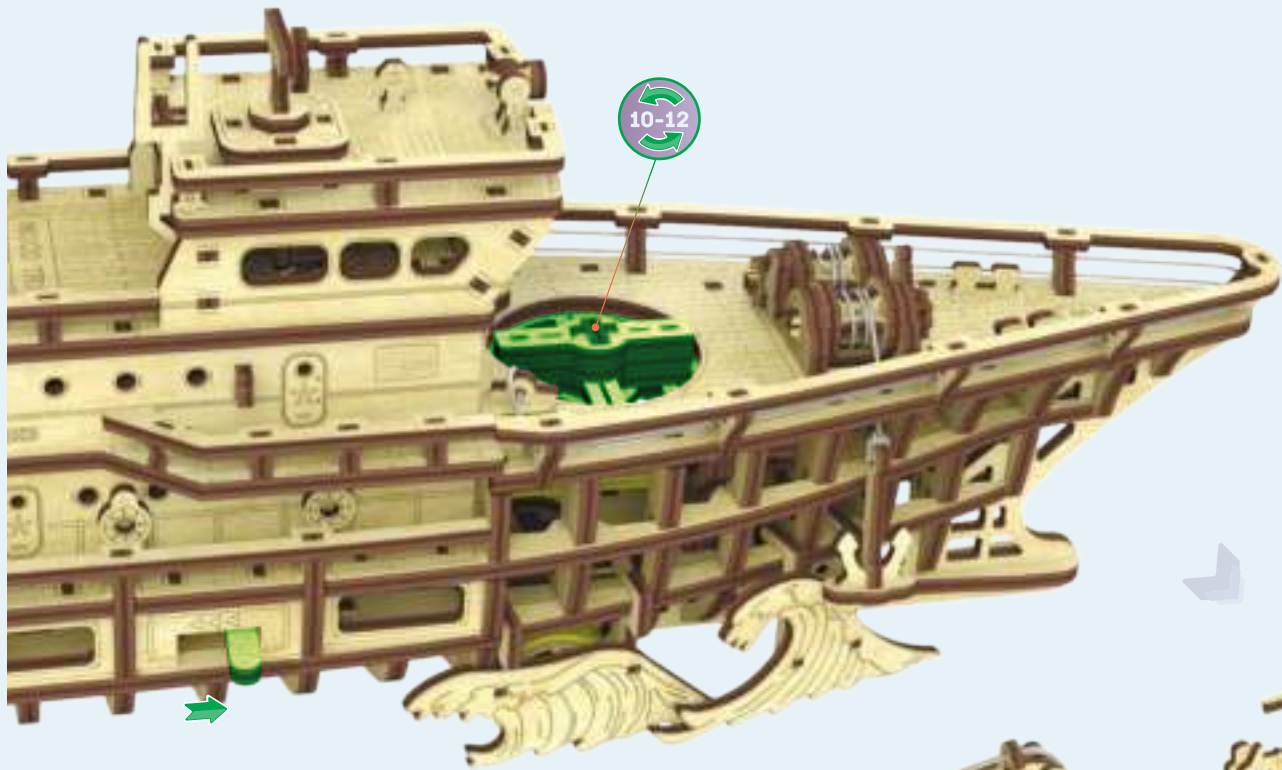

10-12

