

# WOOD TRICK

ELECTRIC  
SERIES

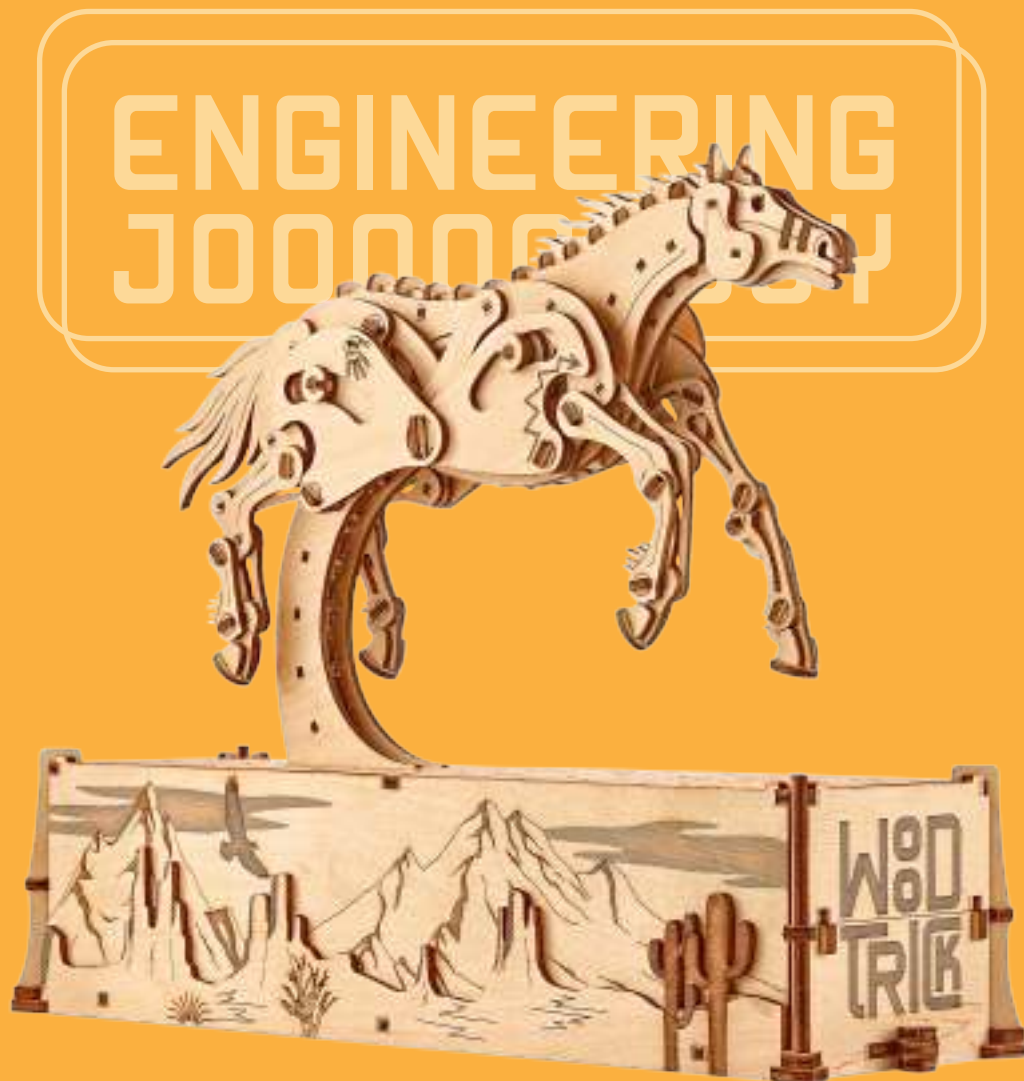

ENGINEERING  
JOJO

MECHANICAL MODELS & KITS

## MECHANICAL MUSTANG



5 LEVEL

628  
PIECES

WDTK090



**UKR** Не підпалювати! **ENG** Do not set fire to it! **DEU** Nicht anzünden! **FRA** Ne pas allumer!  
**POL** nie podpalaj! **SPA** No prender fuego! **ITA** Non dare fuoco!



**UKR** Обережно! Гострі деталі! **ENG** Caution! Sharp parts! **DEU** Vorsichtig! Scharfe Details!  
**FRA** Attention Détails tranchants! **POL** Uwaga! Ostre szczegóły! **SPA** Cuidado! Piezas cortantes! **ITA** Attenzione! Dettagli nitidi!

**UKR** Рекомендація: якщо виникли складнощі при скріпленні деталей, обробіть зубочистки парафіном. **ENG** Recommendation: if you have difficulty in connecting parts, treat toothpicks with paraffin. **DEU** Empfehlung: Wenn Sie Schwierigkeiten haben, Teile zu verbinden, behandeln Sie Zahnstocher mit Paraffin. **FRA** Recommandation: si vous avez des difficultés pièces de fixation, traitez les cure-dents avec de la paraffine. **POL** Zalecenie: jeśli masz trudności z połączeniem części, obsługiwać wykałaczki parafiną. **SPA** Recomendación: si tiene dificultades para fijar piezas, trate mondadientes con parafina. **ITA** Raccomandazione: in caso di difficoltà nel fissare le parti, trattare gli stuzzicadenti con paraffina.

**UKR** Конструктор не вимагає застосування клею. **ENG** The assembling of constructor does not require to use glue. **DEU** Für die Montage des Konstruktors ist kein Klebstoff erforderlich. **FRA** Aucune colle n'est nécessaire pour monter le constructeur. **POL** Montaż konstruktora odbywa się bez kleju. **SPA** El montaje constructor no requiere el uso de pegamento. **ITA** L'assemblaggio non richiede l'uso di colla.

**UKR** Крихкі деталі! Під час вилучення конструктора з карти будьте обережні! **ENG** Fragile details! Be careful when removing the constructor from the card! **DEU** Zerbrechliche Details! Seien Sie vorsichtig, wenn Sie den Konstruktor von der Karte entfernen! **FRA** Détails fragiles! Faites attention en retirant les éléments de la construction de la carte! **POL** Kruche szczegóły! Przedmioty należy wyjmować z karty ostrożnie! **SPA** Detalles frágiles! Sea prudente al sacar elementos de mecano del tarjeta! **ITA** Dettagli fragili! Gli elementi vanno estratti dalla scheda con cautela!

**UKR** Всі елементи, що входять у зачеплення необхідно зачистити наждачним папером і змастити парафіном. **ENG** All elements that interlock must be sanded with sandpaper and greased with paraffin. **DEU** Alle eingreifenden Teile müssen mit Sandpapier gereinigt und mit Paraffin eingefettet werden. **FRA** Il faut nettoyer tous les éléments de l'accrochage à l'aide du papier-meri et les traiter avec de la paraffine. **POL** Wszystkie zaczepione elementy należy oczyścić papierem ściernym i nasmarować parafiną. **SPA** Todos los elementos que se enganchan deben limpiarse con papel de lija y engrasarse con parafina. **ITA** Tutti gli elementi agganciati devono essere puliti con carta vetrata e ingrassati con paraffina.

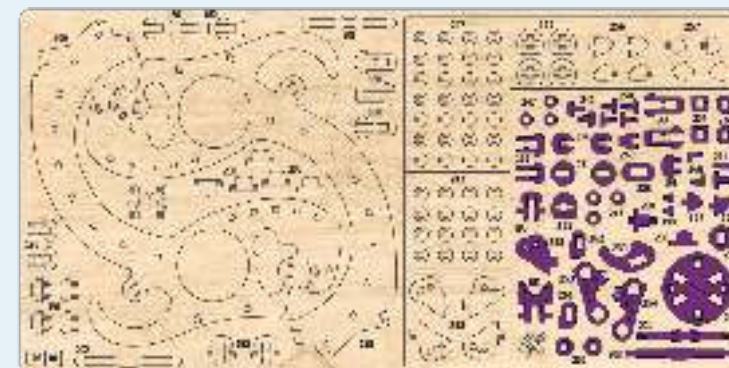
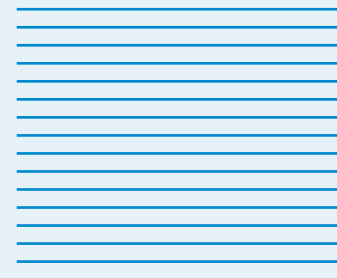

**UKR** Запасні деталі. **ENG** Spare parts. **DEU** Ersatzteile. **FRA** Pièces de rechange. **POL** Części zamienne. **SPA** Repuestos. **ITA** Pezzi di ricambio.

10

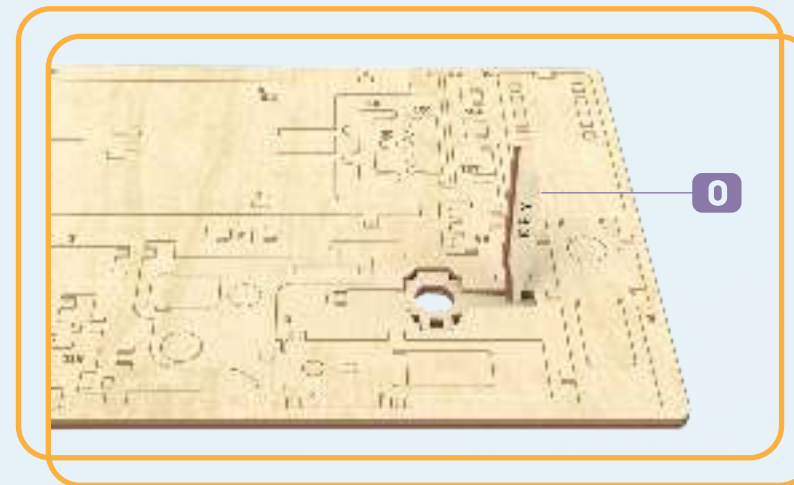

9

**UKR** Допоміжний інструмент для збірки або вимірювання відстаней. **ENG** Auxiliary tool for assembling or measuring distances. **DEU** Hilfswerkzeug zum Montieren oder Messen von Abständen. **FRA** Outil auxiliaire pour assembler ou mesurer des distances. **POL** Narzędzie pomocnicze do montażu lub pomiaru odległości. **SPA** Herramienta auxiliar para ensamblar o medir distancias. **ITA** Strumento ausiliario per l'assemblaggio o la misurazione delle distanze.



**UKR** Звернути увагу! **ENG** Note! **DEU** Aufgepasst! **FRA** Faites attention! **POL** Uwaga! **SPA** ¡Presta atención! **ITA** Presta attenzione!



**UKR** Резинка. **ENG** Rubber band. **DEU** Gummiband. **FRA** Bande élastique. **POL** Gumka. **SPA** Goma. **ITA** Elastico.

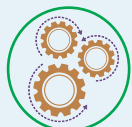

**UKR** Після складання, механізм потрібно розробити. **ENG** After being assembled, the mechanism should be activated. **DEU** Nach der Montage sollte der Mechanismus ausgearbeitet werden. **FRA** Après l'assemblage, le mécanisme doit être travaillé. **POL** Po montażu mechanizm należy rozpracować. **SPA** Hace falta poner en operación el mecanismo después de su montaje. **ITA** Dopo l'assemblaggio, il meccanismo deve essere sviluppato.



**UKR** Видалити задирки. **ENG** Remove burrs. **DEU** Niednägel entfernen. **FRA** Enlever les bavures. **POL** Usuń zadziory. **SPA** Quitar rebabas. **ITA** Eliminare le bave.



**UKR** Змастити парафіном. **ENG** Lubricate with paraffin. **DEU** Mit dem Paraffin schmieren. **FRA** Lubrifier à la paraffine. **POL** Nasmaruj parafiną. **SPA** Lubricar con parafina. **ITA** Lubrificare con paraffina.



**UKR** Конструктор може в деяких місцях туго з'єднатися, для того, щоб зібрана модель мала міцність та надійність. Для більш зручної збірки конструктора, рекомендуємо використовувати плоскогубці та канцелярський ніж. **ENG** Design kit can be tightly connected in some places, so that the assembled model has solidity and reliability. We recommend using pliers and box cutter for a more convenient design kit assembly. **DEU** Der Konstruktor kann an einigen Stellen keine gute Verbindung herstellen, so daß das zusammengebaute Modell eine ausreichende Festigkeit und Zuverlässigkeit aufweist. Für eine bequemere Montage des Konstrukteurs empfehlen wir die Verwendung einer Zange und eines Schreibwarenmessers. **FRA** Le jeu de construction peut être étroitement connecté à certains endroits, pour que le modèle assemblé soit solide et fiable. Pour un assemblage plus pratique de jeu de construction, nous vous recommandons d'utiliser une pince et un couteau à papeterie. **ITA** Le jeu de construction peut être étroitement connecté à certains endroits, pour que le modèle assemblé soit solide et fiable. Pour un assemblage plus pratique de jeu de construction, nous vous recommandons d'utiliser une pince et un couteau à papeterie. **SPA** Le jeu de construction peut être étroitement connecté à certains endroits, pour que le modèle assemblé soit solide et fiable. Pour un assemblage plus pratique de jeu de construction, nous vous recommandons d'utiliser une pince et un couteau à papeterie. **POL** Le jeu de construction peut être étroitement connecté à certains endroits, pour que le modèle assemblé soit solide et fiable. Pour un assemblage plus pratique de jeu de construction, nous vous recommandons d'utiliser une pince et un couteau à papeterie.

**UKR** Увага! Для коректної роботи даної моделі, необхідно при збірці ретельно зачищати, змащувати парафіном усі деталі, які труться. Усі механізми повинні вільно обертатися. **ENG** Warning! For the correct operation of this model, it is necessary to clean carefully and to lubricate all rubbing parts with paraffin during assembly. All mechanisms must rotate freely. **FRA** Attention ! Pour le bon fonctionnement de ce modèle, il est nécessaire lors du montage de nettoyer et lubrifier soigneusement toutes les pièces à friction avec de la paraffine. Tous les mécanismes doivent tourner librement. **SPA** ¡Atención! Para el funcionamiento adecuado de este modelo a la hora de ensamblaje se recomienda alisar y lubricar cuidadosamente con parafina todos los detalles frotantes. Todos los mecanismos deben girar libremente. **ITA** Attenzione! Per il corretto funzionamento di questo modello, durante il montaggio, è necessario pulire e lubrificare accuratamente tutte le parti di sfregamento con paraffina. Tutti i meccanismi devono ruotare liberamente. **DEU** Hinweis! Für einen korrekten Betrieb dieses Modells ist bei dem Zusammenbau erforderlich, alle Reibteile sorgfältig auszuschrubben und mit Paraffin zu schmieren. Alle Bauteile sollen sich frei drehen. **POL** Uwaga! Aby ten model działał prawidłowo, podczas montażu wszystkie detale trące muszą być dokładnie oczyszczone i nasmarowane parafiną. Wszystkie mechanizmy muszą się swobodnie obracać.

A

- UA Кнопка
- EN Button
- DE Starttaste
- FR Le Bouton
- IT Il Pulsante
- SP El Botón
- PL Przycisk
- JP ボタン



B

- UA Мотор
- EN An engine
- DE Motor
- FR Le moteur
- IT Motore
- SP Motor
- PL Silnika
- JP モーター



C

- UA Батарейний відсік на 4 батарейки AA
- EN Battery compartment for 4 AA batteries
- DE Batteriefach für 4 AA-Batterien
- FR Baie pour 4 piles AA
- IT Compartimento de pilas para 4 pilas AA
- SP Unidad a batteria per 4 batterie AA
- PL Komora baterii na 4 baterie AA
- JP 単三電池4本用の電池コンパートメント



D

- UA Пружина
- EN Spring
- DE Frühling
- FR Printemps
- IT Primavera
- SP Primavera
- PL Wiosna
- JP 春



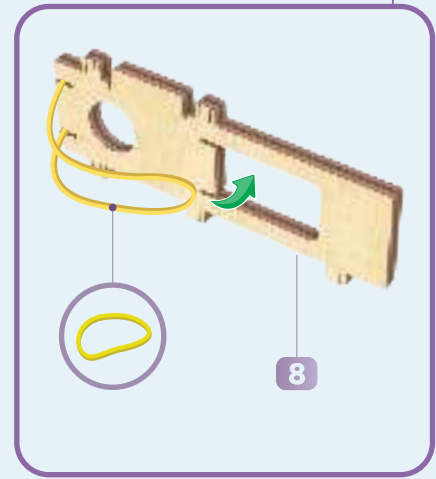
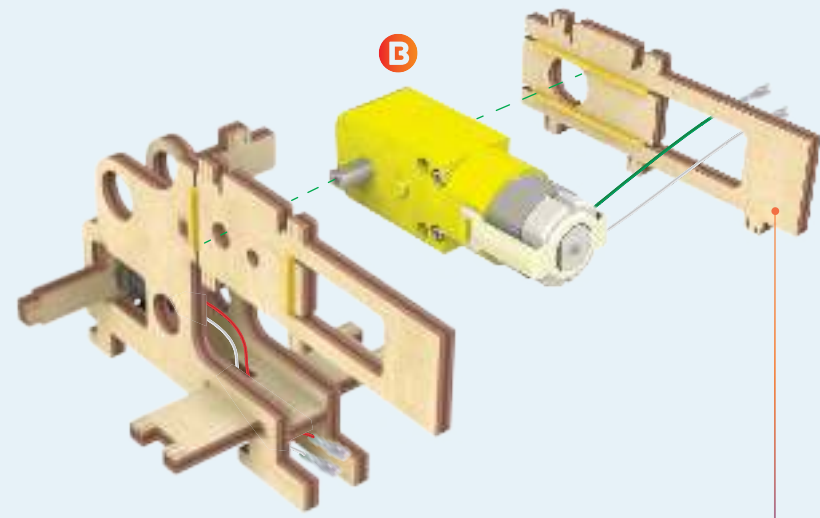
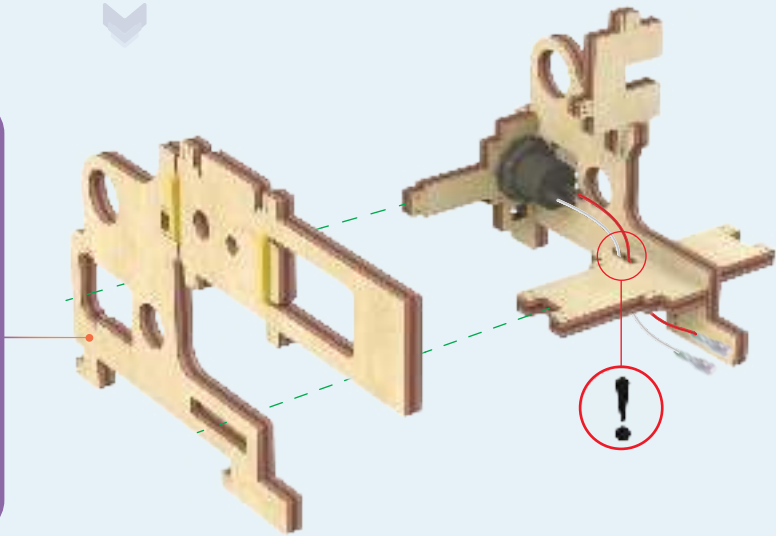
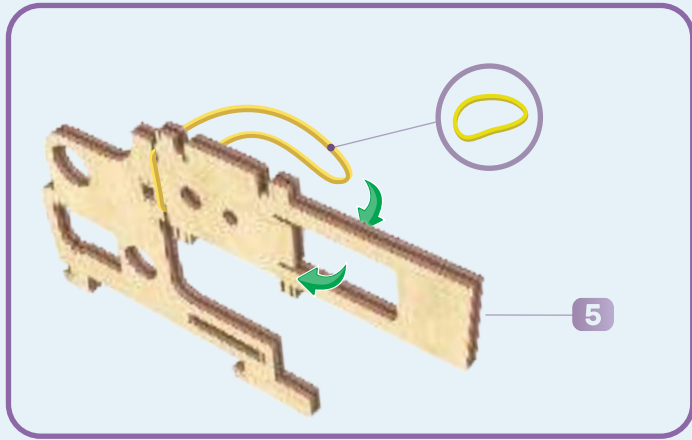
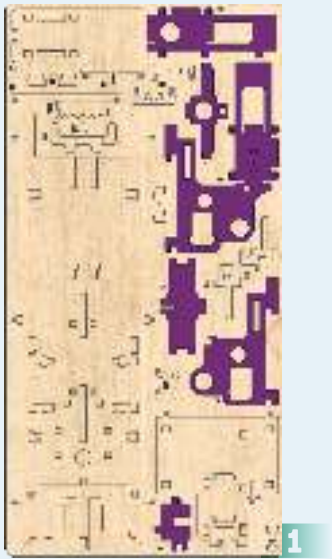
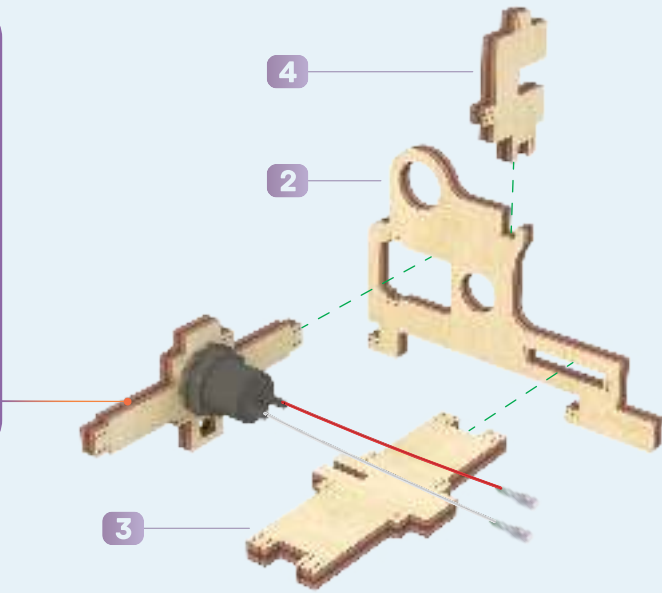
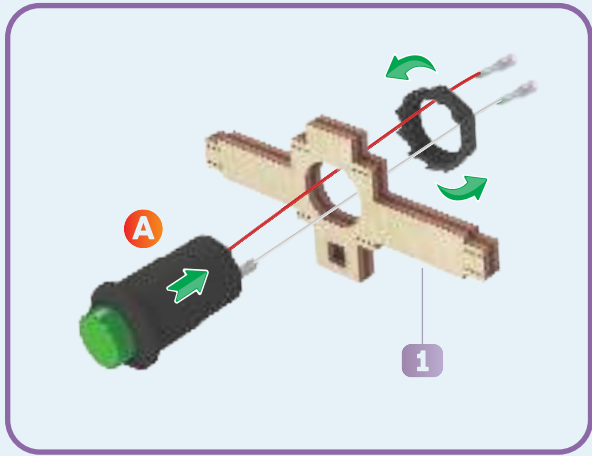

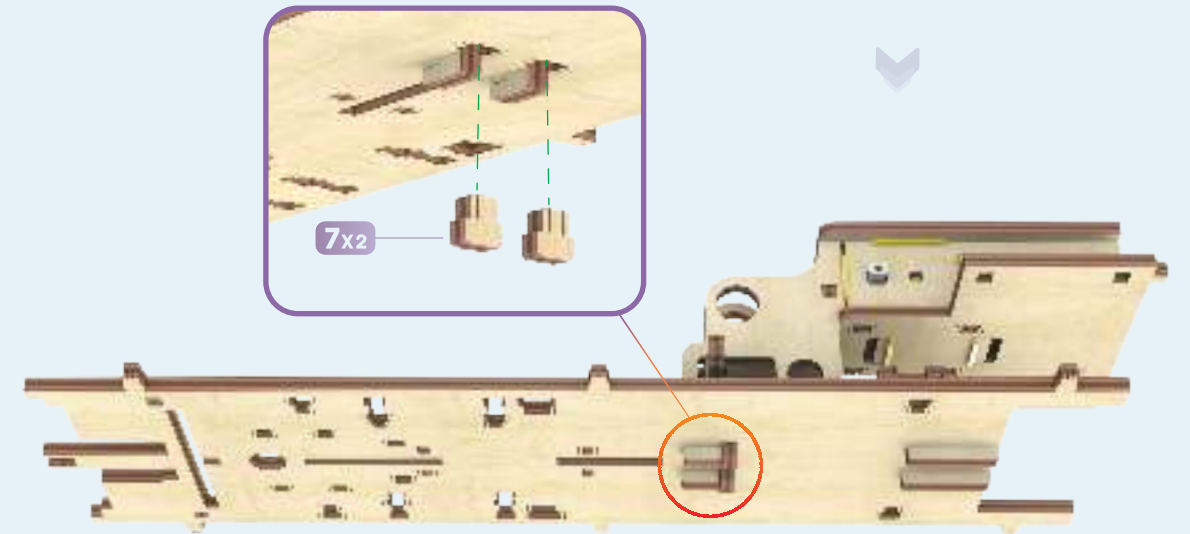
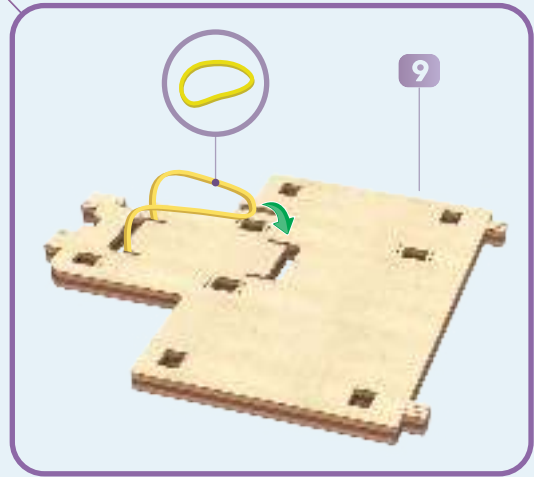
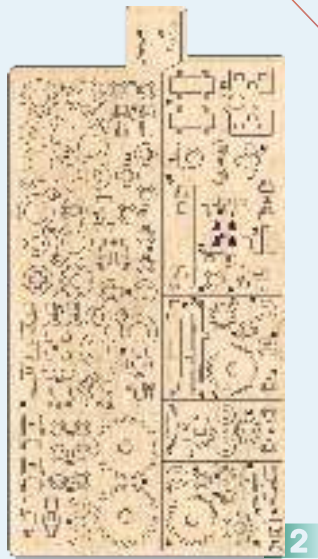
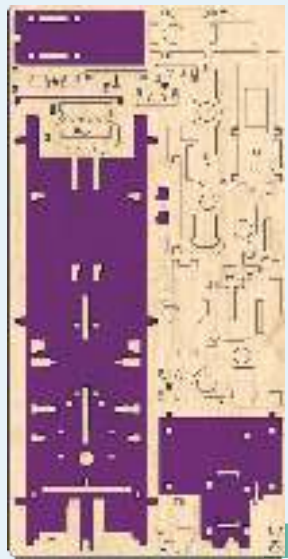
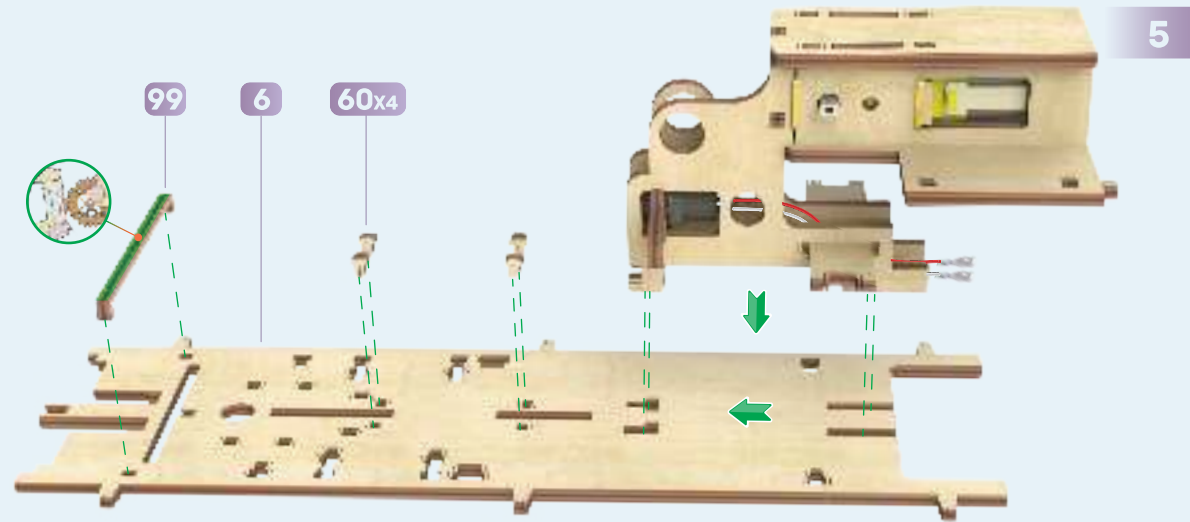
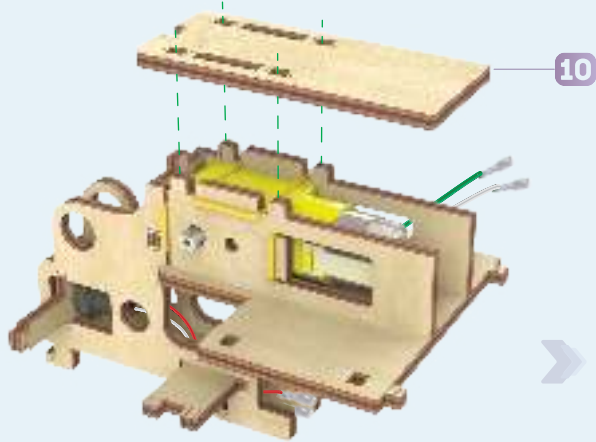
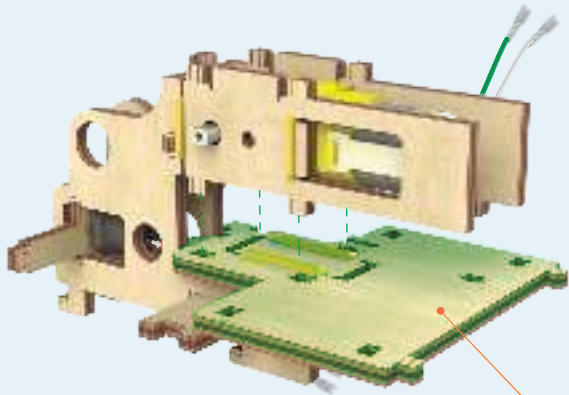

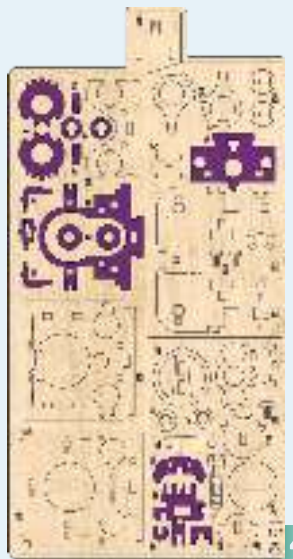

4

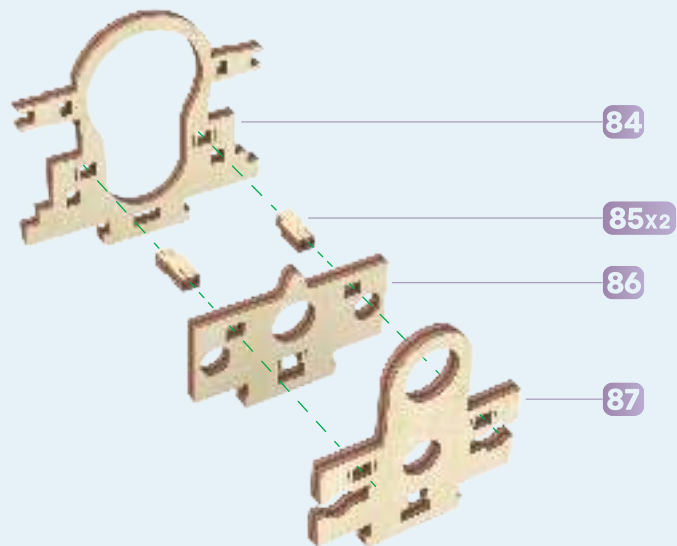

84

85x2

86

87

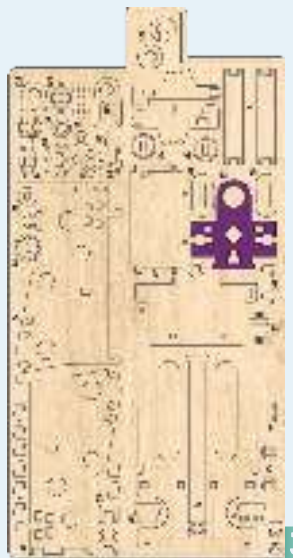

3

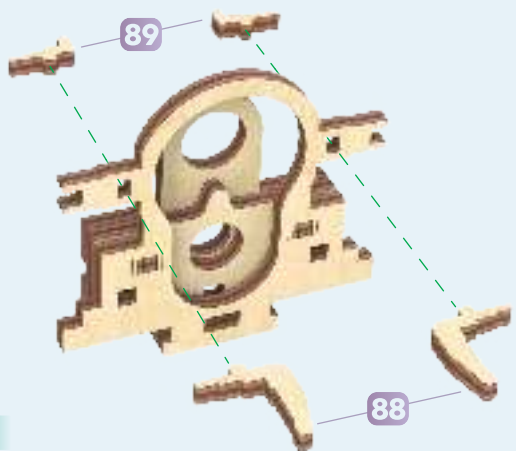

89

88

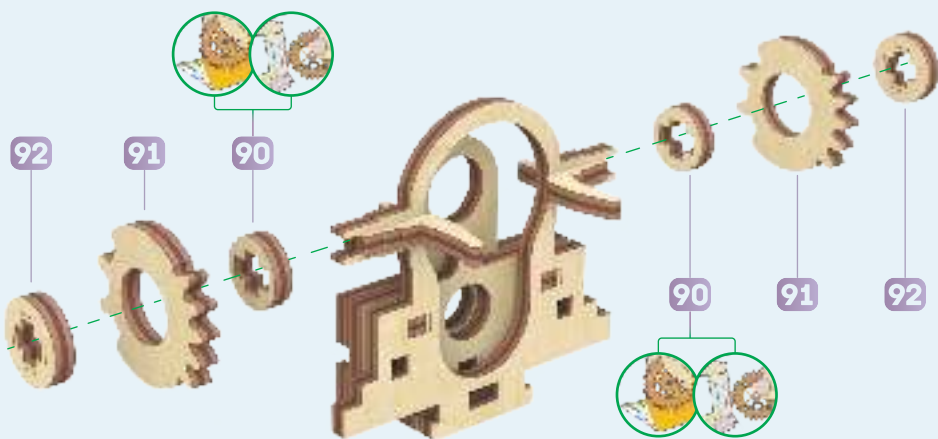

92

91

90

90

91

92

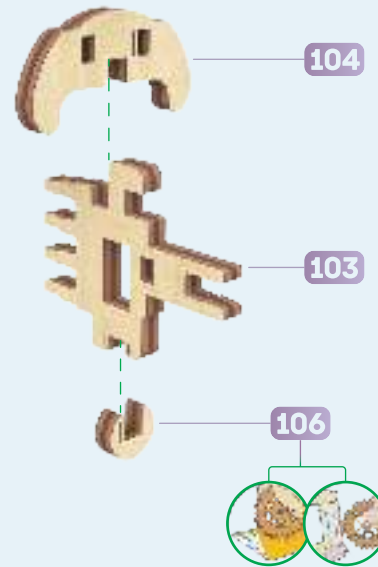

104

103

106

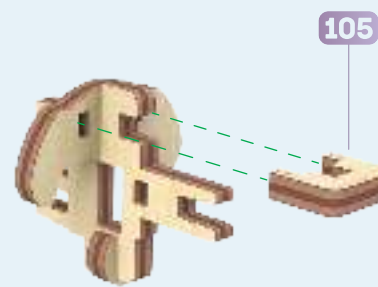

105

6

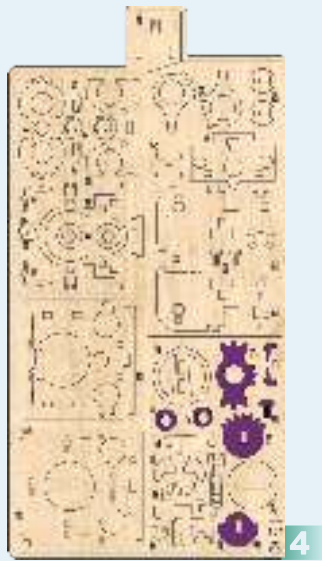
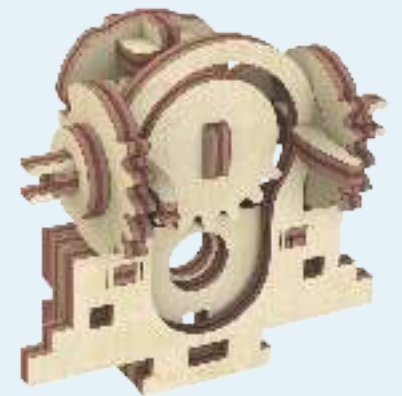
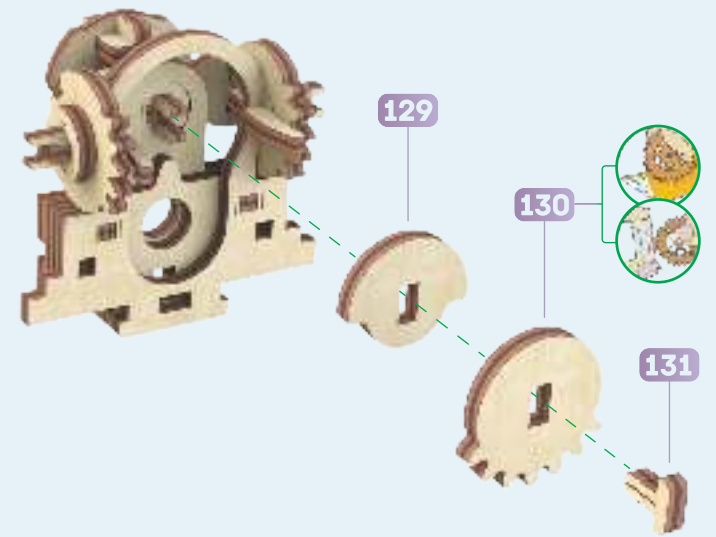
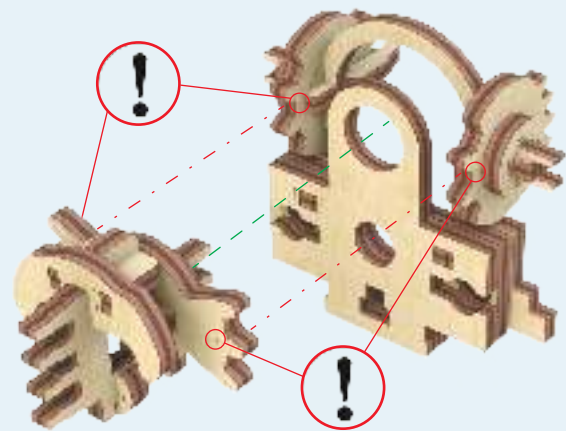
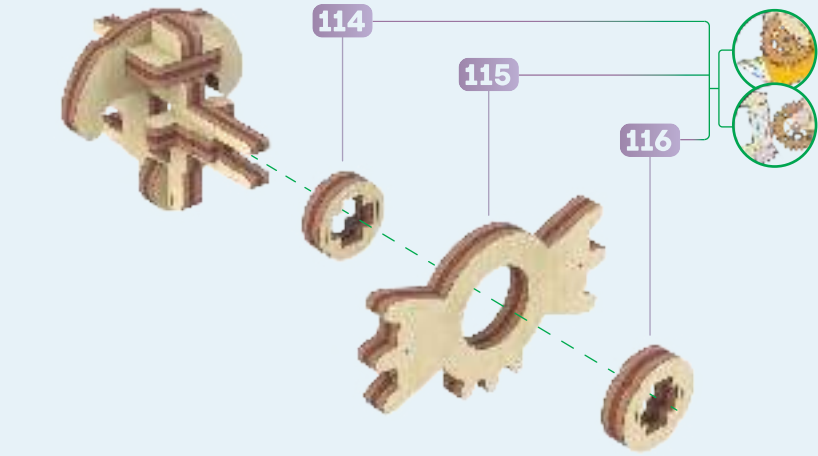
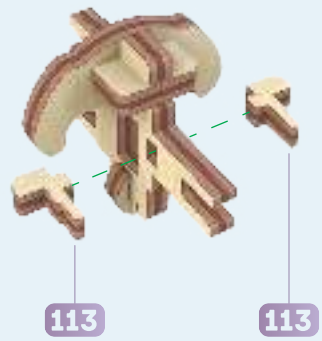



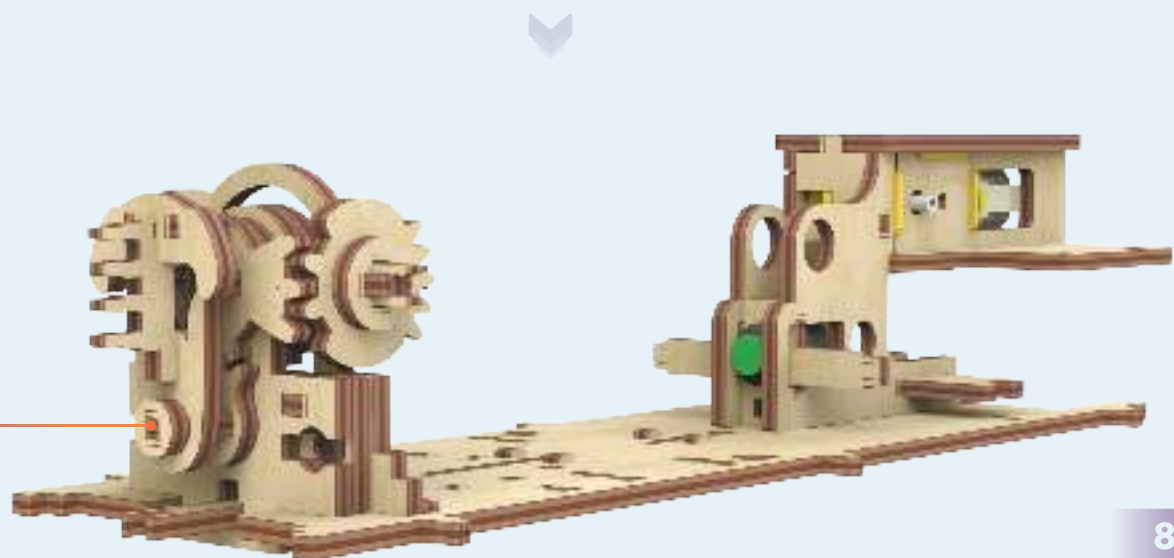
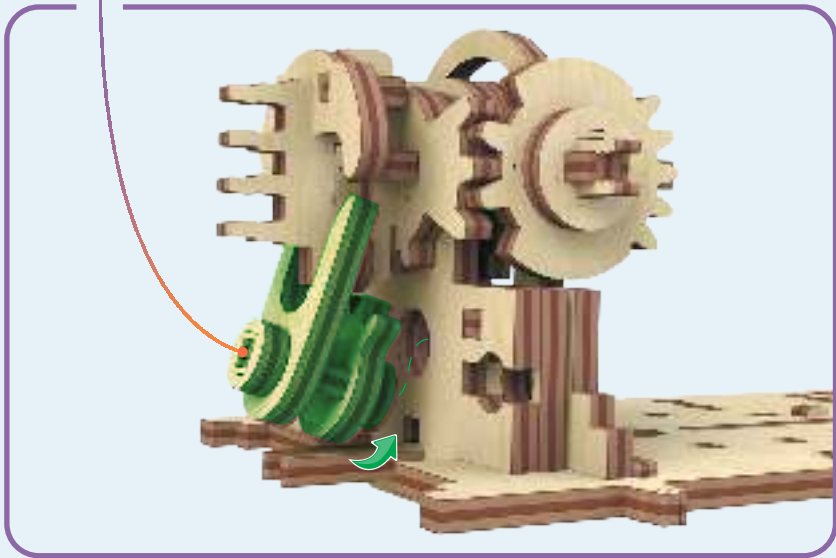
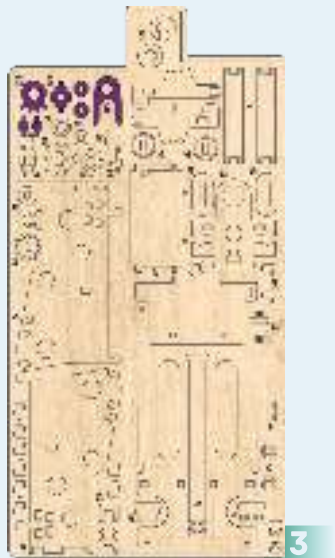
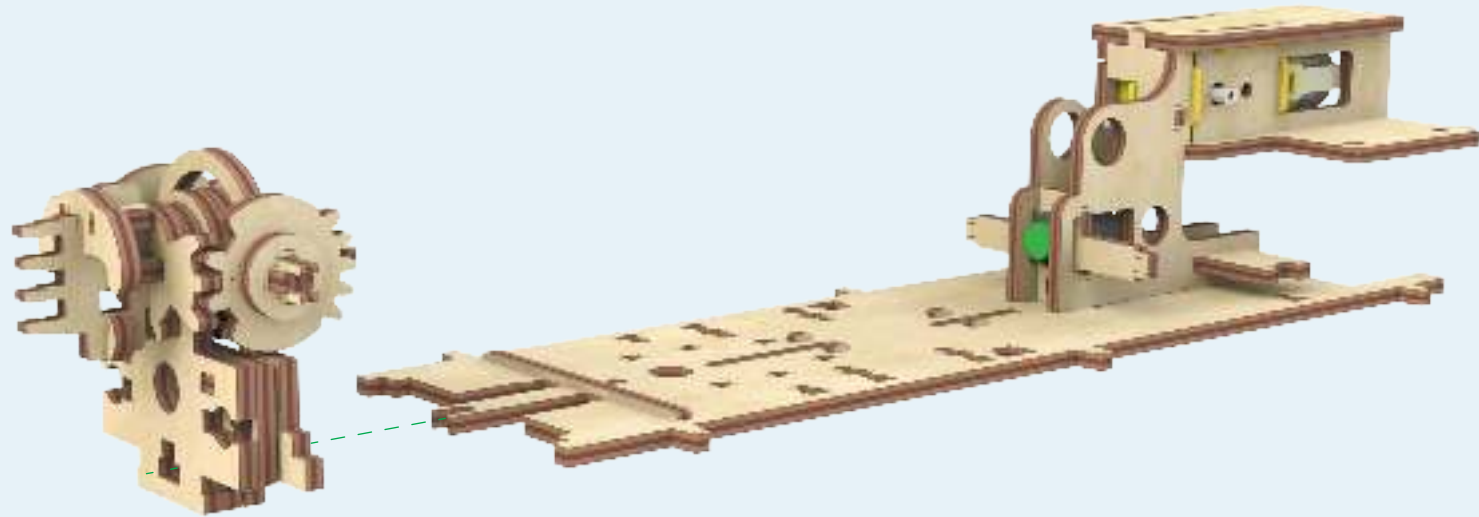
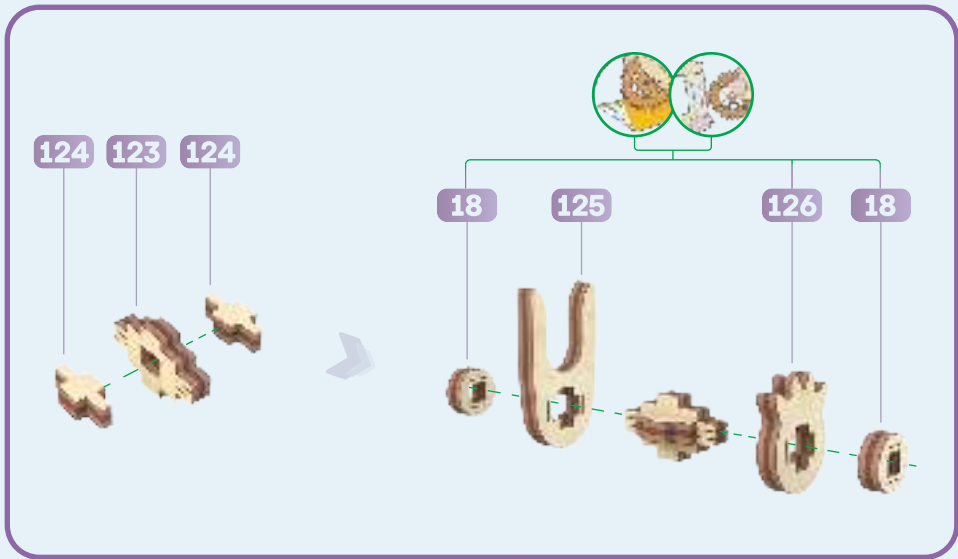

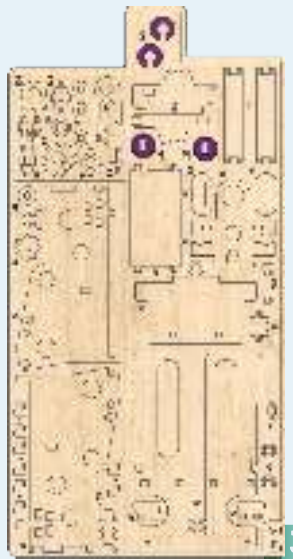

3

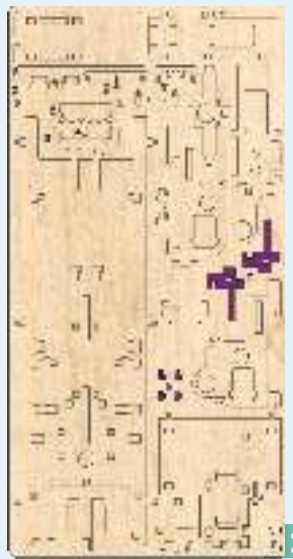
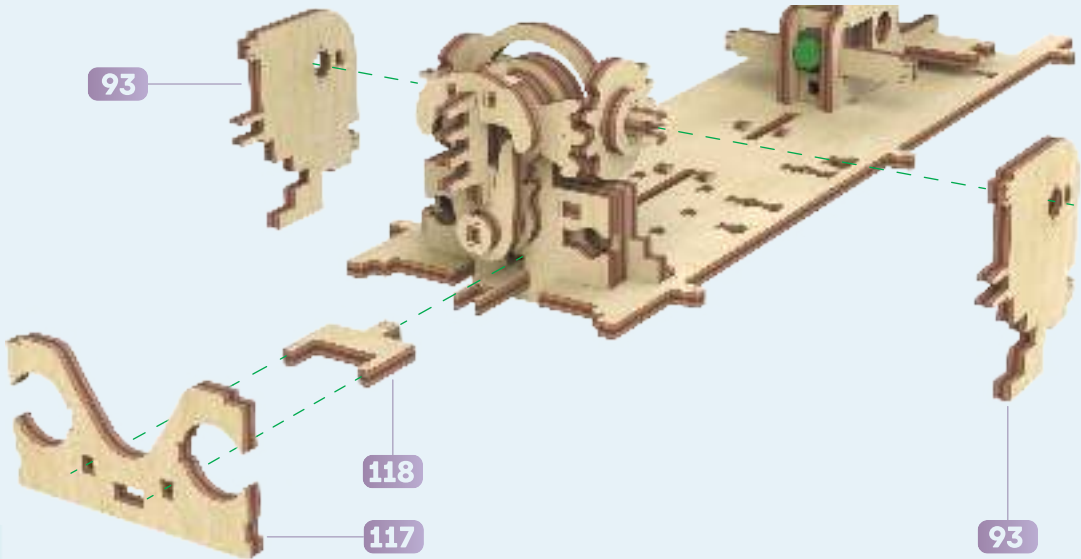

1

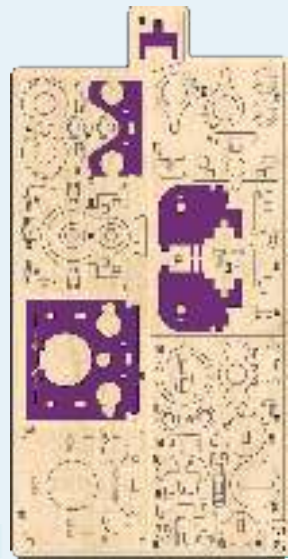

4

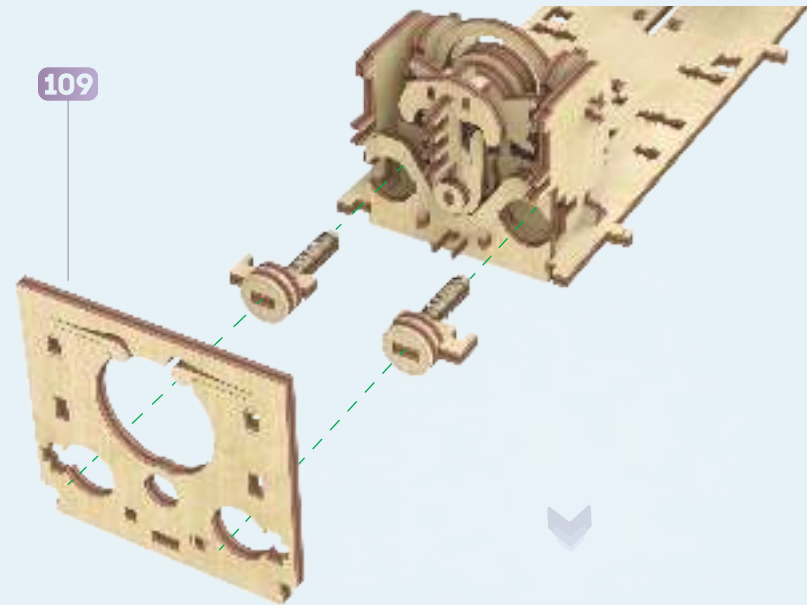
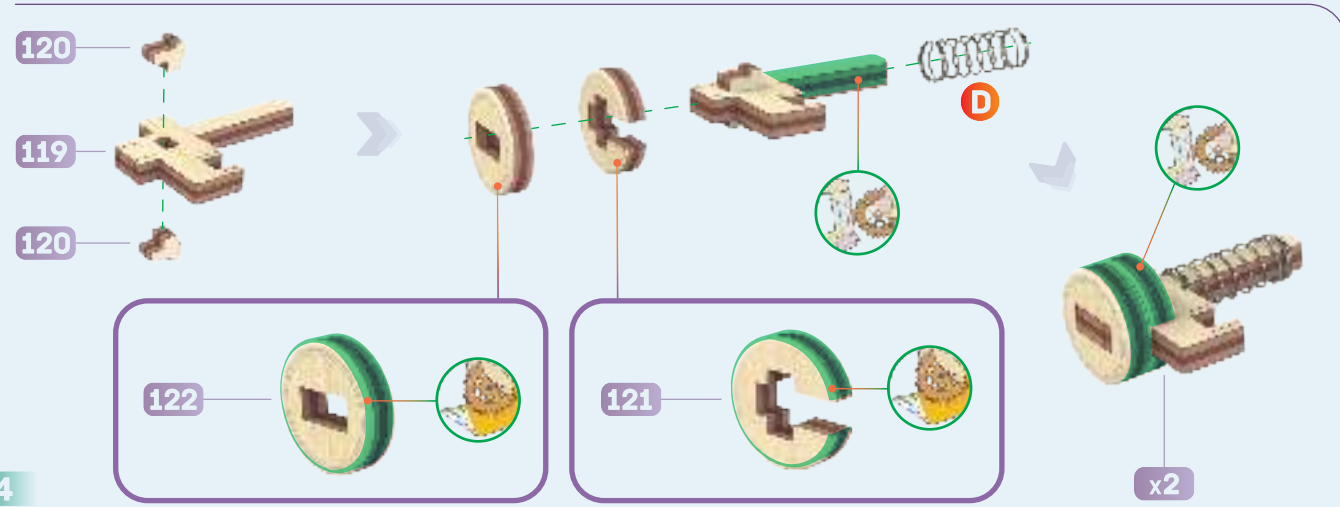

109



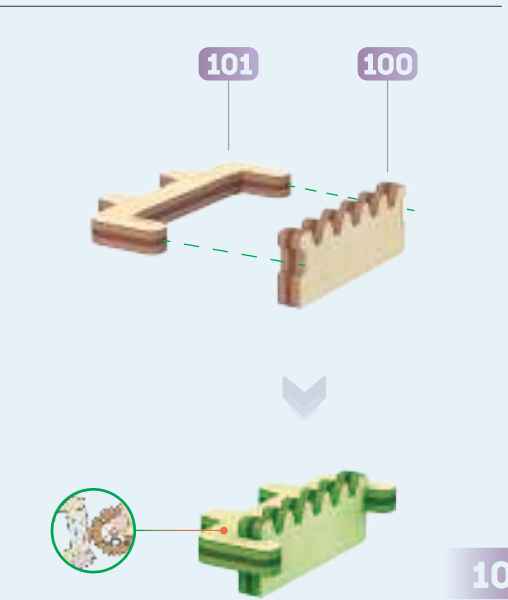
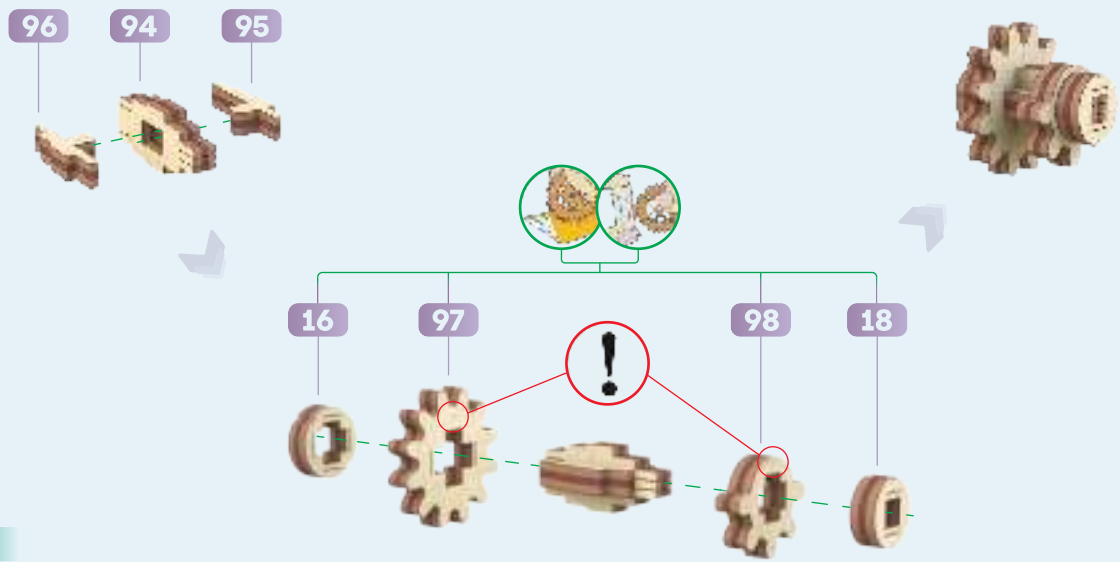
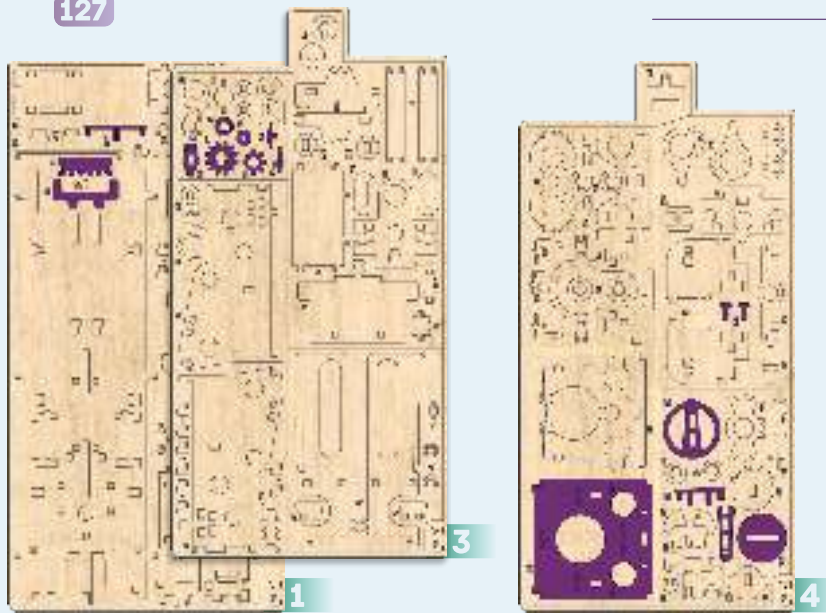
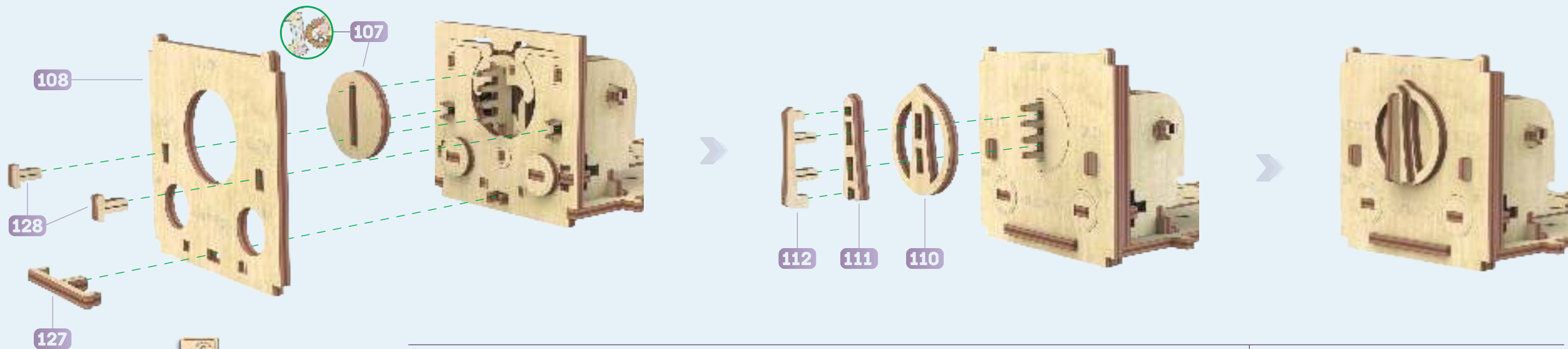

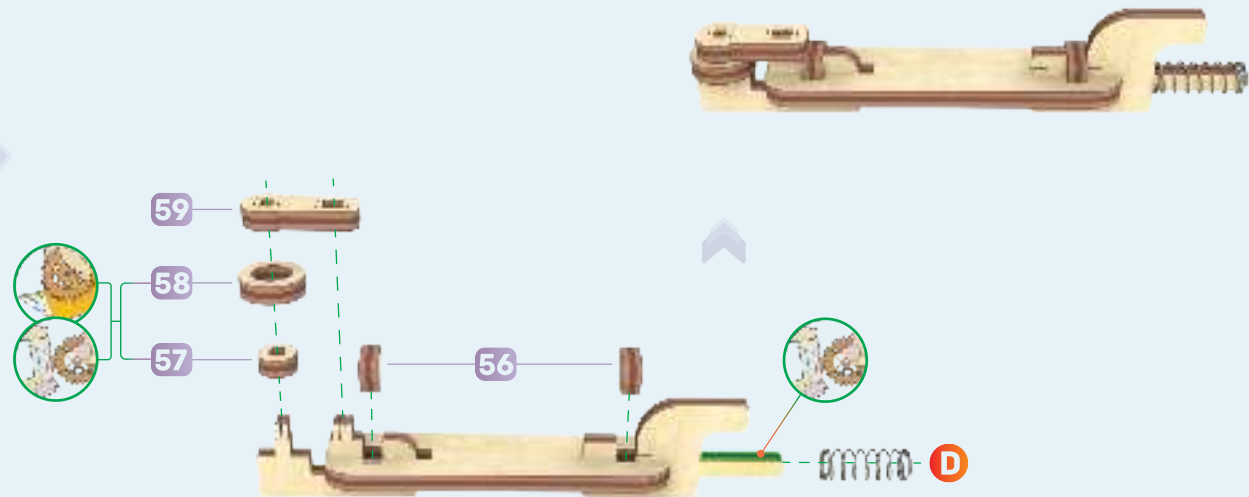
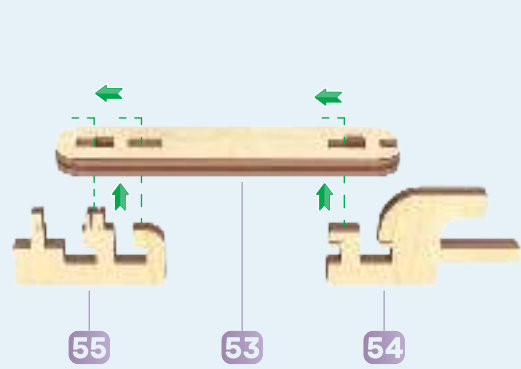
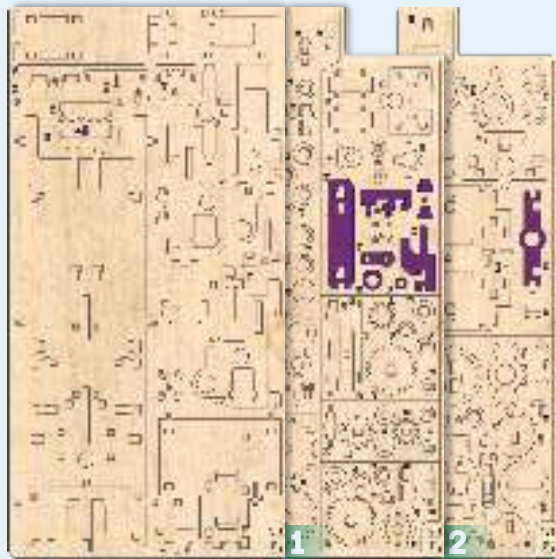
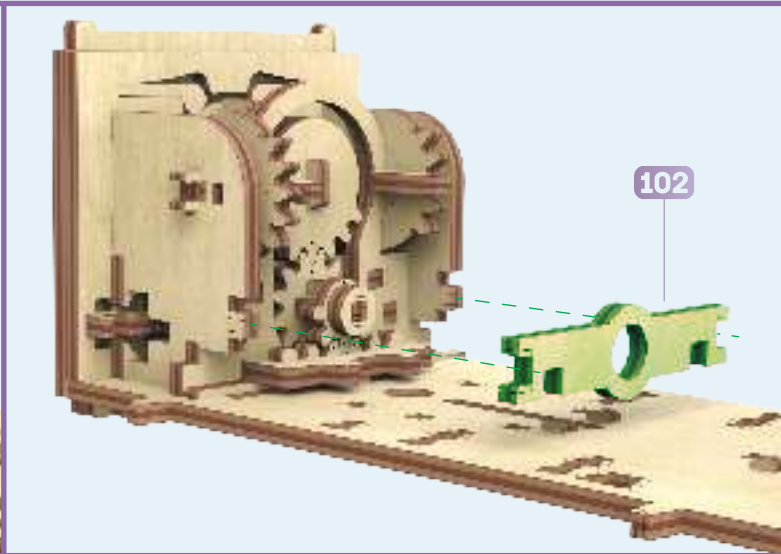
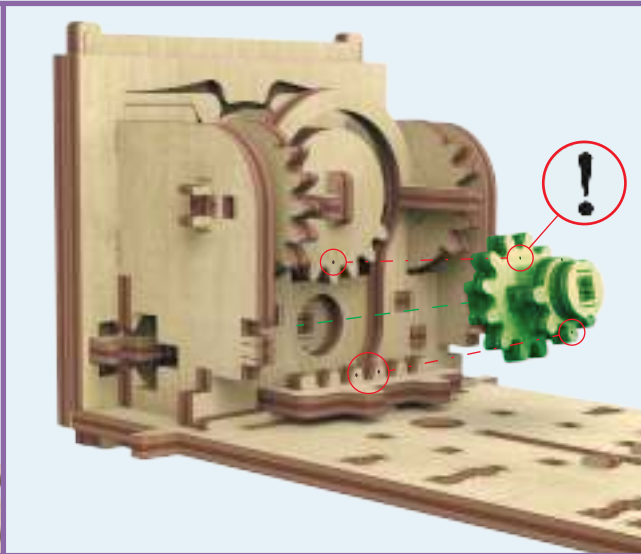
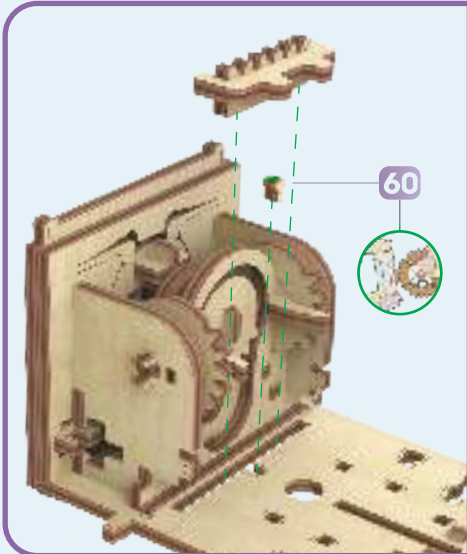

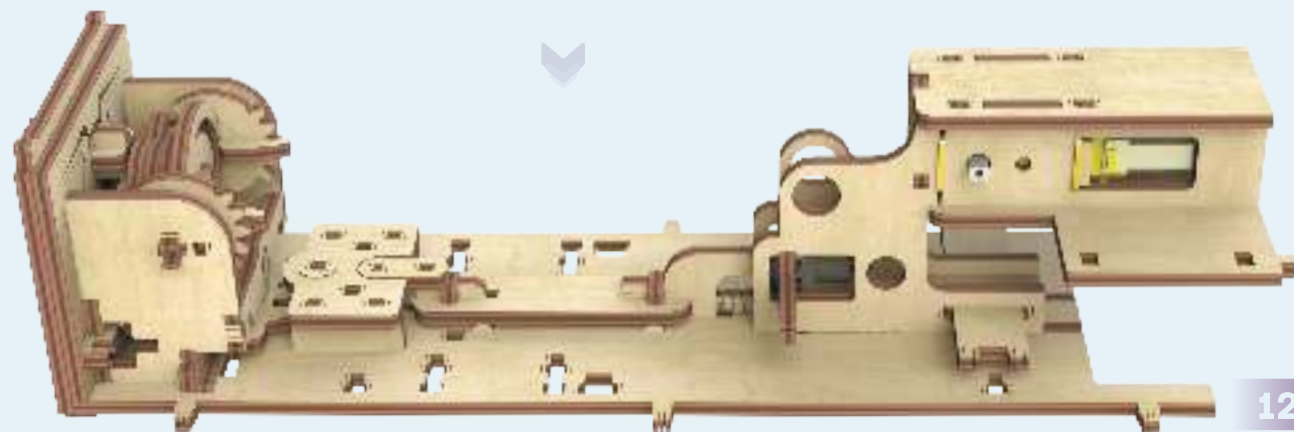
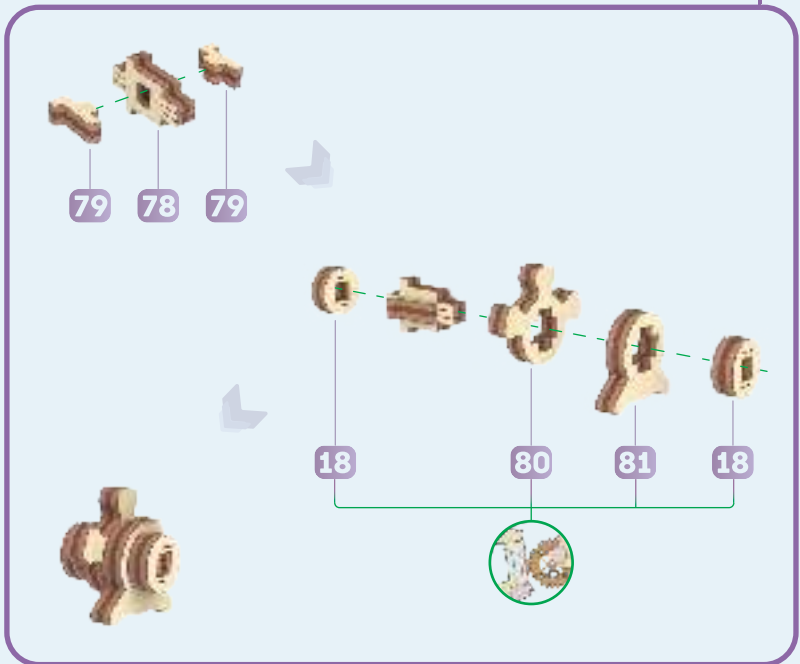
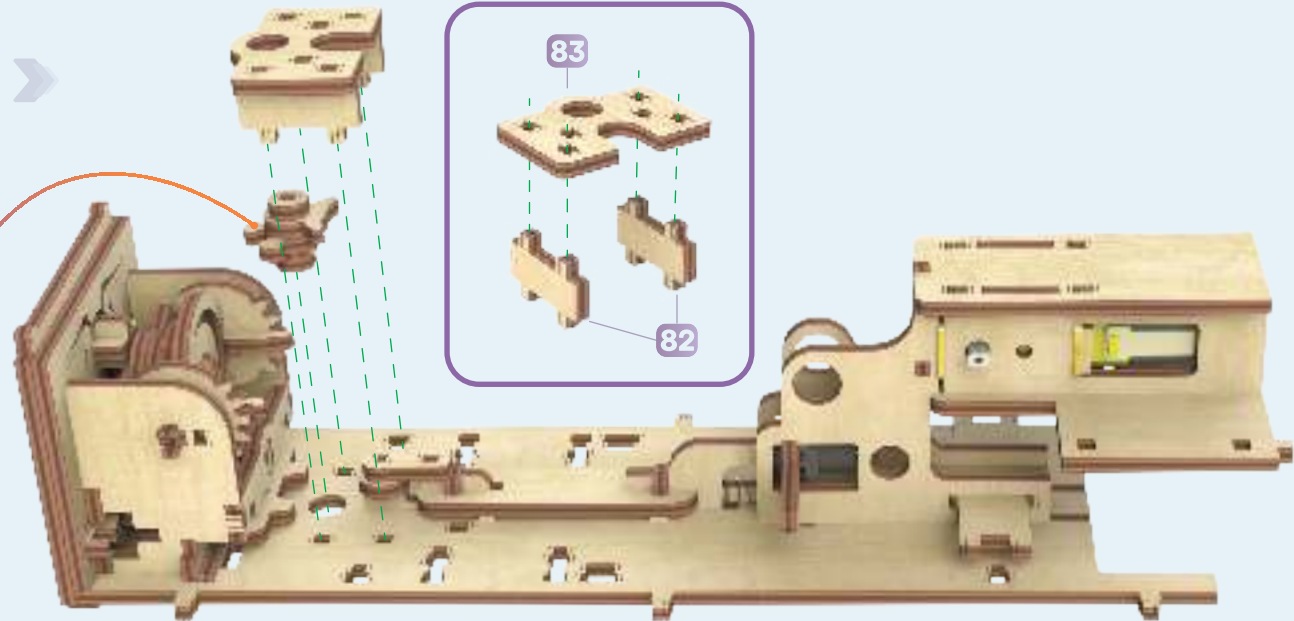
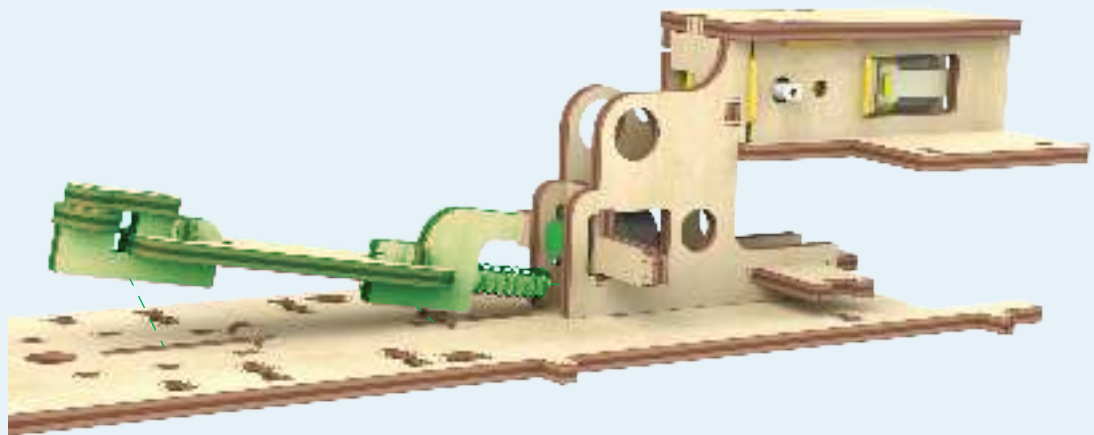

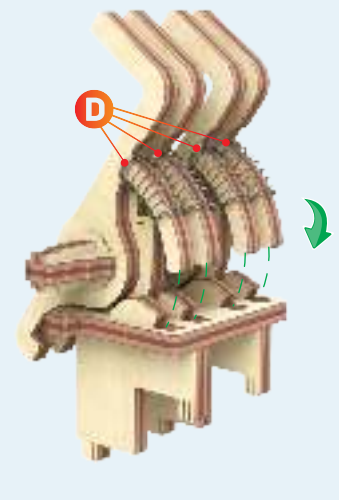
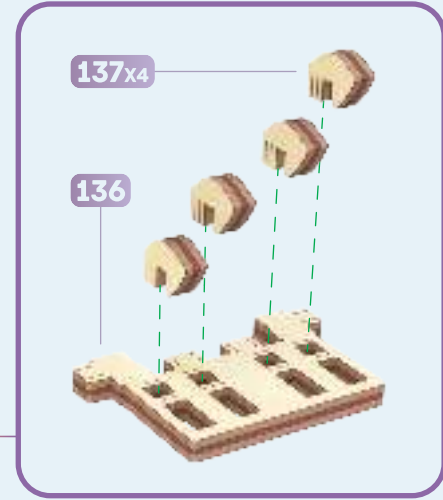
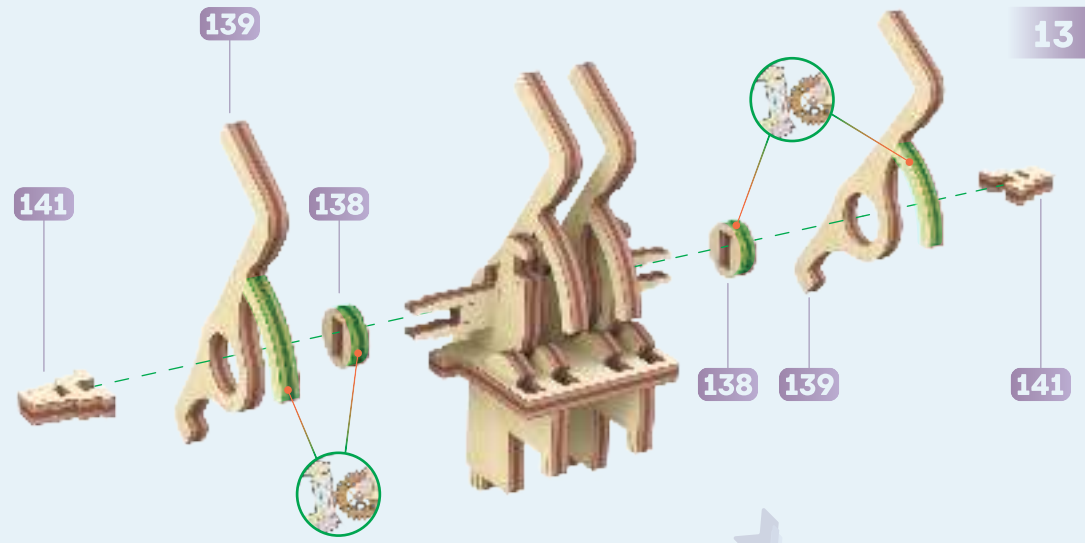
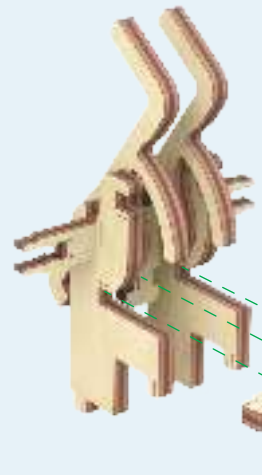
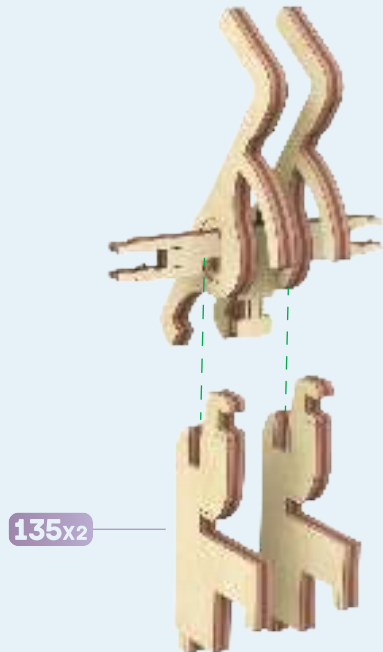
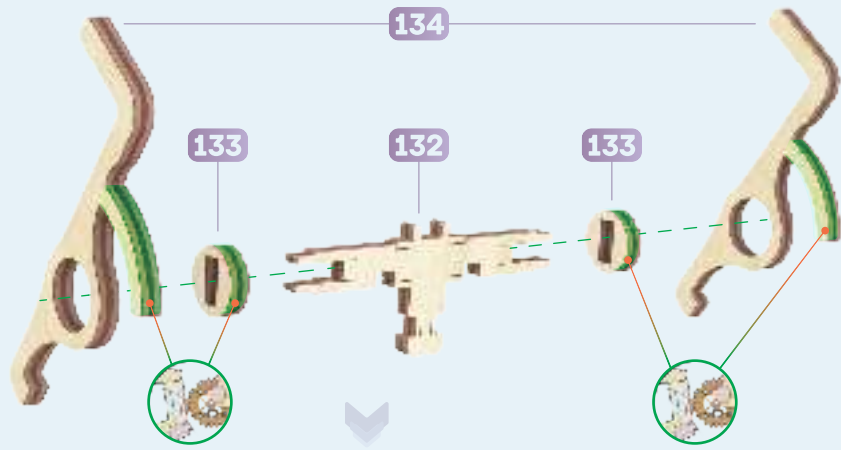
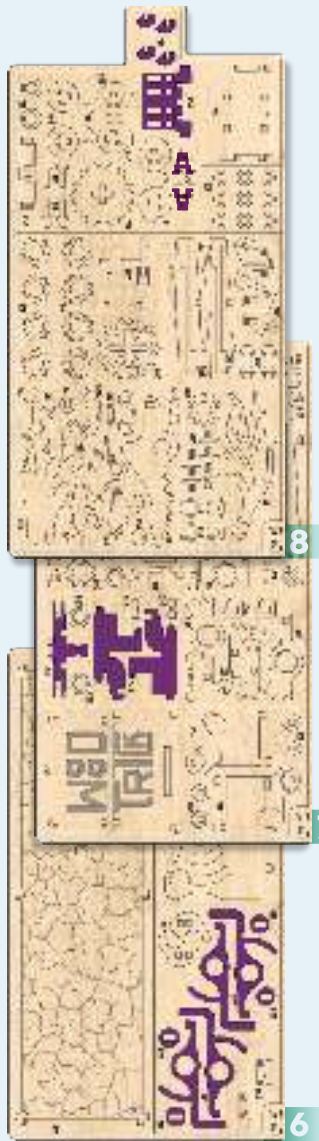

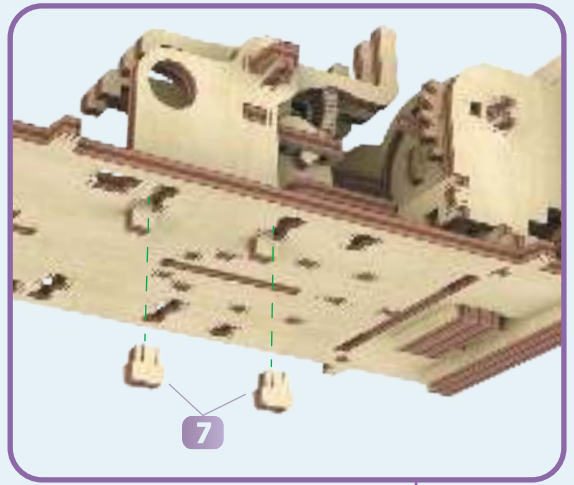
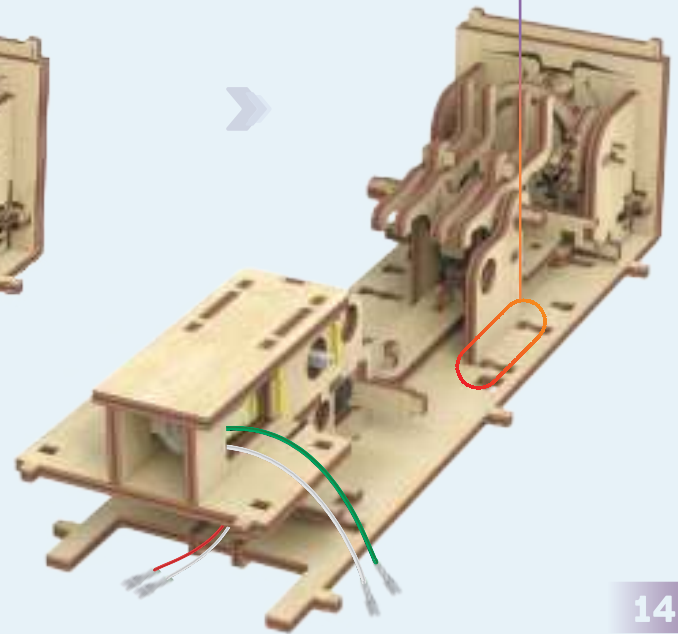
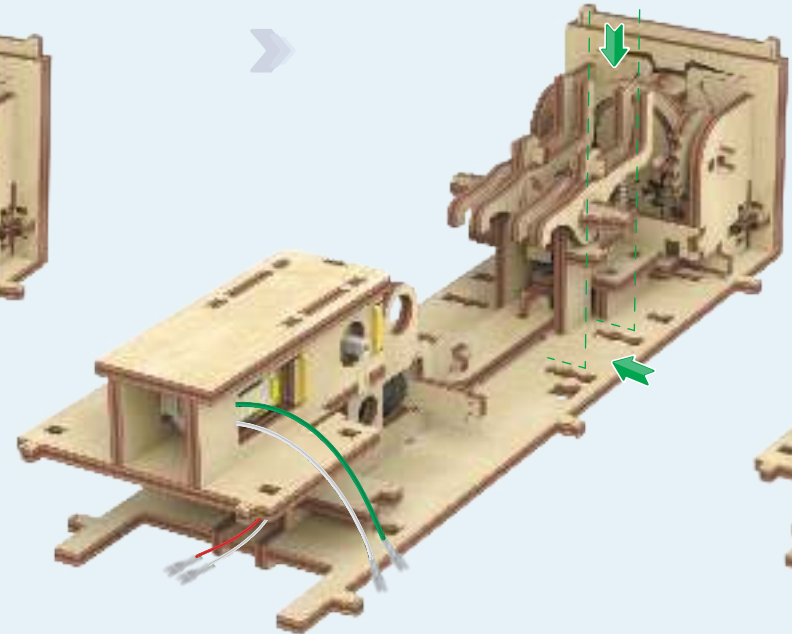
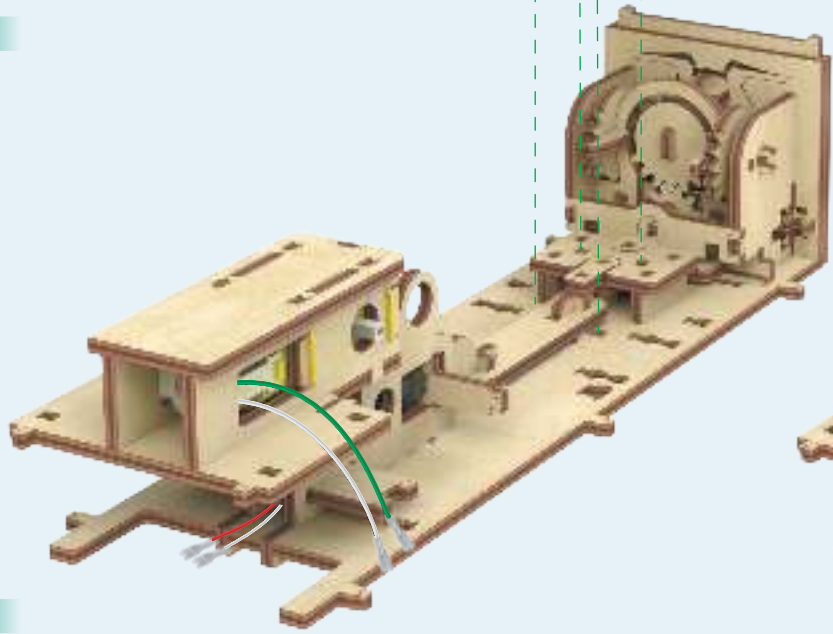
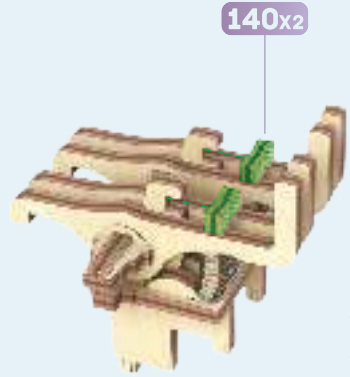
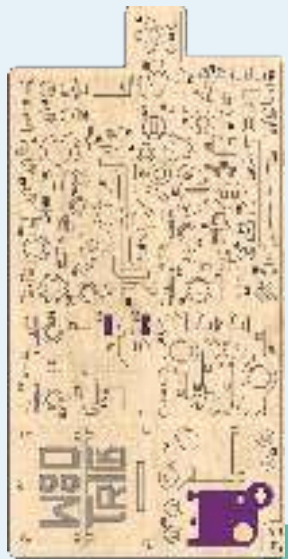

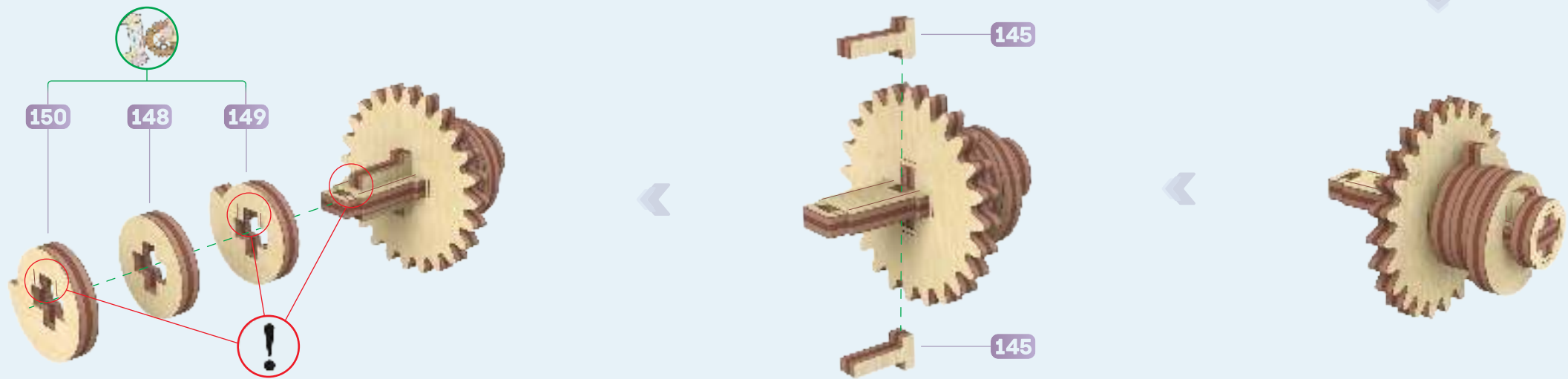
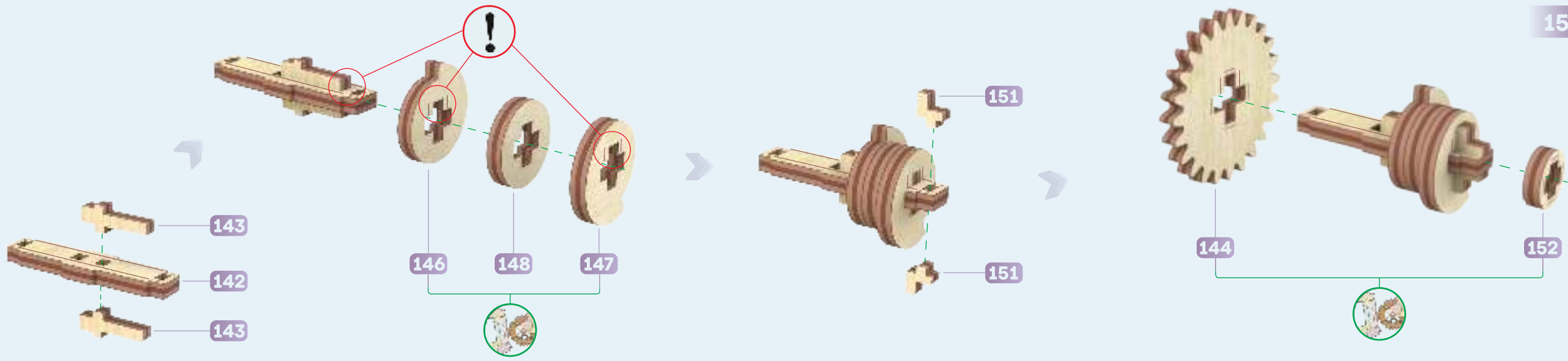



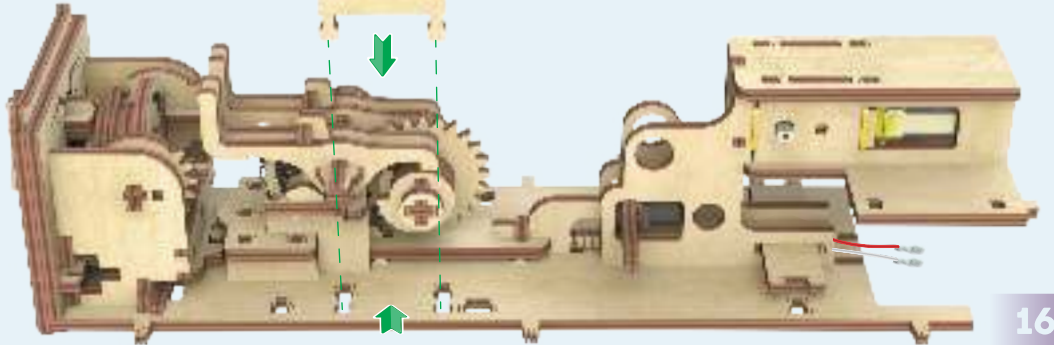
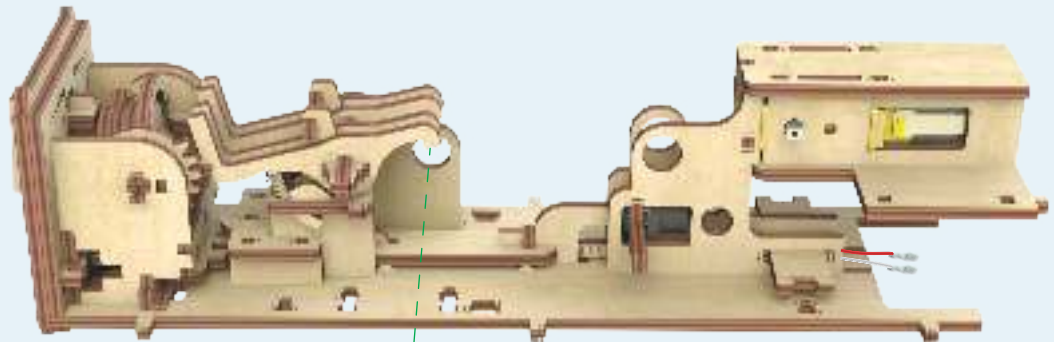
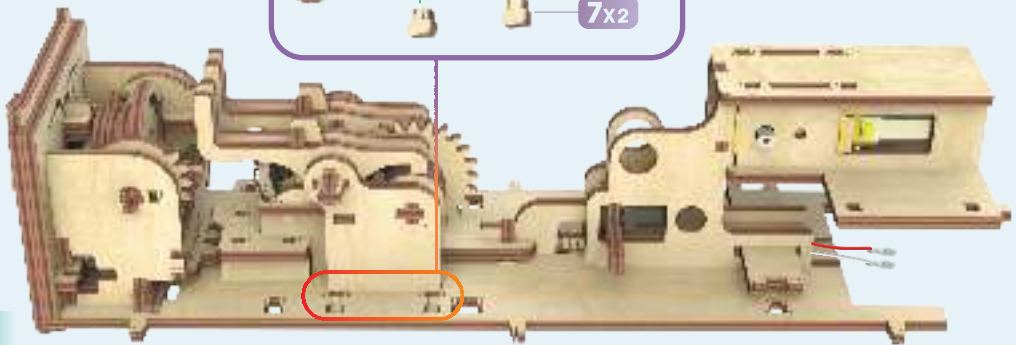
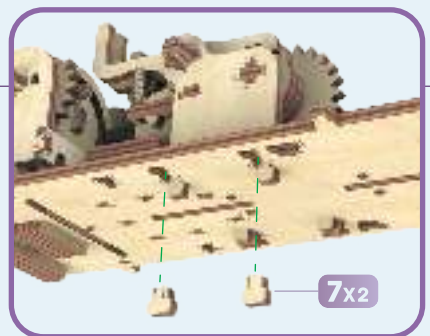

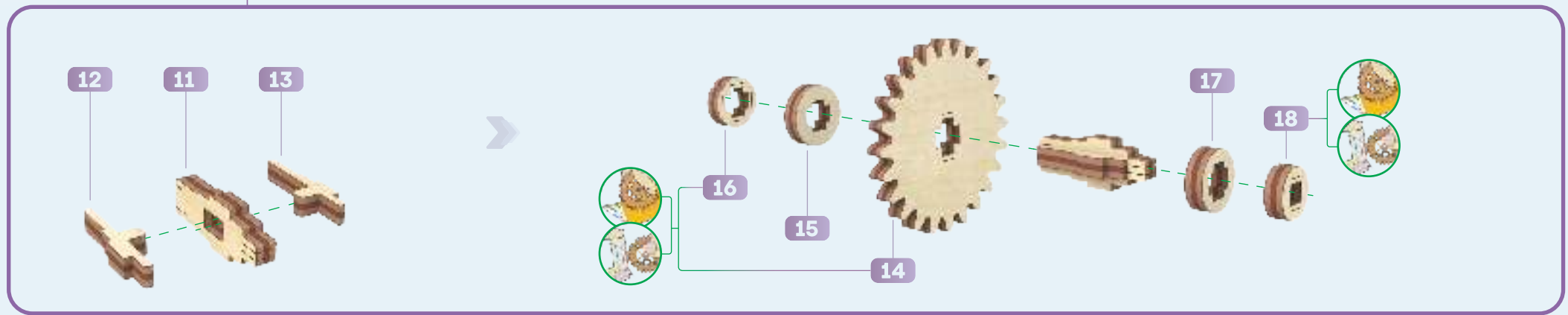
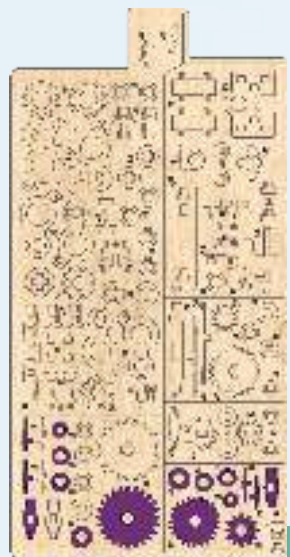
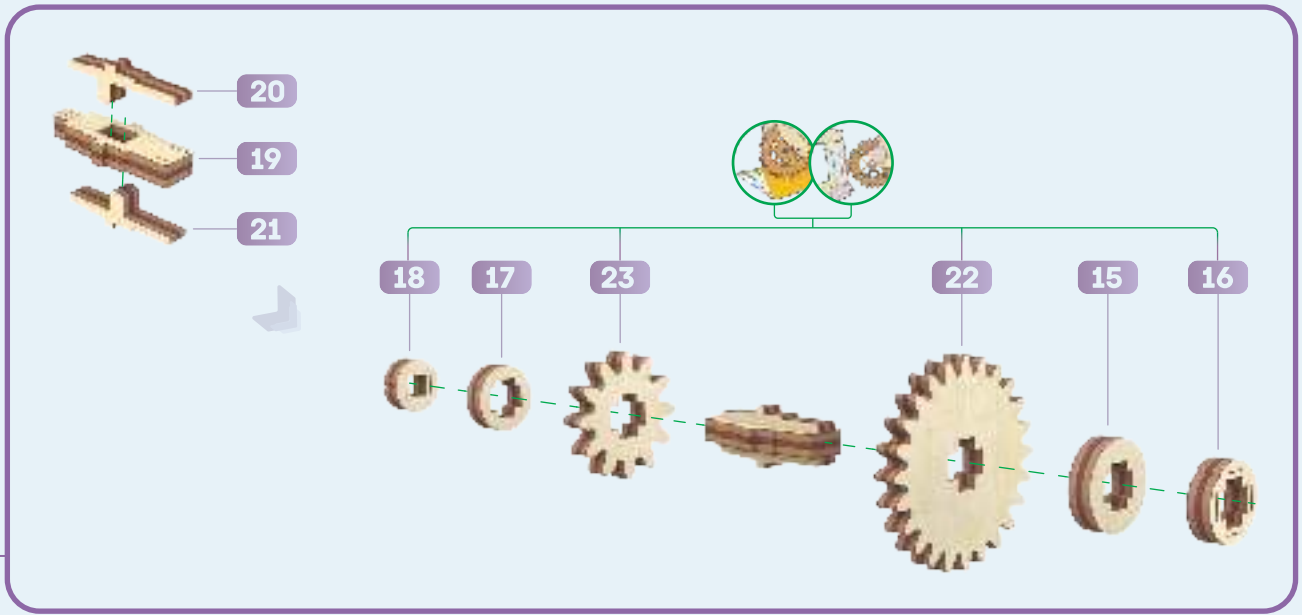
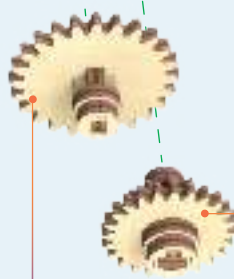
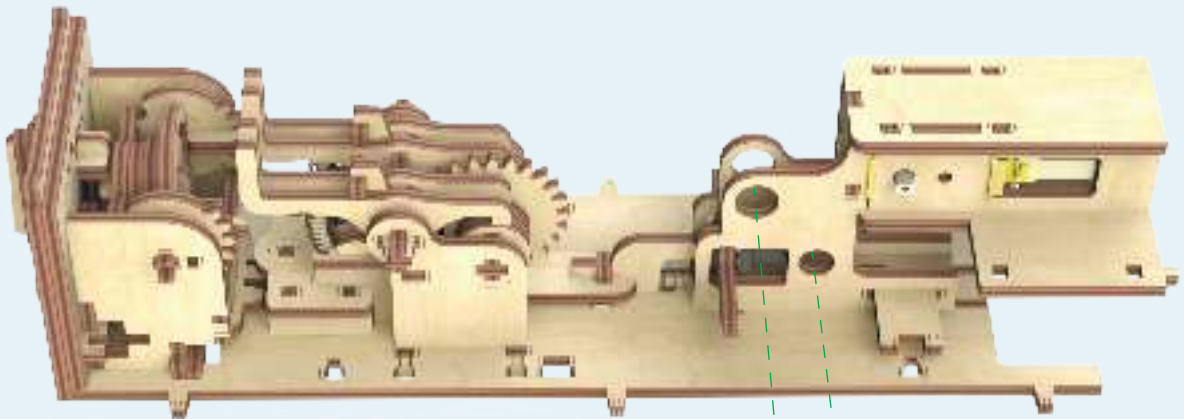

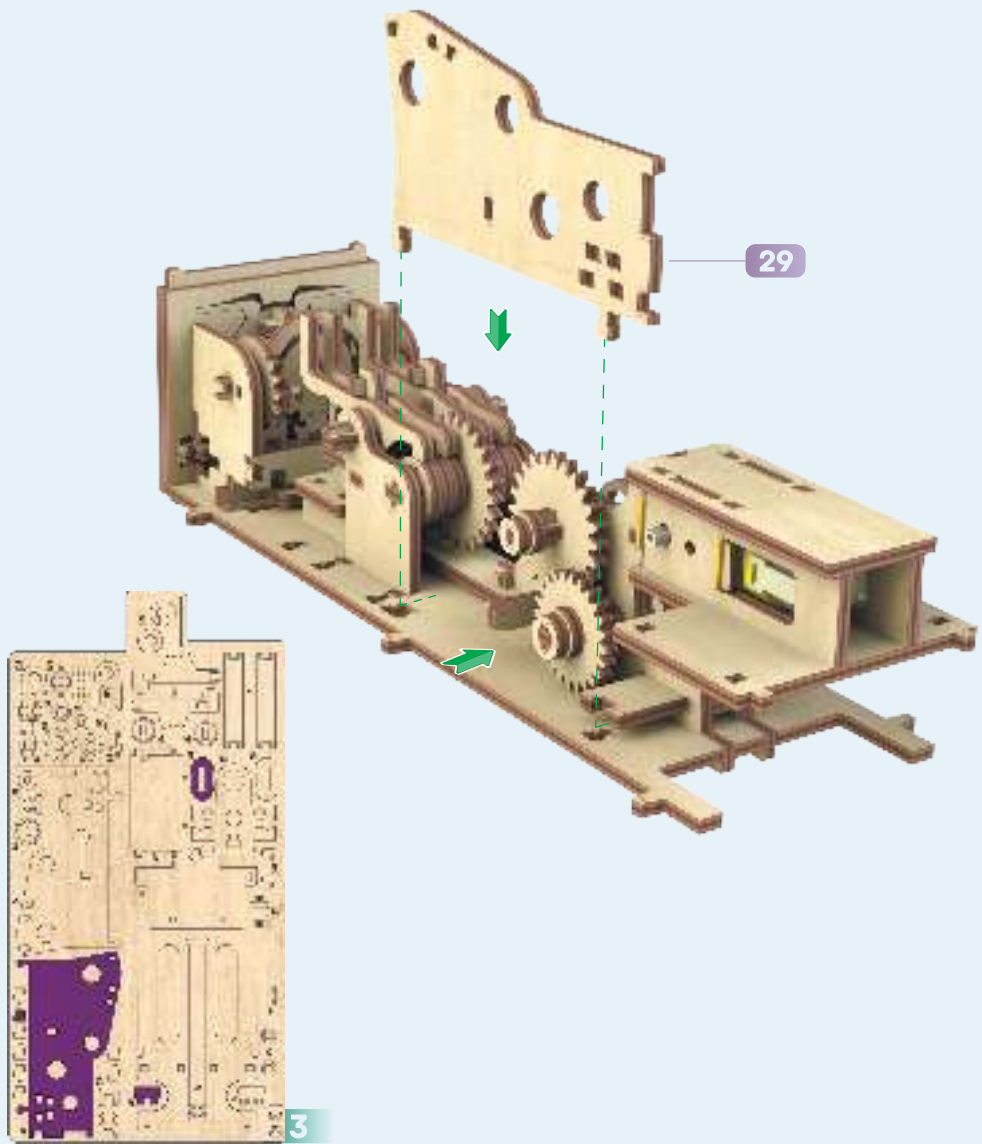

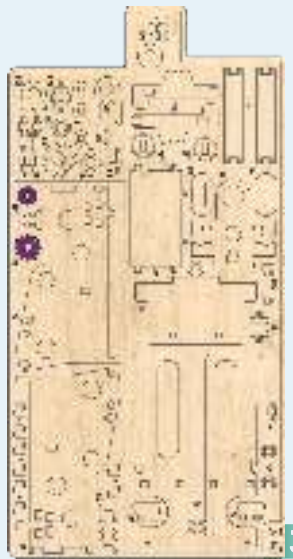

3

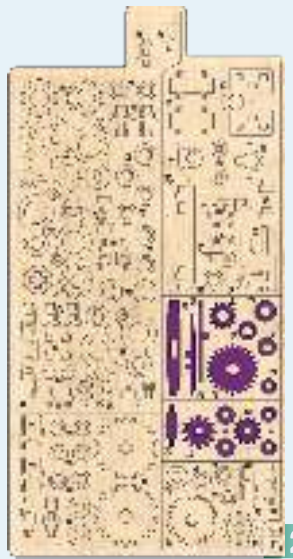
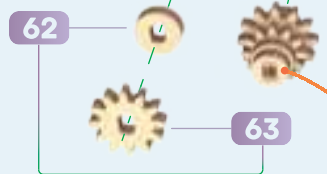

2

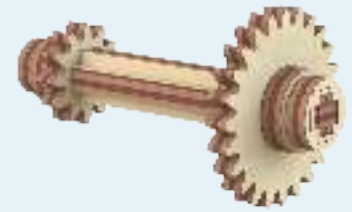
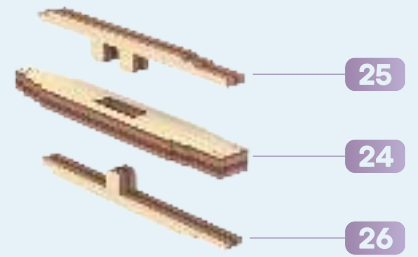
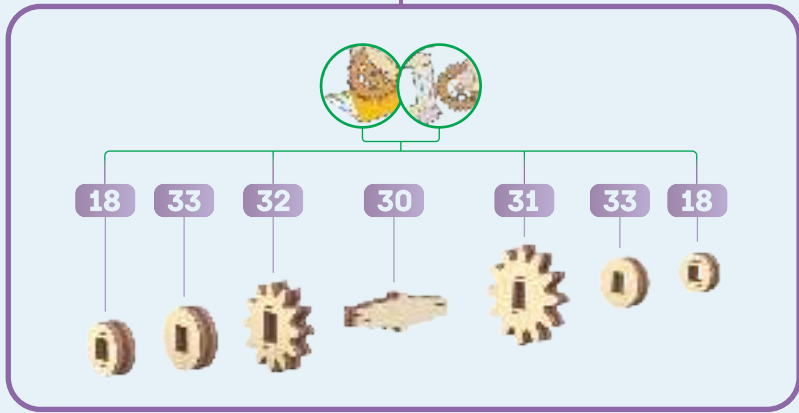

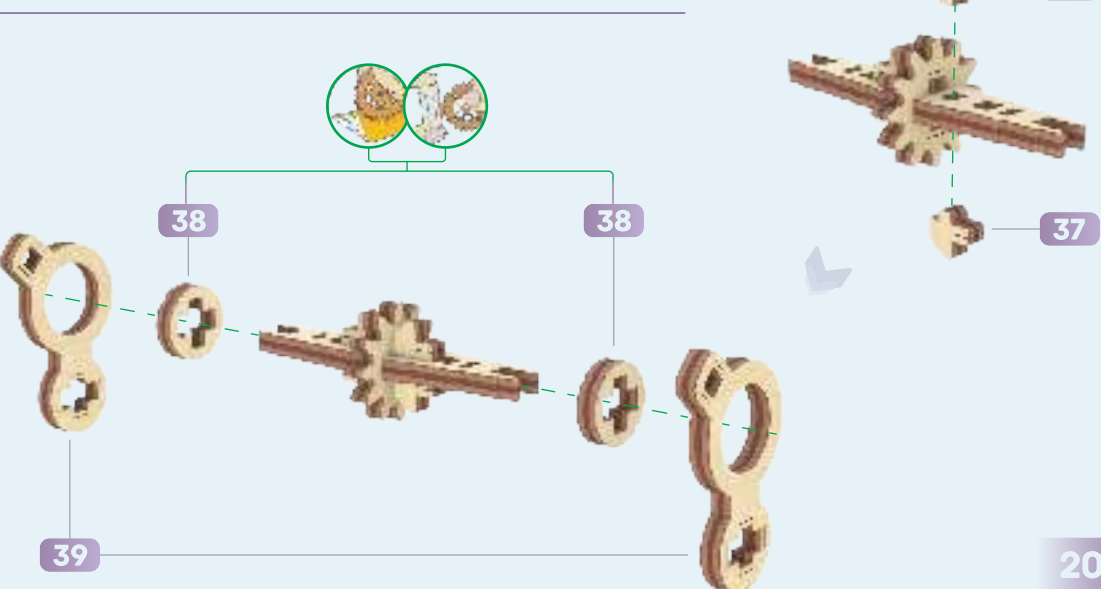
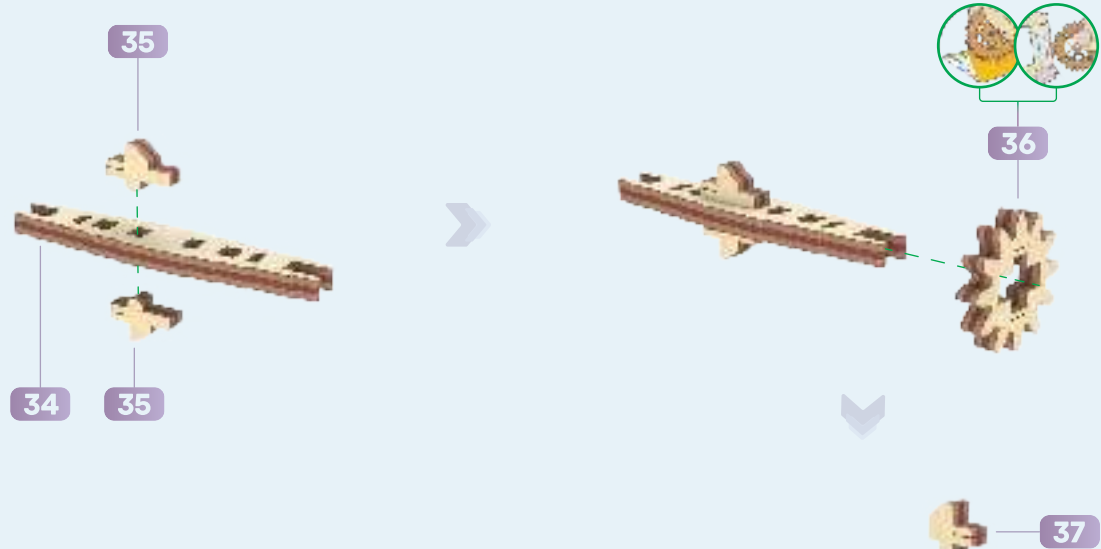
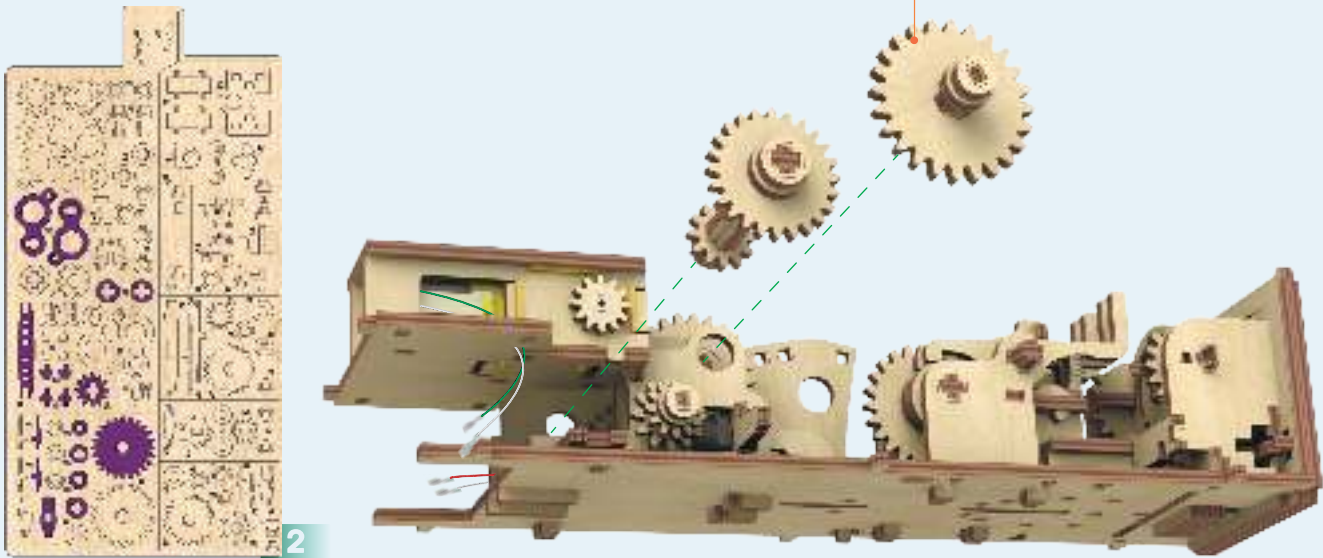
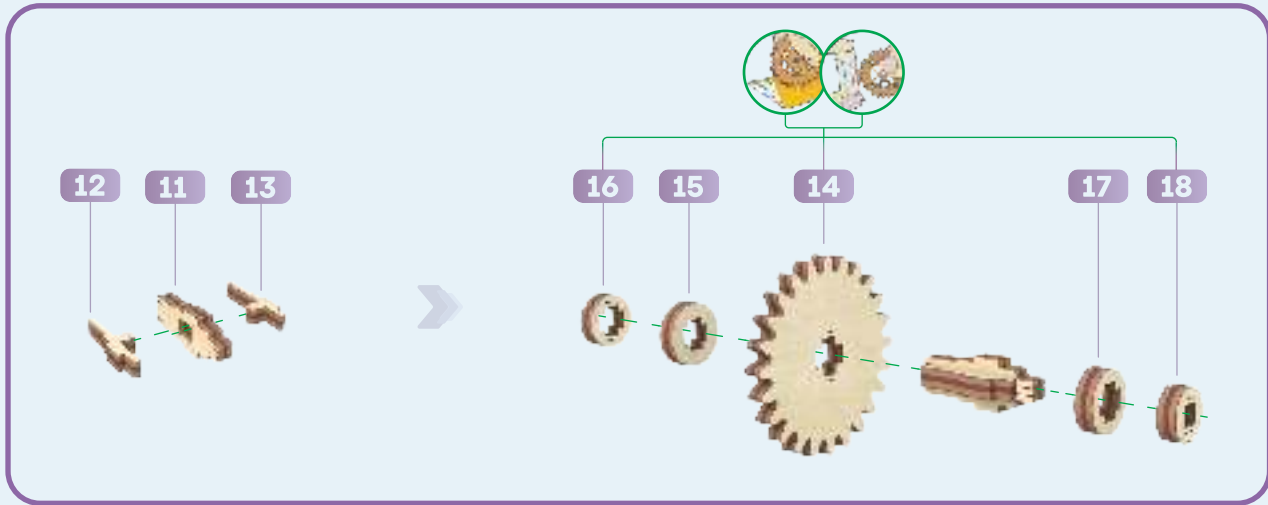

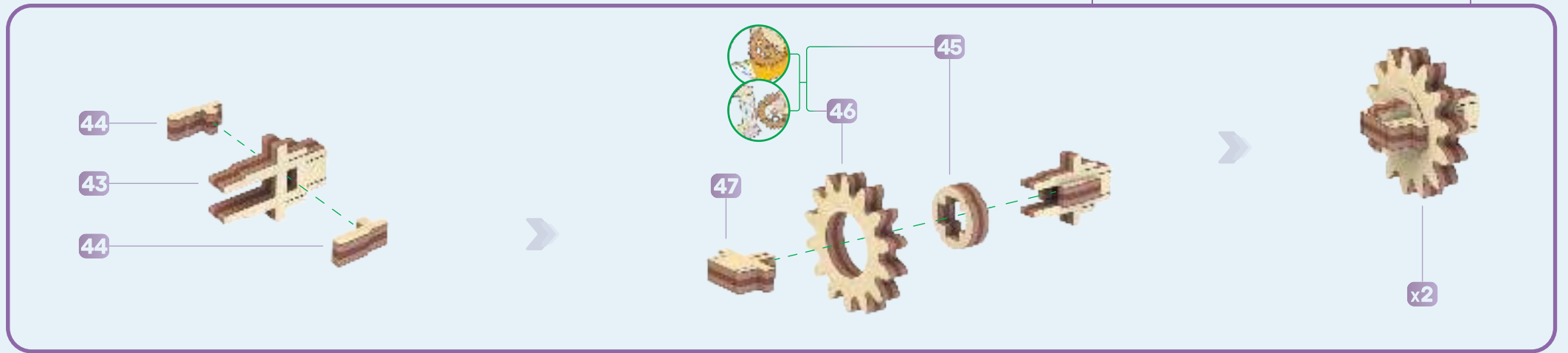
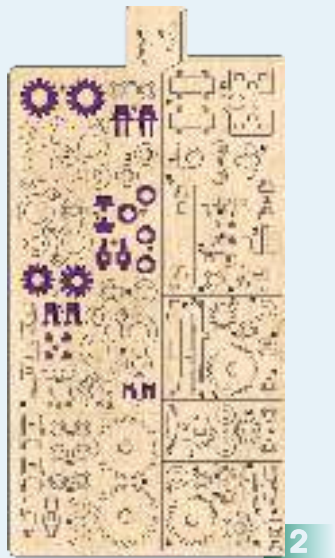
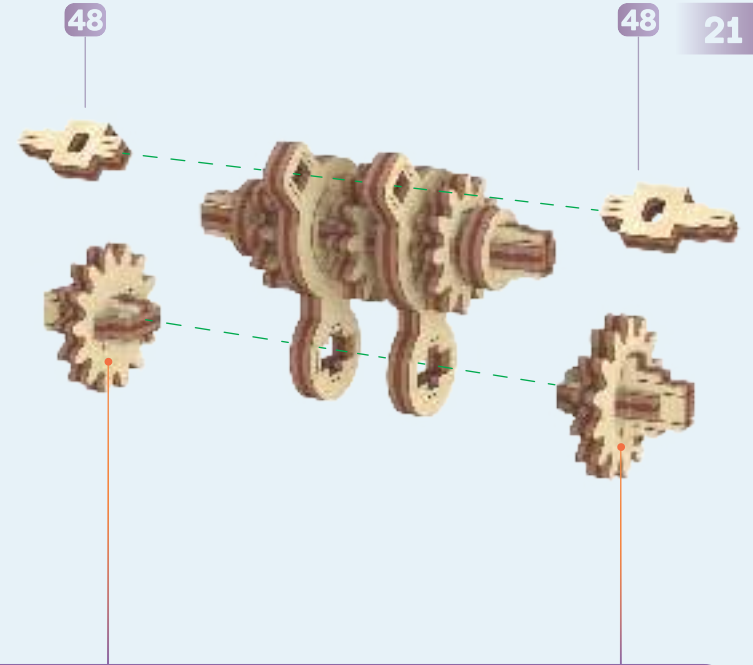
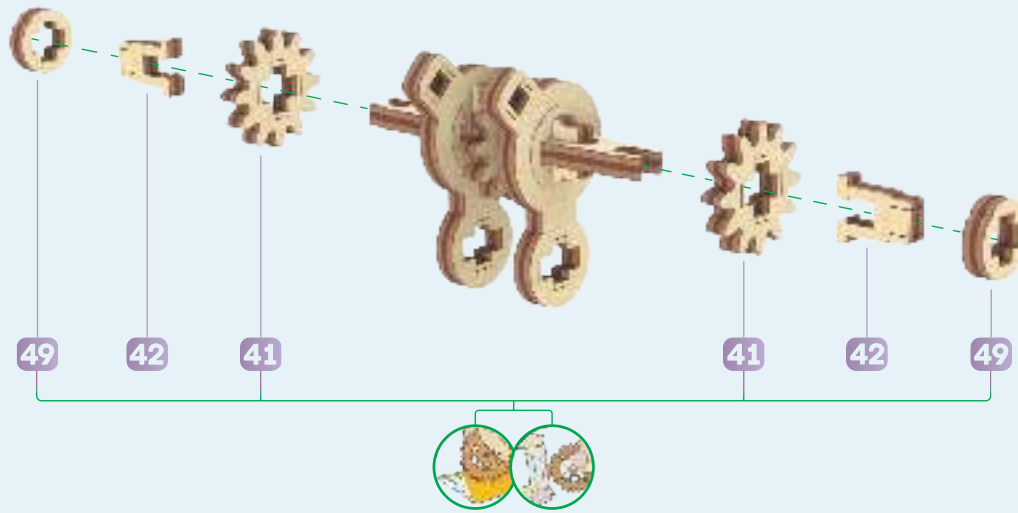
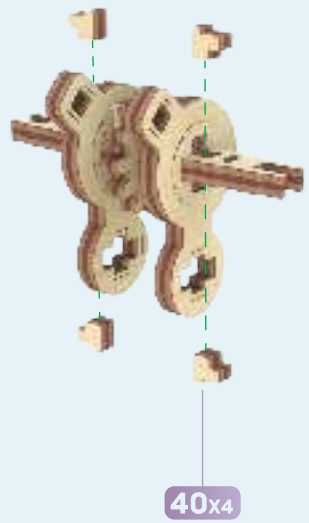

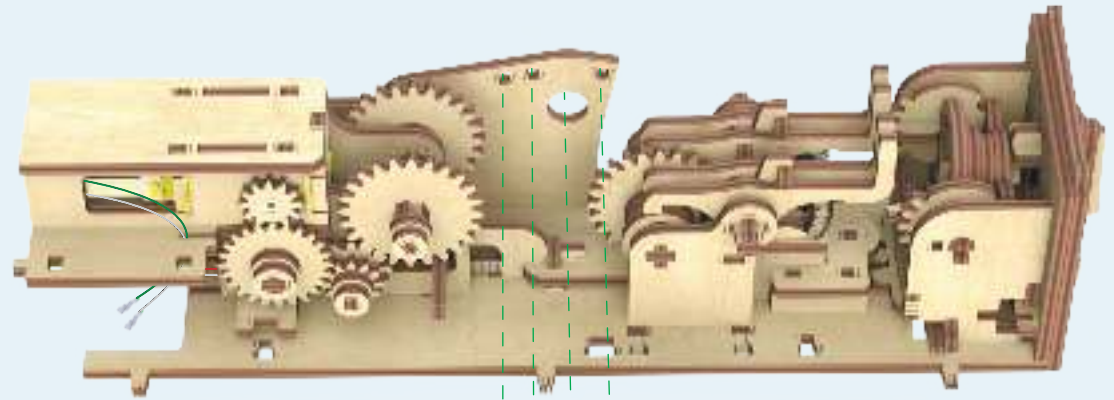
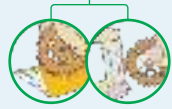
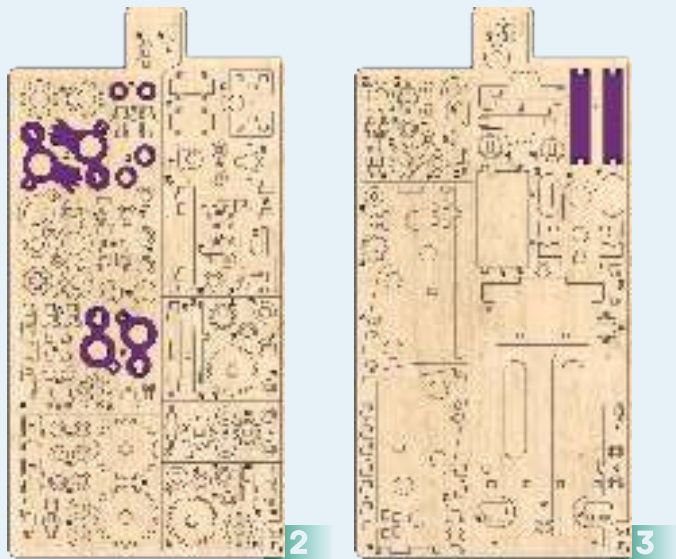
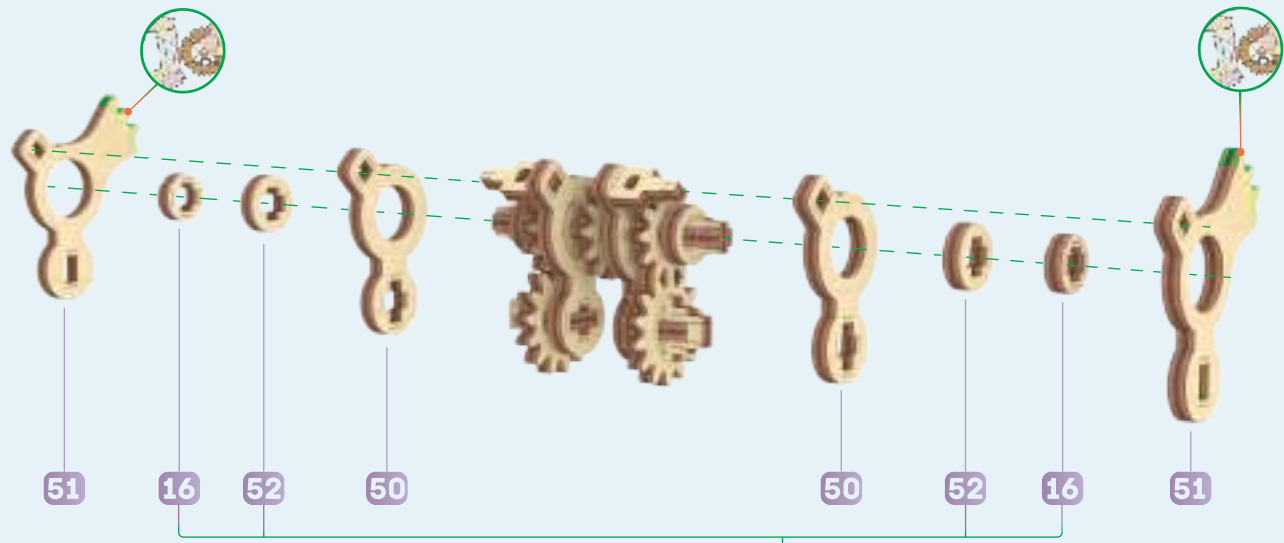

61

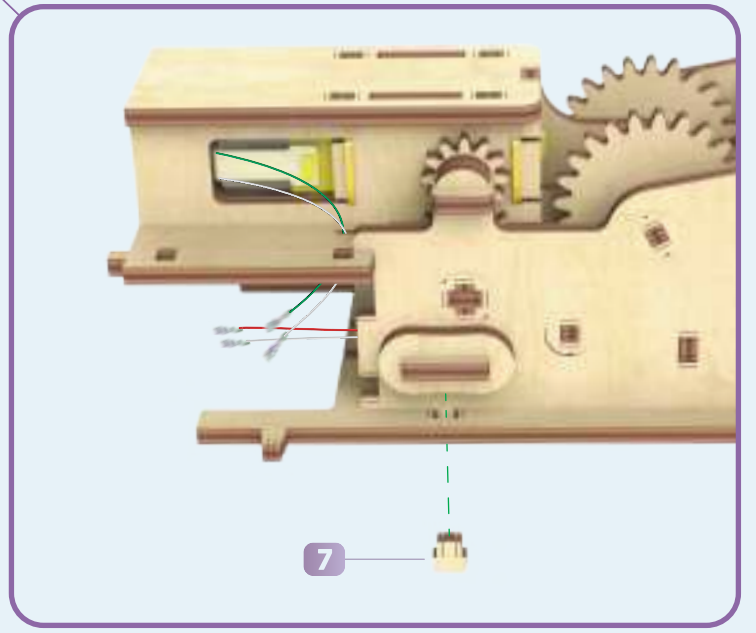
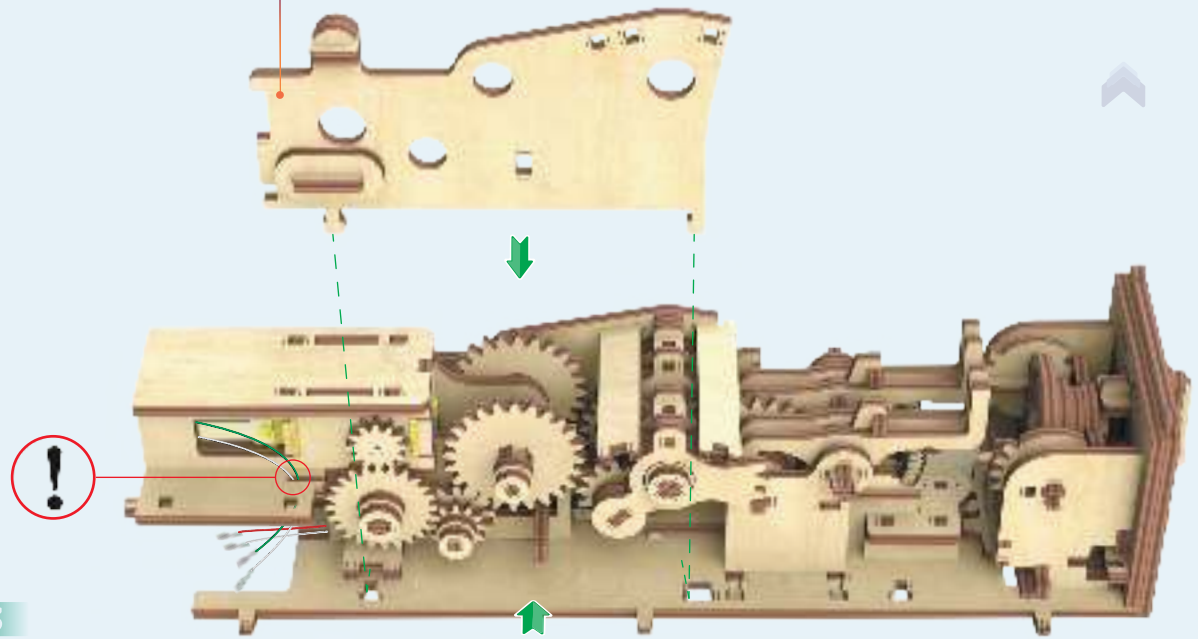
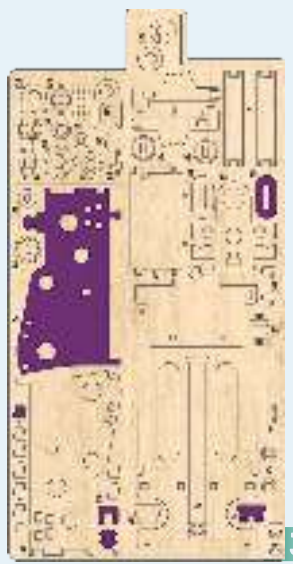
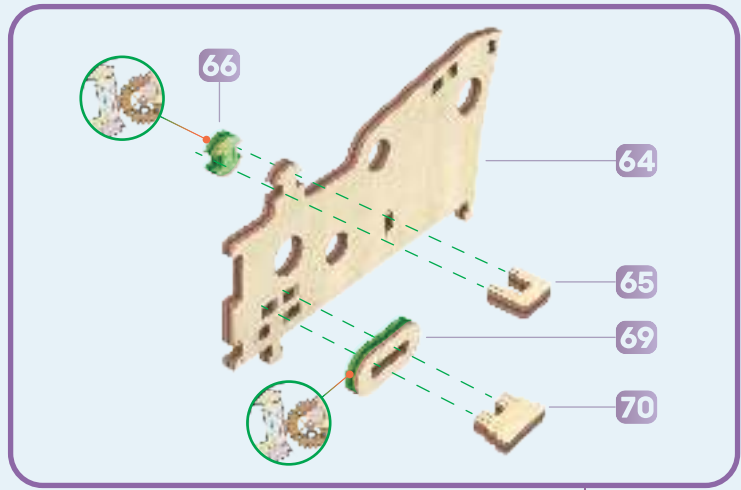



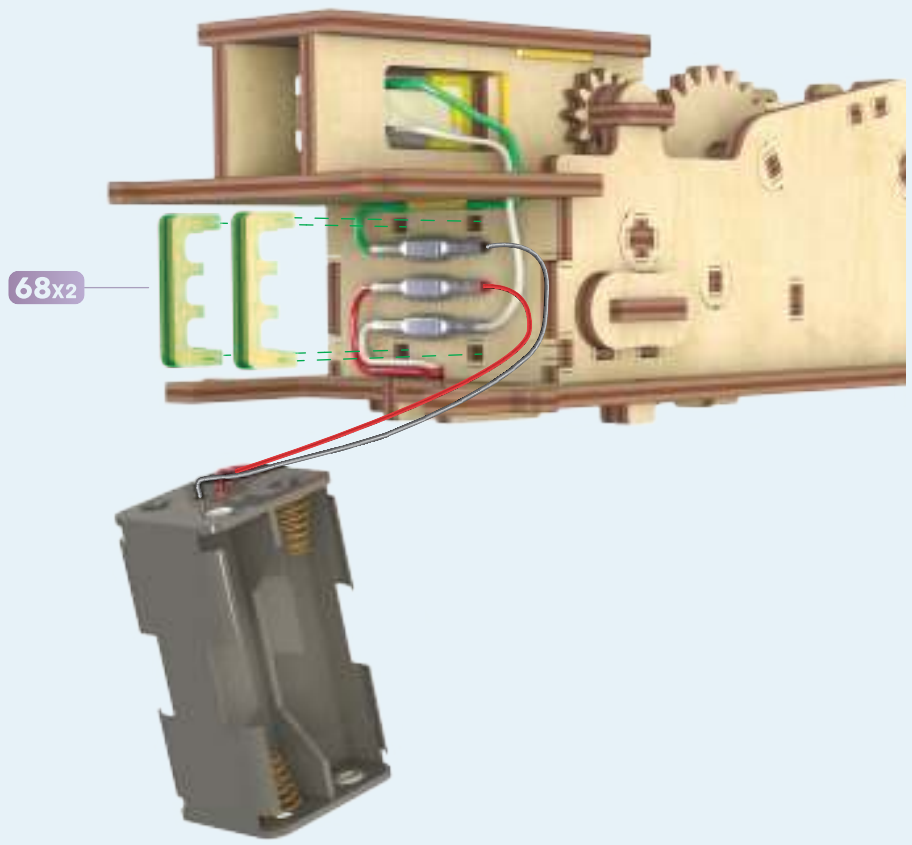
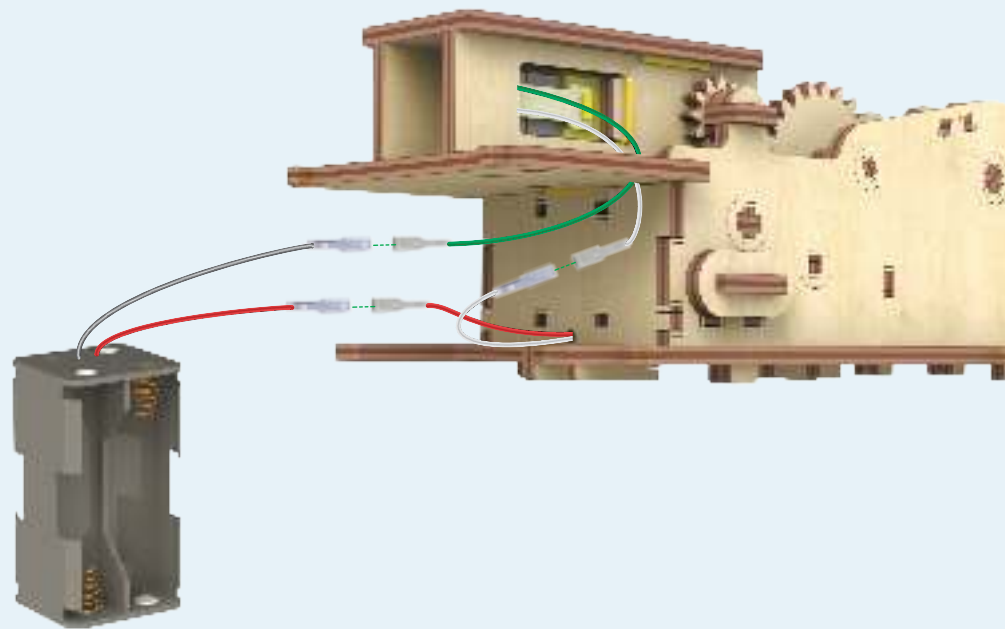
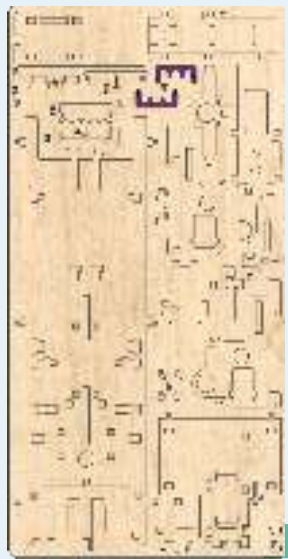
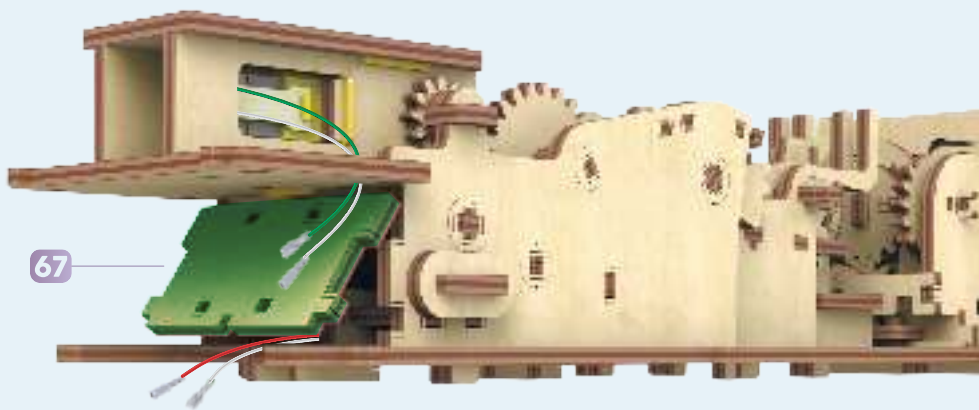
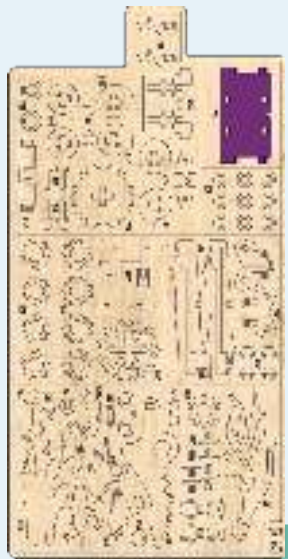

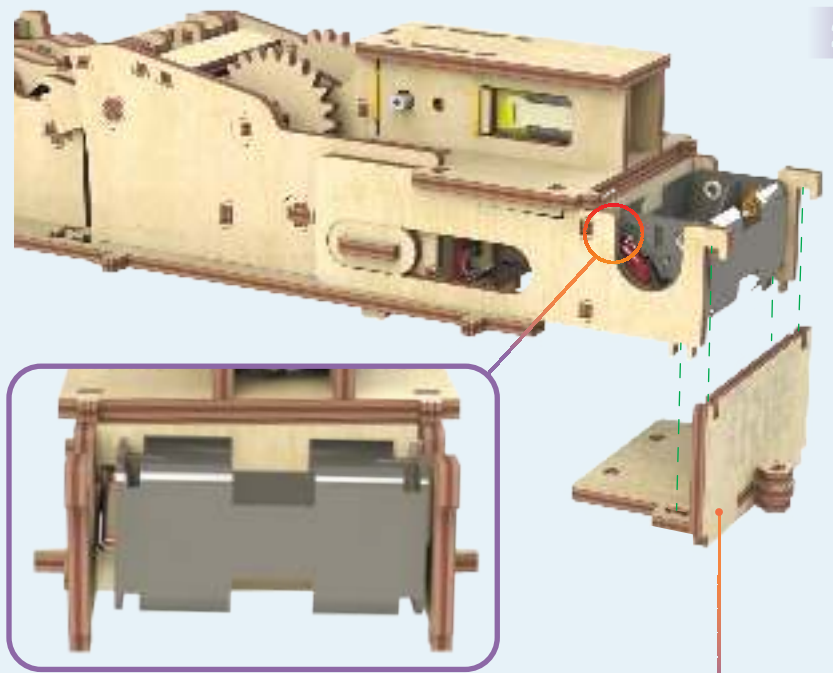
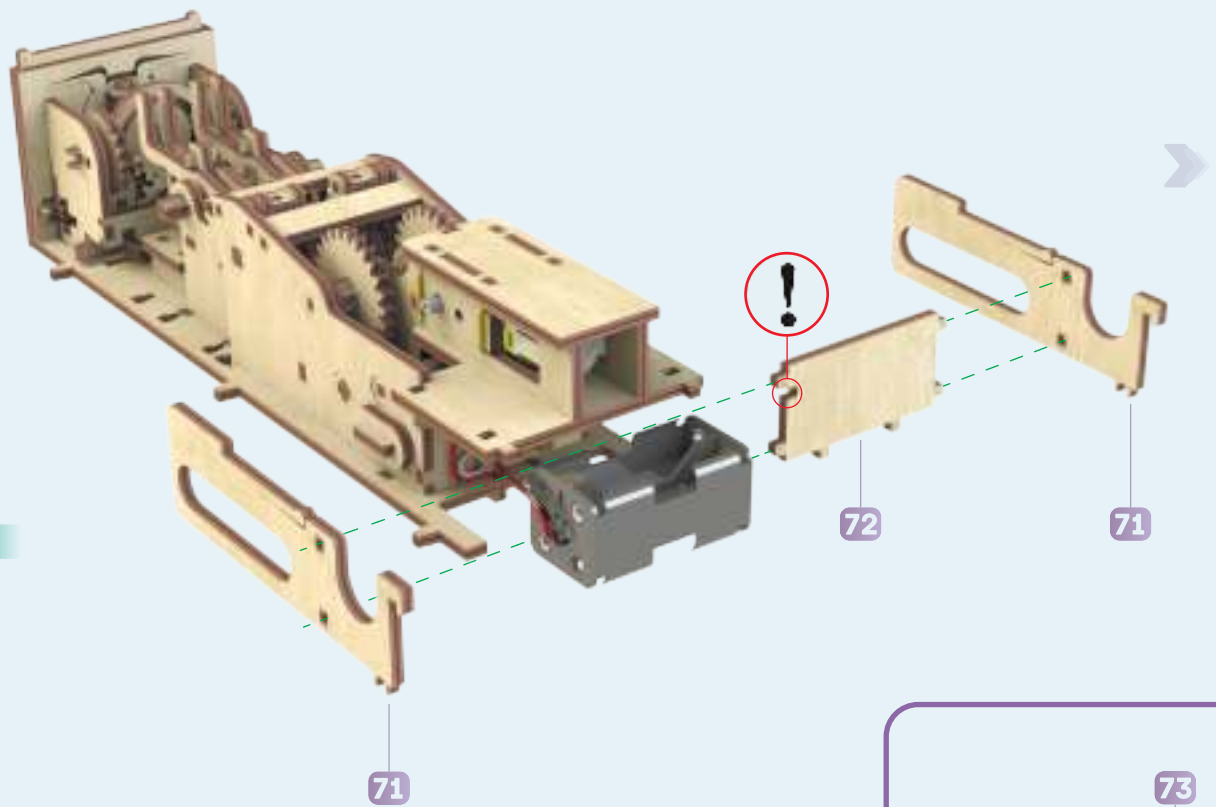
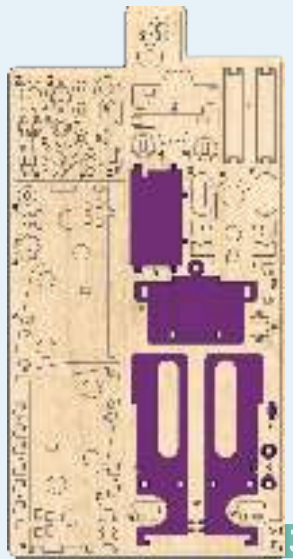

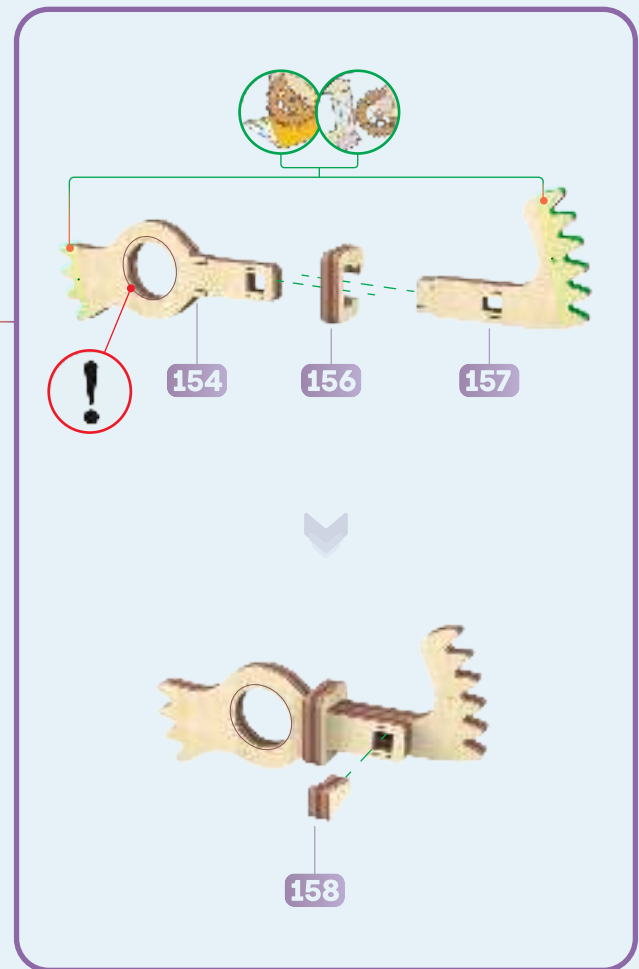
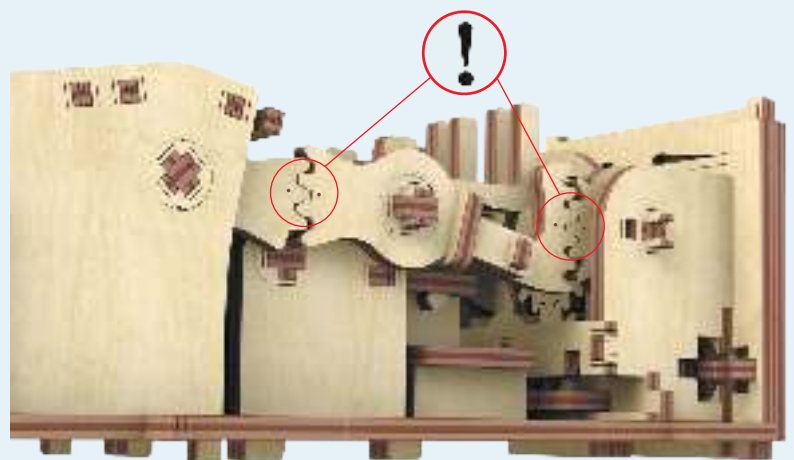
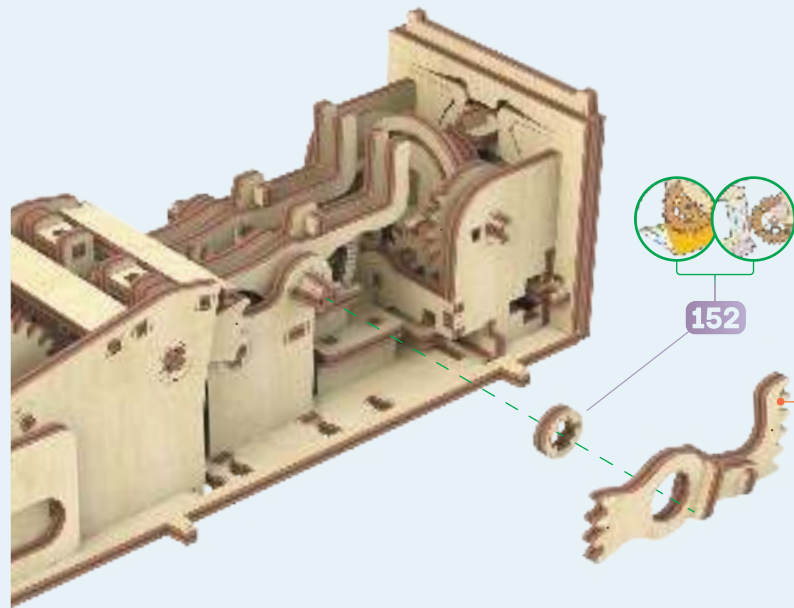
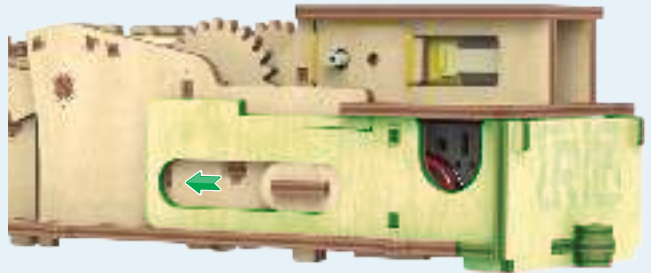
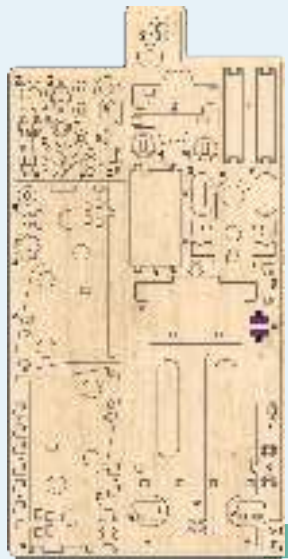
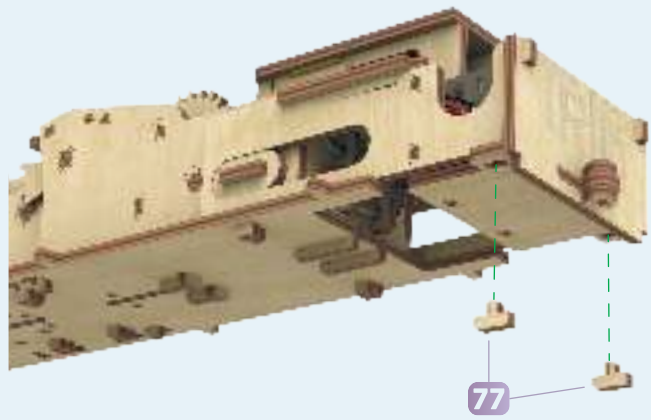
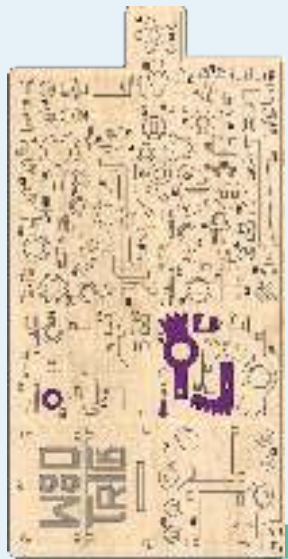

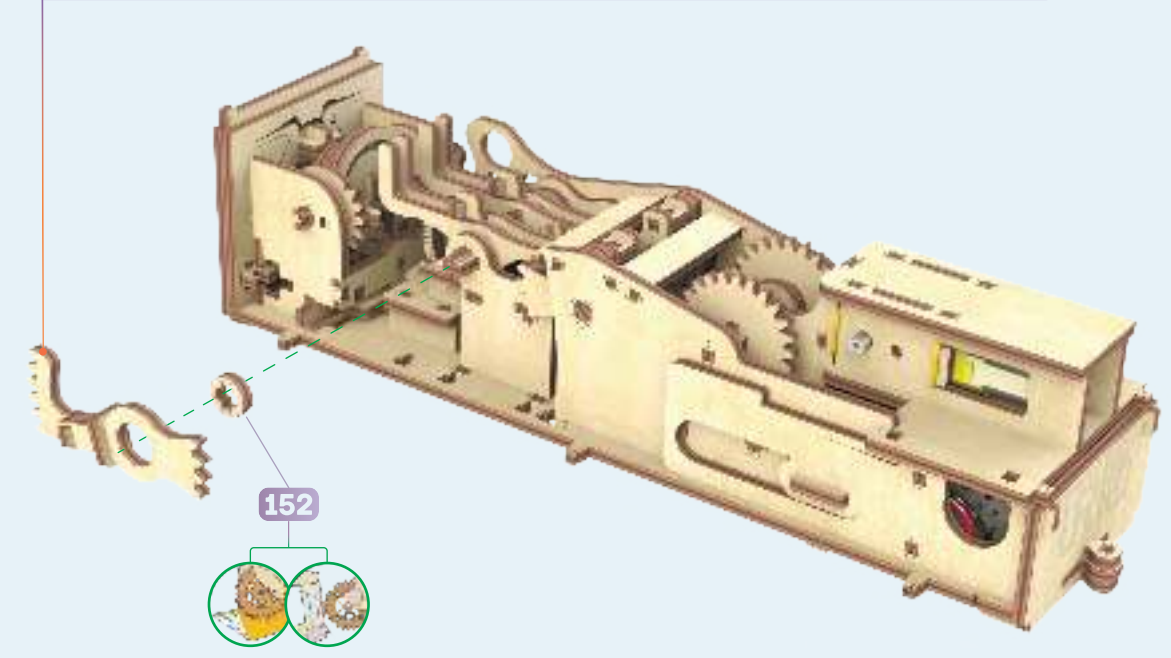
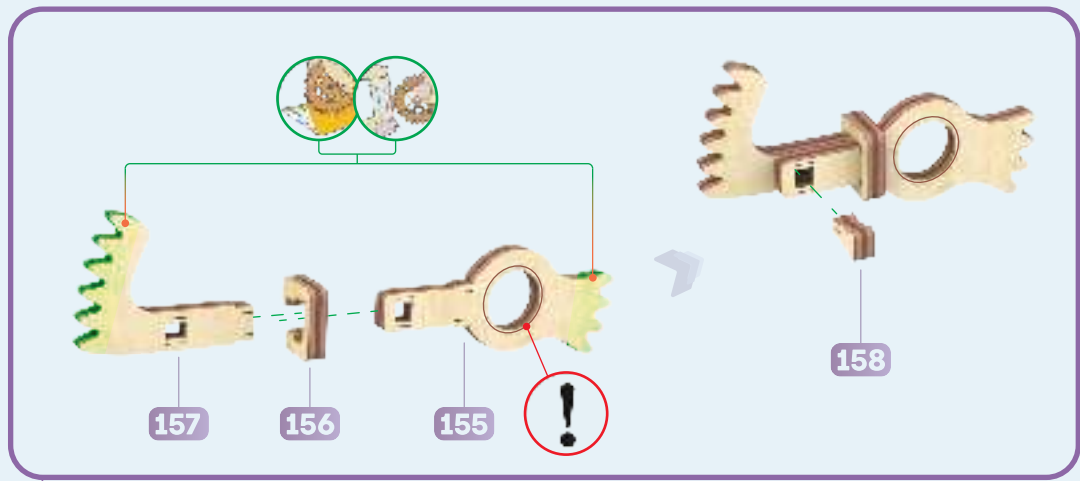
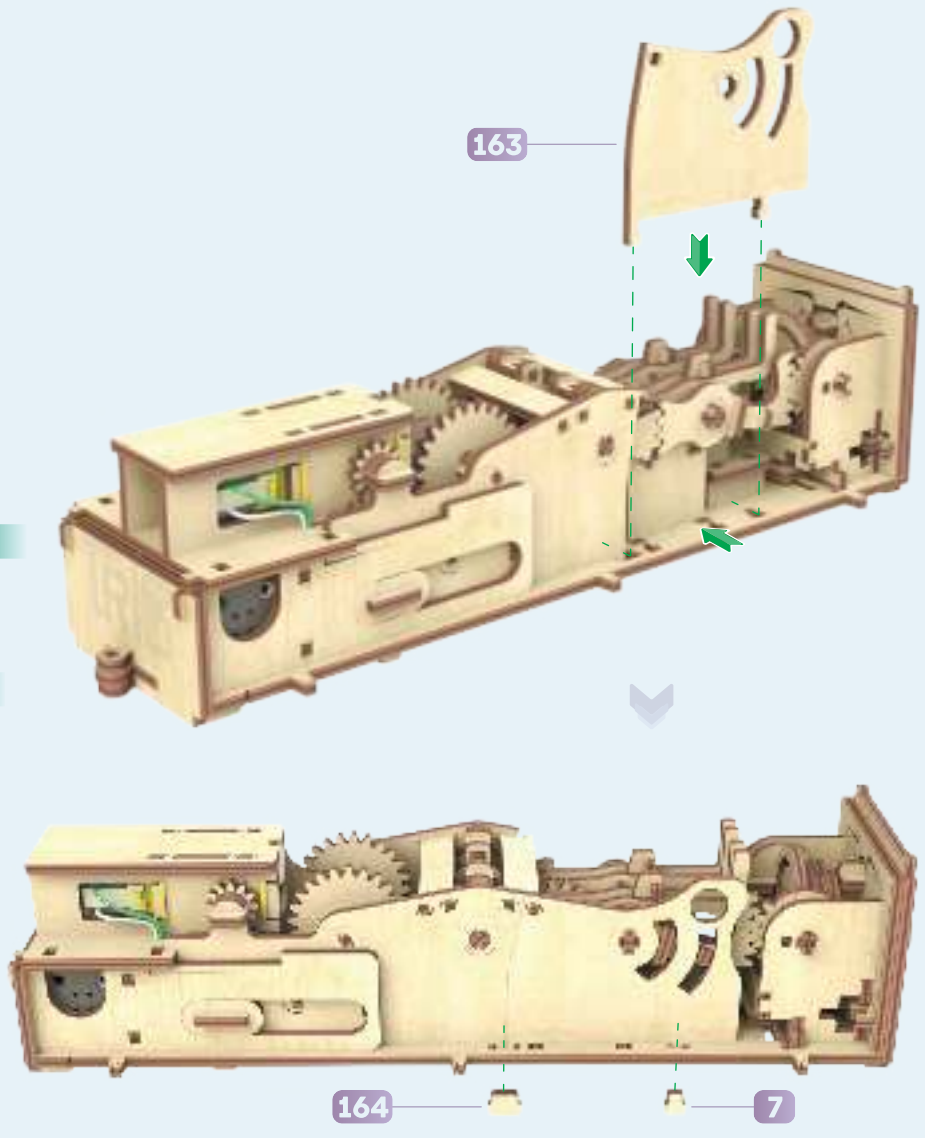
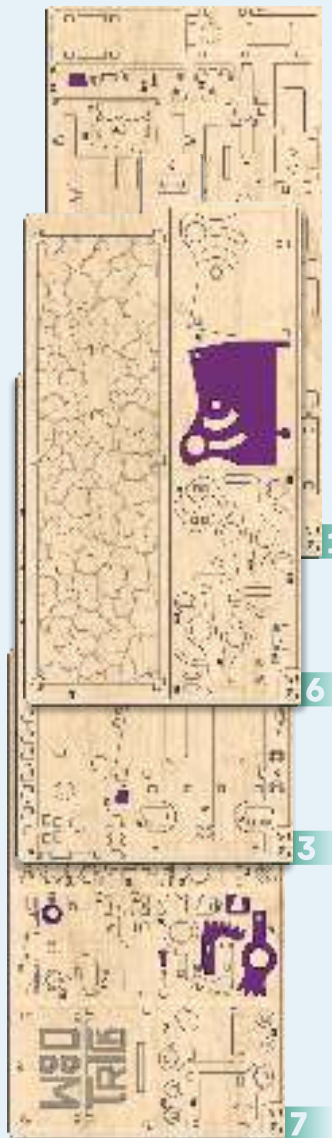

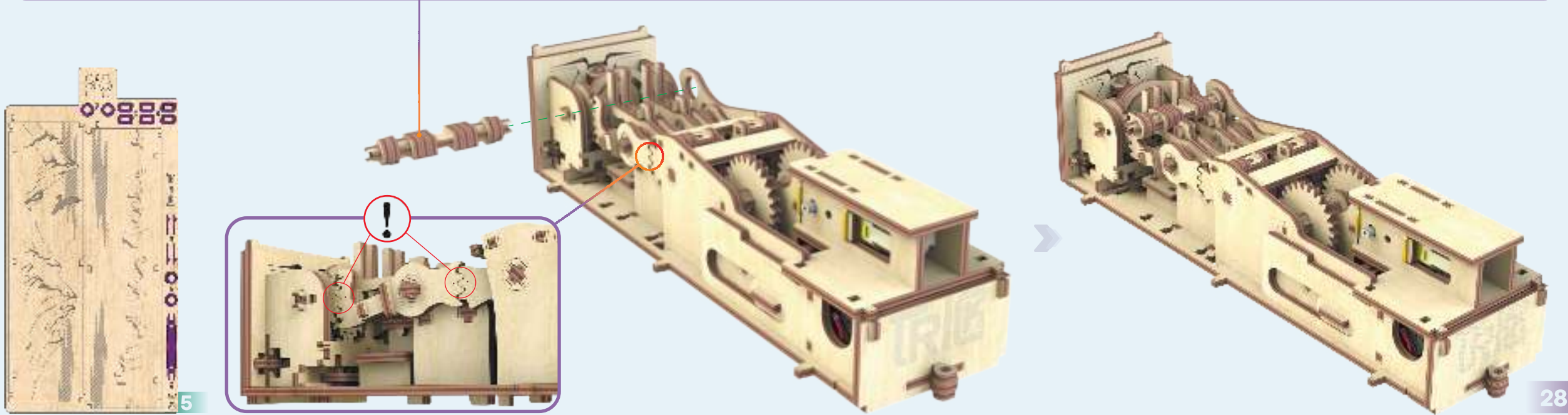
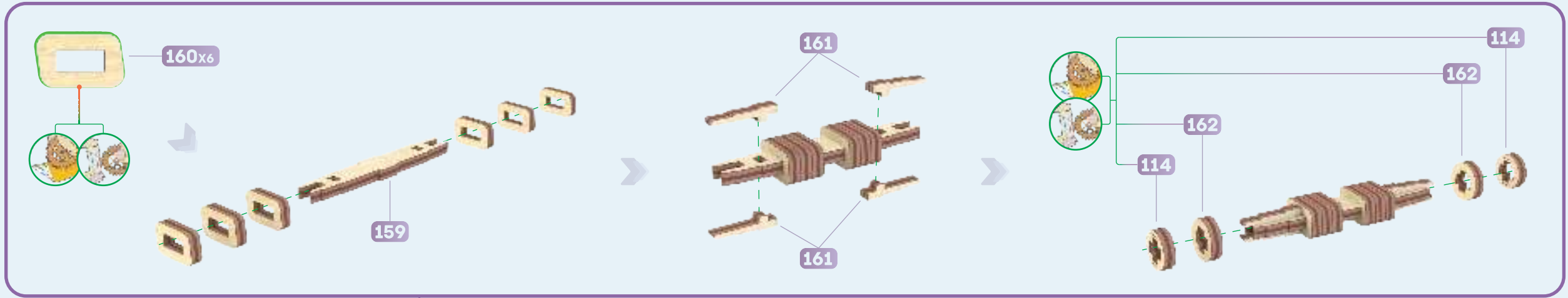

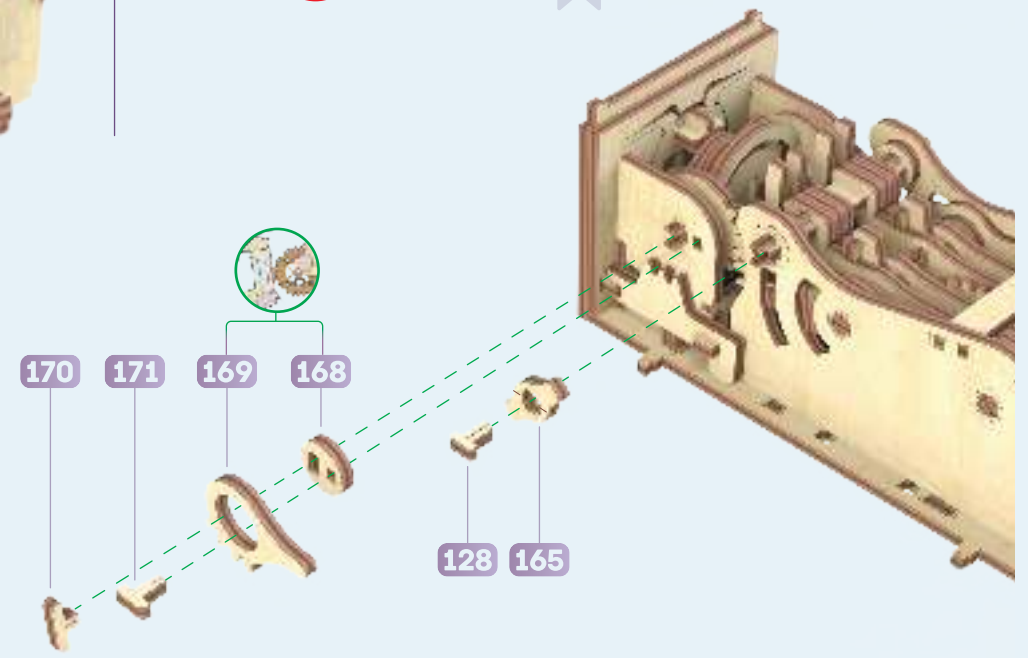
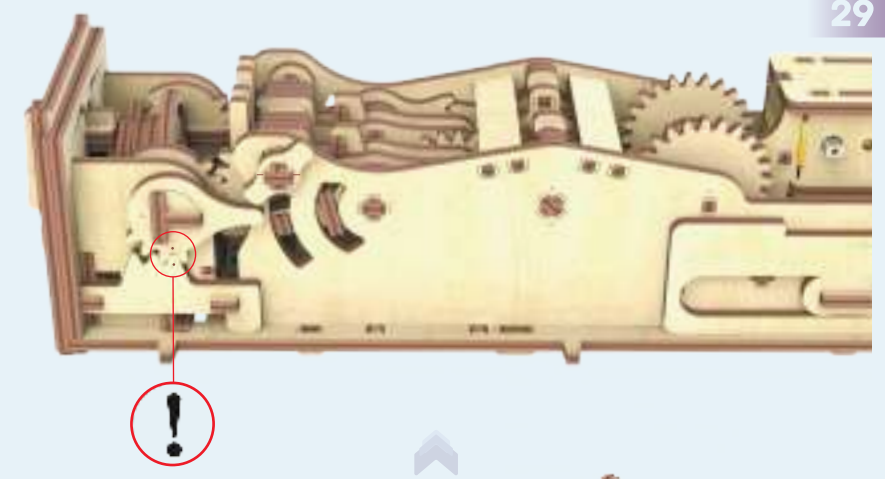
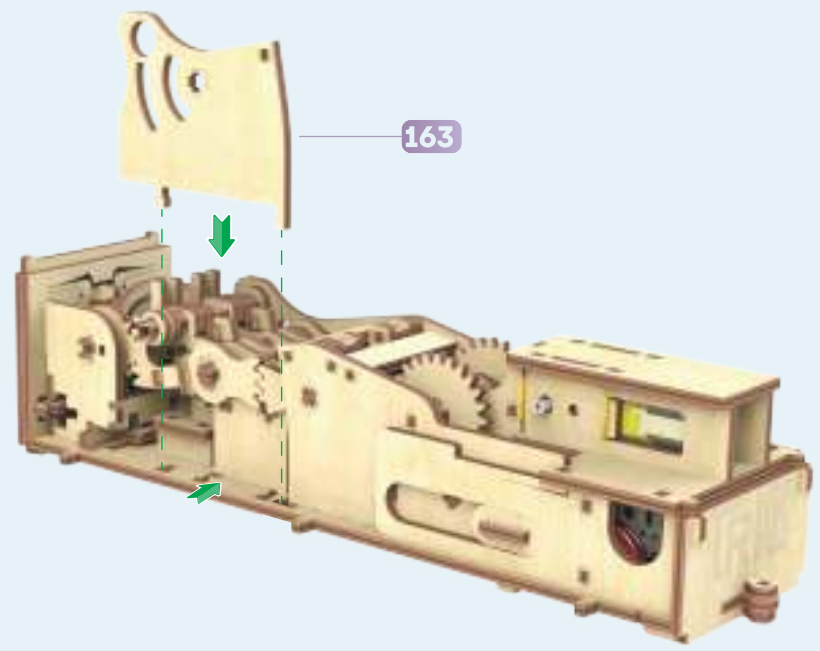
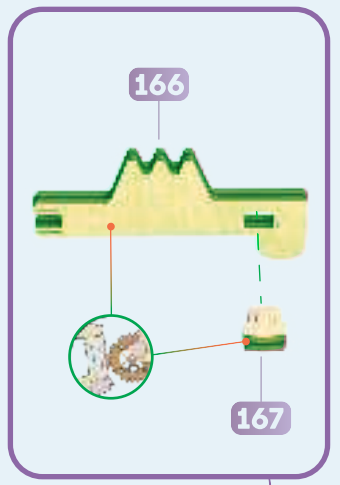

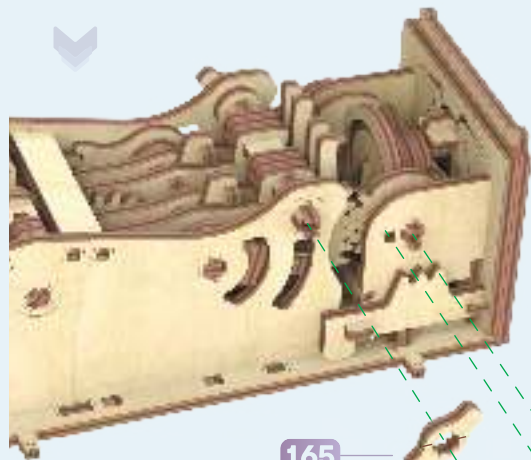
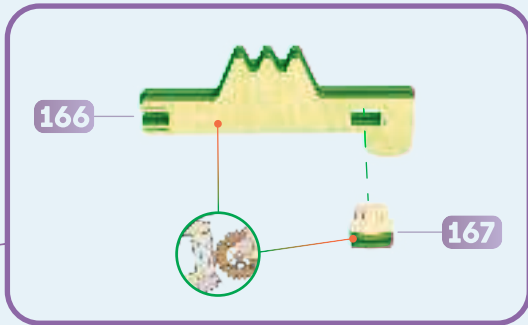
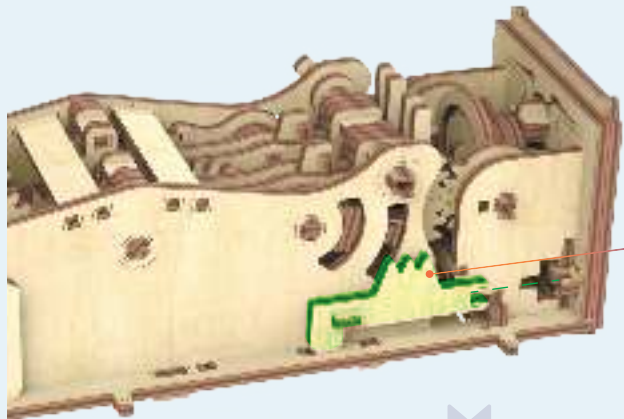

165

128

171

170

168

169

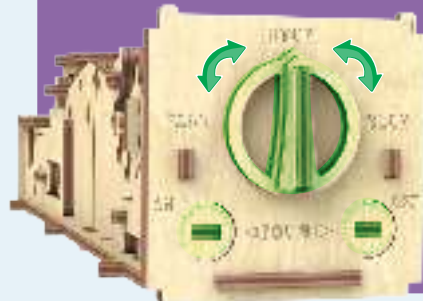

30

**UA** Після встановлення чотирьох батарейок типу (AA 1.5V) потрібно перевірити роботу механізму. Спершу розробіть механізм у положенні SLOW протягом 2-3 хвилин, потім у положенні FAST протягом 2-3 хвилин. Потім перевірте роботу кнопок ON та OFF – натискайте їх по черзі 10-15 разів кожно. У разі застрягання перевірте вал **A** вручну і потім продовжуйте. Перш ніж натиснути одну з кнопок, переконайтеся, що друга кнопка повернулася у вихідне положення.

**EN** Check the mechanism once the four (AA 1.5V) batteries have been inserted. First, run the mechanism in the SLOW position for 2-3 minutes, then in the FAST position for 2-3 minutes. Then check the ON and OFF buttons by pressing them alternately 10-15 times. If stuck, turn the **A** shaft manually and then resume. Before pressing one of the buttons, make sure the other button has reset to its original position.

**DE** Nach dem Einsetzen von vier Batterien (AA 1.5V) muss der Mechanismus überprüft werden. Zuerst den Mechanismus in der SLOW-Position für 2-3 Minuten und dann in der FAST-Position für 2-3 Minuten ausarbeiten. Überprüfen Sie dann die Funktion der ON- und OFF-Tasten – drücken Sie sie jeweils 10 bis 15 Mal abwechselnd. Wenn ein Hängenbleiben auftritt, drehen Sie die Welle **A** von Hand und fahren Sie dann fort. Stellen Sie sicher, dass die zweite Taste in die Ausgangsposition zurückkehrt, bevor Sie die erste Taste drücken.

**FR** Après l'installation de quatre piles de type (AA 1.5V), il est nécessaire de tester le fonctionnement du mécanisme. Premièrement, faites fonctionner le mécanisme dans la position SLOW pendant 2 ou 3 minutes, puis dans la position FAST pendant 2 ou 3 minutes. Ensuite vérifiez le fonctionnement des boutons ON et OFF en les appuyant l'un après l'autre 10 ou 15 fois chacun. En cas de blocage, tournez l'arbre **A** manuellement et continuez. Avant d'appuyer sur l'un des boutons, assurez-vous que l'autre bouton est revenu dans sa position initiale.

**IT** Dopo aver installato quattro batterie di tipo (AA 1.5V), è necessario verificare il funzionamento del meccanismo. In primo luogo, usare il meccanismo nella posizione SLOW per 2-3 minuti, dopodiché nella posizione FAST per 2-3 minuti. Quindi controllare il funzionamento dei pulsanti ON e OFF – premerti a turno 10-15 volte ciascuno. In caso di inceppamento, ruotare manualmente l'albero **A** e poi proseguire. Prima di premere uno dei pulsanti, assicurarsi che il secondo pulsante sia tornato alla sua posizione originale.

**ES** Una vez colocadas cuatro pilas (del tipo AA 1.5V) debe comprobar el funcionamiento del mecanismo. Primero, accione el mecanismo en posición SLOW durante 2-3 minutos, luego en posición FAST durante 2-3 minutos. A continuación, compruebe el funcionamiento de los botones ON y OFF pulsándolos alternativamente de 10 a 15 veces. Si se bloquea, gire manualmente el eje **A** y prosiga adelante. Antes de presionar uno de los botones, asegúrese de que el otro botón ha vuelto a su posición original.

**PL** Po włożeniu czterech baterii typu (AA 1.5 V) należy sprawdzić działanie mechanizmu. Najpierw należy rozruszać mechanizm w pozycji SLOW przez 2-3 minuty, a następnie w pozycji FAST przez 2-3 minuty. Następnie należy sprawdzić działanie przycisków ON i OFF, naciskając je naprzemiennie 10-15 razy. W przypadku zablokowania należy ręcznie obrócić wałek **A**, a następnie kontynuować. Przed naciśnięciem jednego z przycisków należy upewnić się, że drugi przycisk powrócił do swojej pierwotnej pozycji.

**JP** 電池 4 本 (1.5V 単三型) を取り付けたら、機構の動作を確認する必要があります。最初に SLOW 位置で 2 ~ 3 分間メカニズムを開発し、次に FAST 位置で 2 ~ 3 分間メカニズムを開発します。次に、ON ボタンと OFF ボタンの動作を確認します。それぞれ 10 ~ 15 回交互に押しします。固着している場合は、シャフト **A** を手で回してから続けてください。ボタンのいずれかを押す前に、2 番目のボタンが元の位置に戻っていることを確認してください。

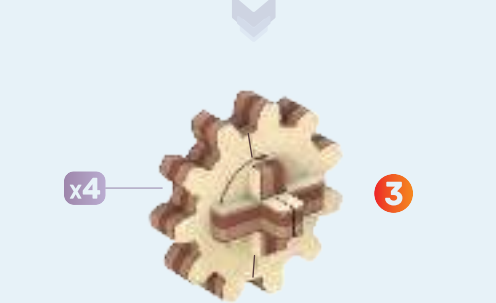
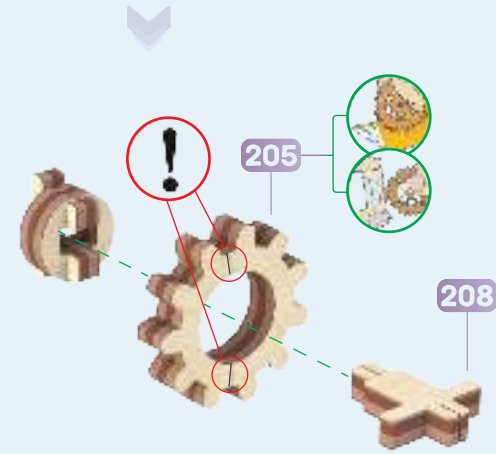
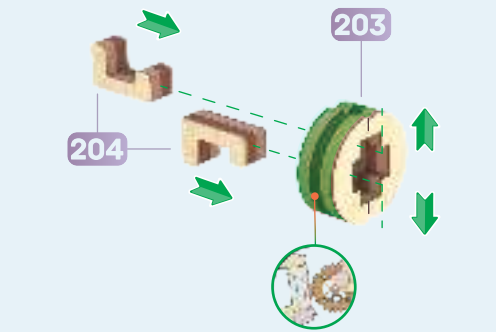
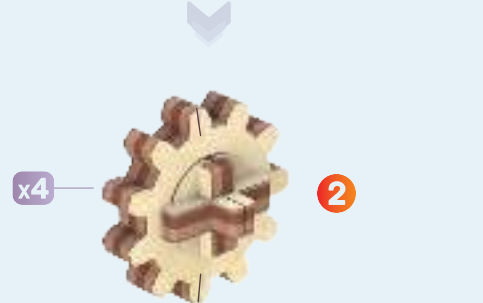
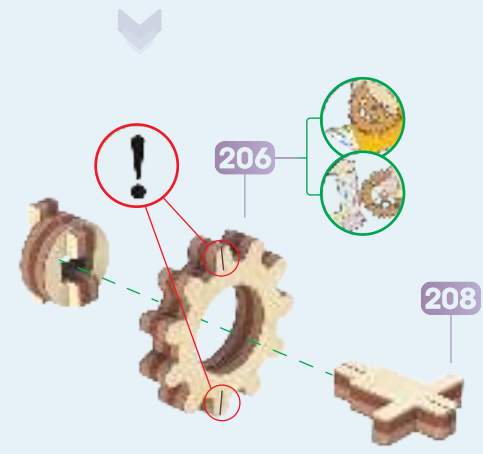
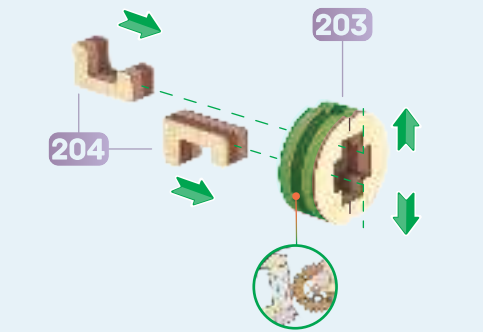
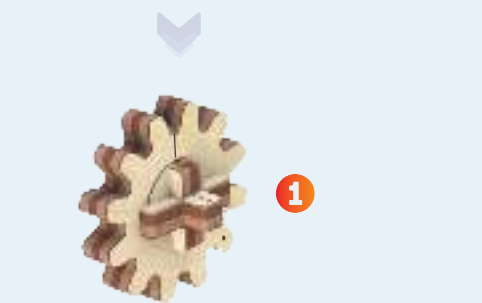
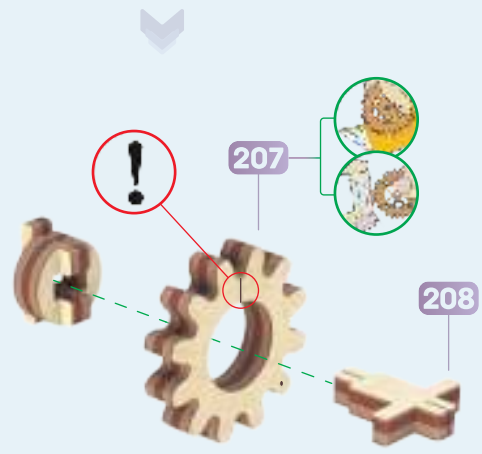
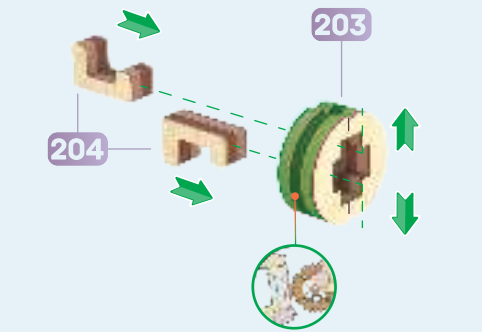
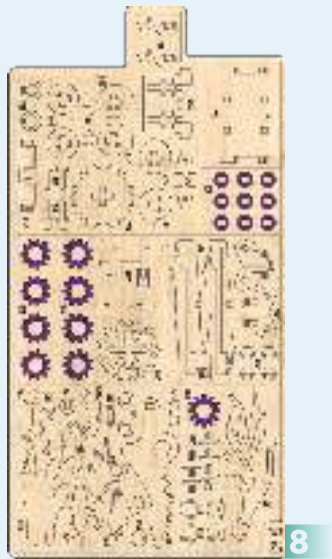





10

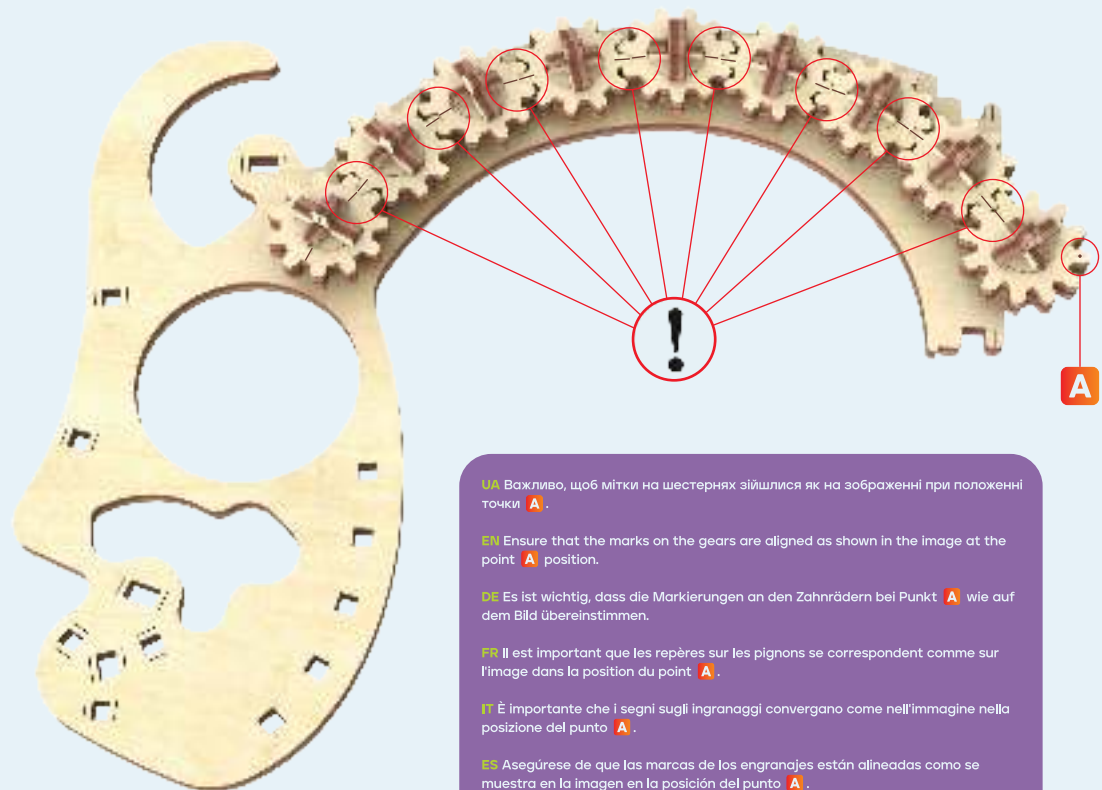
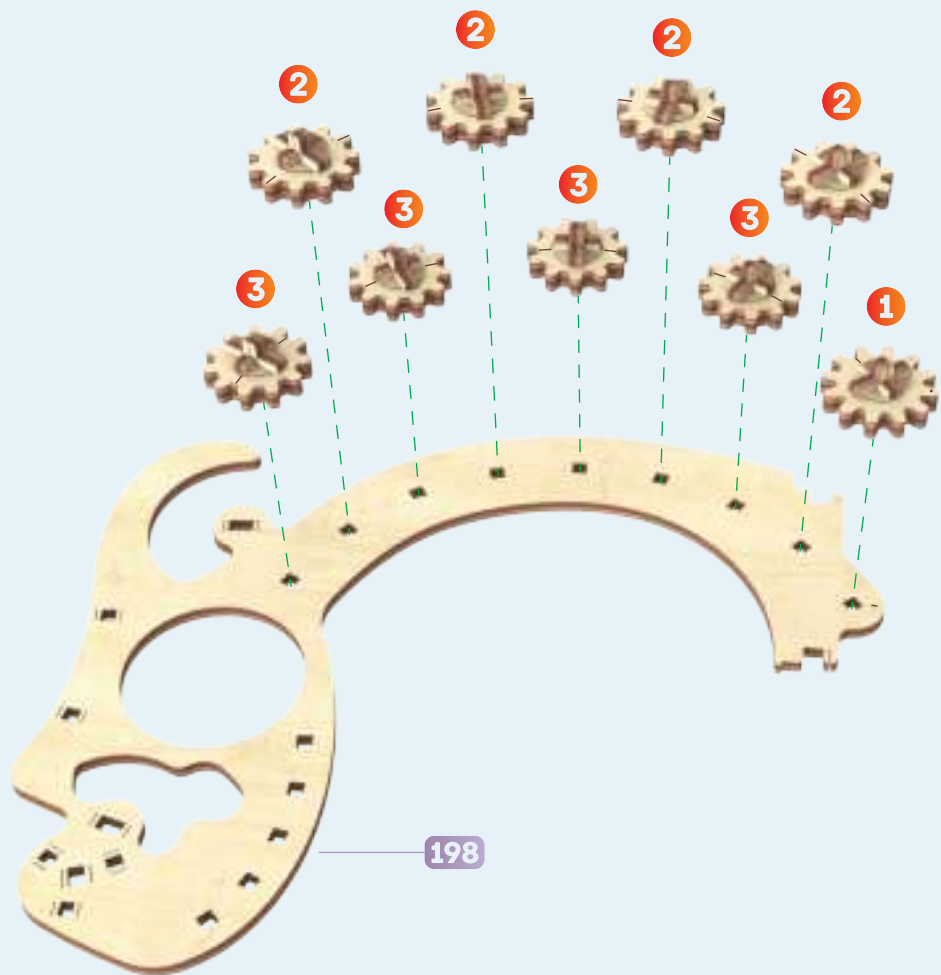

**UA** Важливо, щоб мітки на шестернях зійшлися як на зображенні при положенні точки **A**.

**EN** Ensure that the marks on the gears are aligned as shown in the image at the point **A** position.

**DE** Es ist wichtig, dass die Markierungen an den Zahnrädern bei Punkt **A** wie auf dem Bild übereinstimmen.

**FR** Il est important que les repères sur les pignons se correspondent comme sur l'image dans la position du point **A**.

**IT** È importante che i segni sugli ingranaggi convergano come nell'immagine nella posizione del punto **A**.

**ES** Asegúrese de que las marcas de los engranajes están alineadas como se muestra en la imagen en la posición del punto **A**.

**PL** Ważne jest, aby oznaczenia na kołach zębatych były ustawione tak, jak na rysunku w punkcie **A**.

**JP** 画像のように歯車のマークが **A** 点の位置に集まることが重要です。

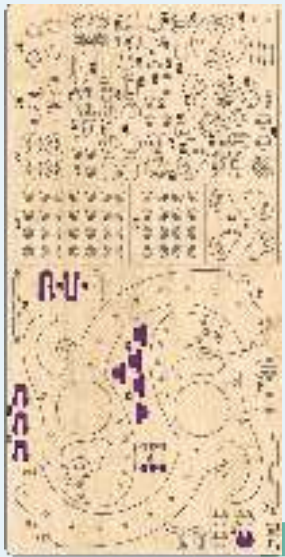

10

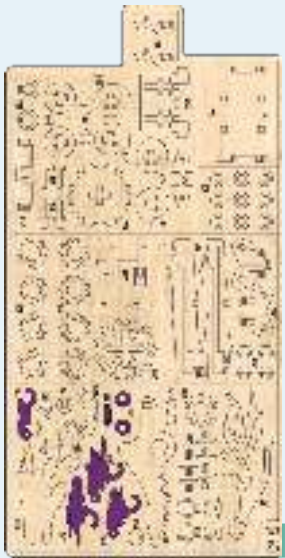

8

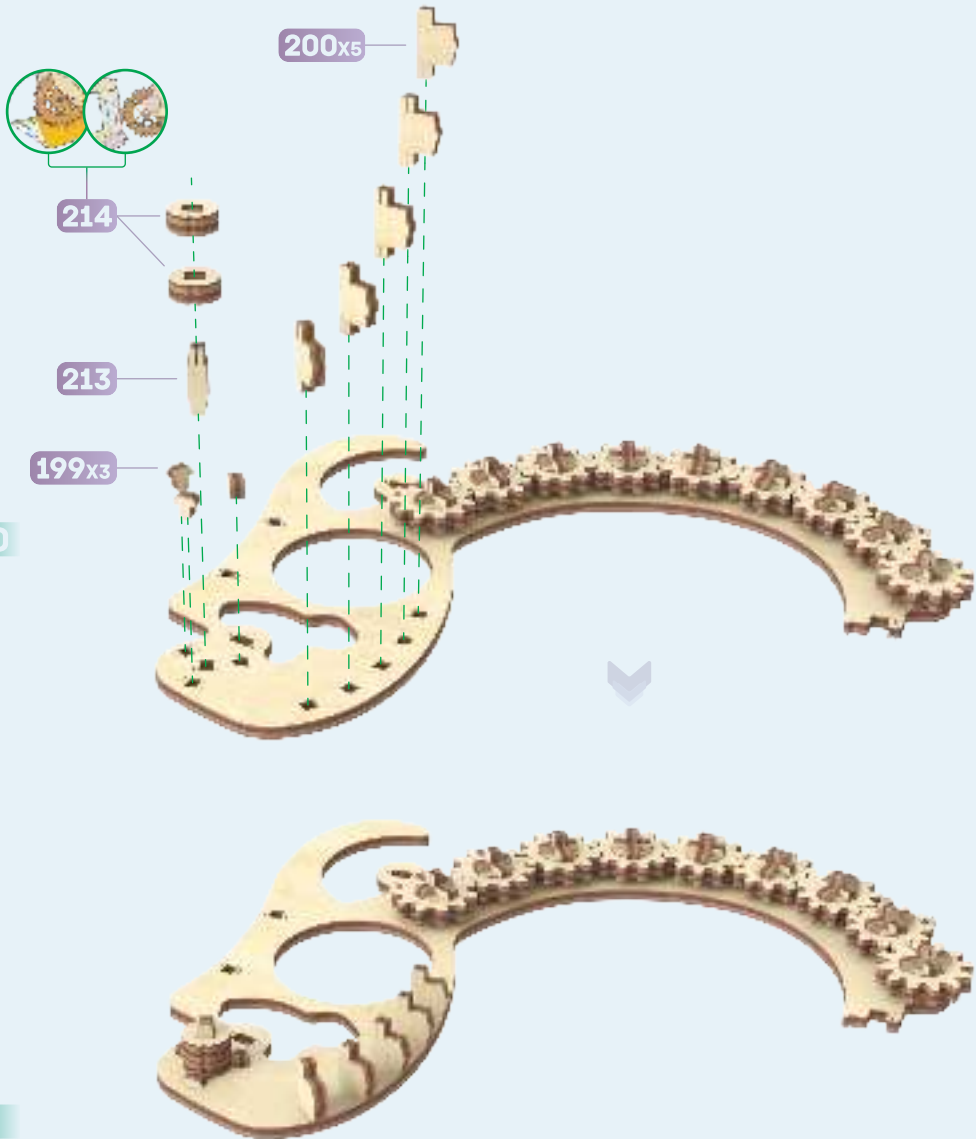

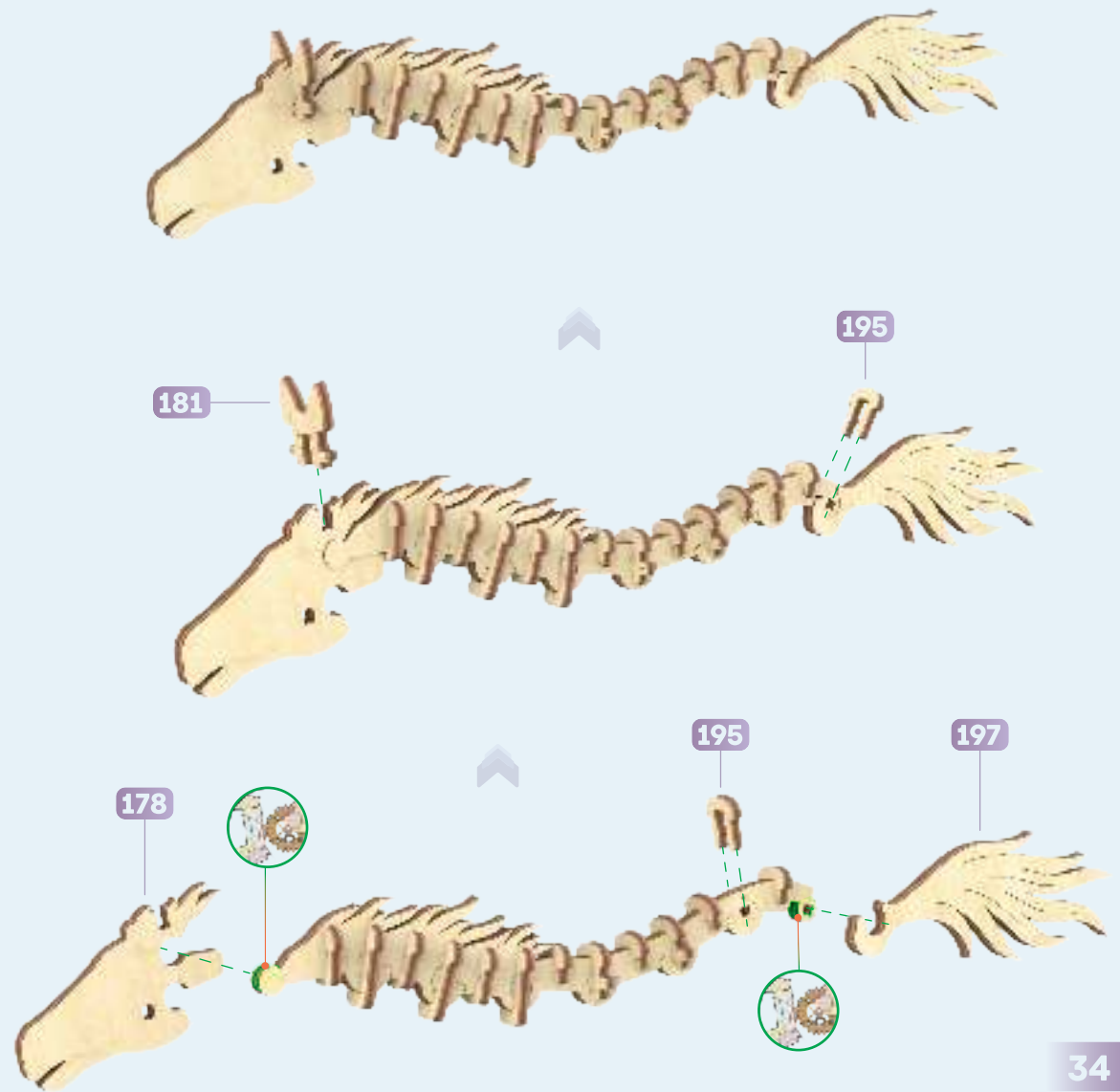

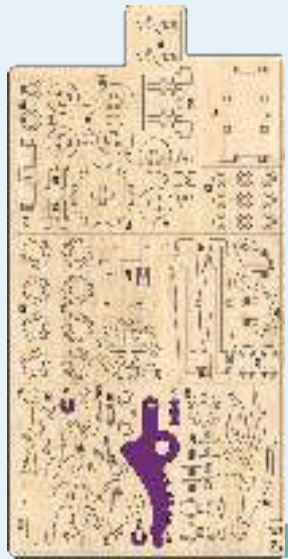

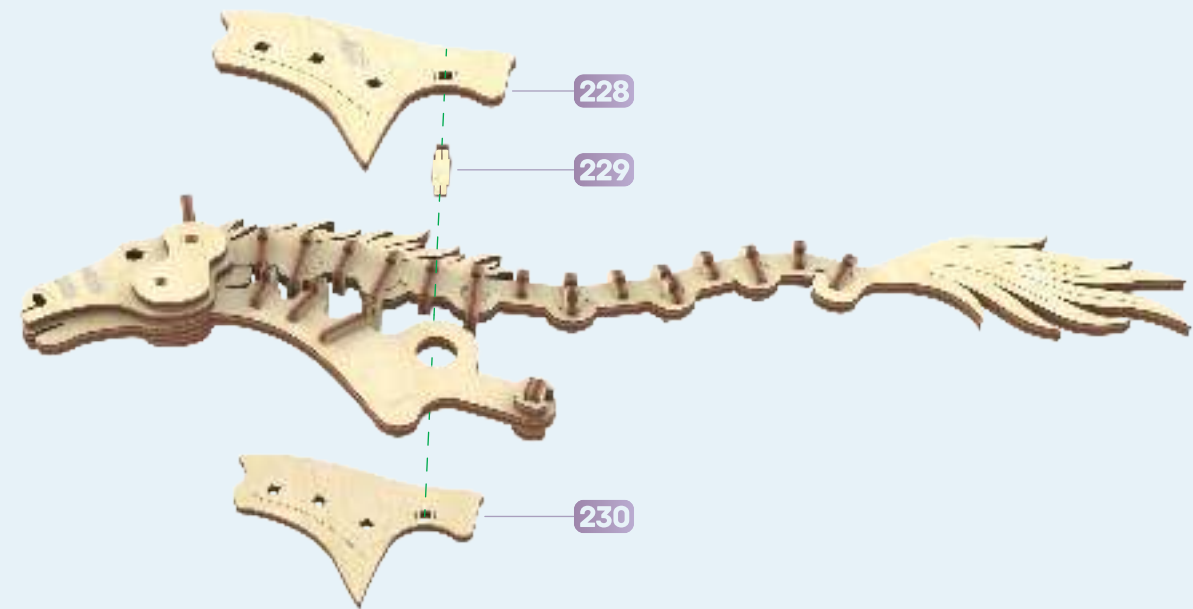
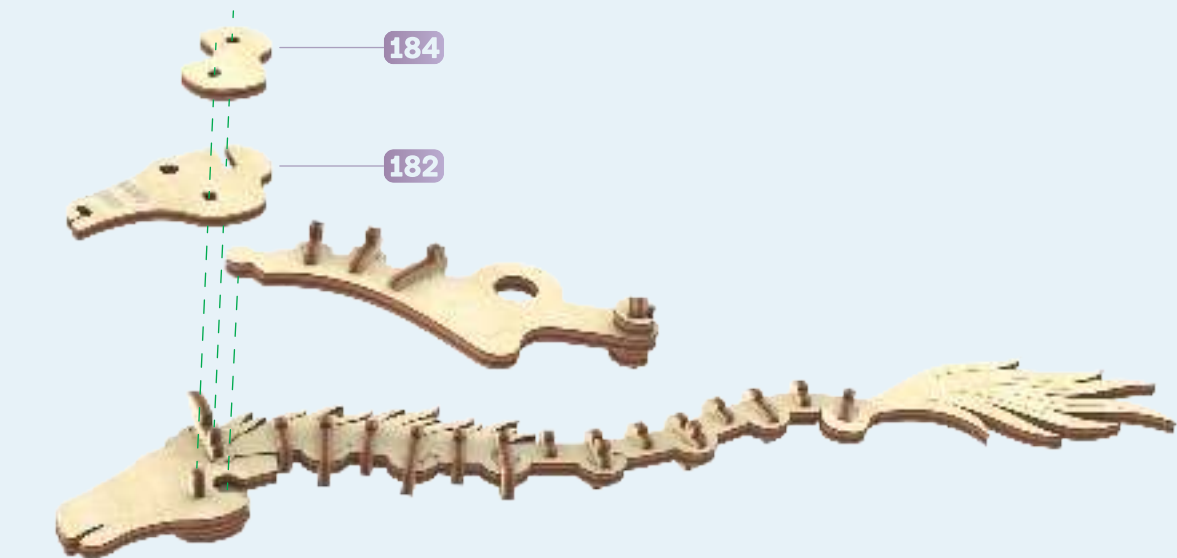

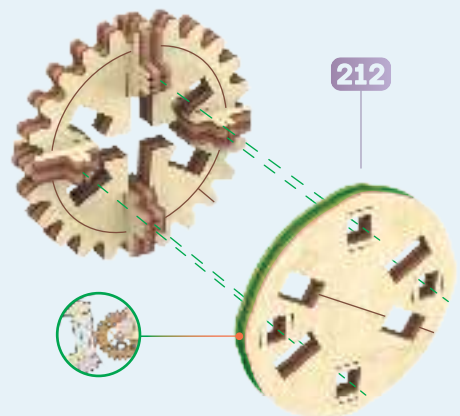
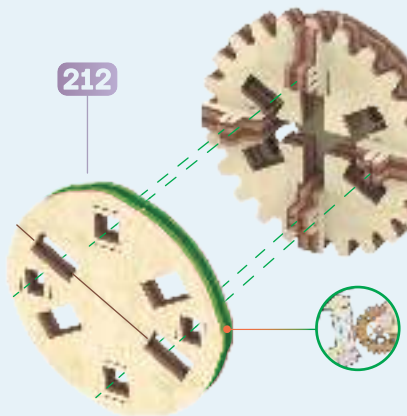
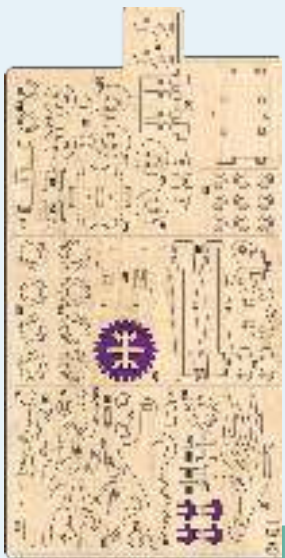
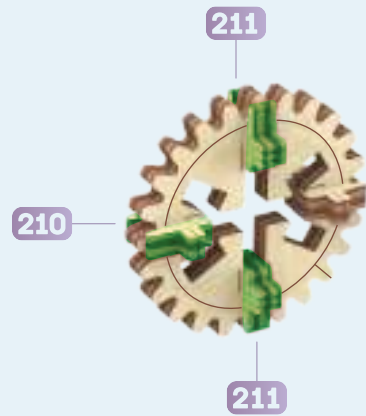
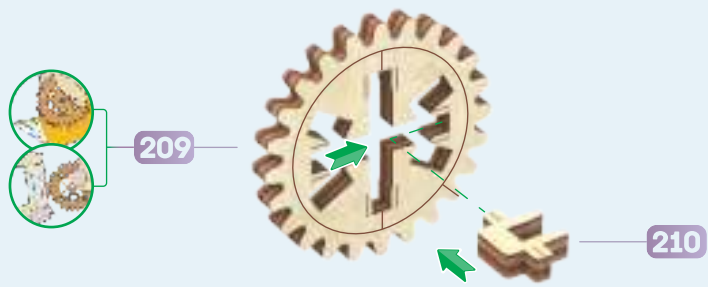



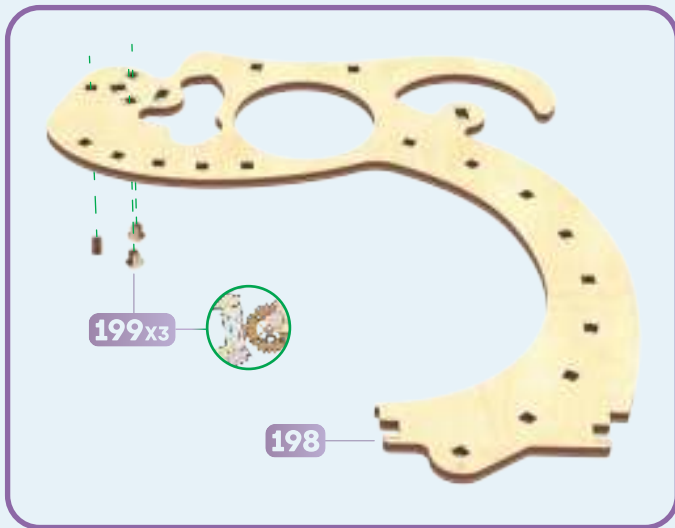

10

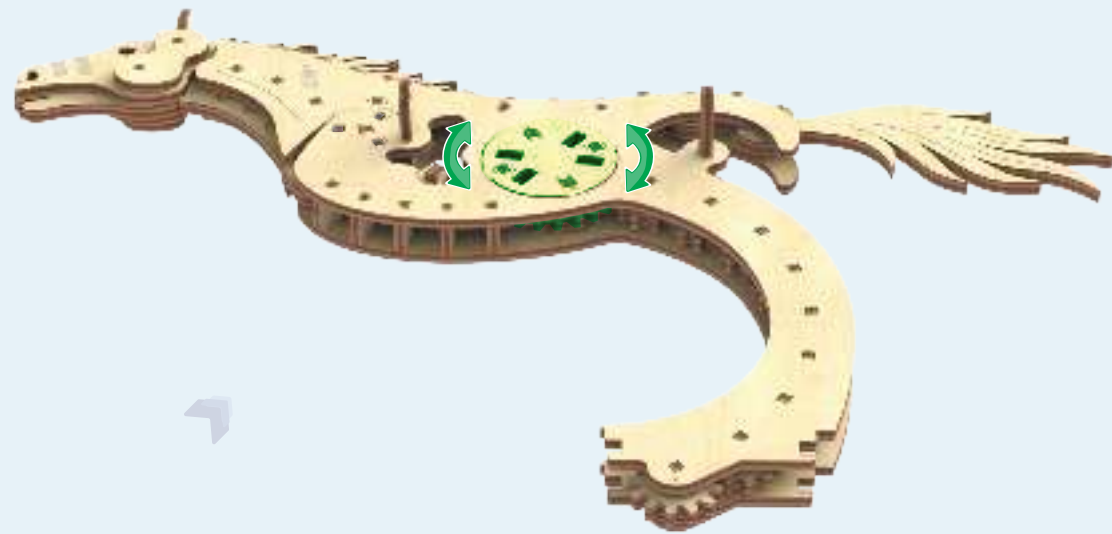
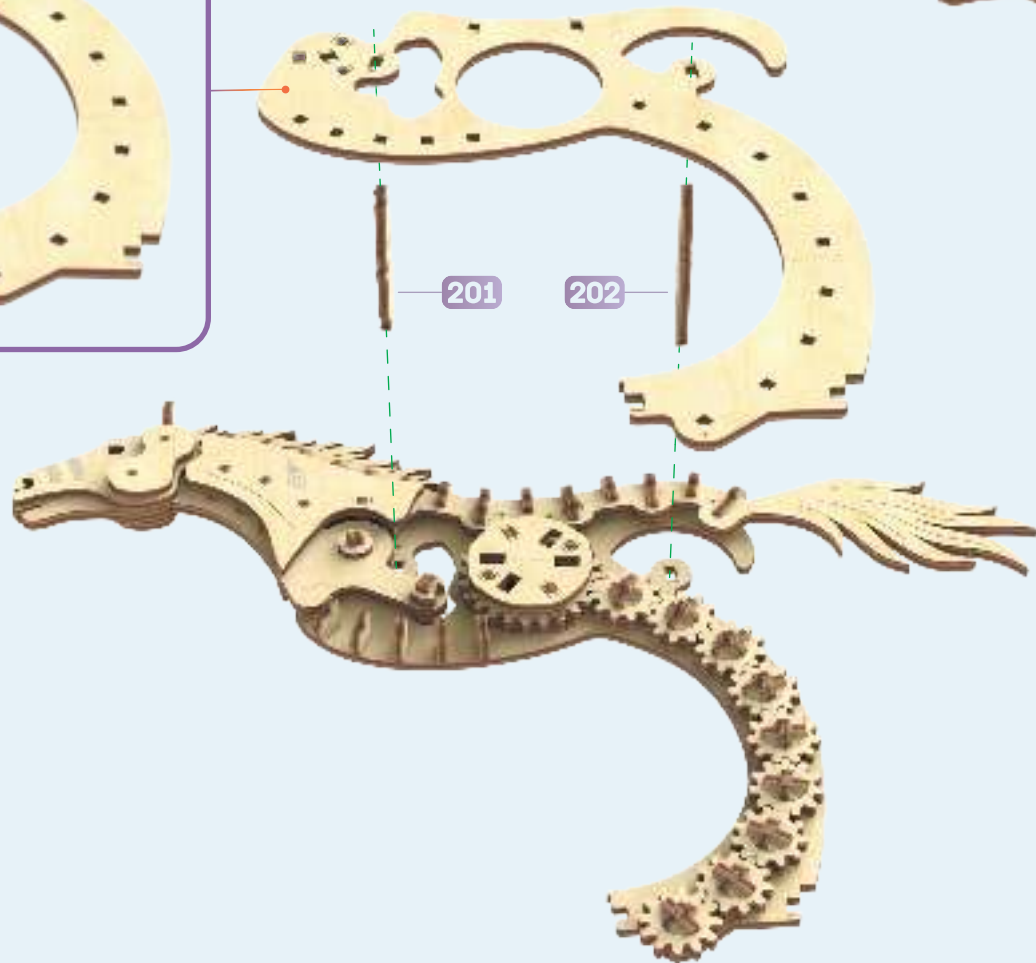

**UA** Розробити механізм за допомогою обертання шестерні у будь-якому напрямку до стану вільного обертання.

**EN** Run the mechanism by rotating the gear in either direction until it rotates freely.

**DE** Einen Mechanismus ausarbeiten, wenn das Zahnrad in jede Richtung gedreht wird, bis es frei ist.

**FR** Faire fonctionner le mécanisme en tournant le pignon dans n'importe quel sens jusqu'à la rotation libre.

**IT** Trattare il meccanismo aiutando la rotazione dell'ingranaggio in qualsiasi direzione verso uno stato di rotazione libera.

**ES** Accione el mecanismo girando el engranje en cualquier dirección hasta que rote libremente.

**PL** Należy uruchomić mechanizm, obracając zębatkę w dowolnym kierunku, aż zacznie się swobodnie obracać.

**JP** 歯車を任意の方向に自由回転状態まで回転させる機構を開発します。



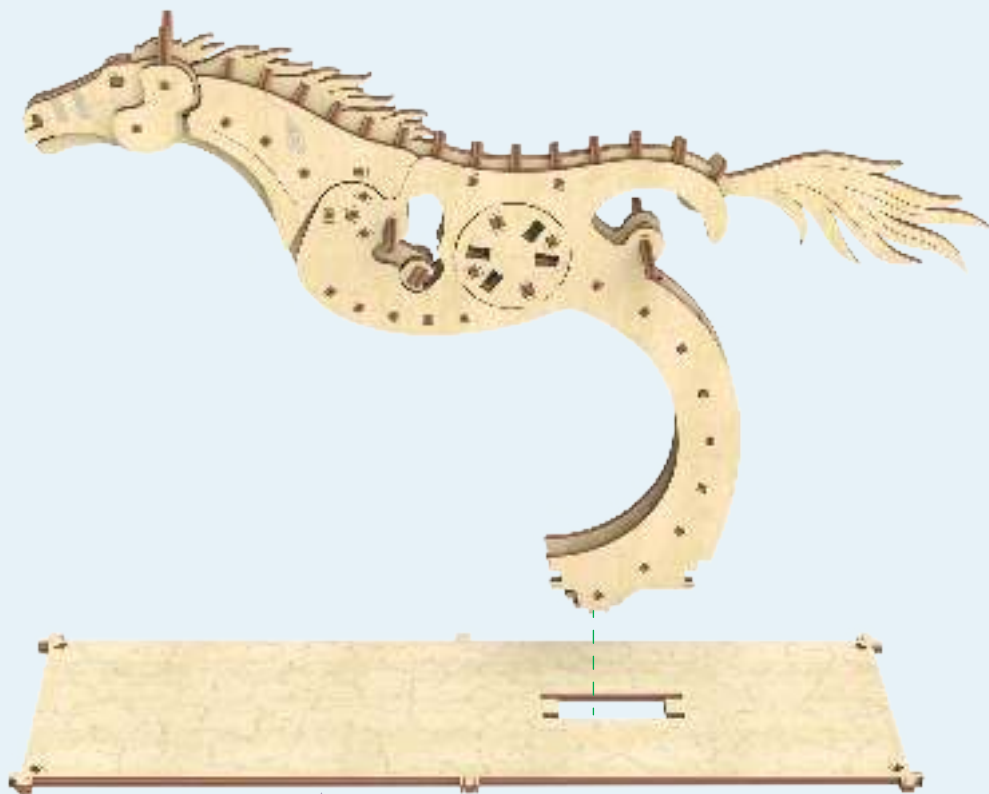
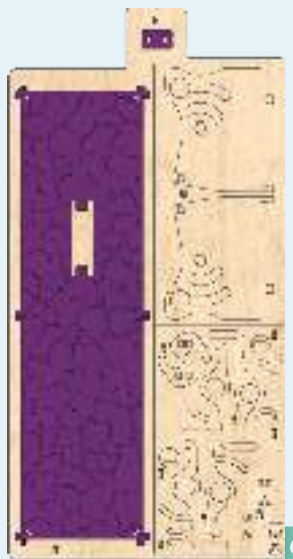

215

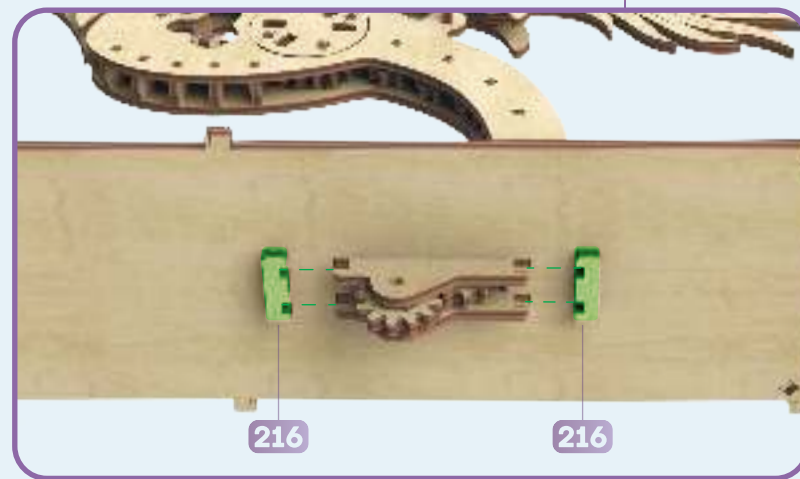

216

216



217

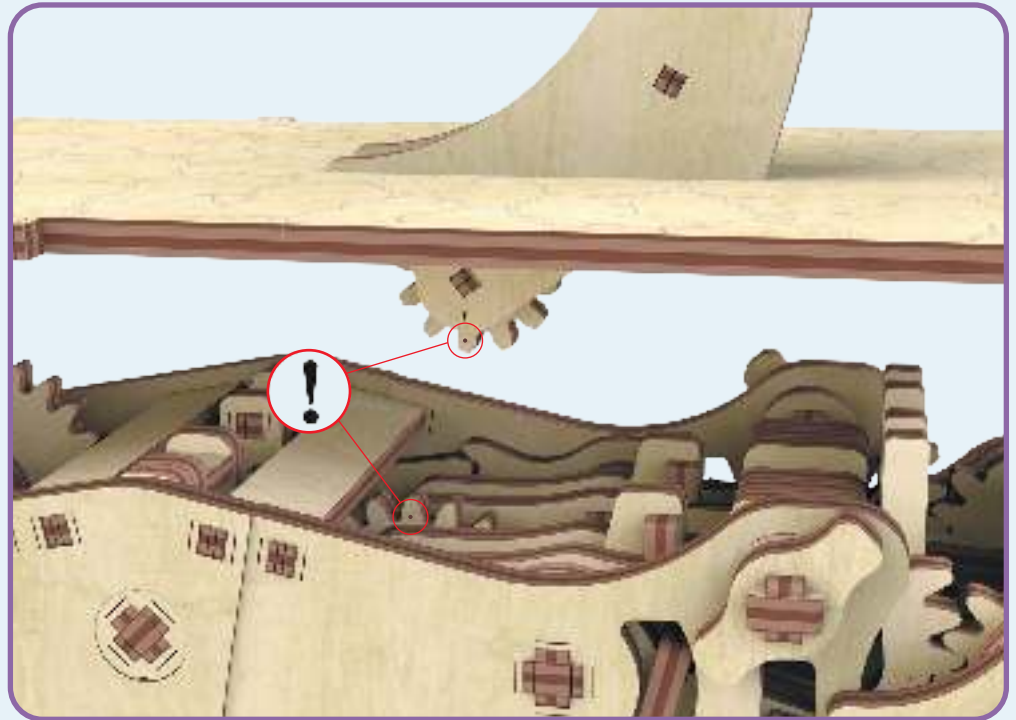
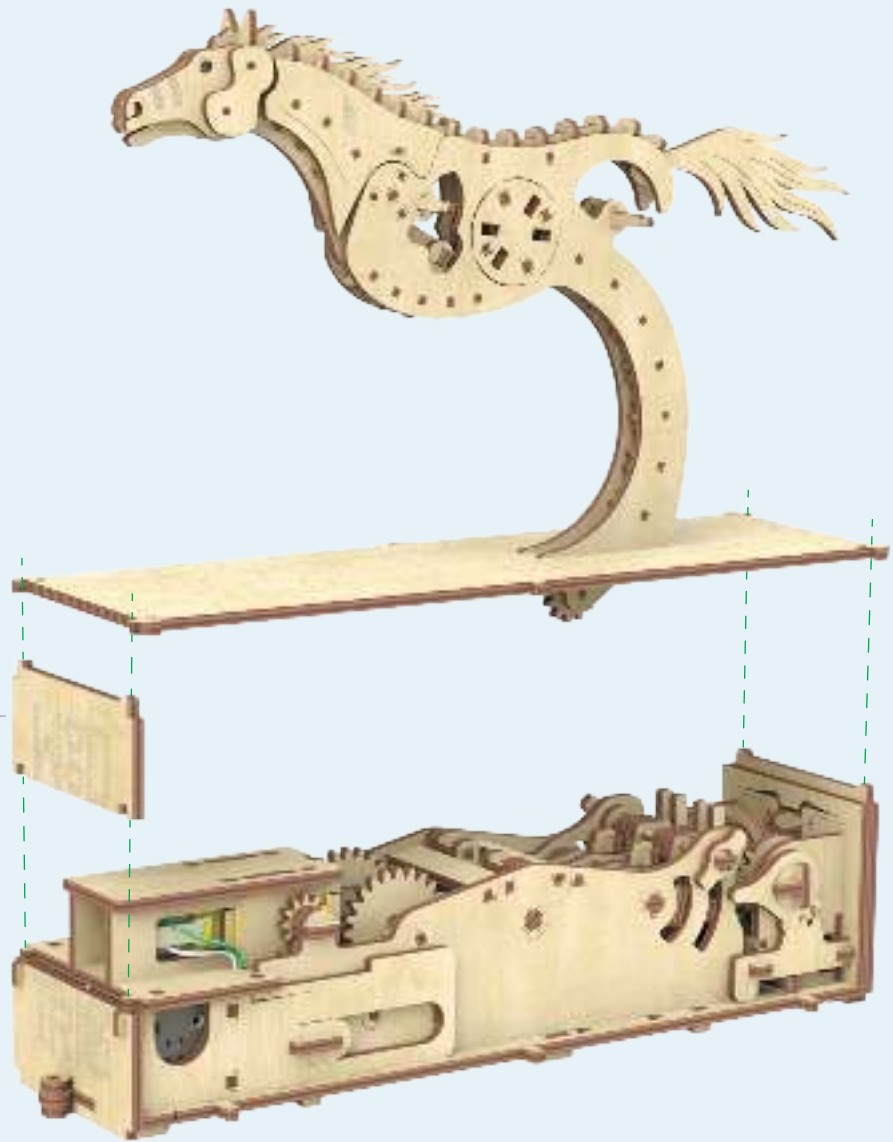

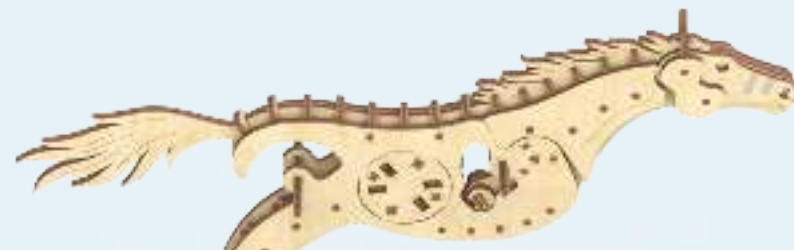

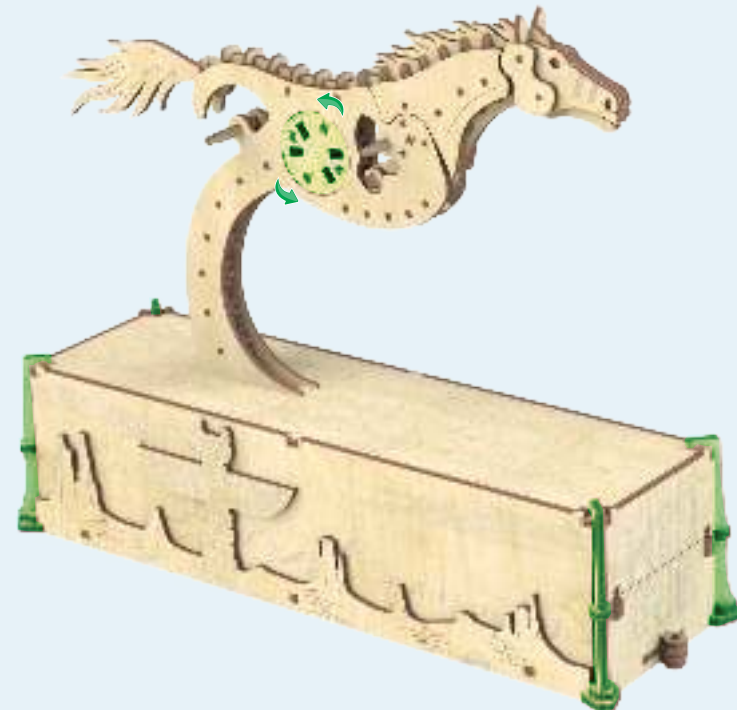
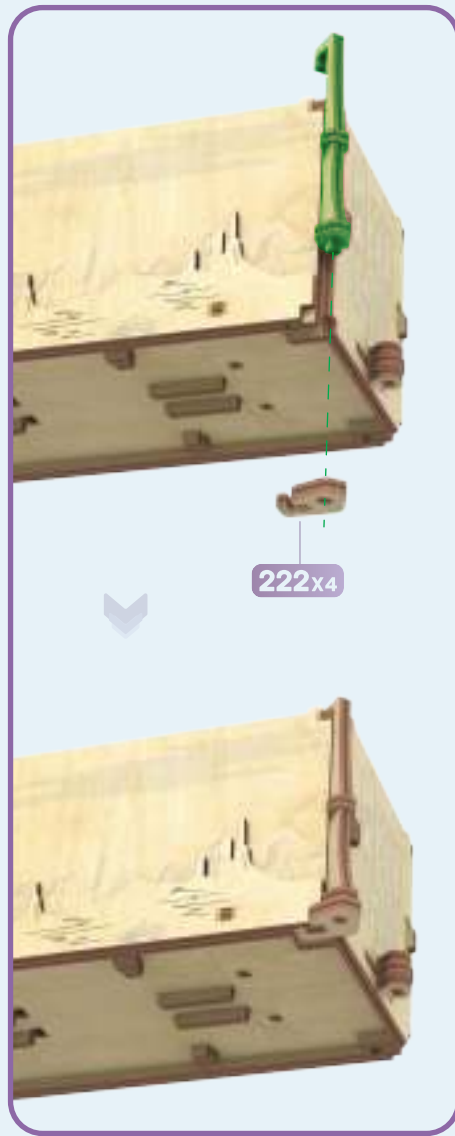
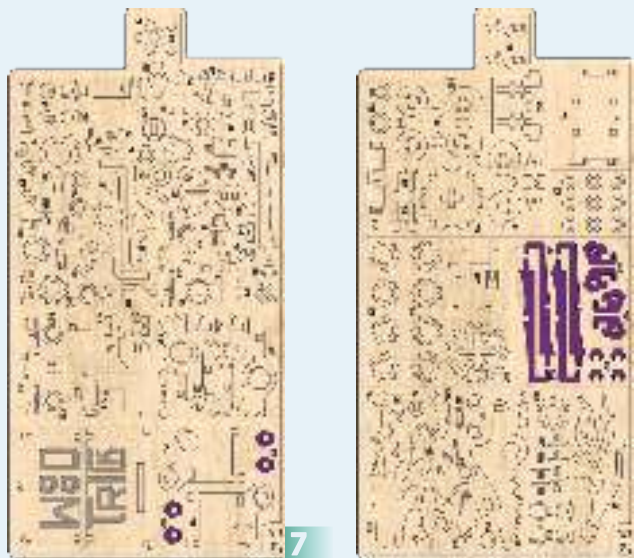

**UA** На цьому етапі необхідно перевірити роботу механізму, увімкніть пристрій у режим "Slow" на 5-10 хвилин. При заклинованні прокручувати руками вказаний вузол у напрямку роботи механізму для його розробки! Не залишати механізм у вимкненому стані при заклинованні більше 10-15 секунд.

**EN** At this point, make sure that the mechanism is operating properly and switch the device to the Slow mode for 5-10 minutes. If stuck, turn the specified assembly manually towards the direction of the mechanism to get it running again! Never leave the mechanism on when stuck for longer than 10-15 seconds.

**DE** In diesem Schritt müssen Sie den Mechanismus überprüfen, schalten Sie das Gerät für 5 bis 10 Minuten in den „Slow“-Modus. Beim Verkleben den angegebenen Knoten mit den Händen in die Arbeitsrichtung des Mechanismus rollen, um ihn zu entwickeln! Lassen Sie den Mechanismus nicht länger als 10 bis 15 Sekunden eingeschaltet, wenn er verklemmt wird.

**FR** A cette étape, il est nécessaire de vérifier le fonctionnement du mécanisme, allumez l'appareil en mode "Slow" pour 5-10 minutes. En cas de blocage, tournez manuellement le bloc indiqué dans le sens du fonctionnement du mécanisme pour sa mise en route! Ne laissez pas le mécanisme en marche en cas de blocage pendant plus de 10-15 secondes.

**IT** In questa fase, è necessario controllare il funzionamento del meccanismo, ruotare il dispositivo in modalità "Slow" per 5-10 minuti. Quando si inceppa, scorrere il nodo specificato con le mani nella direzione del meccanismo per il trattamento! Non lasciare il meccanismo nello stato acceso quando è inceppato per più di 10-15 secondi.

**ES** En este paso, asegúrese de que el mecanismo funciona correctamente y active el modo Slow para unos 5-10 minutos. Si se bloquea, gire manualmente el conjunto especificado hacia la dirección del mecanismo para que vuelva a funcionar. No deje nunca el mecanismo accionado cuando esté bloqueado durante más de 10-15 segundos.

**PL** Na tym etapie należy sprawdzić działanie mechanizmu, włączając urządzenie w trybie "Slow" na 5-10 minut. W przypadku zacięcia należy ręcznie obrócić wskazany zespół w kierunku mechanizmu, aby go rozruszać! Nie pozostawiaj włączonego mechanizmu w przypadku zacięcia dłużej niż 10-15 sekund.

**JP** この段階では、機構の動作を確認し、「低速」モードで5～10分間デバイスの電源を入れます。ジャムの場合は、表示されたアセンブリをメカニズムの方向に手でスクロールして展開します。詰まりが発生した場合、機構を10～15秒以上オンのままにしないでください。

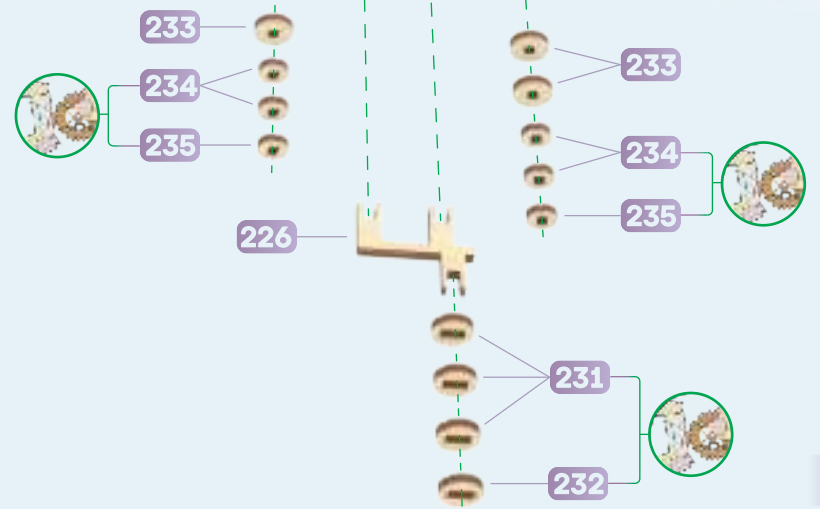
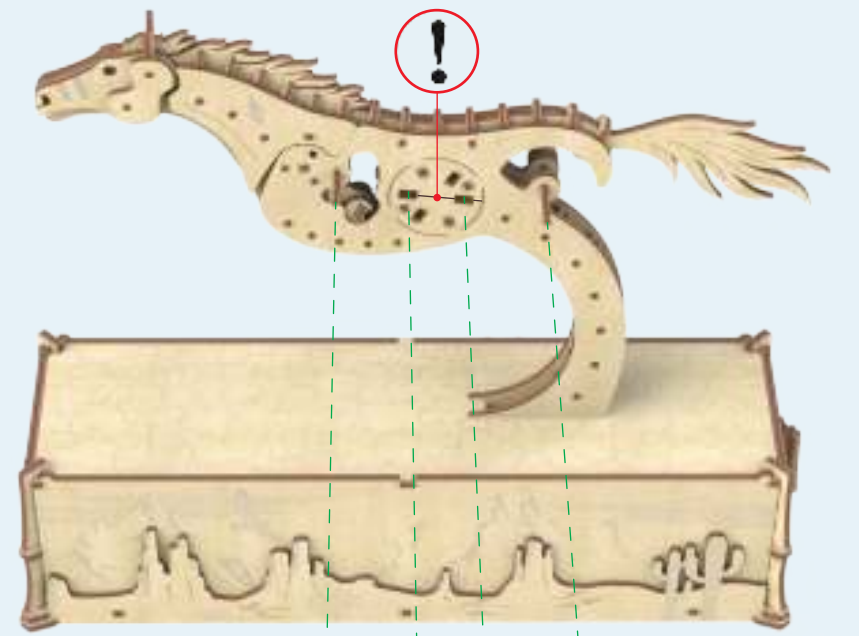
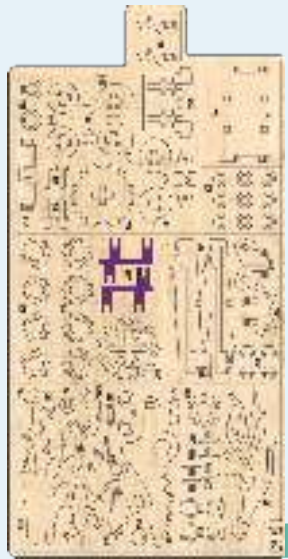
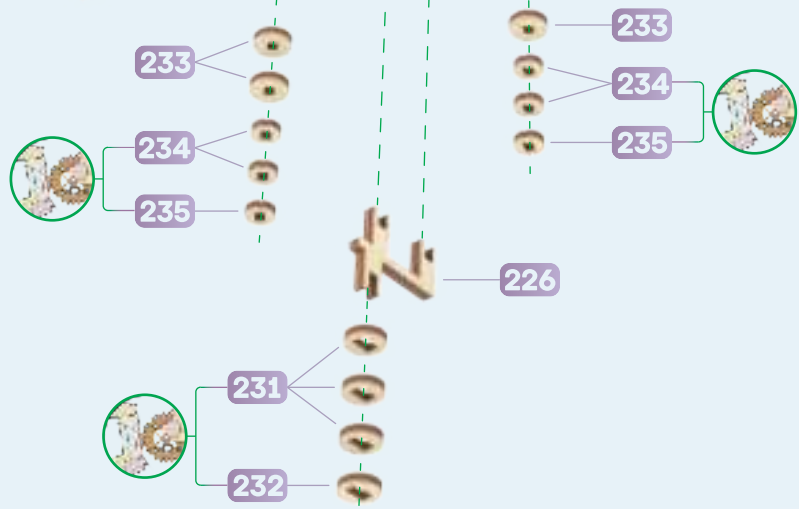
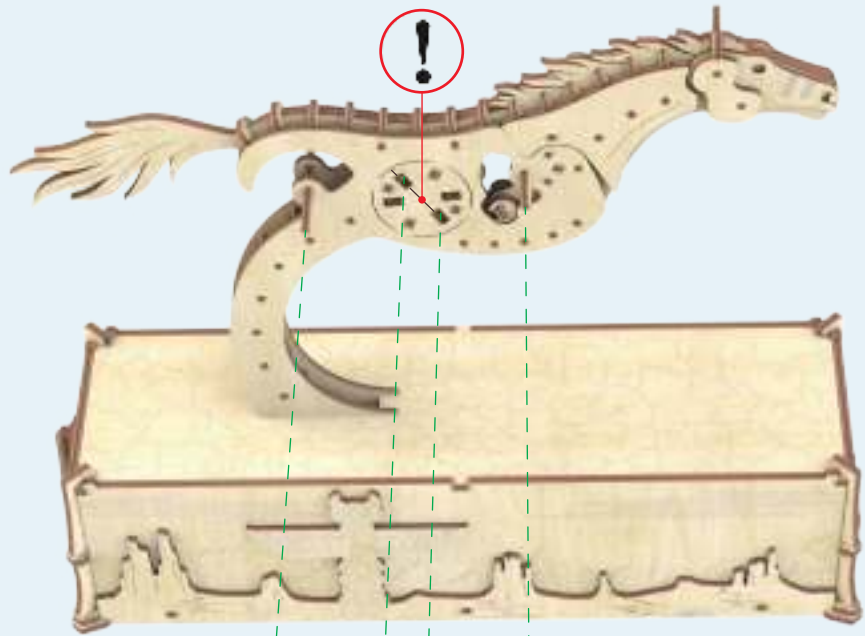



10



11



9

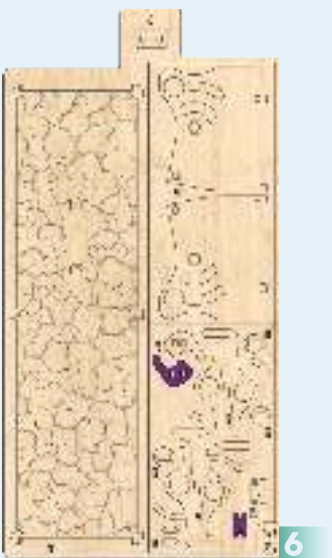

6

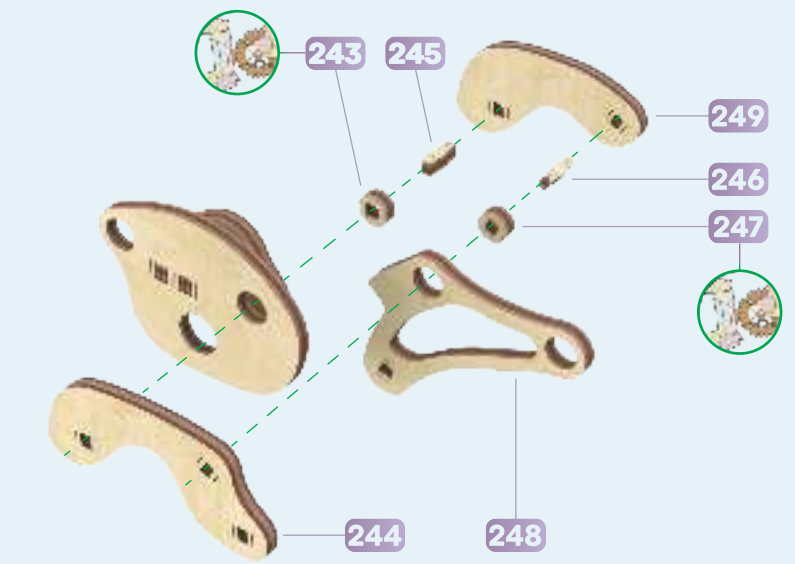
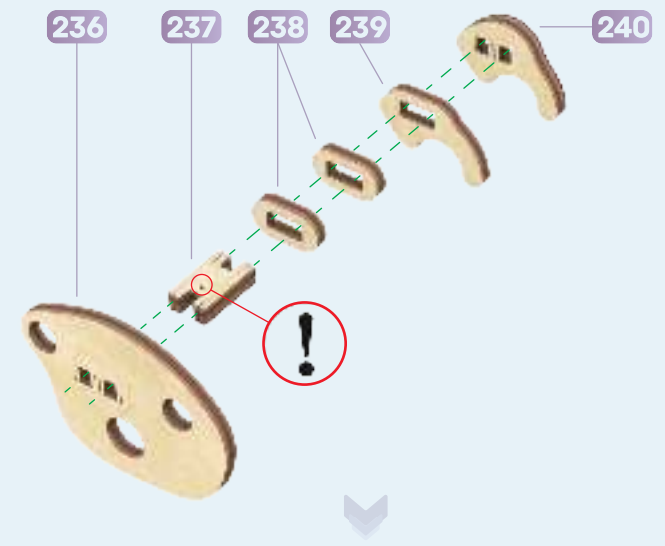
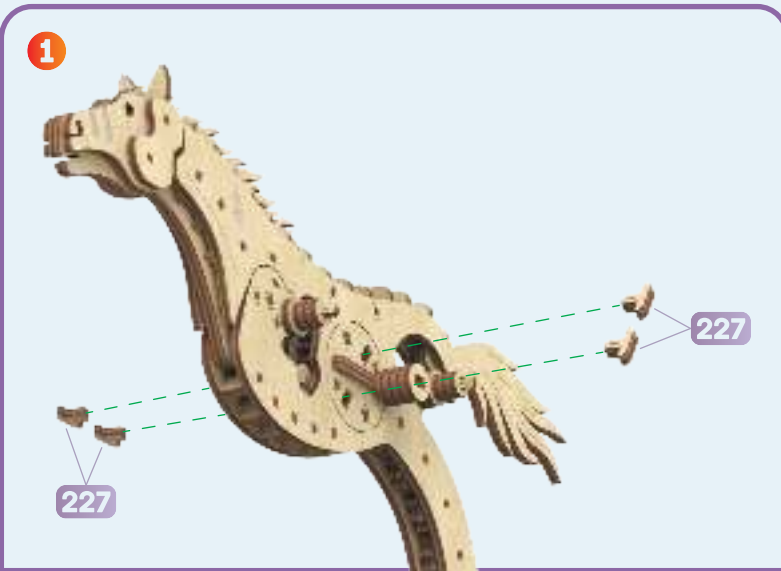

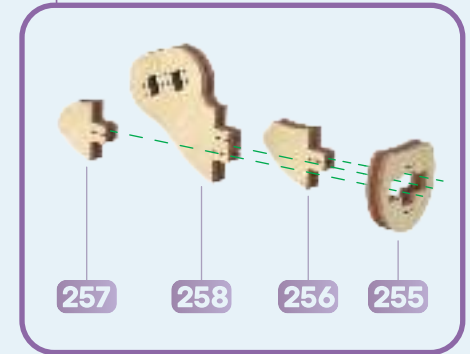
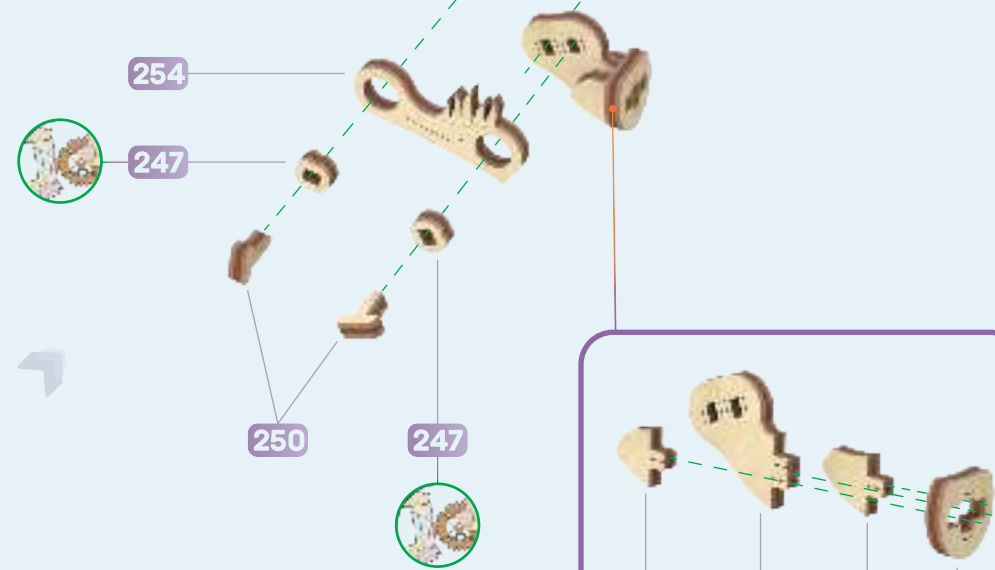
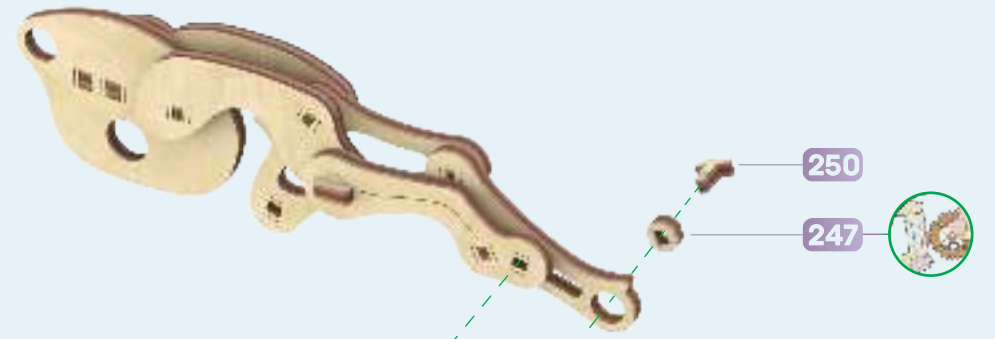
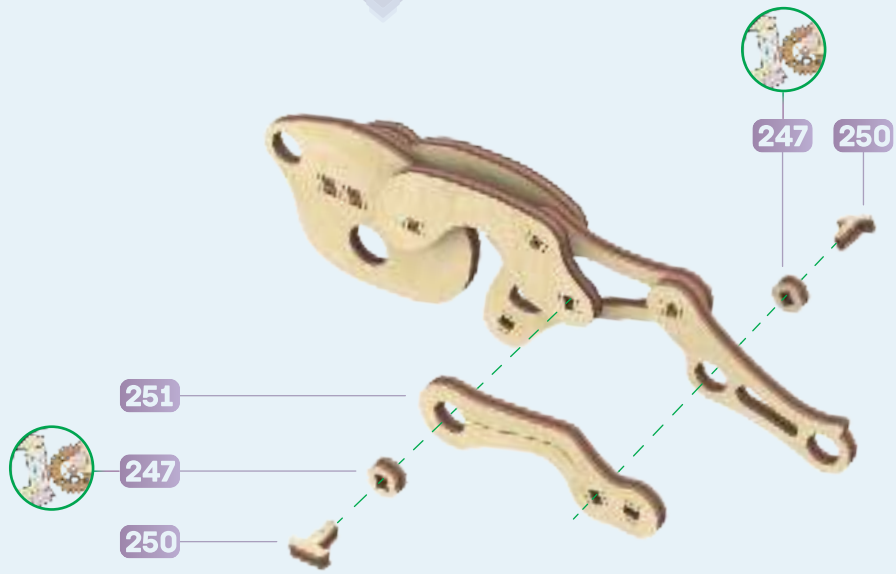
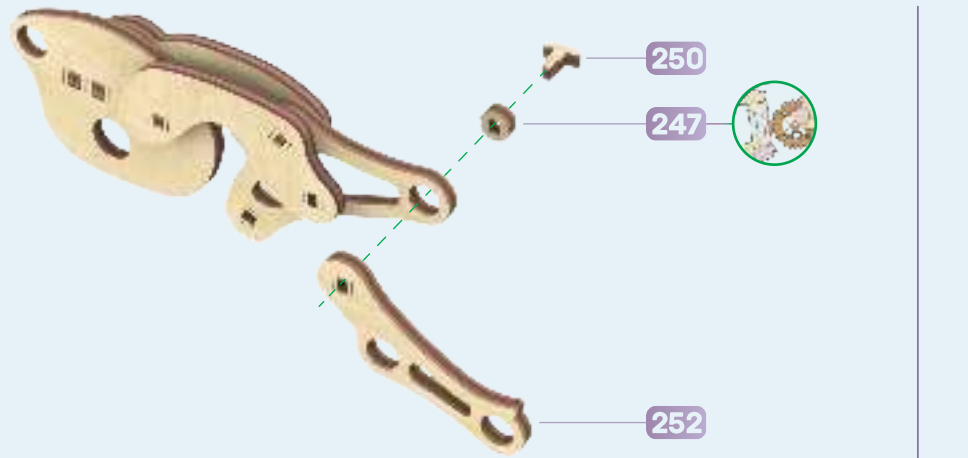

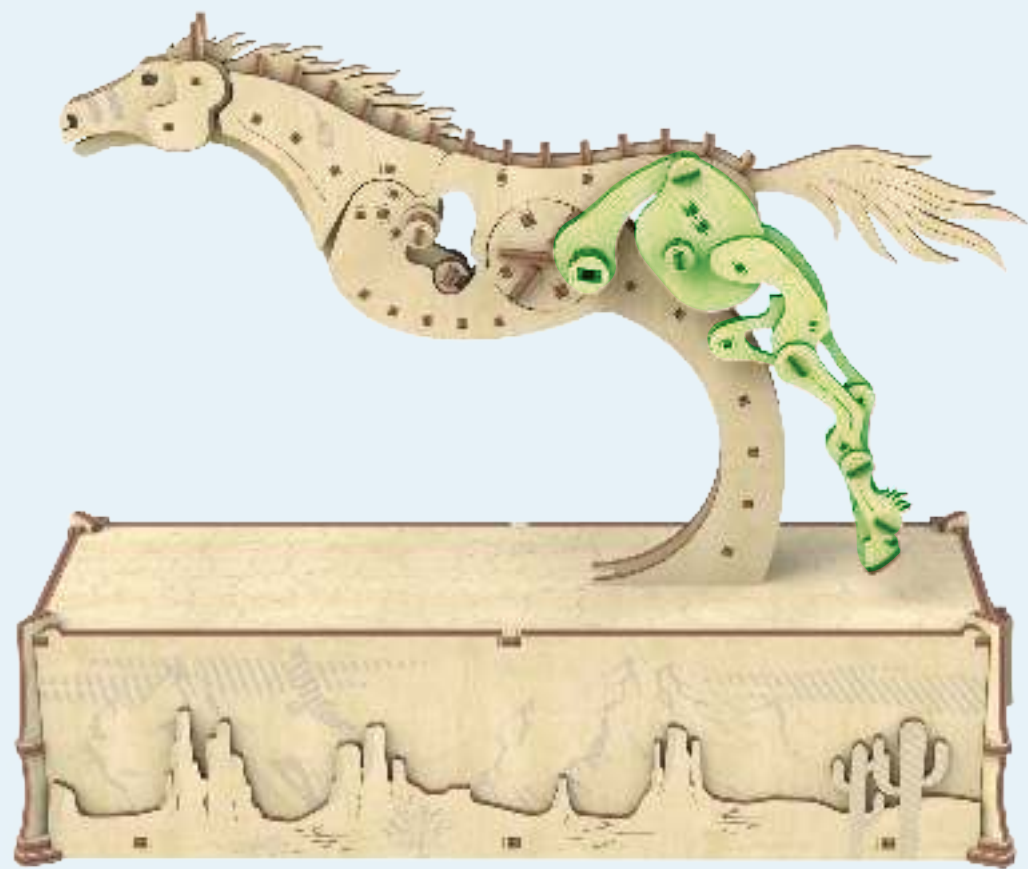



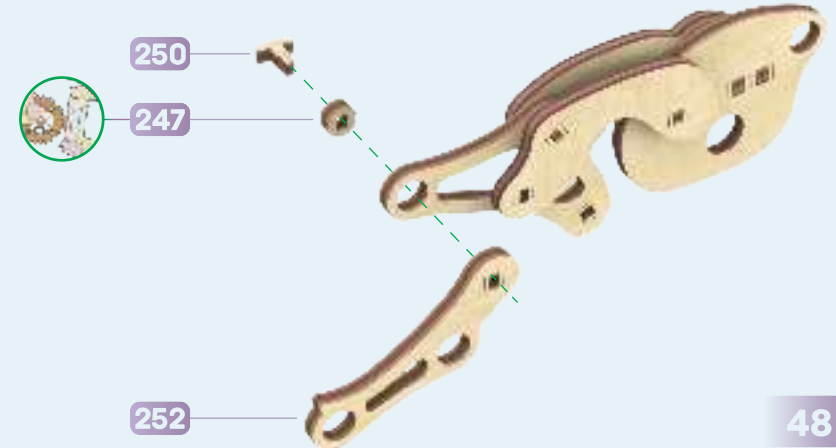
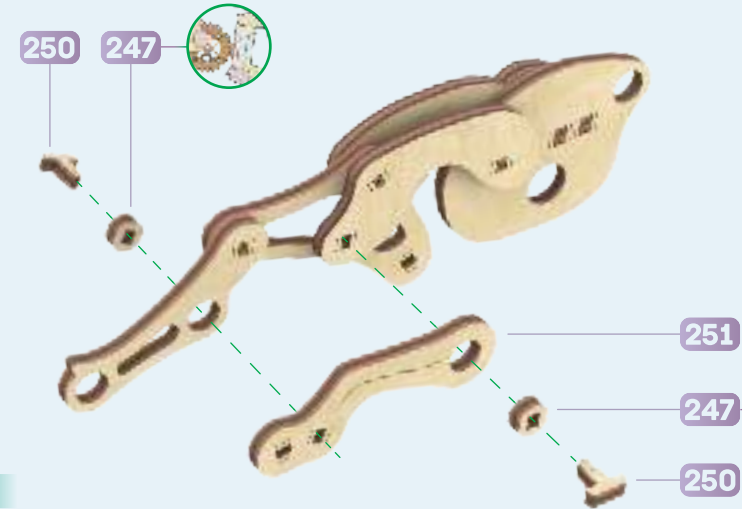
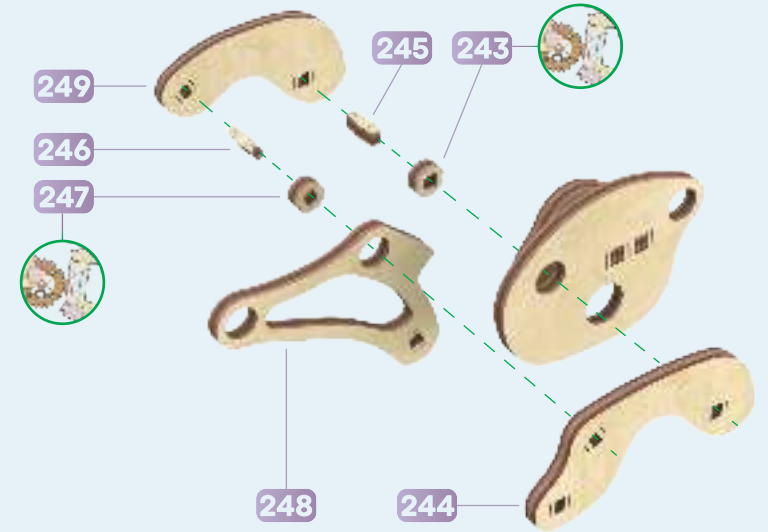
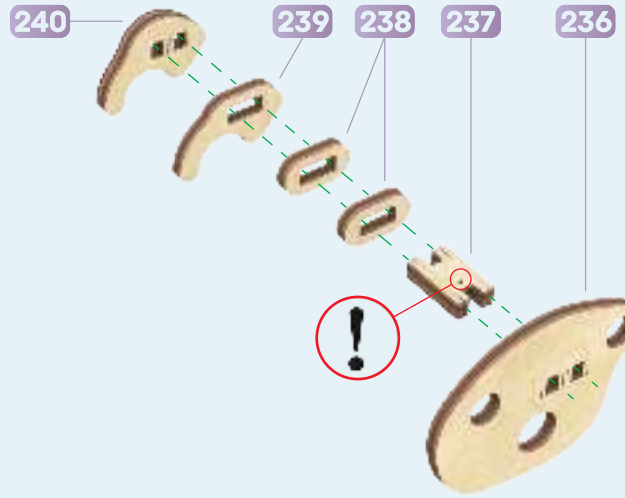

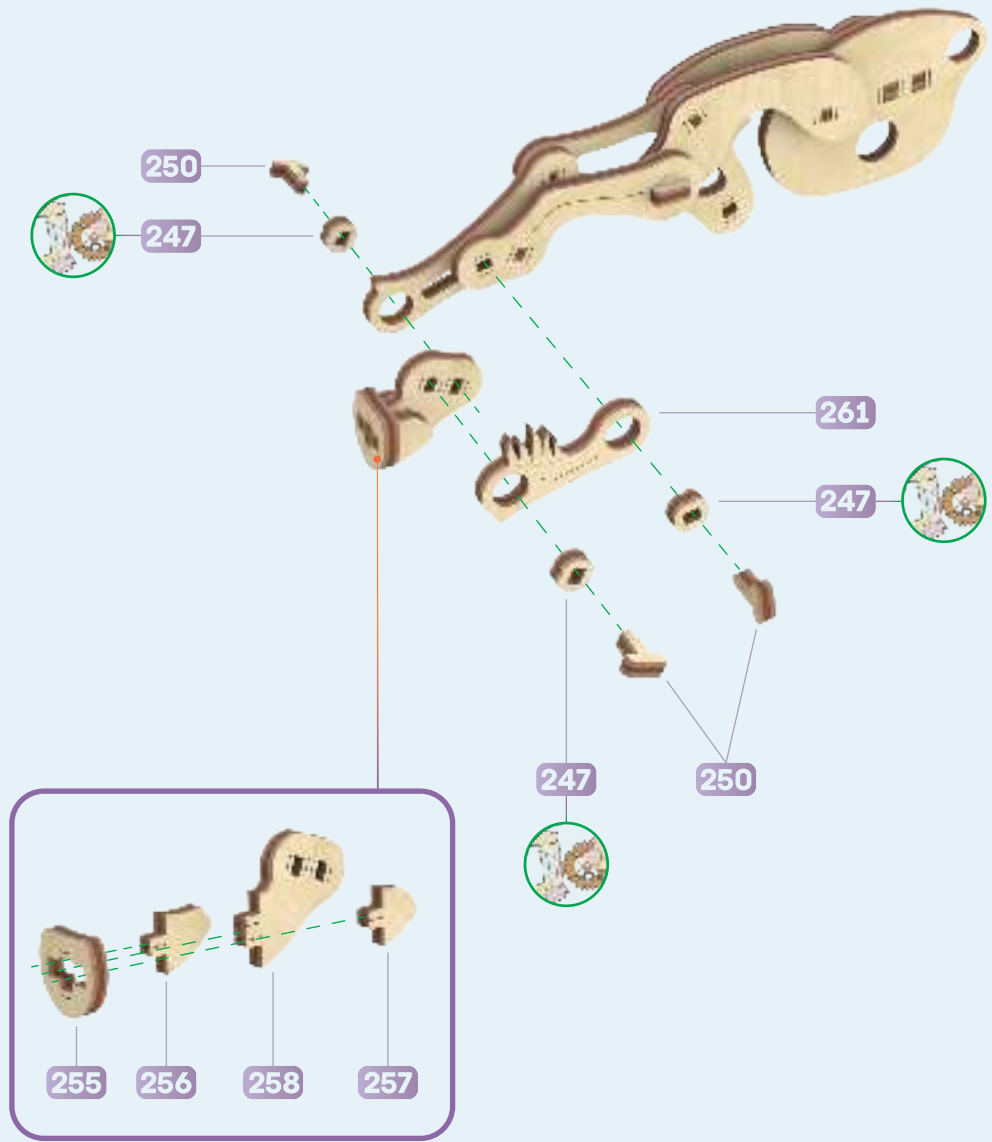

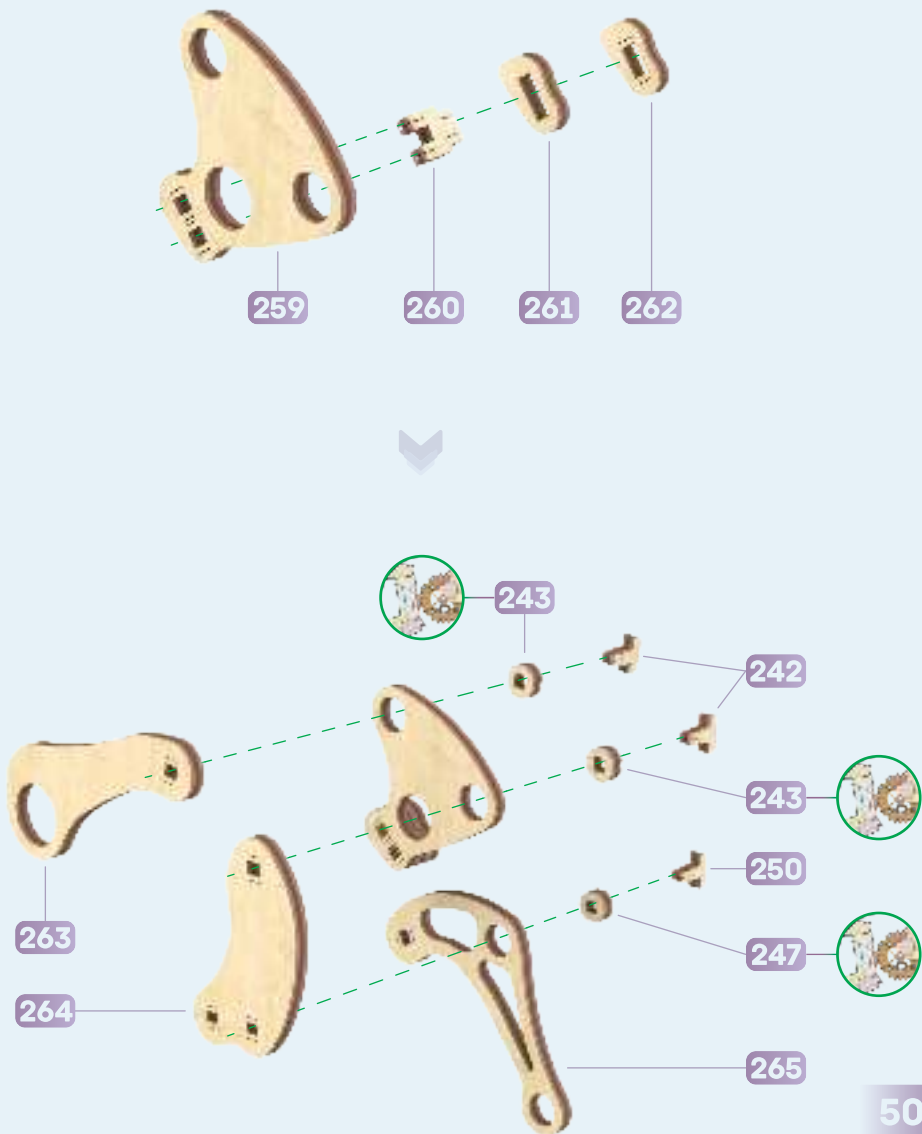
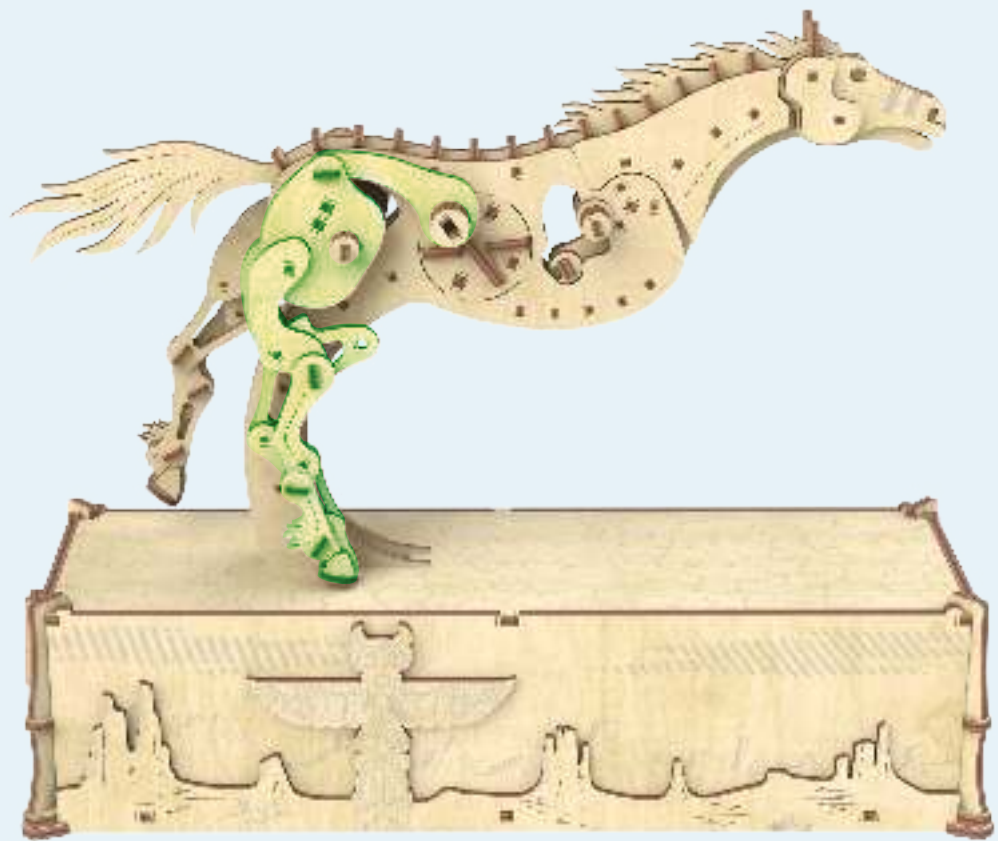

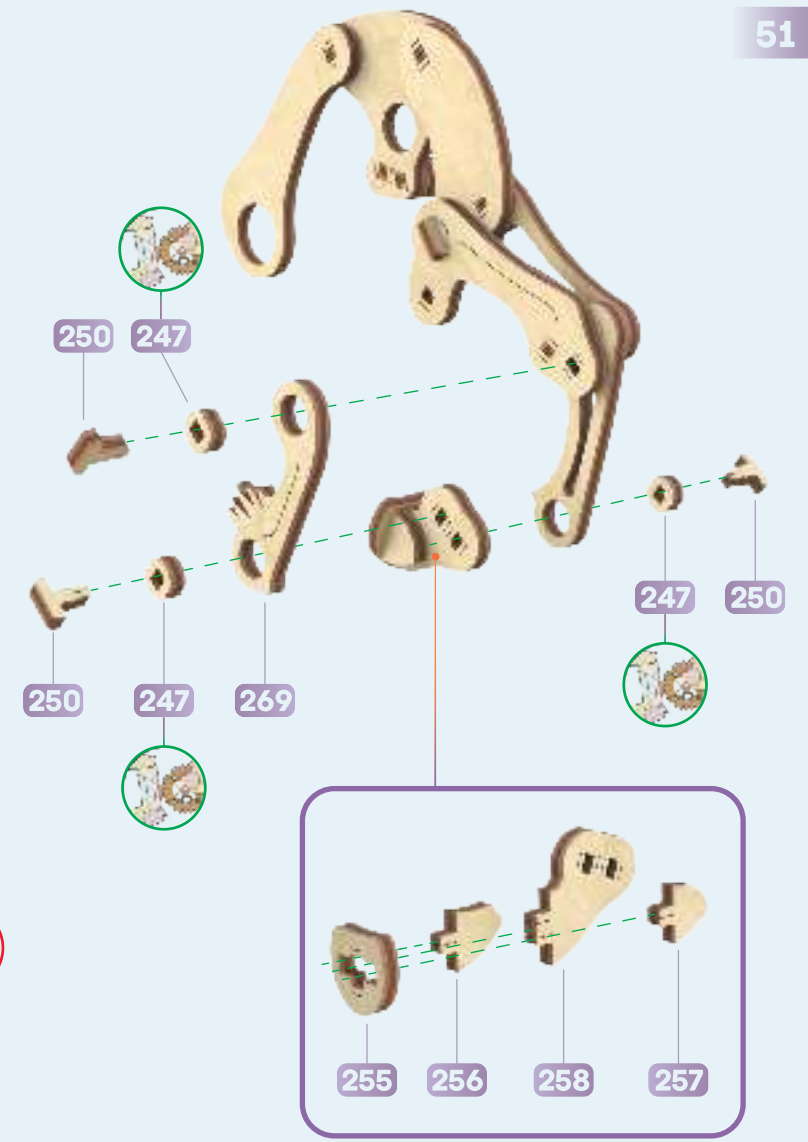
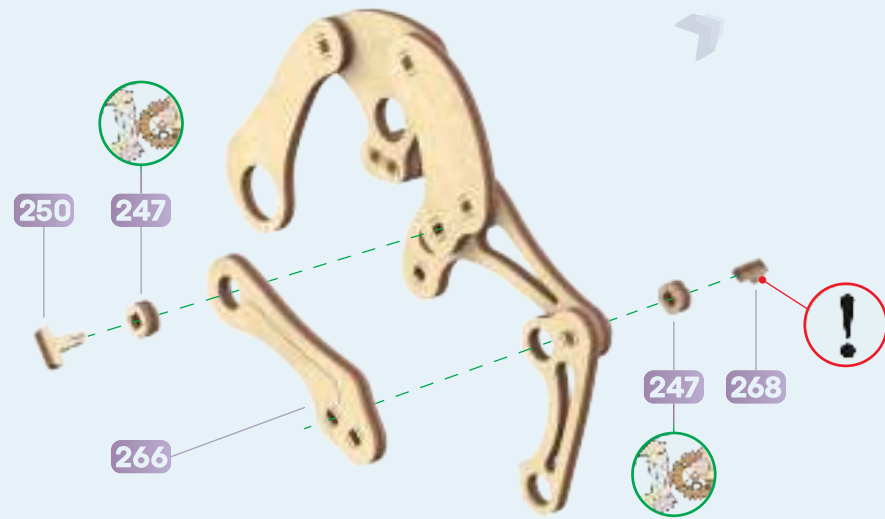

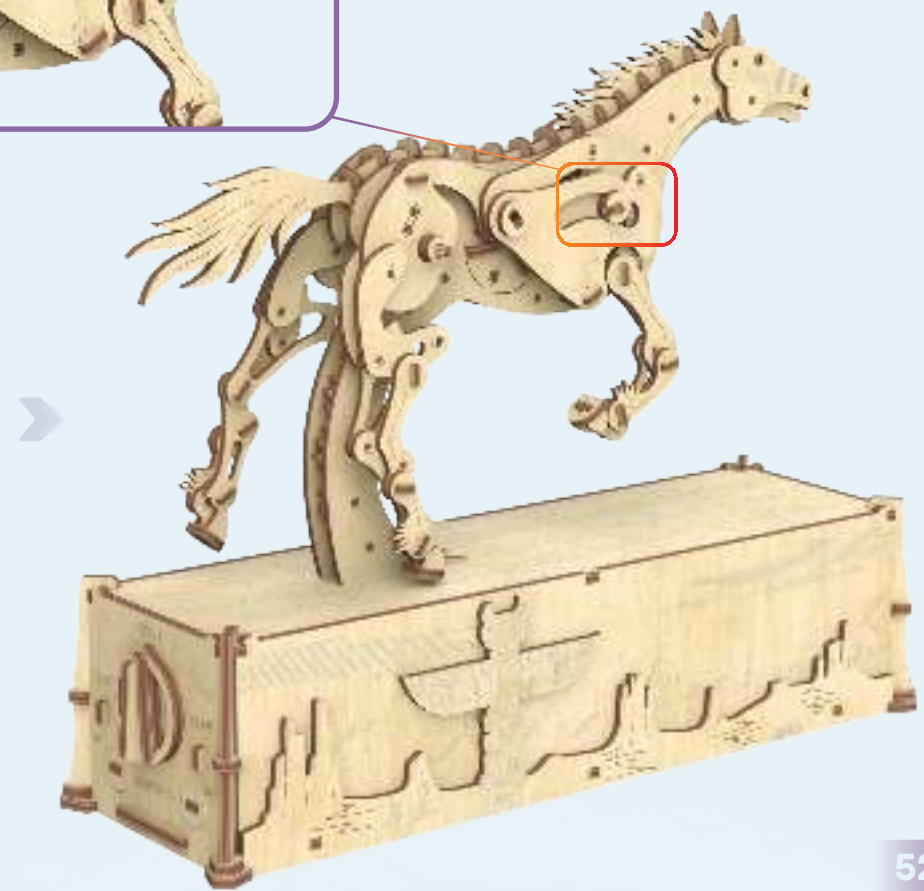
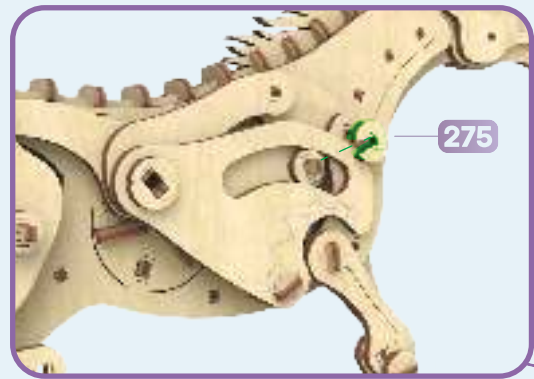
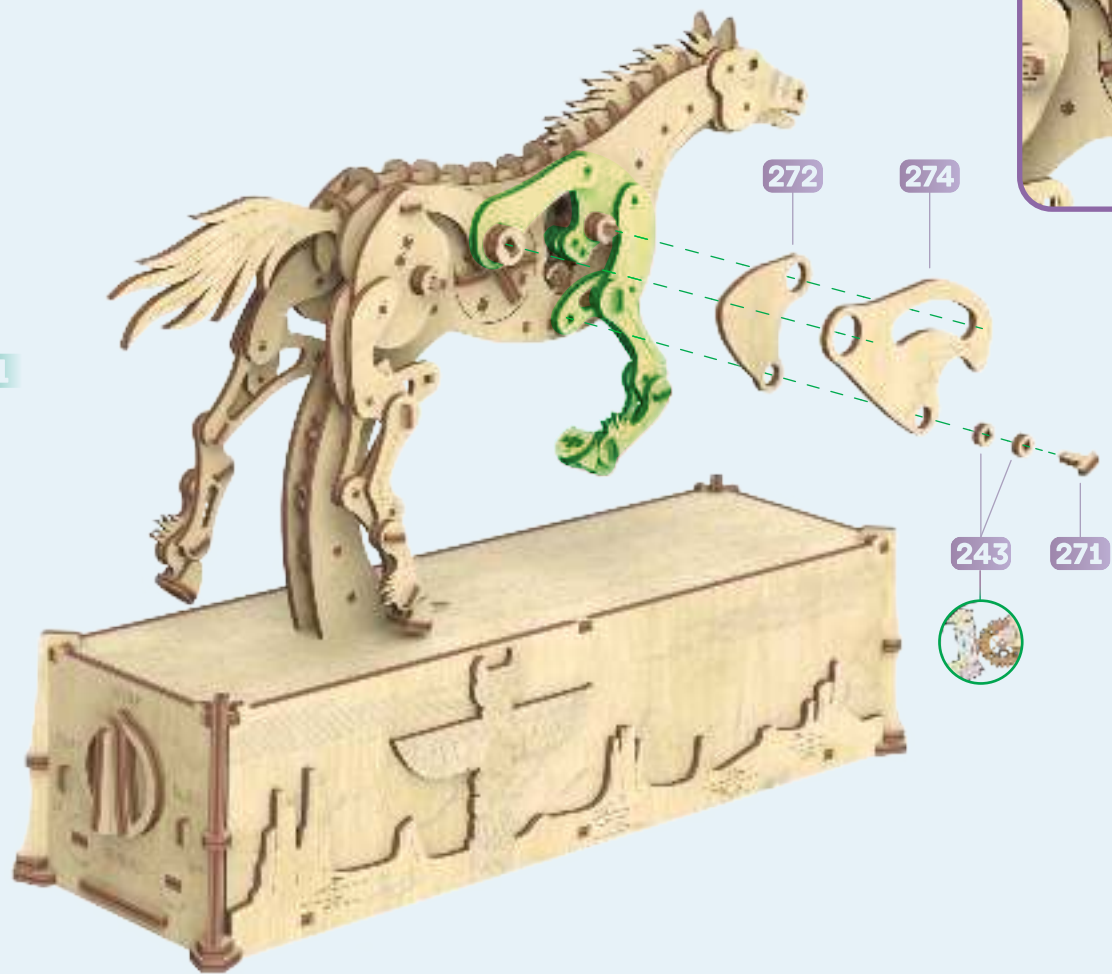

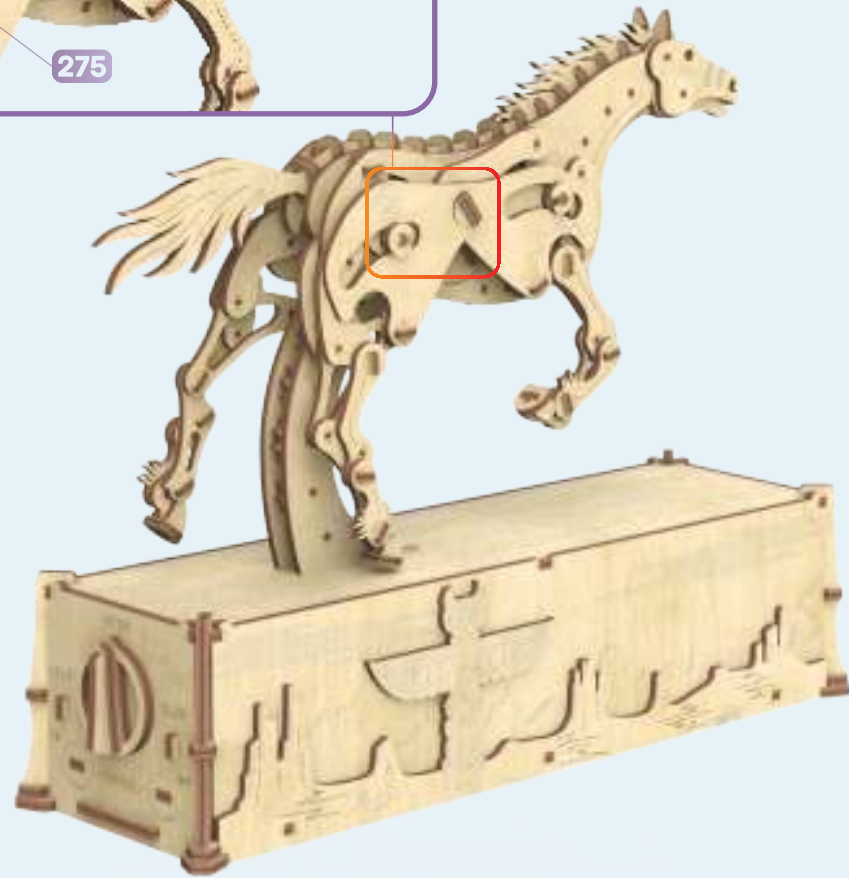
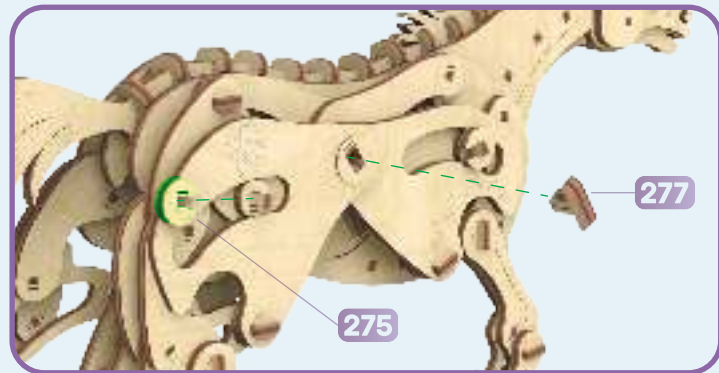
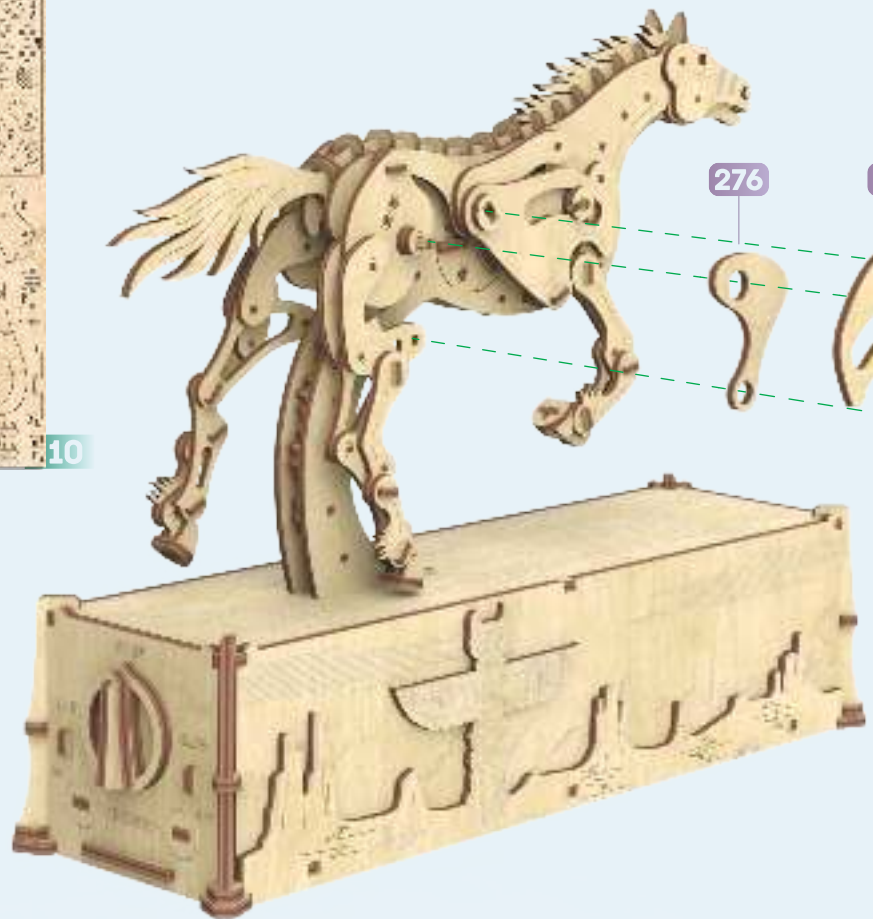

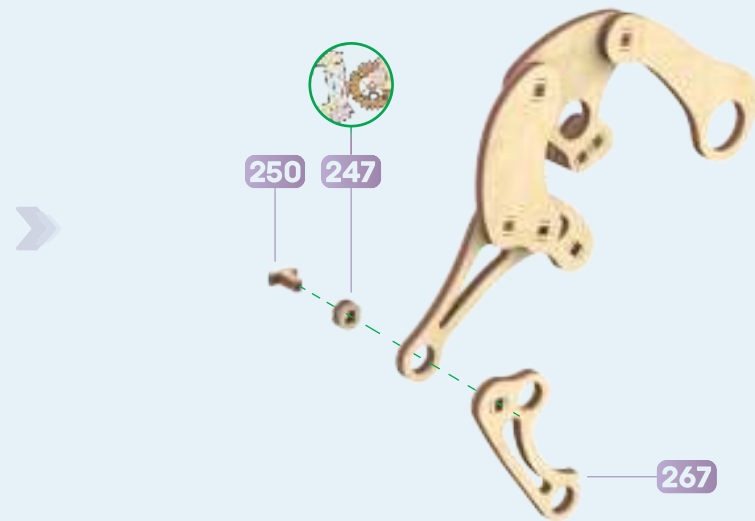
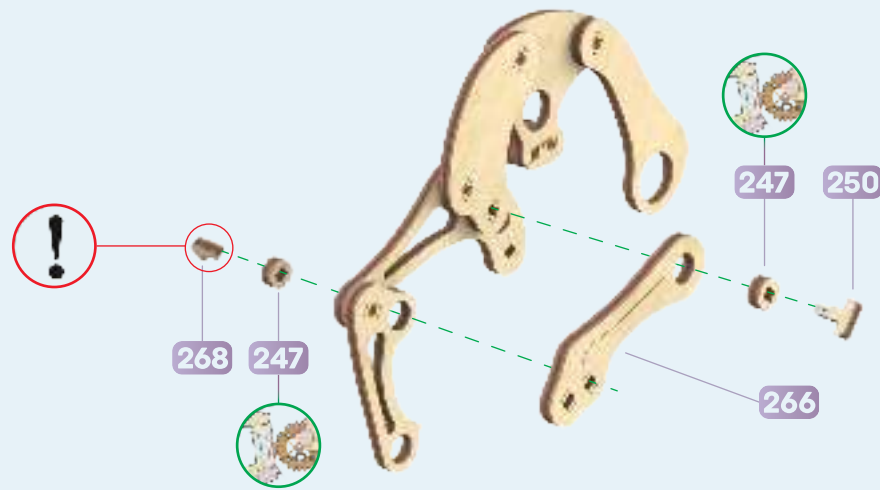
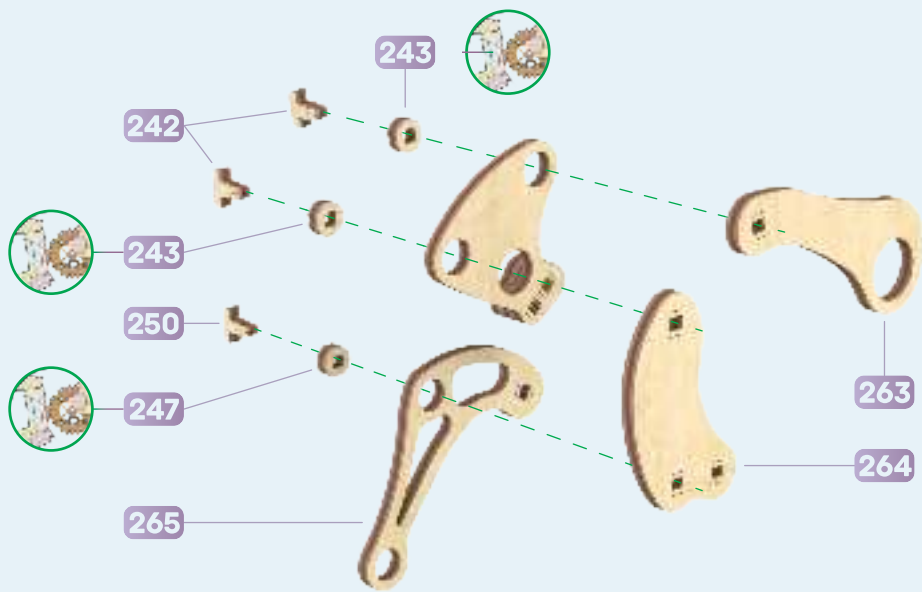
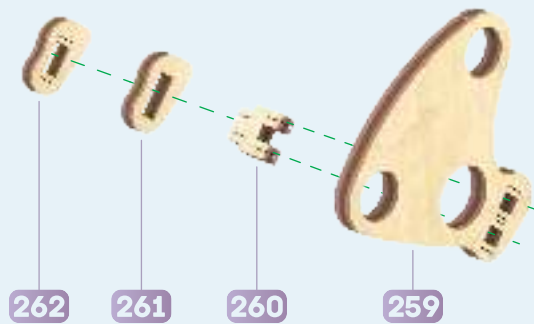

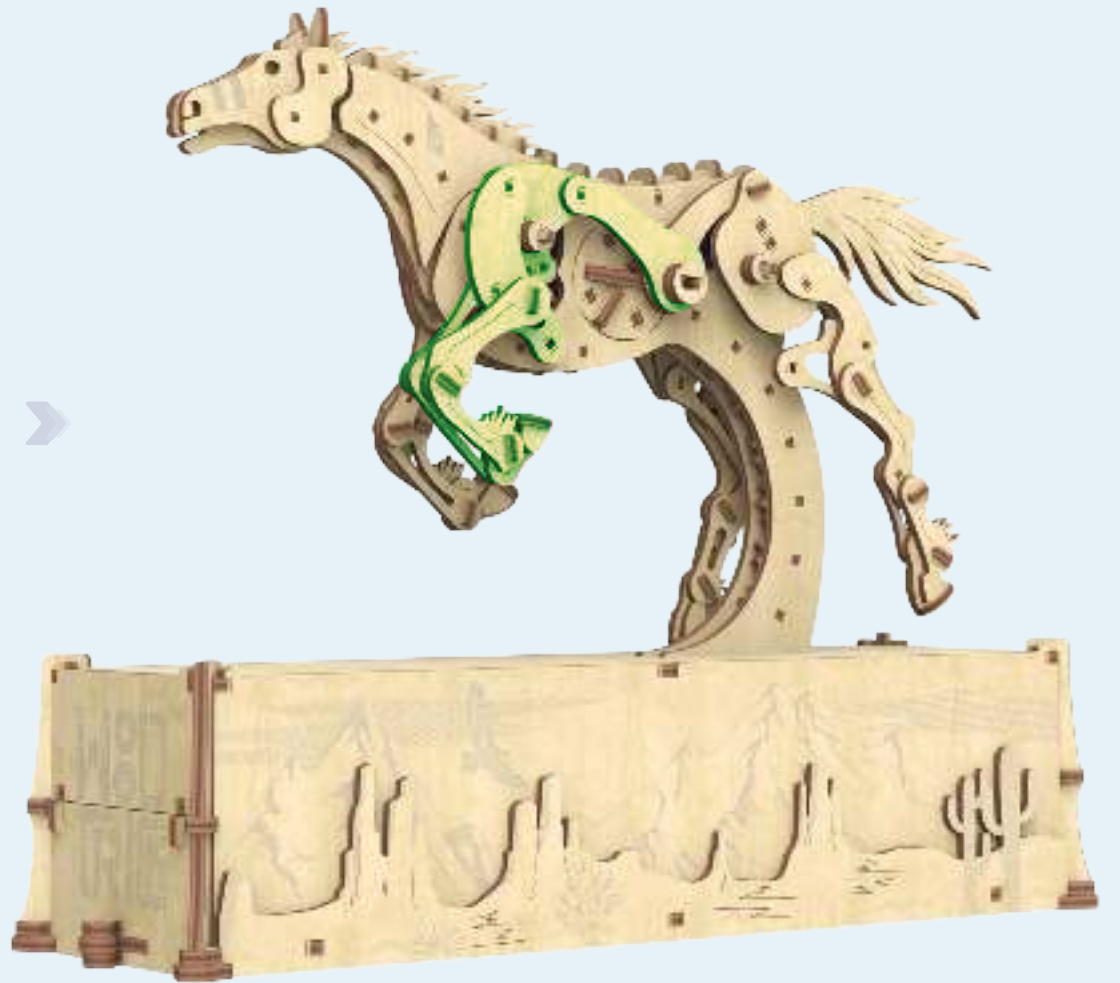
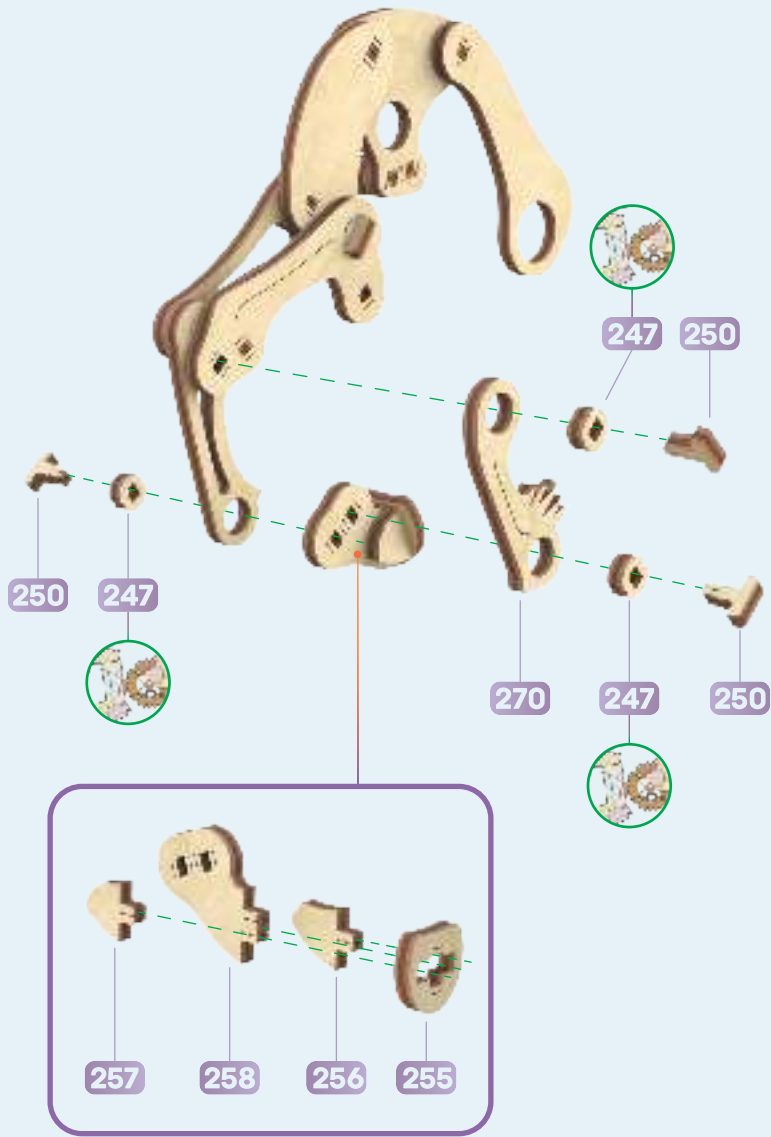



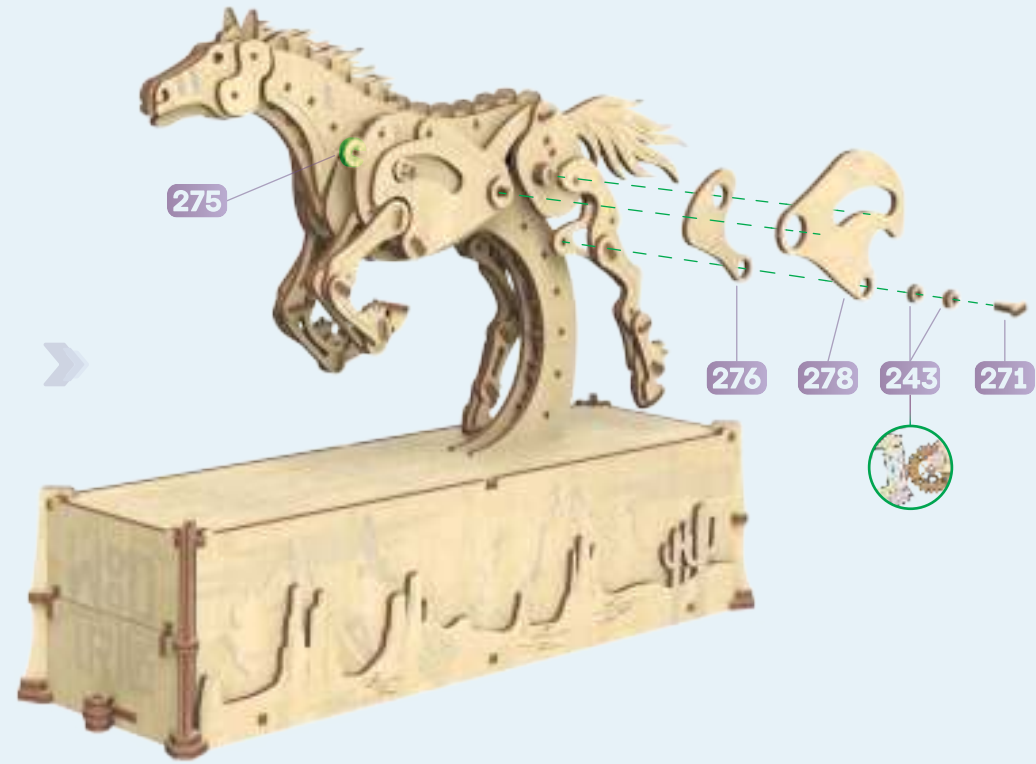
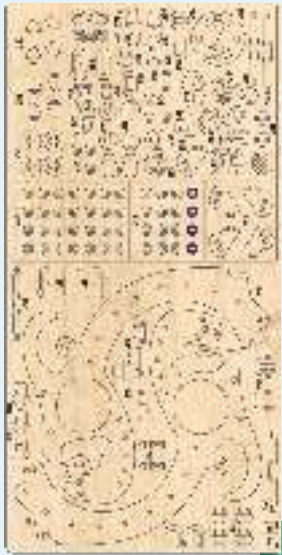
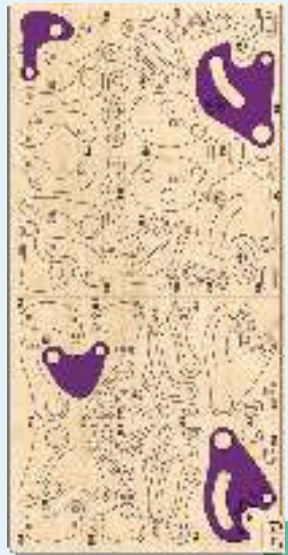
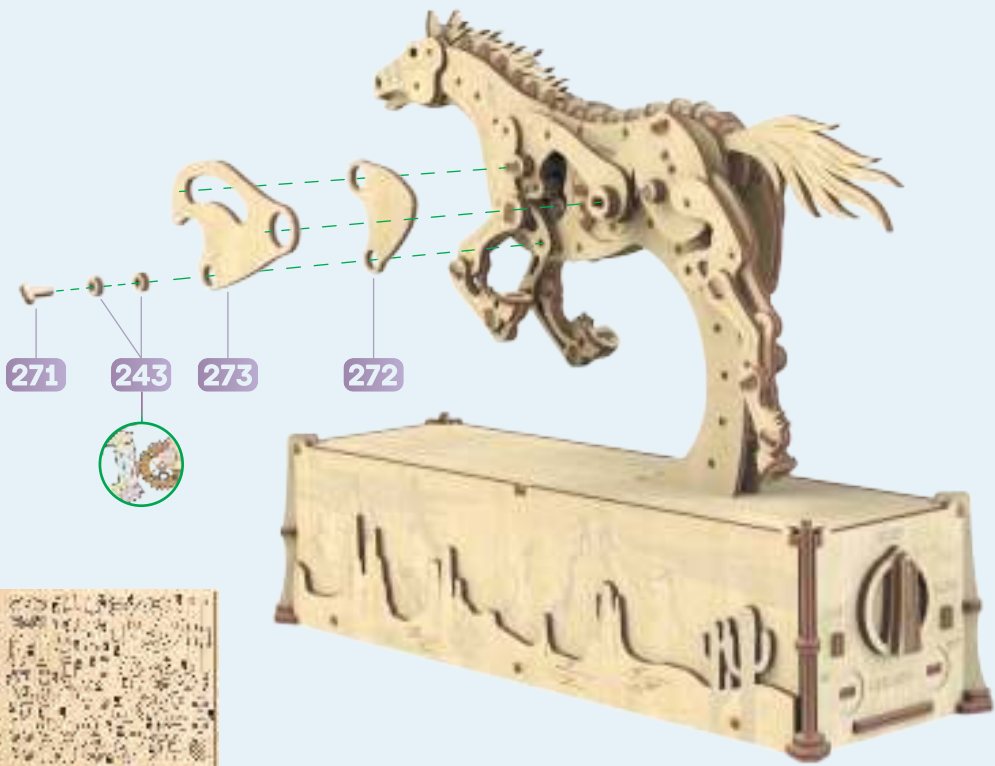

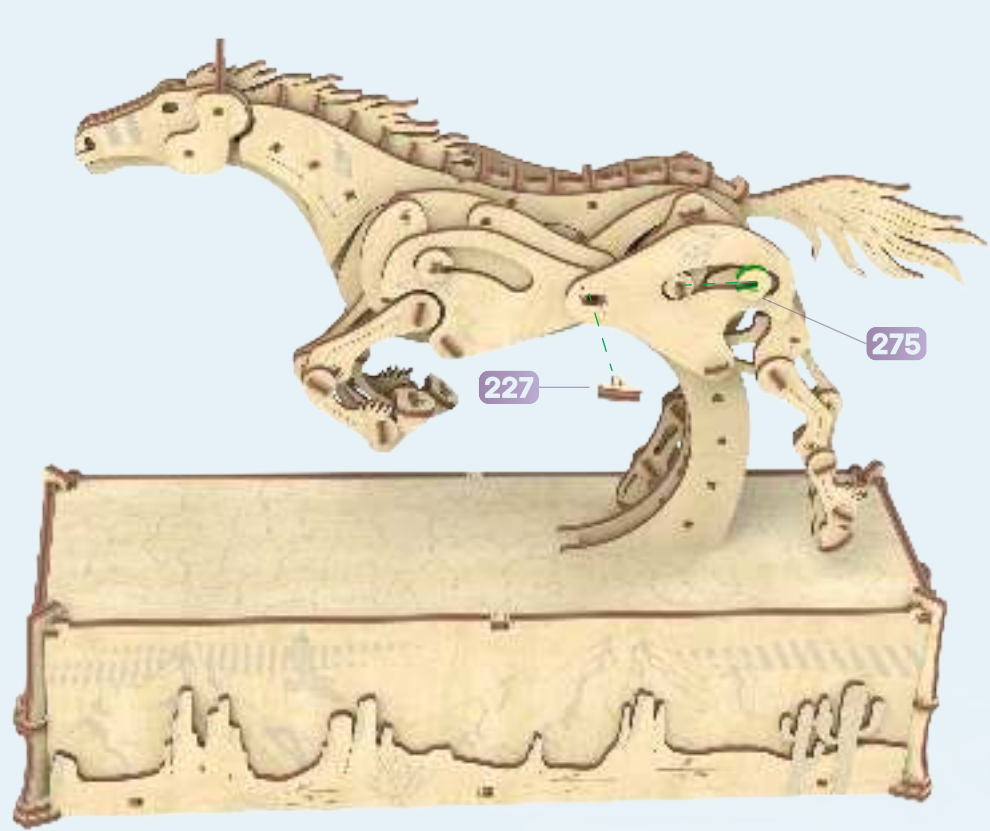

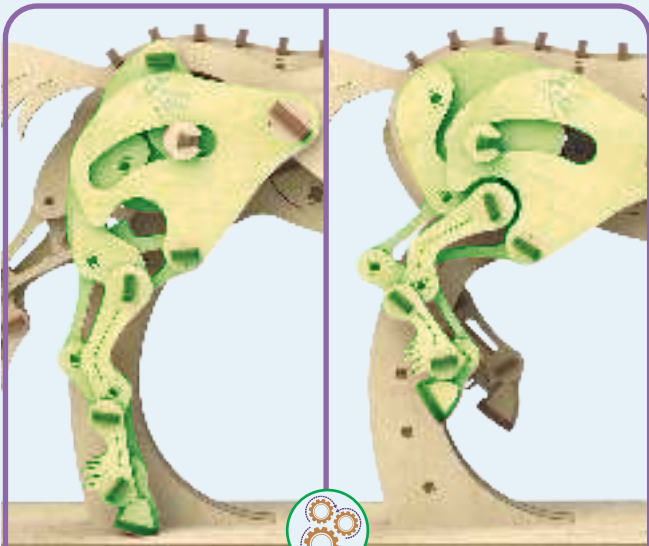

**UA** Перед запуском вручну розробити кожну ногу!

**EN** Run each limb manually before starting!

**DE** Arbeiten Sie vor dem manuellen Start jedes Bein aus!

**FR** Avant la mise en route manuelle faites fonctionner chaque pied!

**IT** Smontare ogni gamba manualmente prima di iniziare!

**ES** Accione manualmente cada extremidad antes de encender el mecanismo.

**PL** Przed uruchomieniem należy ręcznie rozruszać każdą nogę!

**JP** 始める前に、各脚を手動で開発してください!



**UA** У перший запуск увімкнути режим "Slow" на 5-10 хвилин для розробки механізму. На початку ноги можуть заклинювати - у такому разі розворушіть їх вручну до усунення заклинювання.

**EN** When starting it for the first time, turn on the Slow mode for 5-10 minutes to work out the mechanism. Initially, the limbs may be stuck. If so, loosen them manually until they are free of sticking.

**DE** Beim ersten Start schalten Sie den „Slow“-Modus für 5 bis 10 Minuten ein, um den Mechanismus auszuarbeiten. Am Anfang können die Beine verkeilt werden - in diesem Fall rühren Sie sie von Hand, bis Sie die Verklebung beseitigen.

**FR** Lors de la première mise en route, le mode "slow" doit être activé pour 5 ou 10 minutes afin de faire fonctionner le mécanisme. Premièrement, les pieds peuvent se bloquer - dans ce cas, mettez-les en mouvement manuellement jusqu'à l'élimination du blocage.

**IT** Nella prima esecuzione, attivare la modalità "slow" per 5-10 minuti per trattare il meccanismo. All'inizio, le gambe possono incastrarsi - in questo caso, muoverli manualmente fino a quando l'inzeppamento non viene eliminato.

**ES** Al ponerlo en marcha por primera vez, active el modo Slow para unos 5-10 minutos para ajustar el mecanismo. Inicialmente, las extremidades pueden bloquearse. Si es así, aflójelas manualmente hasta que no se atasquen.

**PL** Przy pierwszym uruchomieniu należy włączyć tryb "slow" na 5-10 minut, aby rozruszać mechanizm. Na początku nóżki mogą się zacinać - w takim przypadku należy rozruszać je ręcznie, aż zacięcie zniknie.

**JP** 最初の実行では、メカニズムを開発するために5～10分間「低速」モードをオンにします。最初は脚が引っかかる場合があります。この場合は、詰まりが解消されるまで手動で脚を動かしてください。

**UA** Кнопки (on i off) необхідні для вмикання та вимикання звуку стукоту копит.

**EN** The on and off buttons are required to enable and disable the hoof-tapping sound.

**DE** Die Tasten (On und Off) werden benötigt, um den Hufschlag ein- und auszuschalten.

**FR** Les boutons (on et off) sont nécessaires pour activer et désactiver le son de martèlement des sabots.

**IT** I pulsanti (on e off) sono necessari per accendere e spegnere il suono del battito degli zoccoli.

**ES** Los botones on y off son necesarios para activar y desactivar el sonido de los cascos.

**PL** Przyciski (on i off) są potrzebne do włączania i wyłączenia dźwięku stukania kopyt.

**JP** ひづめの音をオンまたはオフにするには、ボタン(オンとオフ)が必要です



# HOW TO REPLACE A BROKEN PART

Sometimes it happens that a part of the WoodTrick model is lost or damaged.

But you have nothing to worry about because we have the replacement service. This option is free and quick, and you can easily use it for missed or damaged parts of your WoodTrick constructor.

## MAKE THE REPLACEMENT IN 5 SIMPLE STEPS

### STEP 1

Open the Replacement form on our website [woodtrick.com](http://woodtrick.com).

Or you can scan the QR code, which will redirect you to the replacement page.



### STEP 2

Indicate the reason for replacement.

There is no need to attach the photo or video of the broken part, it's enough to choose the reason in the list.

### STEP 3

Mention the name or the set number of the WoodTrick model with the missing part.

Name: MECHANICAL MUSTANG  
Set number: WDTK090

### STEP 4

Choose the board\* which contains the part you need.

*\*All parts and all boards have the numbers. For the replacement you'll need to mention the № of the board. To find the correct board, use the assembly instruction.*

### STEP 5

Fill the delivery address and it's done!

### FREE REPLACEMENT

For each WoodTrick model we provide 2 (two) free replacements. We always send the full board to avoid the risks of damaging a small part during the delivery. For example, if you need part 14 which belongs to Board 1, we will send the whole Board 1.

### NEED SOME HELP?

In case you faced any difficulties with the replacement please contact us: [support@woodtrick.com](mailto:support@woodtrick.com). Our support team is available 24/7 and will assist with the issue. You can also get the consultation from support for any questions about assembly.