

User's Manual

Window Type Manual Model

Before using your product, please read this manual carefully and keep it for future reference.



The design and specifications are subject to change without prior notice for product improvement. Consult with your dealer or manufacturer for details.

AP7010010-00
20141201



CONCEPCION MIDEA INC.



Midea Customer Care
Landline: 863-55-22
Mobile: 0917-863-5522
Toll free: 1-800-10-863-5522

For more information, please visit our website www.midea.com.ph



CONTENTS

1. SAFETY PRECAUTIONS.....	2
2. UNIT PARTS IDENTIFICATION	5
3. AIR CONDITIONER FEATURES	6
4. INSTALLATION	8
5. CARE AND MAINTENANCE	12
6. TROUBLESHOOTING TIPS	13

READ THIS MANUAL



Inside you will find many helpful hints on how to use and maintain your air conditioner properly. Just a little preventive care on your part can save you a great deal of time and money over the life of your air conditioner. You'll find many answers to common problems in the chart of troubleshooting tips. If you review our chart of Troubleshooting Tips first, you may not need to call for service at all.

⚠ CAUTIONS

- This appliance can be used by children aged from 8 years and above and persons with reduced physical, sensory or mental capabilities or lack of experience and knowledge if they have been given supervision and instruction concerning use of the appliance in a safe way and understand the hazards involved. Children shall not play the appliance. Cleaning and maintenance shall not be made by children without supervision.
- If the supply cord is damaged, it must be replaced by the manufacturer, its service agent or similarly qualified persons in order to avoid hazard.
- The appliance shall be installed in accordance with national wiring regulations.
- Do not operate your air conditioner in a wet room such as bathroom or laundry room.
- The appliance with electric heater shall have at least 1 meter space to the combustible materials.
- Contact Midea Customer Care for repair or maintenance of this unit.

















SAFETY PRECAUTIONS

To prevent injury to the user or other people and property damage, the following instructions must be followed. Incorrect operation due to ignoring of instructions may cause harm or damage. The seriousness is classified by the following indications.

 WARNING	This symbol indicates the possibility of death or serious injury.
 CAUTION	This symbol indicates the possibility of injury or damage to property.

	Never do this.
	Always do this.

⚠ WARNING

- | | | |
|---|---|---|
| <p> Plug in power cord properly.</p> <p>• Otherwise, it may cause electric shock or fire due to excess heat generation.</p> | <p> Do not operate or stop the unit by inserting or pulling out the power cord.</p> <p>• It may cause electric shock or fire due to heat generation.</p> | <p> Do not damage or use an unspecified power cord.</p> <p>• It may cause electric shock or fire. • If the power cord is damaged, it may be replaced by the manufacturer or an authorized service center or a similar qualified person in order to avoid a hazard.</p> |
| <p> Do not modify power cord length or share the outlet with other appliances.</p> <p>• It may cause electric shock or fire due to heat generation.</p> | <p> Do not operate with wet hands or in damp environment.</p> <p>• It may cause electric shock.</p> | <p> Do not direct the airflow at room occupants only.</p> <p>• This could damage your health.</p> |
| <p> Always ensure effective earthing.</p> <p>• Incorrect earthing may cause electric shock.</p> | <p> Do not allow water to run into electric parts.</p> <p>• It may cause fire and electric shock.</p> | <p> Always install circuit breaker and a dedicated power circuit.</p> <p>• Incorrect installation may cause fire and electric shock.</p> |
| <p> Unplug the unit if strange sounds, smell, or smoke comes from it.</p> <p>• It may cause fire and electric shock.</p> | <p> Do not use the socket if it is loose or damaged.</p> <p>• It may cause fire and electric shock.</p> | <p> Do not open the unit during operation.</p> <p>• It may cause electric shock.</p> |
| <p> Leave the door closed while the air conditioner is running.</p> <p>• It is not designed to cool the entire house.</p> | <p> Do not use the power cord close to heating appliances.</p> <p>• It may cause fire and electric shock.</p> | <p> Do not use the power cord near flammable gas or combustibles, such as gasoline, benzene, thinner, etc.</p> <p>• It may cause an explosion or fire.</p> |
| <p> Ventilate room before operating air conditioner if there is a gas leakage from another appliance.</p> <p>• It may cause explosion, fire and burns.</p> | <p> Do not disassemble or modify unit.</p> <p>• It may cause failure and electric shock.</p> | |

CAUTION

ⓘ When the air filter is to be removed, do not touch the metal parts of the unit.

- It may cause an injury.

ⓘ Do not clean the air conditioner with water.

- Water may enter the unit and degrade the insulation. It may cause an electric shock.

ⓘ Ventilate the room well when used together with a stove, etc.

- An oxygen shortage may occur.

ⓘ When the unit is to be cleaned, switch off, and turn off the circuit breaker.

- Do not clean unit when power is on as it may cause fire and electric shock, it may cause an injury.

ⓘ Do not put a pet or house plant where it will be expose to direct air flow.

- This could injure the pet or plant.

ⓘ Do not use for special purposes.

- Do not use this air conditioner to preserve precision devices, food, pets, plants, and art objects. It may cause deterioration of quality, etc.

ⓘ Stop operation and close the window in storm or hurricane.

- Operation with windows opened may cause wetting of indoor and soaking of household furniture.

ⓘ Hold the plug by the head of the power plug when taking it out.

- It may cause electric shock and damage.

ⓘ Turn off the main power switch when not using the unit for a long time.

- It may cause failure of product or fire.

ⓘ Do not place obstacles around air-inlets or inside of air-outlet.

- It may cause failure of appliance or accident.

ⓘ Ensure that the installation bracket of the outdoor appliance is not damaged due to prolonged exposure.

- If bracket is damaged, there is concern of damage due to falling of unit.

ⓘ Always insert the filters securely. Clean filter once every two weeks.

- Operation without filters may cause failure.

ⓘ Do not use strong detergent such as wax or thinner but use a soft cloth.

- Appearance may be deteriorated due to change of product color or scratching of its surface.

ⓘ Do not place heavy object on the power cord and ensure that the cord is not compressed.

- There is danger of fire or electric shock.

ⓘ Do not drink water drained from air conditioner.

- It contains contaminants and could make you sick.

ⓘ Use caution when unpacking and installing. Sharp edges could cause injury.

ⓘ If water enters the unit, turn the unit off at the power outlet and switch off the circuit breaker. Isolate supply by taking the power-plug out and contact a qualified service technician.

SAFETY PRECAUTIONS (prior to operation)

Preparing for operation

1. Contact an installation specialist for installation.
2. Plug in the power plug properly.
3. Do not use a damaged or non-standard power cord.
4. Do not share the same outlet with other appliances.
5. Do not use an extension cord.
6. Do not start/stop operation by plugging/unplugging the power cord.

Usage

1. Exposure to direct airflow for an extended period of time could be hazardous to your health. Do not expose occupants, pets, or plants to direct airflow for extended periods of time.
2. Due to possibility of oxygen deficiency, ventilate the room when used together with stoves or other heating devices.
3. Do not use this air conditioner for non-specified special purposes (e.g. preserving precision devices, food, pets, plants, and art objects). Usage in such a manner could harm such property.

Cleaning and Maintenance

1. Do not touch the metal parts of the unit when removing the filter. Injuries can occur when handling sharp metal edges.
2. Do not use water to clean inside the air conditioner. Exposure to water can destroy the insulation, leading to possible electric shock.
3. When cleaning the unit, first make sure that the power and circuit breaker are turned off.

Service

For repair and maintenance, contact your authorised service dealer.

Operating Temperature

Cooling operation	Outdoor temp:	18-43°C
	Indoor temp:	17-32 °C

Note: Performance may be reduced outside of these operating temperatures.

UNIT PARTS IDENTIFICATION

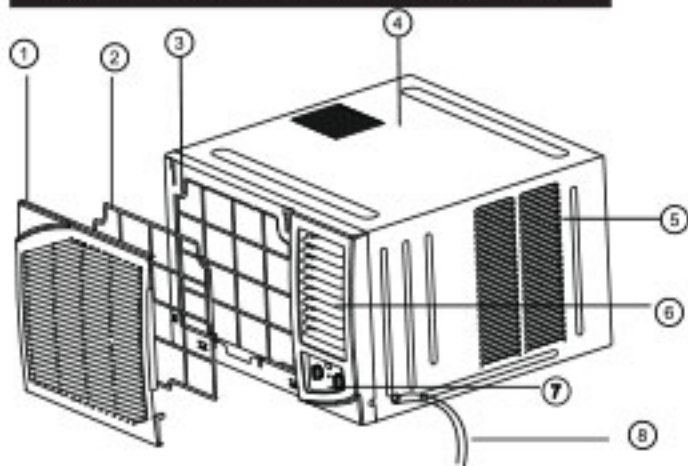

1. Front panel
2. Air filter
3. Frame
4. Cabinet
5. Air inlet grille (outdoor side)
6. Air outlet grille
7. Operation knob
8. Power supply cord

1. Power cord conductors are distinguished according to color as follows (see Fig.1)
2. For your safety and protection, this unit is earthed through the power cord (see Fig.2)
Please contact the manufacturer or its service agent or a similar qualified person if you want to replace it.
3. Besure that the unit being correctly grounded. The wall outlet (Air-break switch) should be provided with reliable earth wire.
4. The unit should be provided with an individual circuit and the circuit breaker/fuse rating should be the same as that of the power cord and wall outlet.

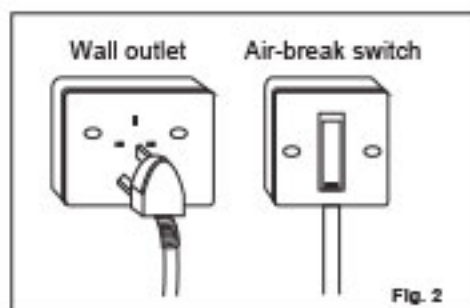
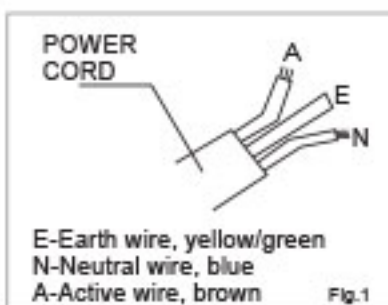

Accessories

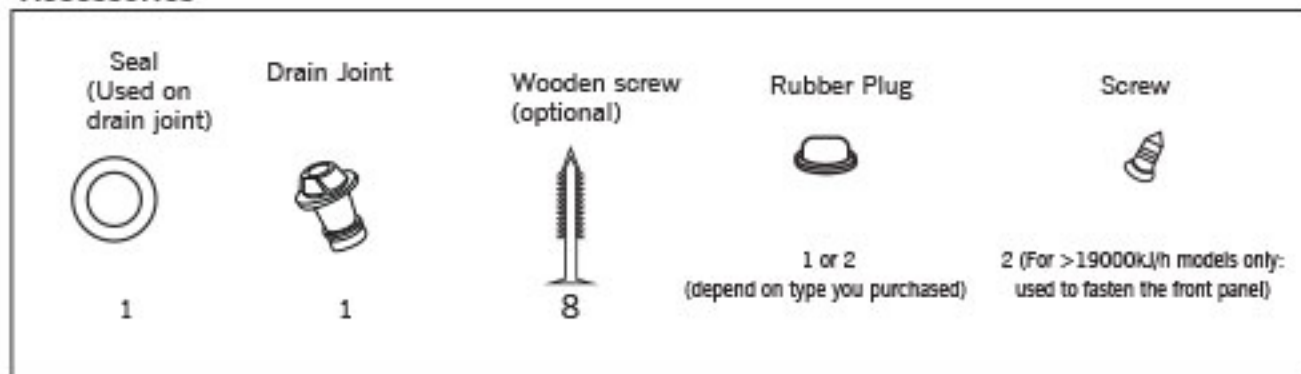

AIR CONDITIONER FEATURES

Control Panel

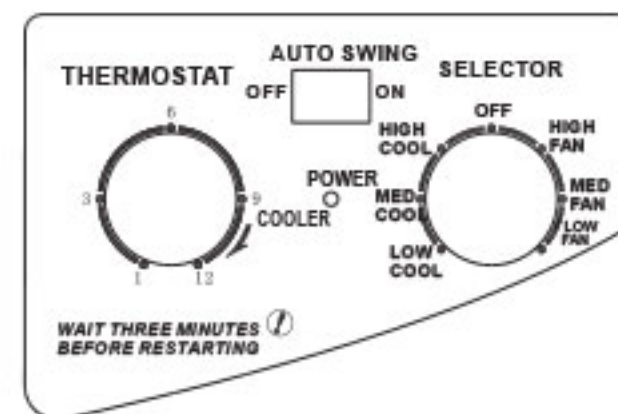

SELECTOR

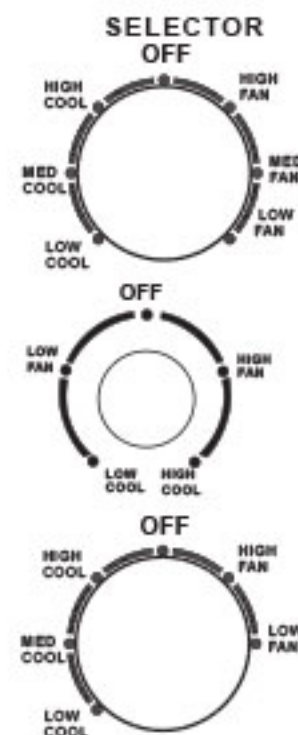

Cool Mode

The desired cool setting is selected by rotating the knob to the right to the appropriate location.

“HIGH COOL” has maximum cooling effect and airflow
“MED COOL” has the intermediate cooling effect and airflow

“LOW COOL” has minimum cooling effect and airflow
“OFF” will completely shut off the unit.

NOTE All the illustrations in the manual are for explanation purpose only. Your air conditioner may be slightly different. The actual shape shall prevail.

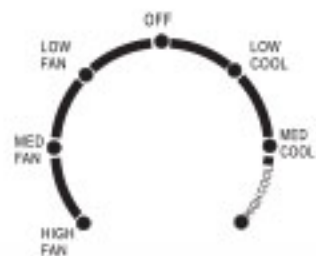

Fan Mode

Rotate the knob to the left to select your choice of fan speeds for air circulation.

Note: When selecting a fan speed, the compressor will not run.

Note

When turning the SELECTOR knob from "LOW COOL" to "HIGH COOL", keep your speed slow as far as possible. Do not change the operation mode between "LOW COOL" and "HIGH COOL" too often.

THERMOSTAT

THERMOSTAT

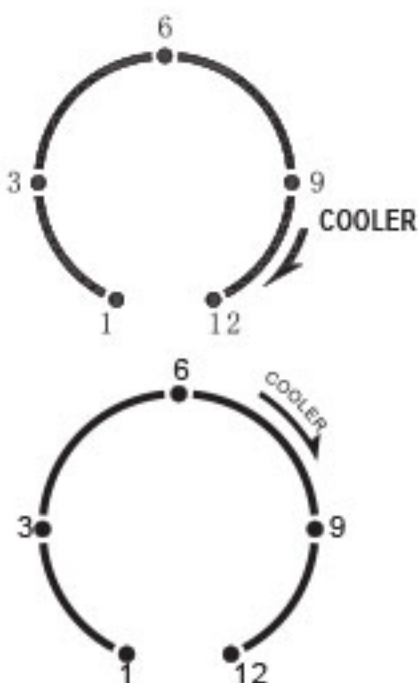

Thermostat

The thermostat is used to set the desired room temperature when the unit is being operated in the COOL MODE.

To set the desired room temperature, rotate the thermostat switch to the desired setting. After the set temperature is achieved the thermostat will automatically start and stop the compressor in order to maintain the desired set temperature.

Rotate the thermostat selector clockwise for higher cool settings. Higher cool settings will provide lower room temperature. Rotate the thermostat selector counter clockwise for lower cool settings. Lower cool settings will provide higher room temperature.

NOTE: During the cooling operation of the unit, when the thermostat knob is rotated clockwise, allow at least three minutes before turning back the knob to the "COOLER" direction. Otherwise the fuse may blow due to an overload of the unit.

AUTO SWING

Horizontal air flow adjustment (automatically)

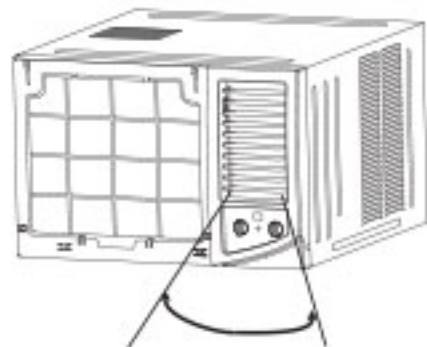

When the AUTO SWING switch is turned to "ON" position, the vertical louvers automatically oscillate right and left sweeping the cold air alternately to obtain comfortable cooling. The vertical louvers may be stopped at any position when the AUTO SWING switch is turned "OFF".

Vertical air flow adjustment (manually)



To adjust vertical air flow direction, adjust any one of the horizontal louver blades. When turning up or down the horizontal louver blades, always keep horizontal the top or bottom blades. This can effectively prevent water drops condensed on the front panel of the unit.

Vent Control

The vent control is located above the control knobs. The operation method is different on different models (see the following figures).

For maximum cooling efficiency, CLOSE the vent. This will allow internal air circulation. OPEN the vent to discharge stale air.



To open the vent, pull the lever toward you
To close it, push it in.



To open the vent, set the lever to the right position
To close it, set the lever in the left position.

NOTE: The VENTILATION LEVER should normally be kept in the CLOSED position during cooling for maximum cooling effect. The "OPEN" position is used only for ventilation.

INSTALLATION INSTRUCTIONS

SELECT THE BEST LOCATION

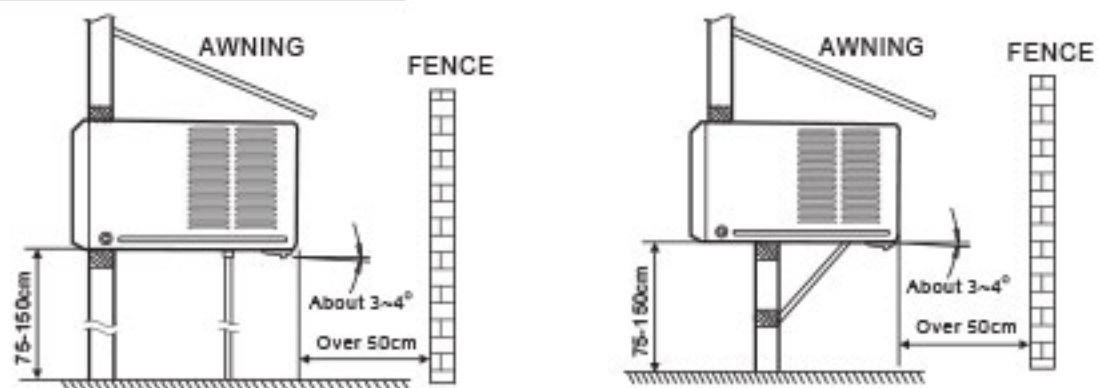

1. To avoid vibration and noise, make sure the units is installed securely and firmly.
2. Install the unit where the sunlight does not shine directly on the unit.
If the unit receives direct sunlight, build an awning to shade the cabinet.
3. There should be no obstacle, such as a fence or wall within 50 cm from the back of the cabinet because it will prevent heat radiation on the condenser. Restriction of outside air will greatly reduce the cooling efficiency of the air conditioner.
4. Install the unit a little obliquely outward not to leak the condensed water into the room (about 3~4° with level).
5. Install the unit with its bottom portion 75~150 cm above the floor level.
6. The power cord must be connected to an independent circuit. The yellow/green wire must be grounded.

CAUTION

All side louvers of the cabinet must remain exposed to the outside of the structure.

Installation of the Housing

Step 1

Remove the air conditioner from its packaging, remove fixing screws and slide the air conditioner out of from housing. (Refer to Installation Steps).

Step 2

Prepare the hole in the wall so that the bottom of the housing is well supported, the top has minimum clearance and the air inlet louvers have clearance as shown below in options A and B. Holes from the outside through to the cavity should be sealed. The housing should slope down towards the rear by about 5mm to allow water formed during operation to drain.

Step 3

Install the housing into the wall and ensure the foam seals are not damaged. Seal or fill the gaps around the inside and outside to provide satisfactory appearance and protection against the weather, insects and rodents.

Note: Unit may be supported by a solid frame from below or by a hanger from a solid overhead support.

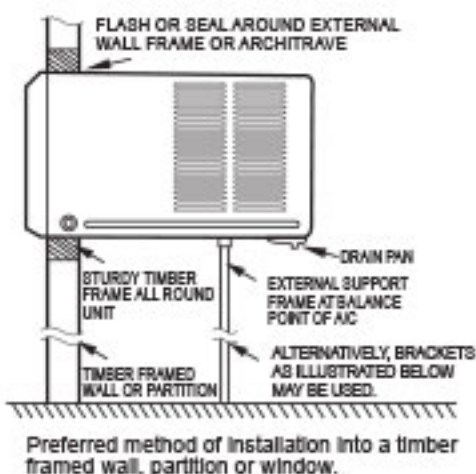

Installations of the unit into the housing

1. Slide the unit into the housing until is firmly against the rear of the housing. Care is required to ensure the foam sealing strips on the housing remain in position.
2. Connect the air conditioner to the power and position the excess cord length beneath the air conditioner base.
3. Engage the chassis fixing brackets into the bottom housing rail and secure to the base with the screw provided.
4. Remove the front panel from it's carton and plastic bag and fit as per the Installation Instruction.
5. Switch unit on. Check for operation of the unit and check for vibration in the installation.
6. Fit the drain pan to the housing and run a drain line to a suitable location if required.

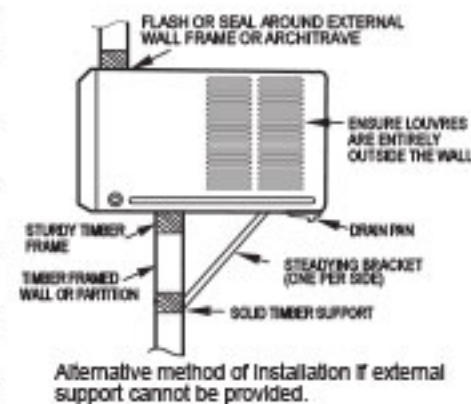

Installations of the unit into the wall

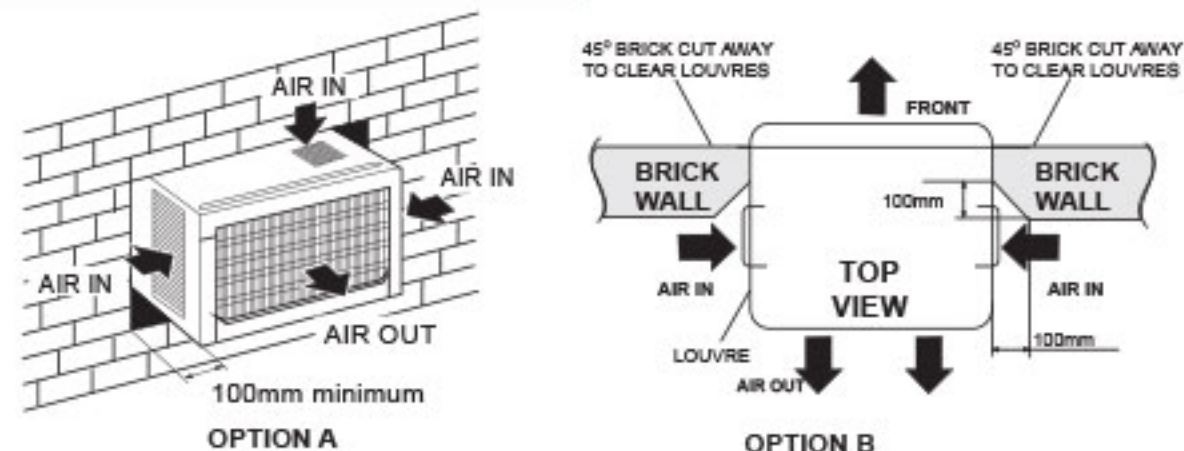

Installations steps

Step 1. Remove the front panel and the air filter

1. Hold the slot under the front panel, then uplift it outwards, and remove the front panel (See Fig.1).
2. Pinch the handle under the air filter and make the air filter arched, remove it from the slot from underside to upside (See Fig.2).

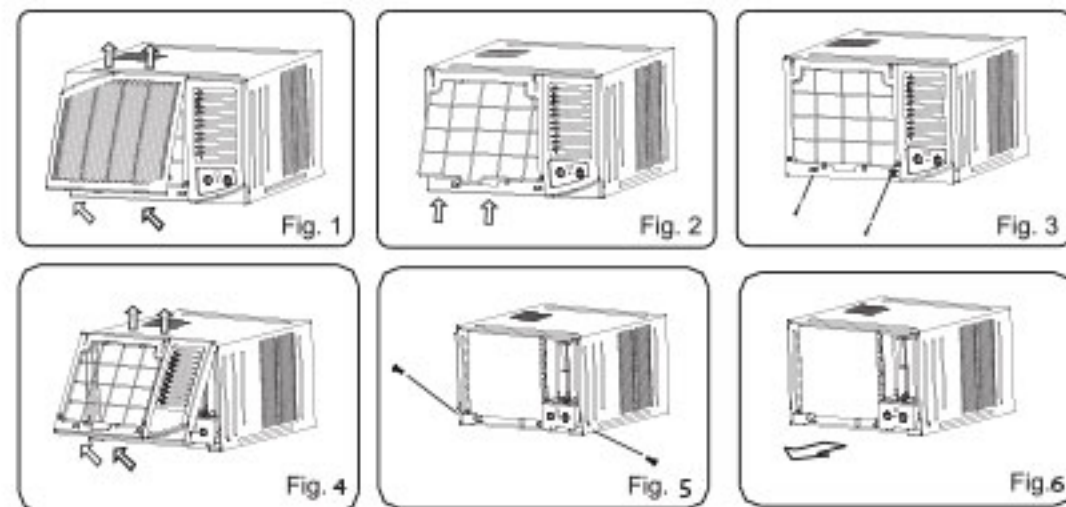

Step 2. Remove the frame

1. Remove the two fixing screws from the frame (See Fig.3).
2. Grasp the left corner of the frame's underside, then loosen the frame (See Fig.4).

Step 3. Installation.

1. Remove the two fixing screws on the chassis fixing brackets, then remove the chassis fixing brackets (See Fig.5).
2. Grasp the handle on the chassis and carefully slide the air conditioner out of the cabinet (See Fig.6).
3. When need to drain water, install the drain plug on the Chassis board. Then fix the cabinet on the bracket (provide for yourself) (See Fig.7).
4. Push the unit chassis into the cabinet (See Fig.8).
5. Fix the chassis and cabinet (See Fig.5).

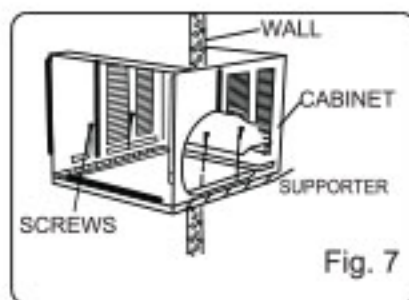

Fig. 7

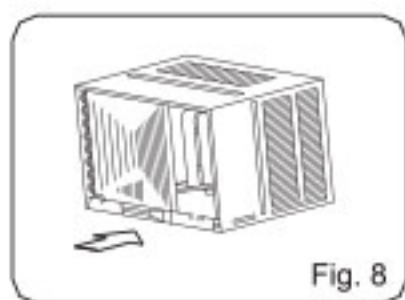

Fig. 8

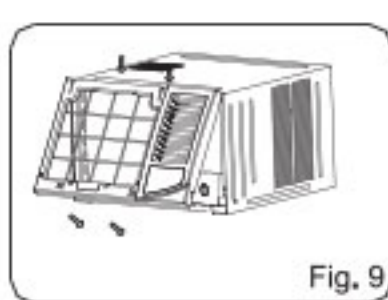

Fig. 9

Step 4. Install the frame.

Fix the screws on the frame (See Fig.3).

Step 5. Install the air filter and front panel.

1. Install the air filter into the frame's slot from upside to underside (See Fig.2).
2. Hang the front panel on the frame's buckle, then press the front panel into the frame's slot until you hear a click (See Fig.10).

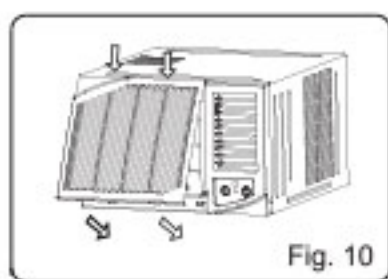

Fig. 10

Drainage

To meet different requirement of different type of air conditioner, there are different kinds of methods for your choice to treat the condensed water.

You can choose back drainage or non-drainage. See the following procedures to perform back drainage:

1. Fit the seal onto the drain joint (which provided with your air conditioner accessory).
2. Remove the rubber plug from the back of the unit (if applicable), and insert the rubber plug into the bottom drain hole of the unit.
3. Attach the drain joint to the back of the cabinet where you remove the plug and rotate 90° to securely assemble them.
4. Connect the drain joint with an extension drain hose (locally purchased).

Note: If you choose non-drainage, both the bottom and the back drain holes of the unit should be inserted with rubber plugs. When you choose non-drainage the air conditioner will be perfect cooling efficiency.

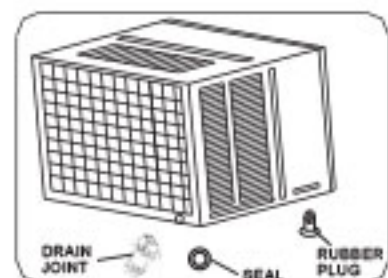

CARE AND CLEANING

CAUTION

Clean your air conditioner occasionally to keep it looking new. **Be sure to unplug the unit before cleaning to prevent shock or fire hazards.**

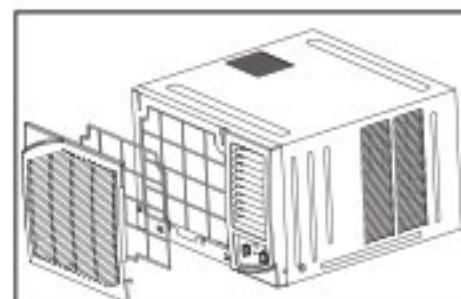

Air Filter Cleaning

The air filter should be checked at least once a month to see if cleaning is necessary. Trapped particles in the filter can build up and cause an accumulation of frost on the cooling coils.

- Hold the slot under the front panel, then uplift it onwards, and remove the front panel.
- Pinch the handle under the air filter and make the air filter arched, remove it from the underside to upside.
- Wash the filter using liquid dishwashing detergent and warm water. rinse filter thoroughly.
- Gently shake excess water from the filter. Be sure the filter thoroughly dry before replacing.
- Or, instead of washing you may vacuum the filter to clean.

Note: Never use hot water over 40°C (104°F) to clean the air filter. Never attempt to operate the unit without the air filter.

Cabinet Cleaning

- Be sure to unplug the air conditioner to prevent shock or fire hazard. The cabinet and front may be dusted with an oil-free cloth or washed with a cloth dampened in a solution of warm water and mild liquid dishwashing detergent. Rinse thoroughly and wipe to dry.
- Never use harsh cleaners, wax or polish on the cabinet front.
- Be sure to wring excess water from the cloth before wiping around the controls.
- Excess water in or around the controls may cause damage to the air conditioner.
- Plug in air conditioner.

Note: Never use water over 50°C, alcohol, gasoline, acid, solvent or brush to clean the front panel as this will damage the surface of the part.

TROUBLESHOOTING TIPS

Before calling for service, review this list. It may save you time and expense. This list includes common occurrences that are not the result of defective workmanship or material in this appliance.

Problem	Solution
Air conditioner does not start	Wall plug disconnected. Push plug firmly into wall outlet.
	House fuse blown or circuit breaker tripped. Replace fuse with time delay type or reset circuit breaker.
	Selector Control in OFF position. Turn selector to the desired FAN or COOL setting.
	Unit turned off by moving thermostat to a higher number and then immediately turning back to a colder number. Wait approximately 3 minutes. Listen for compressor to start.
	Unit turned off and then on too quickly. Turn unit off and wait 3 minutes before restarting.
	Thermostat set too low. Adjust thermostat to higher number for cooling.
Air from unit does not feel cold enough	Turn selector to a higher COOL position.
	Thermostat set too warm. Set thermostat to colder temperature.
	Room temperature below 18°C(64°F). Cooling may not occur until room temperature rises above 18°C(64°F).
	Temperature sensing tube touching cold coil, located behind air filter. Straighten tube away from coil.
Air conditioner cooling, but room is too warm- ice forming on cooling coil behind decorative front.	Outdoor temperature below 18°C(64°F). To defrost the coil, set selector to FAN position. Then, set thermostat to warmer position.
	Air filter may be dirty. Clean filter. Refer to Care and Cleaning section. To defrost, set selector to FAN.
	Thermostat set too cold for night-time cooling. To defrost the coil, set selector to a FAN position. Then, set thermostat to a warmer position.

Problem	Solution
Air conditioner cooling, but room is too warm- NO ice forming on cooling coil behind decorative front.	Dirty air filter- air restricted. Clean air filter. Refer to Care and Cleaning section.
	Thermostat set too warm. Turn thermostat clockwise to a colder setting.
	Air directional louvers positioned improperly. Position louvers for better air distribution.
	Front of units is blocked by drapes, blinds, furniture, etc. - restricts air distribution. Clear blockage in front of unit.
	Doors, windows, registers, etc. Open- cold air escapes. Close doors, windows, registers.
	Unit recently turned on in hot room. Allow additional time to remove "Stored heat" from walls, ceiling, floor and furniture.
Air conditioner turns on and off rapidly	Dirty air filter- air restricted. Clean air filter.
	Outside temperature extremely hot. Set to high cool to bring air past cooling coils more frequently.
Noise when unit is cooling	Air movement sound. This is normal . If too loud, turn selector to lower FAN setting.
	Sound of fan hitting water-moisture removal system. This is normal when humidity is high. Close doors, windows and registers.
	Window vibration - poor installation. Refer to installation instructions or check with installer.
Water dripping INSIDE when unit is cooling.	Improper installation. Tilt air conditioner slightly to the outside to allow water drainage. Refer to installation instructions - check with installer.
	Unit removing large quantity of moisture from humid room. This is normal during excessively humid days.
Water dripping OUTSIDE when unit is cooling.	
If the trouble has not been corrected, please contact Concepcion Midea Customer Care representative. Be sure to inform them of the detailed malfunctions and unit model number.	
Notes: Do not attempt to repair the unit yourself. Always consult an authorized service provider.	