



The design and specifications are subject to change without prior notice for product improvement. Consult with your dealer or manufacturer for details.

A quality product of



CONCEPCION MIDEA INC.



For more information, please visit our website www.midea.com.ph

User's Manual

Window Type Inverter Model

Before using your product, please read this manual carefully and keep it for future reference.



CONTENTS

1. SAFETY PRECAUTIONS.....	2
2. UNIT PARTS IDENTIFICATION	5
3. AIR CONDITIONER FEATURES	6
4. HANDLING THE REMOTE CONTROLLER.....	8
5. INSTALLATION INSTRUCTIONS.....	14
6. CARE AND CLEANING.....	17
7. TROUBLESHOOTING TIPS.....	18

READ THIS MANUAL

Inside you will find many helpful hints on how to use and maintain your air conditioner properly. Just a little preventive care on your part can save you a great deal of time and money over the life of your air conditioner. You'll find many answers to common problems in the chart of troubleshooting tips. If you review our chart of Troubleshooting Tips first, you may not need to call for service at all.

CAUTIONS

- This appliance can be used by children aged from 8 years and above and persons with reduced physical, sensory or mental capabilities or lack of experience and knowledge if they have been given supervision and instruction concerning use of the appliance in a safe way and understand the hazards involved. Children shall not play with the appliance. Cleaning and maintenance shall not be done by children without supervision.
- If the supply cord is damaged, it must be replaced by the manufacturer, its service agent or similarly qualified persons in order to avoid hazard.
- The appliance shall be installed in accordance with national wiring regulations.
- Do not operate your air conditioner in a wet room such the bathroom or the laundry room.
- Contact Midea Customer Care for repair or maintenance of this unit.

WARNING (be applicable for R32 refrigerant)

- Do not use means to accelerate the defrosting process or to clean, other than those recommended by manufacturer.
- The appliance shall be stored in a room without continuously operating ignition sources (for example: open flames, an operating gas appliance or an operating electric heater).
- Do not pierce or burn.
- Be aware that the refrigerants may not contain the odour.
- Appliance should be installed, operated and stored in a room with a floor area larger than 4m².
- Compliance with national gas regulations shall be observed.
- Keep ventilation openings clear of obstruction.
- The appliance shall be stored so as to prevent mechanical damage from occurring.
- A warning that the appliance should be stored in a well ventilated area where the room size corresponds to the room area as specified for operation.
- Any person who is involved with working on or breaking into the refrigerant circuit should hold a current valid certificate from an industry-accredited assessment authority, which authorises their competence to handle refrigerants safely in accordance with an industry recognised assessment specification.
- Servicing shall only be performed as recommended by the equipment manufacturer. Maintenance and repair requiring the assistance of other skilled personnel shall be carried out under the supervision of person competent in the use of flammable refrigerants.

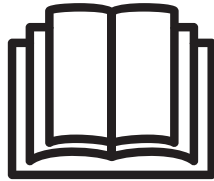





OTHER TIPS (be applicable for R32 refrigerant)

1. Transport of equipment containing flammable refrigerants
See transport regulations
2. Marking of equipment using signs
See local regulations
3. Disposal of equipment using flammable refrigerants
See national regulations.
4. Storage of equipment/appliances
The storage of equipment should be in accordance with the manufacturer's instructions.
5. Storage of packed (unsold) equipment
Storage package protection should be constructed such that mechanical damage to the equipment inside the package will not cause a leak of the refrigerant charge.
The maximum number of pieces of equipment permitted to be stored together will be determined by local regulations.
6. Information on servicing
 - 1) Checks to the area
Prior to beginning work on systems containing flammable refrigerants, safety checks are necessary to ensure that the risk of ignition is minimised. For repair to the refrigerating system, the following precautions shall be complied with prior to conducting work on the system.
 - 2) Work procedure
Work shall be undertaken under a controlled procedure so as to minimise the risk of a flammable gas or vapour being present while the work is being performed.
 - 3) General work area
All maintenance staff and others working in the local area shall be instructed on the nature of work being carried out. Work in confined spaces shall be avoided. The area around the workspace shall be sectioned off. Ensure that the conditions within the area have been made safe by control of flammable material.
 - 4) Checking for presence of refrigerant
The area shall be checked with an appropriate refrigerant detector prior to and during work, to ensure the technician is aware of potentially flammable atmospheres. Ensure that the leak detection equipment being used is suitable for use with flammable refrigerants, i.e. non-sparking adequately sealed or intrinsically safe.
 - 5) Presence of fire extinguisher
If any hot work is to be conducted on the refrigeration equipment or any associated parts, appropriate fire extinguishing equipment shall be available to hand. Have a dry powder or CO₂ fire extinguisher adjacent to the charging area.
 - 6) No ignition sources
No person carrying out work in relation to a refrigeration system which involves exposing any pipe work that contains or has contained flammable refrigerant shall use any sources of ignition in such a manner that it may lead to the risk of fire or explosion. All possible ignition sources, including cigarette smoking, should be kept sufficiently far away from the site of installation, repairing, removing and disposal, during which flammable refrigerant can possibly be released to the surrounding space. Prior to work taking place, the area around the equipment is to be surveyed to make sure that there are no flammable hazards or ignition risks. "No Smoking" signs shall be displayed.

















SAFETY PRECAUTIONS

To prevent injury to the user or other people and property damage, the following instructions must be followed. Incorrect operation due to ignoring of instructions may cause harm or damage. The seriousness is classified by the following indications.

 WARNING	This symbol indicates the possibility of death or serious injury.
 CAUTION	This symbol indicates the possibility of injury or damage to property.

	Never do this.
	Always do this.

WARNING

- | | | |
|--|--|--|
| <p> Plug in power cord properly.</p> <ul style="list-style-type: none"> ● Otherwise, it may cause electric shock or fire due to excess heat generation. | <p> Do not operate or stop the unit by inserting or pulling out the power cord.</p> <ul style="list-style-type: none"> ● It may cause electric shock or fire due to heat generation. | <p> Do not damage or use an unspecified power cord.</p> <ul style="list-style-type: none"> ● It may cause electric shock or fire. If the power cord is damaged, it may be replaced by the manufacturer or an authorized service center or a similar qualified person in order to avoid a hazard. |
| <p> Do not modify power cord length or share the outlet with other appliances.</p> <ul style="list-style-type: none"> ● It may cause electric shock or fire due to heat generation. | <p> Do not operate with wet hands or in damp environment.</p> <ul style="list-style-type: none"> ● It may cause electric shock. | <p> Do not direct the airflow at room occupants only.</p> <ul style="list-style-type: none"> ● This could damage your health. |
| <p> Always ensure effective earthing.</p> <ul style="list-style-type: none"> ● Incorrect earthing may cause electric shock. | <p> Do not allow water to run into electric parts.</p> <ul style="list-style-type: none"> ● It may cause fire and electric shock. | <p> Always install circuit breaker and a dedicated power circuit.</p> <ul style="list-style-type: none"> ● Incorrect installation may cause fire and electric shock. |
| <p> Unplug the unit if strange sounds, smell, or smoke comes from it.</p> <ul style="list-style-type: none"> ● It may cause fire and electric shock. | <p> Do not use the socket if it is loose or damaged.</p> <ul style="list-style-type: none"> ● It may cause fire and electric shock. | <p> Do not open the unit during operation.</p> <ul style="list-style-type: none"> ● It may cause electric shock. |
| <p> Leave the door closed while the air conditioner is running.</p> <ul style="list-style-type: none"> ● It is not designed to cool the entire house. | <p> Do not use the power cord close to heating appliances.</p> <ul style="list-style-type: none"> ● It may cause fire and electric shock. | <p> Do not use the power cord near flammable gas or combustibles, such as gasoline, benzene, thinner, etc.</p> <ul style="list-style-type: none"> ● It may cause an explosion or fire. |
| <p> Ventilate room before operating air conditioner if there is a gas leakage from another appliance.</p> <ul style="list-style-type: none"> ● It may cause explosion, fire and burns. | <p> Do not disassemble or modify unit.</p> <ul style="list-style-type: none"> ● It may cause failure and electric shock. | |

1

CAUTION

- | | | |
|--|--|---|
| <p> When the air filter is to be removed, do not touch the metal parts of the unit.</p> <ul style="list-style-type: none"> ● It may cause an injury. | <p> Do not clean the air conditioner with water.</p> <ul style="list-style-type: none"> ● Water may enter the unit and degrade the insulation. It may cause an electric shock. | <p> Ventilate the room well when used together with a stove, etc.</p> <ul style="list-style-type: none"> ● An oxygen shortage may occur. |
| <p> When the unit is to be cleaned, switch off and turn off the circuit breaker.</p> <ul style="list-style-type: none"> ● Do not clean unit when power is on as it may cause fire and electric shock. It may also cause an injury. | <p> Do not put a pet or house plant where it will be exposed to direct air flow.</p> <ul style="list-style-type: none"> ● This could injure the pet or plant. | <p> Do not use for special purposes.</p> <ul style="list-style-type: none"> ● Do not use this air conditioner to preserve precision devices, food, pets, plants, and art objects. It may cause deterioration of quality, etc. |
| <p> Stop operation and close the window in a storm or hurricane.</p> <ul style="list-style-type: none"> ● Operation with windows opened may cause wetting of indoor and soaking of household furniture. | <p> Hold the plug by the head of the power plug when taking it out.</p> <ul style="list-style-type: none"> ● It may cause electric shock and damage. | <p> Turn off the main power switch when not using the unit for a long time.</p> <ul style="list-style-type: none"> ● It may cause failure of product or fire. |
| <p> Do not place obstacles around air-inlets or inside of air-outlet.</p> <ul style="list-style-type: none"> ● It may cause failure of appliance or accident. | <p> Ensure that the installation bracket of the outdoor appliance is not damaged due to prolonged exposure.</p> <ul style="list-style-type: none"> ● If bracket is damaged, unit may fall and get damaged. | <p> Always insert the filters securely. Clean filter once every two weeks.</p> <ul style="list-style-type: none"> ● Operation without filters may cause failure. |
| <p> Do not use strong detergent such as wax or thinner but use a soft cloth.</p> <ul style="list-style-type: none"> ● Appearance may be deteriorated due to change of product color or scratching of its surface. | <p> Do not place heavy objects on the power cord and ensure that the cord is not compressed.</p> <ul style="list-style-type: none"> ● There is danger of fire or electric shock. | <p> Do not drink water drained from air conditioner.</p> <ul style="list-style-type: none"> ● It contains contaminants and could make you sick. |
| <p> Use caution when unpacking and installing. Sharp edges could cause injury.</p> | | <p> If water enters the unit, turn the unit off at the power outlet and switch off the circuit breaker. Isolate supply by taking the power-plug out and contact a qualified service technician.</p> |

2

Safety Precautions (prior to operation)

Preparing for operation

1. Contact an installation specialist for installation.
2. Plug in the power plug properly.
3. Do not use a damaged or non-standard power cord.
4. Do not share the same outlet with other appliances.
5. Do not use an extension cord.
6. Do not start/stop operation by plugging/unplugging the power cord.

Usage

1. Exposure to direct airflow for an extended period of time could be hazardous to your health. Do not expose occupants, pets, or plants to direct airflow for extended periods of time.
2. Due to possibility of oxygen deficiency, ventilate the room when used together with stoves or other heating devices.
3. Do not use this air conditioner for non-specified special purposes (e.g. preserving precision devices, food, pets, plants, and art objects). Usage in such a manner could harm such property.

Cleaning and Maintenance

1. Do not touch the metal parts of the unit when removing the filter. Injuries can occur when handling sharp metal edges.
2. Do not use water to clean inside the air conditioner. Exposure to water can destroy the insulation, leading to possible electric shock.
3. When cleaning the unit, first make sure that the power and circuit breaker are turned off.

Service

For repair and maintenance, contact your authorised service dealer.

Operating Temperature

Cooling operation	Outdoor temp:	18-43°C
	Indoor temp:	17-32°C

Note: Performance may be reduced outside of these operating temperatures.

UNIT PARTS IDENTIFICATION

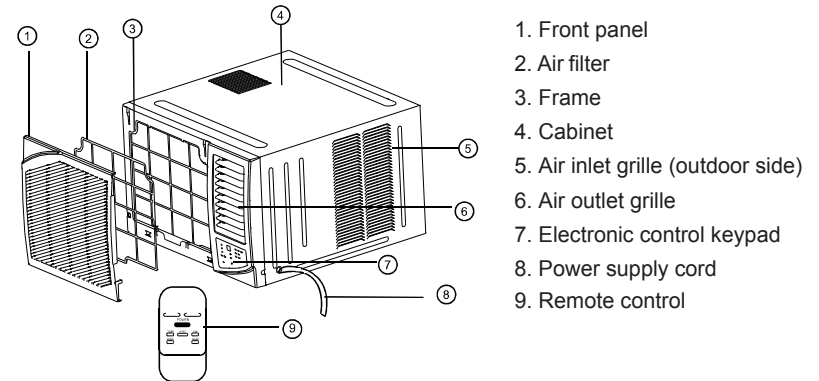

Remote for Remote model

1. Power cord conductors are distinguished according to color as follows (see Fig.1)
2. For your safety and protection, this unit is earthed through the power cord (see Fig.2)
Please contact the manufacturer or its service agent or a similar qualified person if you want to replace it.
3. Be sure that the unit is correctly grounded. The wall outlet (Air-break switch) should be provided with reliable earth wire.
4. The unit should be provided with an individual circuit and the circuit breaker/fuse rating should be the same as that of the power cord and wall outlet.

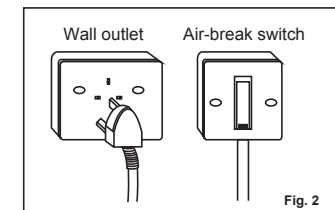
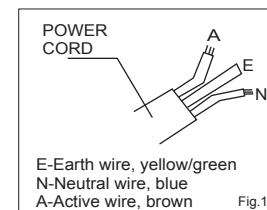

Accessories

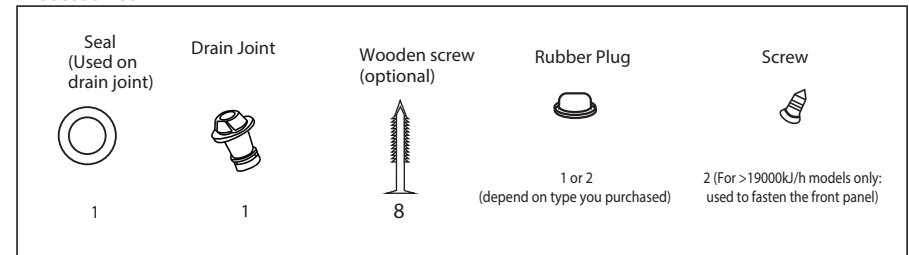

NOTE All the illustrations in the manual are for explanation purpose only. Your air conditioner may be slightly different. The actual shape shall prevail.

AIR CONDITIONER FEATURES

Control Panel

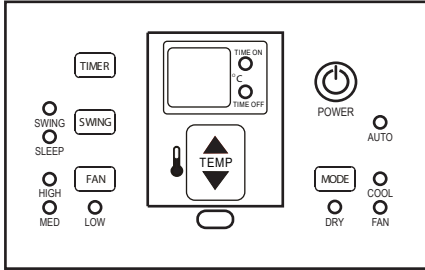

Vent Control

The vent control is located above the control knobs. The operation method is different on different models (see the following figures). For maximum cooling efficiency, CLOSE the vent. This will allow internal air circulation. OPEN the vent to discharge stale air.

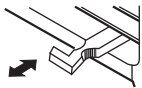

CLOSE → VENT → OPEN

To open the vent, pull the lever toward you
To close it, push it in.

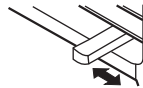

CLOSE ← OPEN

To open the vent, set the lever to the right position
To close it, set the lever in the left position.

NOTE: The VENTILATION LEVER should normally be kept in the CLOSED position during cooling for maximum cooling effect. The "OPEN" position is used only for ventilation.

Vertical air flow adjustment (manually)



To adjust vertical air flow direction, adjust any one of the horizontal louvre blades. When adjusting the horizontal louvre blades up or down, always keep the top or bottom blades horizontal. This can effectively prevent water droplets condensing on the front panel of the unit.

Air Filter

The air filter behind the inlet grille should be checked and cleaned at least once every 2 weeks (or as necessary) to maintain optimal performance of the air conditioner.

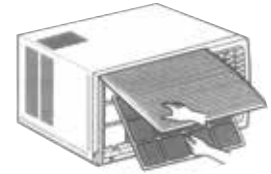

How to remove the air filter

1. Hold the slot under the front panel, then uplift it outwards, and remove the front panel.
2. Pinch the handle under the air filter and make the air filter arched, remove it from the slot from underside to upside.
3. Clean the filter with warm, soapy water. The water should be below 40 °C to prevent distortion of the filter.
4. Rinse off and gently shake off excess water from the filter. Allow the filter to dry before replacing it. To prevent distortion of the filter, do not dry in direct sunlight.

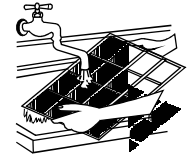

Drainage

See the following procedures to perform back drainage:

1. Fit the seal onto the drain joint (provided with your air conditioner as accessory.)
2. Remove the rubber plug from the back of the unit (if applicable) and insert it into the bottom drain hole.
3. Attach the drain joint to the back of the cabinet where you removed the plug and rotate it 90° to securely assemble them.
4. Connect the drain joint with an extension drain hose (locally purchased)

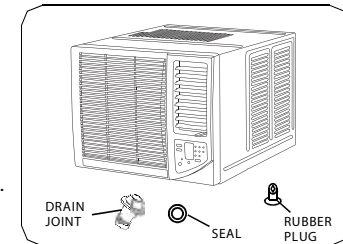

Note: If you choose non-drainage when cooling, both the bottom and the back drain holes of the unit should be inserted with rubber plugs. When you choose non-drainage, the air conditioner will give optimal cooling efficiency, but the unit may have a splashing sound due to the blower wheel hitting the accumulated water gathered in the base pan. The water then hits the condenser, and this results in a higher cooling efficiency.

Failure Indicator Display:

- E0: Indoor EEPROM error;
- E1: Indoor & outdoor communication error;
- E3: Indoor fan motor speed out of control;
- E4: Room temperature sensor error;
- E5: Evaporator temperature sensor error;
- EC: Refrigerant leakage detection;
- F0: Current overload protection;
- F1: Outdoor temperature sensor error;
- F2: Condenser temperature sensor error;
- F3: Exhaust temperature sensor error;
- F4: Outdoor electric EE error;
- P0: IPM module error;
- P1: Voltage too high/too low protection;
- P2: Protection of IPM high temperature;
- P3: Protection of outdoor temperature too low (For the Cooling & Heating models);
- P4: Protection of compressor location;
- P7: Outdoor IGBT sensor error.

Note: When one of the above malfunctions occurs, turn off the unit, and check for any obstructions. Restart the unit, if the malfunction is still present, turn off the unit and unplug the power cord. Contact the manufacturer or its service agents or a similar qualified person for service.

Other features:

Auto-Restart (on some models)

If the unit breaks off unexpectedly due to the power cut, it will restart with the previous function setting automatically when the power resumes.

Wait 3 minutes before resuming operation

After the unit has stopped, it can not be restarted operation in the first 3 minutes. This is to protect the unit. Operation will automatically start after 3 minutes.

Turbo function

Press the TURBO button by remote controller on COOL/HEAT (For models adopts Electrical heater only) mode, the air conditioner goes into powerful cooling/heating operation. Press again to cancel the TURBO function.

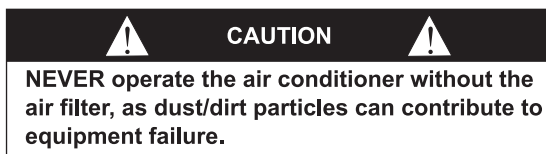

HANDLING THE REMOTE CONTROLLER

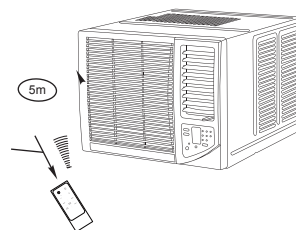

Location of the remote controller.

Use the remote controller within a distance of 5 meters from the appliance, pointing it towards the receiver. Reception is confirmed by a beep.

CAUTIONS

- The air conditioner will not operate if curtains, doors or other materials block the signals from the remote controller to the unit.
- Prevent any liquid from falling into the remote controller. Do not expose the remote controller to direct sunlight or heat.
- If the infrared signal receiver on the indoor unit is exposed to direct sunlight, the air conditioner may not function properly. Use curtains to prevent direct sunlight on the receiver.
- If other electrical appliances react to the remote controller, either move these appliances or consult your local dealer.

Installation instructions of battery

Step 1: Insert a coin vertically in the groove on the battery cover, clockwise rotation of 45 degrees, make sure that the groove is aligned with the "unlock" sign as shown below and remove the battery cover.

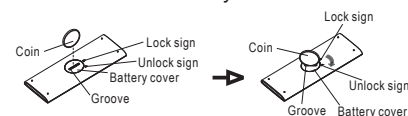

Step 2: Install battery inside the remote controller, the positive (+) side up.

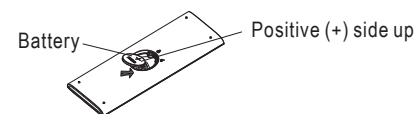

Step 3: Install the battery cover, make sure the battery cover groove is aligned with the "unlock" sign. Insert a coin vertically in the groove and press it gently, then counter clockwise rotation of 45 degrees, make sure the groove is aligned with the "lock" sign as shown below.

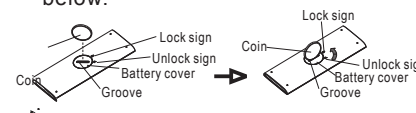

WARNING

1. Battery must be disposed of properly. Do not short circuit or dispose of in the fire.
2. Keep batteries out of the reach of children.
3. Caution for ingestion.
4. Non-rechargeable batteries are not to be recharged.
5. Exhausted batteries are to be removed from the product.

Remote Contoller Specifications

Model	RG15A1(B)/E, RG15A2(B)/E,
Rated Voltage	3.0V(Dry batteries Lr03x2)
Lowest Voltage of CPU Emitting Signal	2.4V
Signal Receiving Range	5m
Environment	-5°C~60°C

NOTE:

- Buttons design is based on typical model and might be slightly different from the actual one you purchased, the actual shape shall prevail.
- All the functions described are accomplished by the unit, if the unit has no this feature, there is no corresponding operation happened when press the relative button on the remote controller.
- When there are wide differences between "Remote controller Illustration" and "USER'S MANUAL" on function description, the description on "USER'S MANUAL" shall prevail.

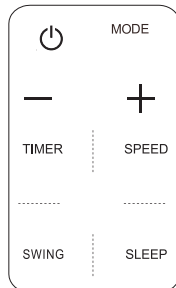

RG15A1(B)/E

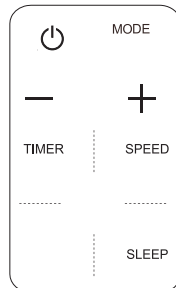

RG15A2(B)/E

Function buttons

ON/OFF button

Operation starts when this button is pressed and stops when the button is pressed again.

MODE button

Press this button to select the desired operation mode.

TEMP DOWN button

Push this button to decrease the indoor temperature setting.

TEMP UP button

Push this button to increase the temperature setting.

TIMER button

Push this button to activate the "Auto Start" or "Auto Stop" program.

FAN button

Used to select the desired fan speed.

SWING button

Upon pushing SWING button, the vertical louvres will swing automatically from side to side. Press it again to deactivate the "SWING" feature. (on some models)

SLEEP button

Press this button to activate the Sleep mode. This function is available on COOL, or AUTO mode only and maintain the most comfortable temperature for you while saving energy.

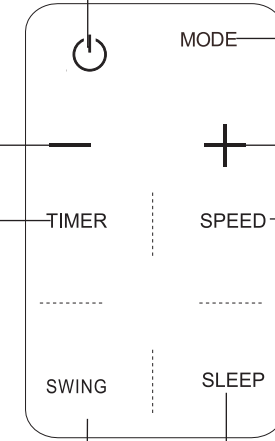

How to use the buttons

Auto operation

Ensure the unit is plugged in and power is available.

1. Press the ON/OFF button to start the air conditioner.
2. Press the MODE button to select Auto.
3. Press the TEMP UP/DOWN button to set the desired temperature.

NOTE

1. In the Auto mode, the air conditioner can logically choose the modes of Fan and Cooling by sensing the difference between the actual ambient room temperature and the set temperature on the remote controller.
2. You cannot change the fan speed in auto mode. it has already been automatically controlled.
3. If the Auto mode is not comfortable for you, the desired mode can be selected manually.

Coolin/Fan operation

Ensure the unit is plugged in and power is available.

1. Press the ON/OFF button to start the air conditioner.
2. Press the MODE button to select Cool or Fan mode.
3. Press the TEMP UP/DOWN button to set the desired temperature.
4. Press the FAN button to select the fan speed.

NOTE

In Fan mode, the setting temperature is not displayed in the remote controller and you are not able to control the room temperature either. In this case, only step 1, 2 and 4 may be performed.

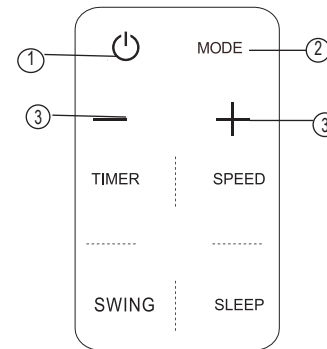
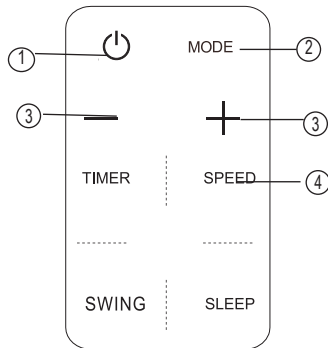
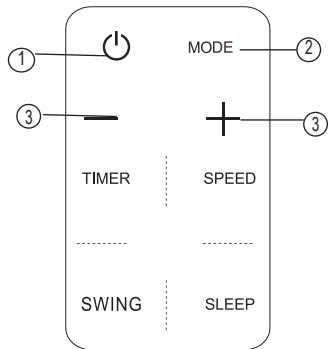

Dehumidifying operation

Ensure the unit is plugged in and power is available.

1. Press the ON/OFF button to start the air conditioner.
2. Press the MODE button to select Dry.
3. Press the TEMP UP/DOWN button to set the desired temperature.

NOTE

In the Dehumidifying mode, you cannot change the fan speed. It has already been automatically controlled.

Timer operation

Press the Timer button to set the Auto-Start and Auto-stop time of the unit. Auto-start/ Auto-stop programs can be set from 0-12 hours.

NOTE:

To set Auto-start time, the unit must be in the Off position.

To set Auto-stop time, the unit must be in the On position.

To set the Auto-start/stop time.

1. Press the TIMER button, when the TIMER ON indicator displayed on the LED window of the air conditioner, it indicates the Auto Start setting program is initiated. When the TIMER OFF indicator displayed on the LED window of the air conditioner, it indicates the Auto Stop setting program is initiated.
2. Press or hold the Up(▲) or Down(▼) to change the Auto time. The control will count down the time remaining until start/stop.

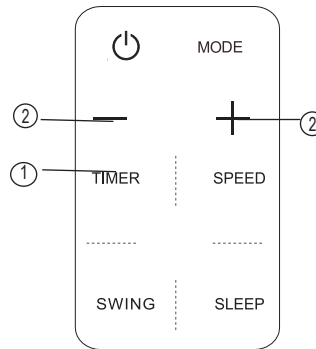

- The selected time will register in 5 seconds and the air conditioner will automatically revert back to display the previous temperature setting.
- Turning the unit ON or OFF at any time will cancel the Auto Start/stop function.

NOTE: To cancel the TIMER setting, push the TIMER button and press or hold the Up (▲) or Down (▼) until 0 hour is displayed on the LCD window of the air conditioner.

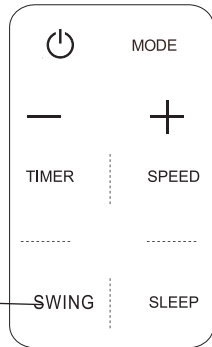

Swing operation

Use the SWING button to adjust the Left/Right airflow direction.

- Pressing this button while the unit is operational will make the vertical louvers automatically swing right and left, sweeping the cold/hot air alternately to obtain comfortable cooling/heating.
- Press the SWING button again to stop the swing operation.

INSTALLATION INSTRUCTIONS

Select the Best Location

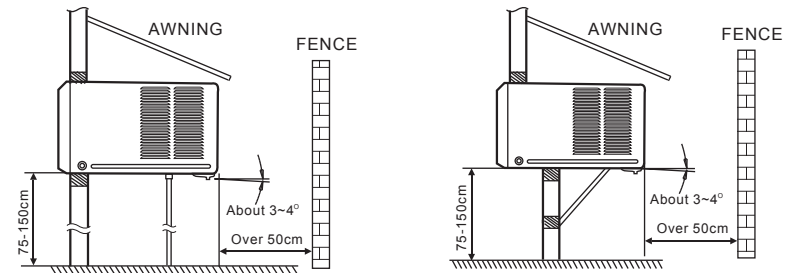

- To avoid vibration and noise, make sure the units is installed securely and firmly.
- Install the unit where the sunlight does not shine directly on it. If the unit receives direct sunlight, build an awning to shade the cabinet.
- There should be no obstacle, such as a fence or wall within 50 cm from the back of the cabinet because it will prevent heat radiation on the condenser. Restriction of outside air will greatly reduce the cooling efficiency of the air conditioner.
- Install the unit a little obliquely outward so the condensed water will not leak into the room (about 3~4° with level).
- Install the unit with its bottom portion 75~150 cm above the floor level.
- The power cord must be connected to an independent circuit. The yellow/green wire must be grounded.

CAUTION

All side louvers of the cabinet must remain exposed to the outside of the structure.

Installation of the Housing

Step 1

Remove the air conditioner from its packaging, remove fixing screws and slide the air conditioner out from the housing. (Refer to Installation Steps).

Step 2

Prepare the hole in the wall so that the bottom of the housing is well supported, the top has minimum clearance and the air inlet louvers have clearance as shown below in options A and B. Holes from the outside through to the cavity should be sealed. The housing should slope down towards the rear by about 5mm to allow water formed during operation to drain.

Step 3

Install the housing into the wall and ensure the foam seals are not damaged. Seal or fill the gaps around the inside and outside to provide satisfactory appearance and protection against the weather, insects and rodents.

Note: Unit may be supported by a solid frame from below or by a hanger from a solid overhead support.

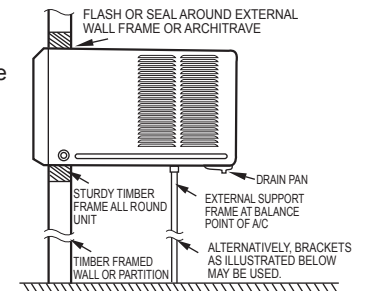

Preferred method of installation into a timber framed wall, partition or window.

Installations of the unit into the housing

Step 1

Slide the unit into the housing until it is firmly against the rear of the housing. Care is required to ensure the foam sealing strips on the housing remain in position.

Step 2

Connect the air conditioner to the power and position the excess cord length beneath the air conditioner base.

Step 3

Engage the chassis fixing brackets into the bottom housing rail and secure to the base with the screw provided.

Step 4

Remove the front panel from its carton and plastic bag and fit as per the Installation Instruction.

Step 5

Switch unit on. Check for operation of the unit and check for vibration in the installation.

Step 6

Fit the drain pan to the housing and run a drain line to a suitable location if required.

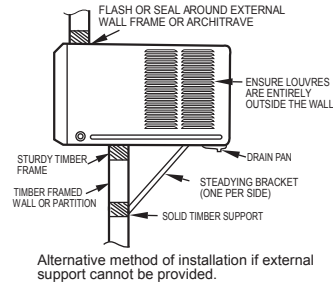

Installations of the unit into the wall

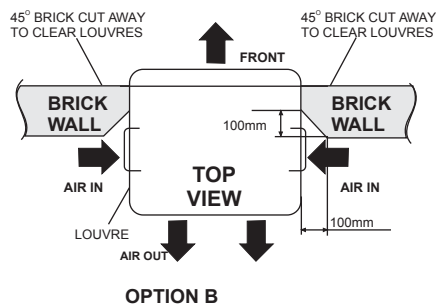
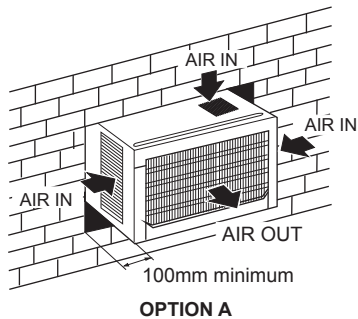

Installations steps

Step 1. Remove the front panel and the air filter

- Hold the slot under the front panel, then uplift it outwards, and remove the front panel (See Fig.1).
- Pinch the handle under the air filter and make the air filter arched, remove it from the slot from underside to upside (See Fig.2).

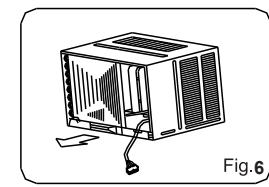
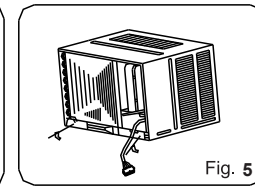
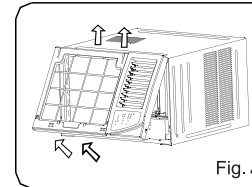
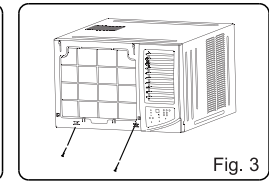
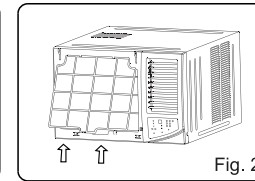
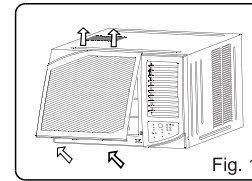

Step 2. Remove the frame

- Remove the two fixing screws from the frame (See Fig.3).
- Grasp the left corner of the frame's underside, release the coupler plugs, then loosen the frame (See Fig.4).

Step 3. Installation

- Remove the two fixing screws on the chassis fixing brackets, then remove the chassis fixing brackets (See Fig.5).
- Grasp the handle on the chassis and carefully slide the air conditioner out of the cabinet (See Fig.6).
- Remove shipping pad from around compressor before operation and make sure the discharge points to the

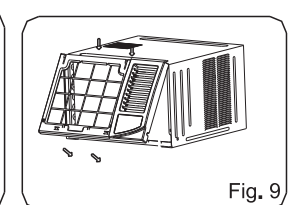
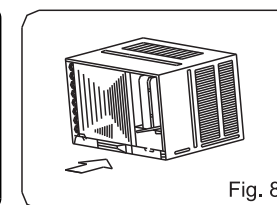
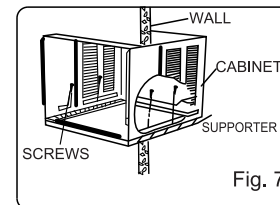

Step 4. Install the frame

Fix the screws on the frame (See Fig.3).

Step 5. Install the air filter and front panel

- Install the air filter into the frame's slot from upside to underside (See Fig.2).
- Hang the front panel on the frame's buckle, then press the front panel into the frame's slot until you hear a click (See Fig.10).

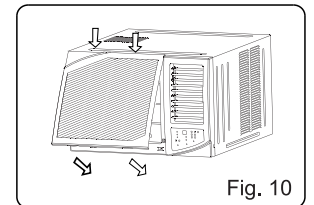

CARE AND CLEANING

CAUTION

Clean your air conditioner occasionally to keep it looking new. Be sure to unplug the unit before cleaning to prevent shock or fire hazards.

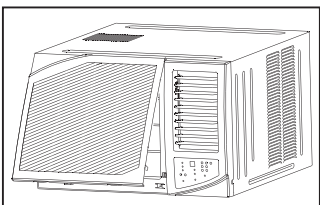

Air Filter Cleaning

The air filter should be checked at least once a month to see if cleaning is necessary. Trapped particles in the filter can build up and cause an accumulation of frost on the cooling coils.

- Hold the slot under the front panel, then uplift it upwards, and remove the front panel.
 - Pinch the handle under the air filter and make the air filter arched, remove it from the underside to upside.
 - Wash the filter using liquid dishwashing detergent and warm water. Rinse filter thoroughly.
 - Gently shake excess water from the filter. Be sure the filter is thoroughly dry before putting it back.
 - Or, instead of washing you may vacuum the filter to clean.
- Note: Never use hot water over 40°C (104°F) to clean the air filter. Never attempt to operate the unit without the air filter.

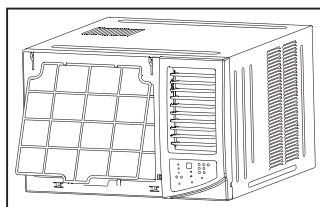

Cabinet Cleaning

- Be sure to unplug the air conditioner to prevent shock or fire hazard. The cabinet and front panel may be dusted with an oil-free cloth or washed with a cloth dampened in a solution of warm water and mild liquid dishwashing detergent. Rinse thoroughly and wipe to dry.
 - Never use harsh cleaners, wax or polish on the cabinet and front panel. Be sure to wring excess water from the cloth before wiping around the controls.
 - Excess water in or around the controls may cause damage to the air conditioner.
 - Plug in air conditioner.
- Note: Never use water over 50°C, alcohol, gasoline, acid, solvent or brush to clean the

TROUBLESHOOTING

Troubleshooting Tips

Save time and money! Review the chart below first and you may not need to call for service.

Normal Operation

- You may hear a pinging noise caused by water being picked up and thrown against the condenser on rainy days or when the humidity is high. This design feature helps remove moisture and improve efficiency.
- You may hear the thermostat click when the compressor cycles on and off.
- Water will collect in the base pan during high humidity or on rainy days. The water may overflow and drip from the outdoor side of the unit.
- The fan may continue to operate when the compressor has cycled off.

Abnormal Operation

Problem	Possible Causes	What To Do
Air conditioner does not start	■ <i>The air conditioner is unplugged.</i>	● Make sure the air conditioner plug is pushed completely into the outlet and switched on.
	■ <i>The fuse is blown/circuit breaker is tripped.</i>	● Check the house fuse/circuit breaker box and replace the fuse or reset the breaker.
	■ <i>Power failure.</i>	● If power failure occurs, switch off and disconnect /unplug the power cord. When power is restored, reconnect (plug in) the power cord, switch on the power and wait 3 minutes to restart the air conditioner to prevent tripping of the compressor overload.
Air conditioner does not cool as it should	■ <i>Airflow is restricted .</i>	● Make sure there are no curtains, blinds, or furniture blocking the front of the air conditioner.
	■ <i>The air filter is dirty.</i>	● Clean the filter at least every 2 weeks. See the operating instructions section.
	■ <i>The room may have been hot.</i>	● When the air conditioner is first turned on you need to allow time for the room to cool down.
	■ <i>Cold air is escaping.</i>	● Check for open furnace floor registers and cold air returns. ● Set the air conditioner's vent to the closed position.
Air conditioner freezing up	■ <i>Cooling coils have iced up.</i>	● See Air Conditioner Freezing Up below.
	■ <i>Ice blocks the air flow and stops the air conditioner from cooling the room.</i>	● Set the fan at MED or HIGH until the ice melts.