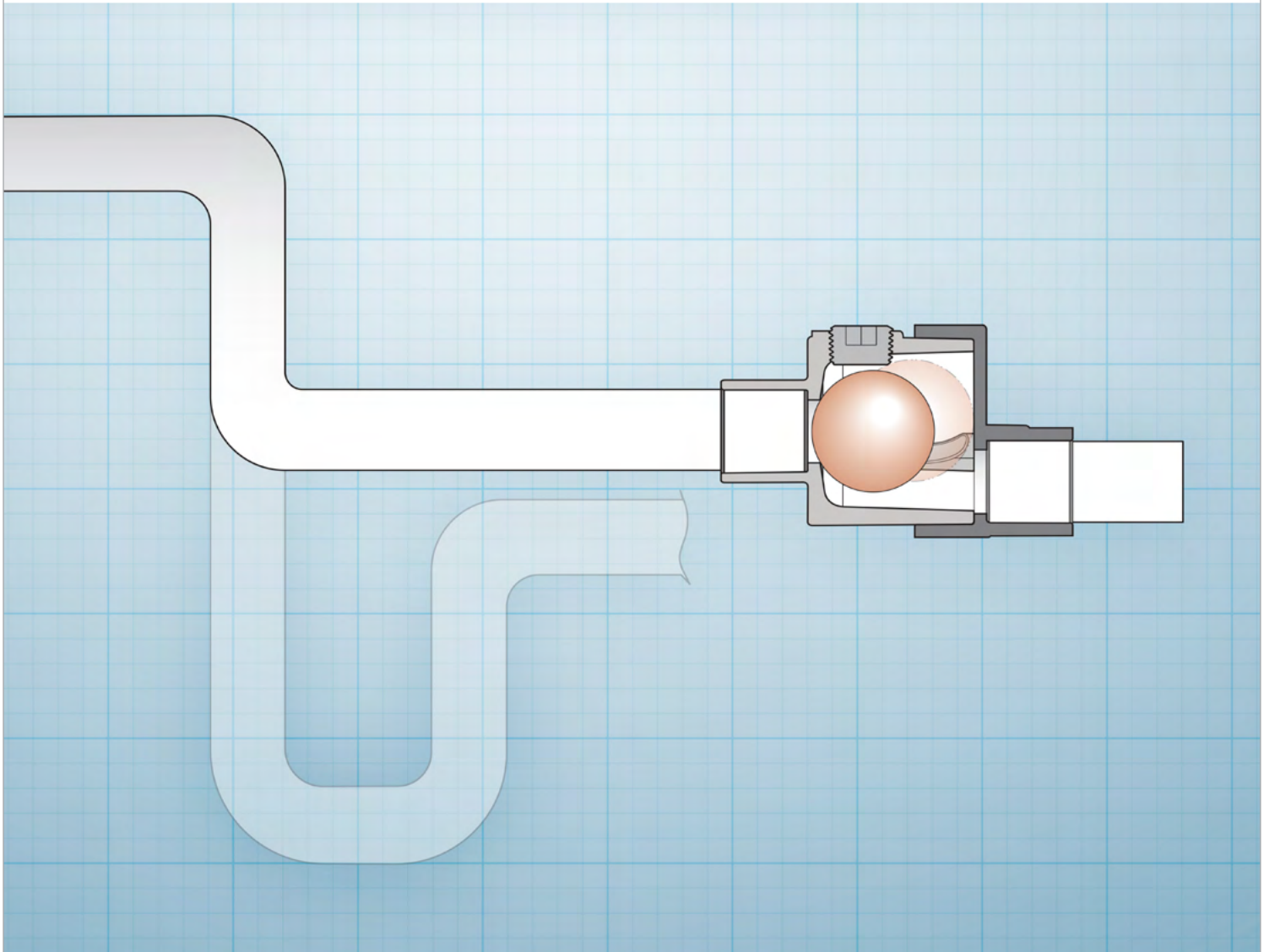
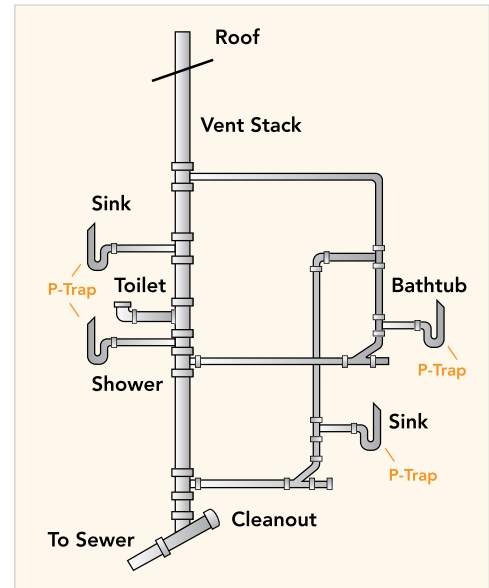


# It's Time to Reconsider the Use of P-Traps for HVAC Condensate Removal



Nicholas H. Des Champs, Ph.D., PE, ASHRAE Fellow

When using a toilet to get rid of human waste or a sink to wash vegetables, the discarded product ends up in the same sewer line prior to its destination, the septic tank or sewage treatment plant. Obviously, you would not want the gases from the toilets to penetrate the kitchen where food is being prepared so an airtight seal is required between the appliances and the sewer line. Since the end of the 19th century, P-Traps have been used successfully for this purpose, for each incident enough water flows through the trap to move the waste from the source to the sewer while leaving water within the trap as a seal against air flow (refer to the diagram at right showing a piping arrangement that directs all household waste to a sewer connection). There are problems associated with the P-Trap when used in disposal systems, such as dry-out or freezing, but the benefits outweigh them.



Since P-Traps seal against air leakage, they were the natural solution to prevent air leaking at the condensate drains of early 1900s air conditioning units. As air conditioning caught on in the 50s, P-Traps were the standard that every contractor field designed and installed, even if it was unknown to them whether the drain pan was at negative or positive pressure, or even at what level of pressure. It is still that way today. Air conditioning units are shipped from the factory to the job site without a condensate drain trap. The AC equipment is set on the slab, floor, or curb and it is the mechanical contractor’s job to install a P-Trap. Presently, most plumbing codes call for the use of a P-Trap on all appliances that are connected to a sanitary sewer. The only code requirements for drain lines removing condensate from HVAC equipment are:

- a) for the installation of a trap in accordance with the unit manufacturer’s installation and operating instructions
- b) that the lines slope toward the final drainage point at a rate of 1/8 inch per foot and
- c) that the size of the drainpipe meet the below requirements:

Size (tons)	0 - 20	21 - 40	41 - 60	61 - 100	101 - 250	251 & larger
Minimum Condensate Drain Size (inches)	3/4 to 1	1-1/4	1-1/2	2	3	4

The manufacturer’s instructions usually call for the line to be cleanable. More than likely, there will be no instructions or trap installation guidelines included within the HVAC unit installation manual. The information the engineer or contractor requires to properly design and install a HVAC condensate drain line with a standard P-Trap is:

1. Does the fan draw through the cooling coil (negative drain pan pressure) or blow through the cooling coil (positive drain pan pressure)?
2. The maximum operating pressure across the trap, i.e. drain pan compartment to ambient.
3. Maximum gallons of condensate per hour, required to size the drainpipe.
4. Inches per month water evaporation rate for the geographic area.
5. Greatest interval of time that condensate will not be produced (to determine depth of trap to prevent dry out).
6. Will the drain piping require a vent pipe immediately downstream of the condensate trap to prevent siphoning action?
7. Design guide for P-Traps

## P-Trap Design Guide

Information that will aid the specifying engineer or contractor in the design and installation of a condensate line, using the standard P-Trap, is provided below.

### Cooling Coil Draw-Through Arrangement - Condensate Drain Pan Under Negative Pressure

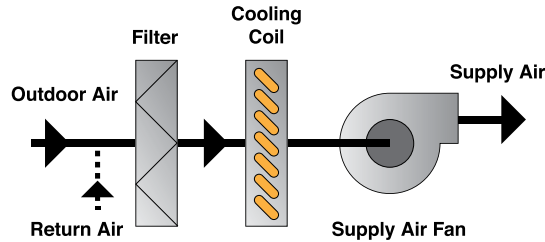


Figure 1a: Fan Off

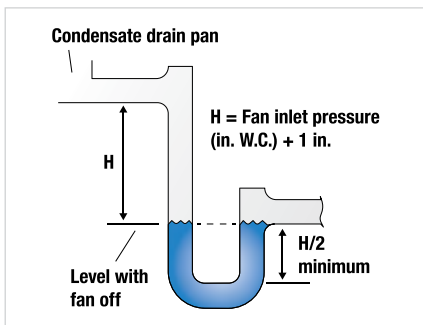


Figure 1b: Fan Just Started

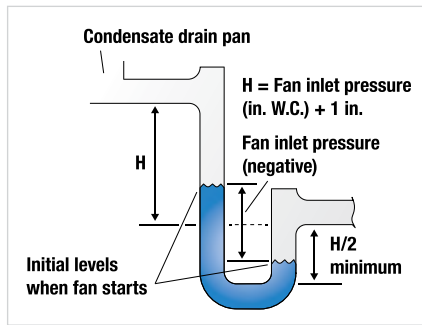
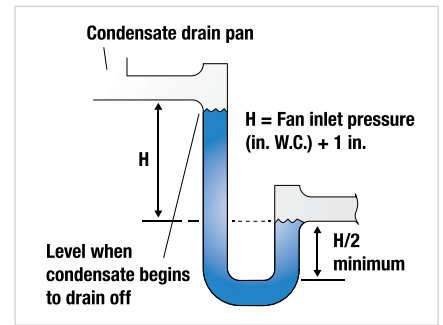


Figure 1c: Condensate Draining



### Cooling Coil Blow-Through Arrangement - Condensate Drain Pan Under Positive Pressure

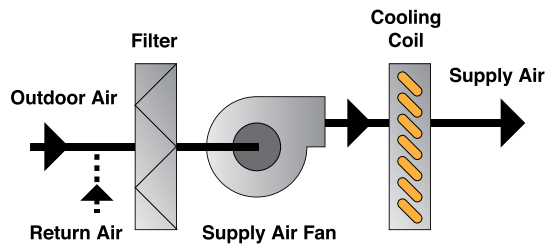


Figure 1d: Fan On - Condensate Beginning to Drain

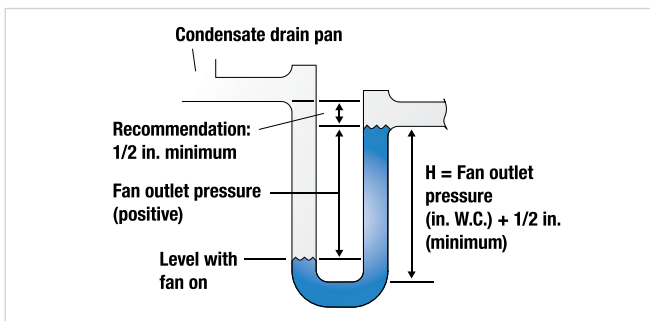
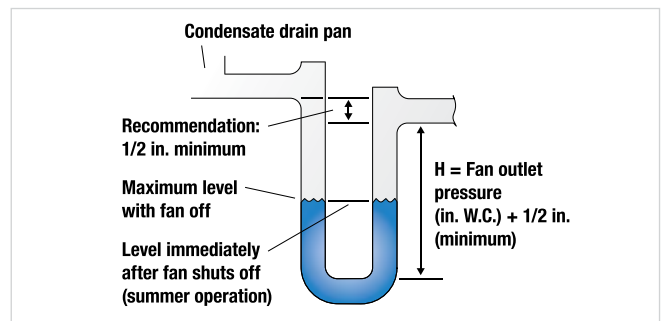


Figure 1e: Fan Off - High & Low Level



## Estimated Cooling Coil Condensate Flow

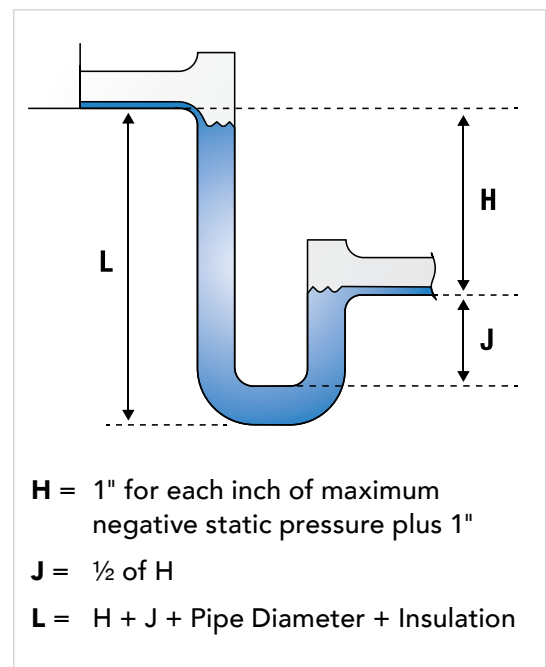
Range	Average	Unitary Packaged AC Equipment	Air Handling Units			
			Outdoor Air			
0.02-0.08 GPM/ton	0.04 GPM/ton	0.006 GPM/ton	100%	50%	25%	15%
			0.100/GPM /1,000 cfm	0.065/GPM /1,000 cfm	0.048/GPM /1,000 cfm	0.041/GPM /1,000 cfm

If a P-Trap is to seal against airflow for the entire year then there must be a water seal within the trap during the entire 365 days. To maintain a seal, the trap design must incorporate added height to accommodate water evaporation.

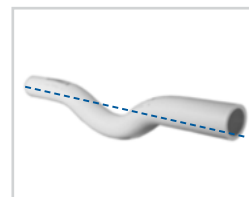
## Rate at Which Water Evaporates within a P-Trap

Tests by the author indicate water will evaporate at a rate of approximately 2.2 inches per month from late spring through early fall. It does not make a difference if the drainpipe is 3/4-inch in diameter or 1 1/2-inch, or from a 20' x 40' swimming pool, the water evaporates at an average rate of 2.2 inches in height per month. The readings were taken near Roanoke, VA. If there is a drain line of considerable length that has pockets of water within the line after condensate ceases, then the evaporation rate in a P-Trap could be as low as 1.1 inches per month. In arid regions the evaporation rate will be higher, up to 3 inches per month. For example, if you have a residence in Las Vegas (**Figure 5**), and you are gone for six weeks, the toilet will have dried out by the time you return. Basically, dry P-Traps waste considerable energy as will be presented in the following paragraphs. A typical P-Trap design for draw-through equipment is shown in **Figure 2**. For a system operating at 1/2 inches of negative pressure, J will be 1 1/4 inches of height, which with an evaporation rate of 2 inches per month the seal will be lost after just two weeks of noncondensing operation! This is good reason to believe that P-Traps in most of the country run dry over 50% of the time.

Even worse is what has almost become standard for P-Traps in residential applications, a 3/4" bent PVC tube as shown in **Figure 3a**. With the trap set level and filled with water a test was run to see at what pressure the trap would cease to seal against air flow. The pressure was gradually increased from zero to the point where the water began to gurgle within the trap. For the inline trap a



**Figure 2: Accepted Design for a Negative Pressure P-Trap**



**Figure 3a: Molded Trap made from a 3/4" PVC Pipe**



**Figure 3b: Molded 3/4" P-Trap**

pressure of  $\frac{5}{8}$ " WC caused the air seal to break. For the trap shown in **Figure 3b** it took 2 days to pass air at  $\frac{5}{8}$ " WC. Both tests were run at 75°F and 50%RH.

The standard design for a P-Trap, as shown in **Figure 2**, does not fully take into consideration the evaporation of water from the trap over time. As already mentioned, a trap must seal against air leakage all year. For it to do that, two things must be taken into consideration: First, it must be designed with a water reservoir sufficiently deep or large to ensure the water seal is not evaporated away. Second, the water reservoir must be protected from freezing. Therefore, instead of H being equal to 1" for each inch of maximum negative static pressure plus 1", it should be 1" for each inch of maximum negative static pressure plus 1" + (N x E), where N = number of months without condensate being formed and E = the average evaporation rate of water in inches per month during the non-condensing period.

As an example, take an AC unit in Roanoke, VA, operating at 1-inch negative pressure, that is typically cooling from May through September, or five months of the year. That's seven months of no condensate formation. Referring to **Figure 4**, from October to April the average evaporation rate of the condensate is about 1.5 inches per month.

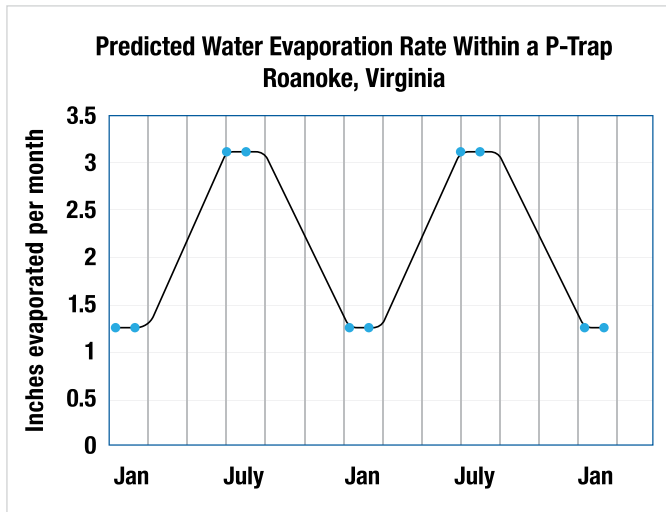


Figure 4

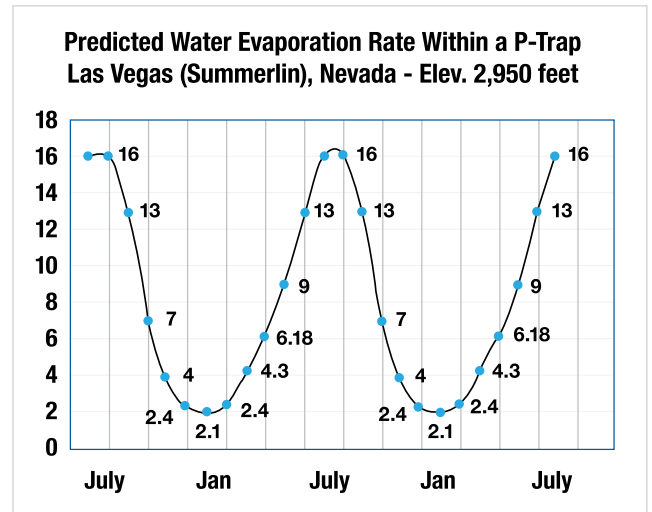


Figure 5

Using the revised formula:

$$H = 1 + 1 + (7 \times 1.5), \text{ or } 12.5 \text{ inches.}$$

$$J = \frac{1}{2} H = 6.25 \text{ inches.}$$

Therefore, the height of the trap  $L = H + J + \text{pipe diameter} + \text{insulation}$

- or -

$$L = 12.5 + 6.25 + \frac{3}{4} + \frac{1}{2} \text{ or } 20 \text{ inches.}$$

Yeah, "really" you say. Well, I say check a residential trap in April before cooling season, anywhere except in Florida, and see if it has a water seal.



The picture to the left shows three P-Traps that have been removed from an attic heat pump air handler. All were replaced when AC service persons “solved a ceiling and wall flooding problem”. He said the traps had frozen, but as later discovered none were broken. What happened was the original installer did not connect a drain line to the safety pan under the unit. As a result, come spring, air sucked into the main drain pan area and caused a water geyser to occur as the air rushed in and the condensate tried to escape. The geyser caused water to overflow into the safety pan, but with no line to the final drain it ended up in a bathroom. The AC unit now has a proper fix: no air leakage, no condensate evaporation, no geyser, no chance of freezing, and no sludge buildup. It has a Des Champs HVAC Air-Trap™ RLC-Series.

The test stand used to determine the graphs shown in **Figures 4 and 5** is shown in **Figure 6**. The results of the evaporation tests do not include two important factors:

1. For an installed trap, when the fans are operating, there is air flow over the drain leading to the trap, which would have a tendency to increase evaporation.
2. On the downstream side of the trap, there could be water sitting in the line and/or the drain line could extend a considerable distance before reaching its final destination, both instance leading to less evaporation.

Therefore, the results shown in **Figures 4 and 5** are an estimate of evaporation rate. It is known that condensate traps used in data center cooling equipment, that are designed to principally cool the DC using indirect air-side economization, but have backup mechanical cooling, must add water to the trap every several weeks to maintain an air seal. This issue led to the development of the **Des Champs HVAC Air-Trap™**, a trap product that does not require standing water to ensure an air seal. More on the HVAC Air-Trap when we compare the energy loss resulting from air leakage of P-Trap to that of the HVAC Air-Trap. But, before we get to the cost advantages of the HVAC Air-Trap compared to the P-Trap, let’s explore a real example of what takes place in the trap world. A contractor recently replaced five RTUs on our office building that were not that old but needed replacement because of considerable rust in the cooling section caused by ambient air being sucked in through the drain opening and preventing the condensate from flowing out of the drain into the drain line. The five replaced RTUs were all connected to a central drain line and none were trapped.



**Figure 6: Test stand for measuring evaporation of water at different conditions**




**Figure 7: Des Champs HVAC Air-Trap RLC-Series**

Rusting, deterioration of thermal insulation, bearing failure, shorting of fan motor, and wet interior office ceilings were all caused by the water geyser that results when water is attempting to escape from the drain, but the rush of incoming air blows the condensate throughout the cooling coil and fan compartment. The new installation, **Figure 7** is correctly installed with the new HVAC Air-Traps placed between the RTU and the main drain line.

Many installations do not allow for the proper P-Trap design because there is not enough height to have the trap retain the necessary amount of water to prevent dry-out. In fact, the trap will fail to operate properly at some point during the year. If the unit is in a tropical environment the P-Trap, with proper design can operate all year if cleaned on a regular basis to remove the sludge and growth buildup at the bottom of the trap. If installed in the arid west it will not seal against air flow for most of the year unless the P-Trap is primed on a regular basis (the trap will dry out at the rate of over 2 inches per month). In other areas of the country, the trap will either freeze and break or with no water will pass air. If heat tape is applied to keep the trap from freezing, then it's almost guaranteed the trap will be dry during winter months. As an example, for a trap to not dry out, and pass air, it would have to be designed to hold at least 8 inches of water at the end of a cooling season to seal air during the heating season and operate properly at the beginning of the next cooling season: this would require thermal insulation or heat tracing if the trap is exposed to freezing temperature. Basically, when using a P-Trap to remove condensate from an HVAC unit, you will encounter considerable air leakage to or from the occupied space during a year. The author's estimate of the percentage of time that a P-Trap operates dry is: South and Southeast 10% to 40%, Northeast 50%, North 60%, and West 80% plus. Contractors also tend to forget about energy losses when it comes to positive pressure applications.

Because the geyser problem does not exist with positive pressure P-Traps, it is much easier to simply leave the trap out of the drain line (**see Figure 8 below**). This tends to create a negative pressure in the conditioned space which would draw cold air in during the winter and hot, humid air in the summer. Both seasons will have moisture condensing within the building thermal insulation. Drain lines without traps were not taken into consideration in the above estimate of leakage and the below estimate of energy loss.



**Q** An expert HVAC contractor (Professional Member) answers the question: *Do you need a vent stack?*

**A** *"If your drain is on the positive side of the system, you don't even need the stack vent so yes you can cap it. I do it all day every day and never have any drain problems. You also don't need a drain trap on the positive side of the system. If you are using an air handler where the drain is on the negative side, you must have a trap. I make it a practice to just follow the installation instructions and local code."*

**A** *Another expert: "a positive pressure drainpipe is usually not an issue, just remove the trap."*

**Figure 8: Online advice from the experts, self-explanatory**

Air that leaks through a P-Trap has usually just been conditioned to cool or heat the space, so the energy lost is greater than for the same amount of room air leaking to ambient. It doesn't make any difference whether the conditioned air is being blown out of the unit (positive pressure) or drawn into the unit (negative pressure), the wasted air must be replenished, meaning that the makeup air must be filtered, and heated or cooled/dehumidified from ambient to supply air conditions, not return air conditions. Air is supplied at 55°F during cooling season and 110+ °F during heating. So, you are blowing air away at 55°F in summer and 110°F in winter.



# Comparison of Air Leakage Through a Dry P-Trap and a HVAC Air-Trap

## Leakage Rate of Air Through a Dry P-Trap

$$v = \sqrt{\frac{25,000 dp}{L}}$$

- v = velocity of air within drain line, ft/sec
- p = loss of pressure due to flow through the pipes, ounces/in<sup>2</sup>
- d = inside diameter of pipe, inches
- L = length of pipe, feet
- N = number of similar traps within conditioned space
- Qi = volumetric flow per trap, ft<sup>3</sup>/min
- Qt = total volumetric flow through N traps within conditioned space, ft<sup>3</sup>/min
- 25000 = unit conversion factor

p = 2.0 inches WC  
1.1552 ounces/in<sup>2</sup>

d = 1.00 in

L = 15.00 ft

N = 1

v = (25,000 \* p \* d/L)<sup>0.5</sup> ft/sec      Air velocity through drain line

v = 43.9 ft/sec  
2,632.7 ft/min      Velocity entering or leaving drain pan

Flow area = 0.0055 ft<sup>2</sup>      Drain line flow area

Qi = 14.4 ft<sup>3</sup>/min      Air flow to or from cooling unit through drain line per P-Trap

Qt = 14.4 ft<sup>3</sup>/min      Total air flow through N number traps: conditioned make-up air is required to replace this leakage

## Leakage Rate of Air Through an HVAC Air-Trap

The specific relationship among the pressure within the drain pan compartment, the ambient pressure, and the flow area between the float valve and the seat is expressed by the following equation:

Qi = 2610 \* A \* (ΔP) ^ 0.5

Where:

ΔP = pressure drop across ball valve seat, inches of water, which is = P1 - P2

A = open area for flow between the ball valve and the seat, ft<sup>2</sup>

2610 = unit conversion factor dimensionless

D = contact diameter between ball and seat, inches

D = 0.62 in

P1 = 2.00 in wc within drain pan

P2 = 0 in wc ambient

Peripheral Gap = 0.0005 in (average distance between float valve and seat)

A = 6.76317E-06 ft<sup>2</sup>

Qi = 0.025 ft<sup>3</sup>/min per HVAC Air-Trap™ (confirmed by measurement)

## Estimate of Energy Loss Through P-Traps Within the United States

### April through September (AC Operation or 182 days)

Assume: 14 cents/kW-hr

Assume: operating 50% of time — of that time 25% dry or 12.5% of time running dry during cooling season

Operating 50 percent of time

Percentage dry 25 during operation

Average  $\Delta T$ , F° 25 difference between conditioned supply air temperature and ambient

CFM from above calculation 14.4

$Q = 4.05 \times \text{CFM} \times (h_1 - h_2) = 915 \text{ Btu/hr per P-trap}$  or 0.268 kW

Using an average COP of 2.0 the energy in kW is 0.134 kW

Operating 50% of time — of that time 25% dry or 12.5% of time running dry

(Note: many installations have no traps installed)

Total kW-hrs per year per P-Trap at the above conditions = 70.4304

Total estimated energy cost per year per P-Trap = \$9.86

### October through March (Heating Operation or 183 days)

Operating 50 percent of time

Percentage dry 80

Average  $\Delta T$ , F° 70 difference between conditioned supply air temperature and ambient

CFM from above calculation 14.4

$Q = 1.085 \times \text{CFM} \times \Delta T = 1,088.6 \text{ Btu/hr}$

Assume operating 50% of time and 80% dry or 40% of time running dry and 80% efficient furnace.

Cost to heat lost air = \$9.56 per P-Trap

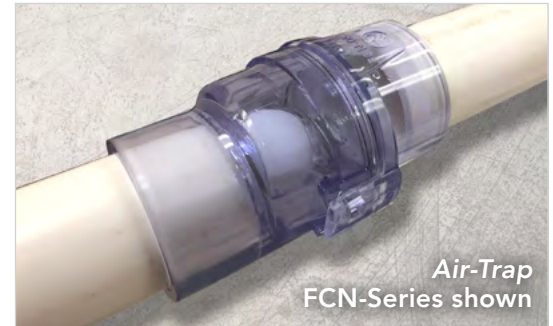
***Estimated cost to condition lost air through P-Trap: \$19.42 per average P-Trap per year***

***Estimated that there are 200,000,000 HVAC P-Traps installed in the United States***

***Cost in Energy Consumed resulting from air lost through P-Traps = \$3,884,573,952***

## Stop Wasting Energy, Switch to the HVAC Air-Trap™

Sealing this leakage should be seriously considered by energy-conscious owners, specifying engineers, installing contractors, and government officials. The quickest, easiest, and most cost-effective way to reduce the wasted energy is to replace the installed traps with Des Champs HVAC *Air-Trap* and specify them to be used on new installations. Not only would the HVAC *Air-Trap* be saving “tons” on energy, but you would be eliminating the eight issues inherent with P-Traps:



	Standard P-Trap Issues	HVAC Air-Trap™ Solution
1	Freezes and breaks	Operates dry when there is no condensate being produced, the trap and the drain line leading to the trap will not freeze
2	Dry-outs	Eliminates dry-out issue
3	Sludge formation at bottom of "U" tube	No accumulation of sludge. Operates dry when no condensate is flowing
4	Geyser effect of air rushing into drain pan and spraying water or causing overflow of drain pan	Eliminates geyser effect
5	Mold, mildew, and undesirable bacteria forming in the cooling-coil compartment	Prevents mold, mildew and undesirable bacteria by eliminating geyser effect which causes condensate to collect in the cooling-coil compartment
6	Air leakage	When removing water, the water exits the <i>Air-Trap</i> but no air escapes the unit.
7	Height requirement for trap to function properly	Less than ½ the height of a standard P-Trap
8	Incorrectly designed and installed	Predesigned — eliminating errors caused by field designed P-traps

Owners would really appreciate saving the energy and not dealing with the eight issues resulting from P-Traps as well as the consequences of malfunctioning, especially water running down their walls when the AC units start up in the spring, as the author has witnessed on numerous occasions before the invention of the *Air-Trap* in 2014.

The Des Champs HVAC *Air-Traps* come in all sizes and shapes to cover essentially any condensate requirement. The P and N Series for commercial applications, the RLC for residential and light commercial, the FCN series for residential, hotels, apartment houses, and the PLP for positive pressure application where pressures up to 30 inches WC or more can be accommodated in a height of less than 3 inches. These traps are shown below together with a sample installation guide in order to illustrate the size, shape, and function of the HVAC *Air-Traps*. Our website can lead you to all the information you will need to get you started switching to a product that will eliminate the problems with P-Traps and energy loss, and result in a satisfied customer.

[www.deschampstechnologies.com](http://www.deschampstechnologies.com) — [www.waterless-trap.com](http://www.waterless-trap.com)

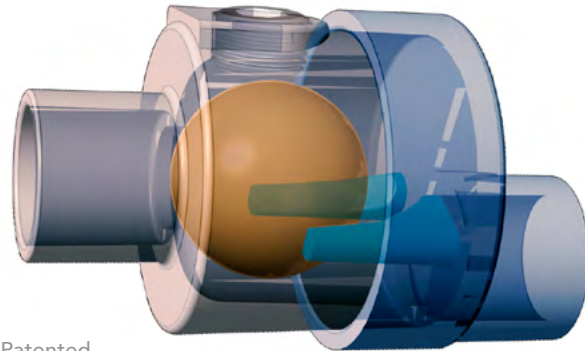
# RLC-Series HVAC Air-Trap™

## Residential / Lite Commercial — For Use as Negative or Positive Trap

### Negative Pressure

#### Orientation is Horizontal

- Condensate flow up to 4 GPM at any negative pressure
- Schedule 40 PVC with clean out port
- Retains no water after condensing has ceased
- 3/4" slip internal or 1" fitting external connection - with bushings can connect to 1/2, 1 1/4, 1 1/2 and 2" tubes
- Meets general building codes. For use on HVAC equipment only. Not for use as a sanitary trap.

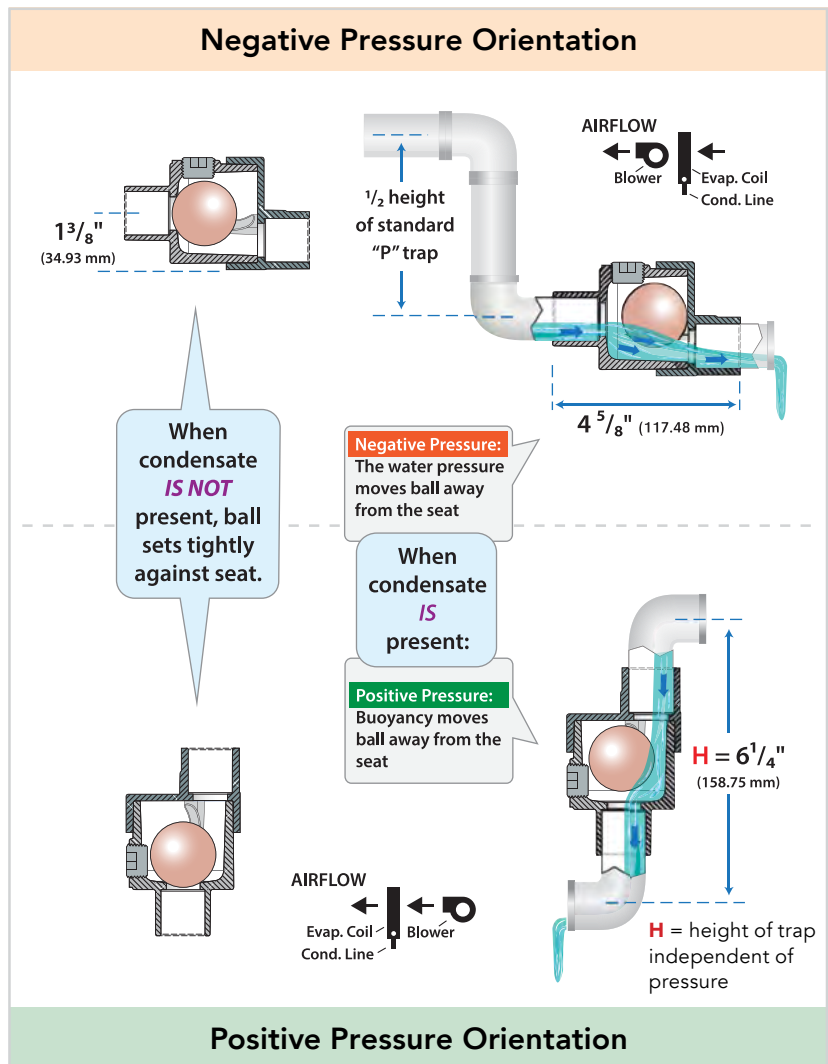


Patented

### Positive Pressure

#### Orientation is Vertical

- Up to 3-inches positive pressure
- Up to 0.5 GPM water flow (≈ 40 tons)



The Air-Trap™ concept has been incorporated into IAPMO IGC 196-2018 Standard for Condensate Traps and Overflow Switches for Air-Conditioning Systems.

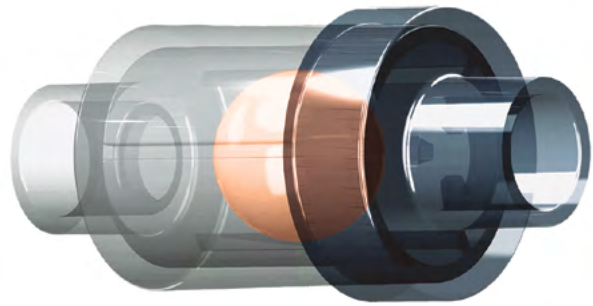
ICC-ES Evaluated



# N-Series HVAC Air-Trap™

## Negative Pressure Waterless Trap

**Figure 1:** Shows for a standard “P” Trap the vertical distance required between center lines of unit connection and the center line of the bottom of the trap is 4 inches when there is a 2-inch negative plenum pressure. By comparison, the *Air-Trap* N-Series is only 2 inches, not the 4 inches required with the standard “P” trap.

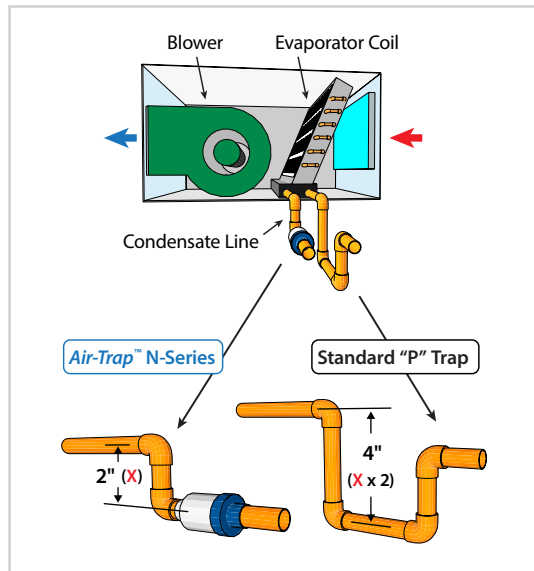


Patented

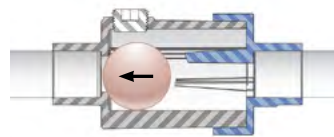
**Figure 2:** When condensation is not present, the negative pressure within the plenum draws the internal mechanism against the valve seat preventing air from entering the AHU through the drainpipe.

**Figure 3:** As condensate forms, water builds up in the vertical pipe. When the water pressure equals the negative air pressure in inches of water column, the force of the water head becomes equal or greater than the negative pressure — the internal mechanism moves to the right, and water flows.

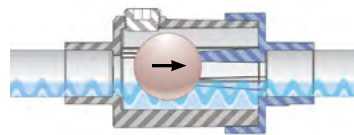
**Figure 4:** When there is no longer a requirement to remove condensation, the negative pressure returns the ball to the valve seat and prevents airflow to the unit plenum. The internal rails aid in returning the ball to the seat in case the variable speed fan is operating at a low flow and low negative pressure.



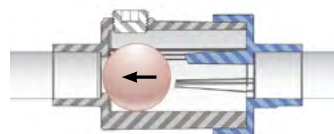
**Figure 1: Trap Required in Condensate Line**  
If the condensate drain line is under negative pressure (e.g., upstream of blower as shown here) a trap is required.



**Figure 2**

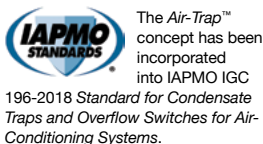


**Figure 3**



**Figure 4**

Available sizes: 3/4" 1" 1 1/4" 1 1/2"



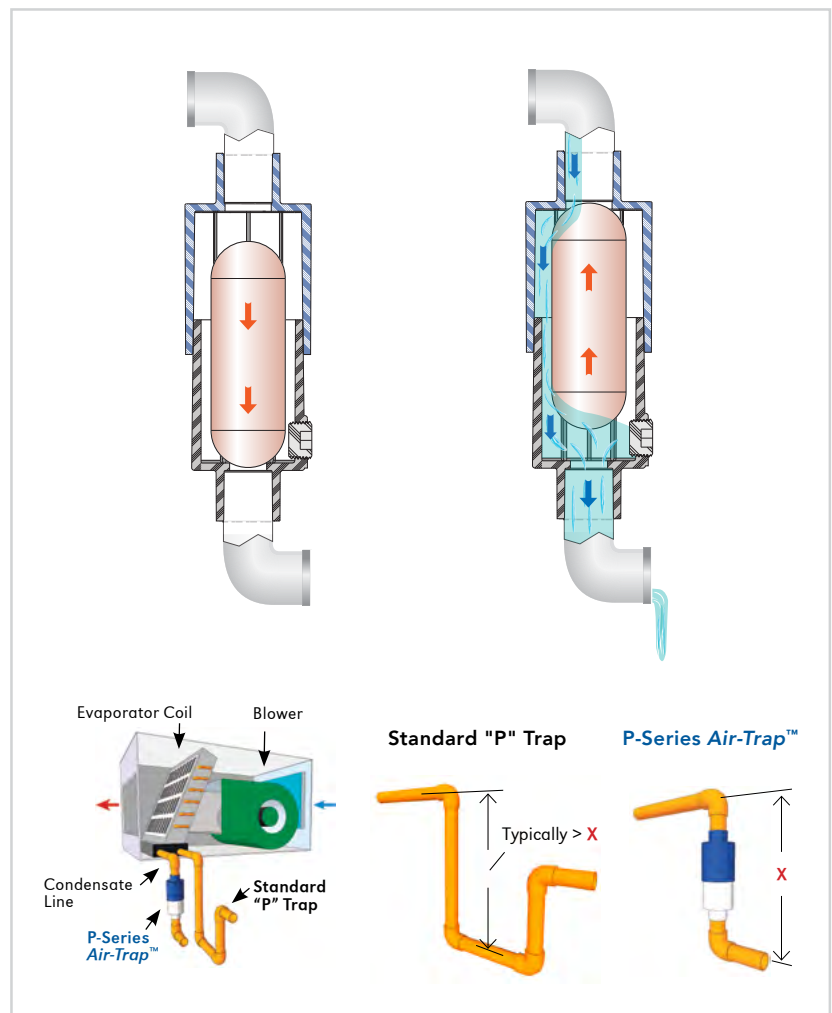
# P-Series HVAC Air-Trap™

## Positive Pressure Waterless Trap

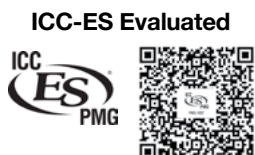
- P-Series Air-Trap requires no water head to cause the trap to operate. Simply come out of the plenum condensate line and go down into the P-Series Air-Trap. Come out of the trap and go horizontally with your drain line. The height requirement then becomes the height of the trap plus two elbows.
- When removing water, the water exits the unit but no air escapes the unit.
- Reduces sludge buildup that normally accumulates in standard "P" traps.
- Prevents problem with standard "P" trap never filling with water when condensate begins to form at the beginning of the cooling season.
- Prevents freezing of trap during cold periods since there is no water in the trap.



Patented



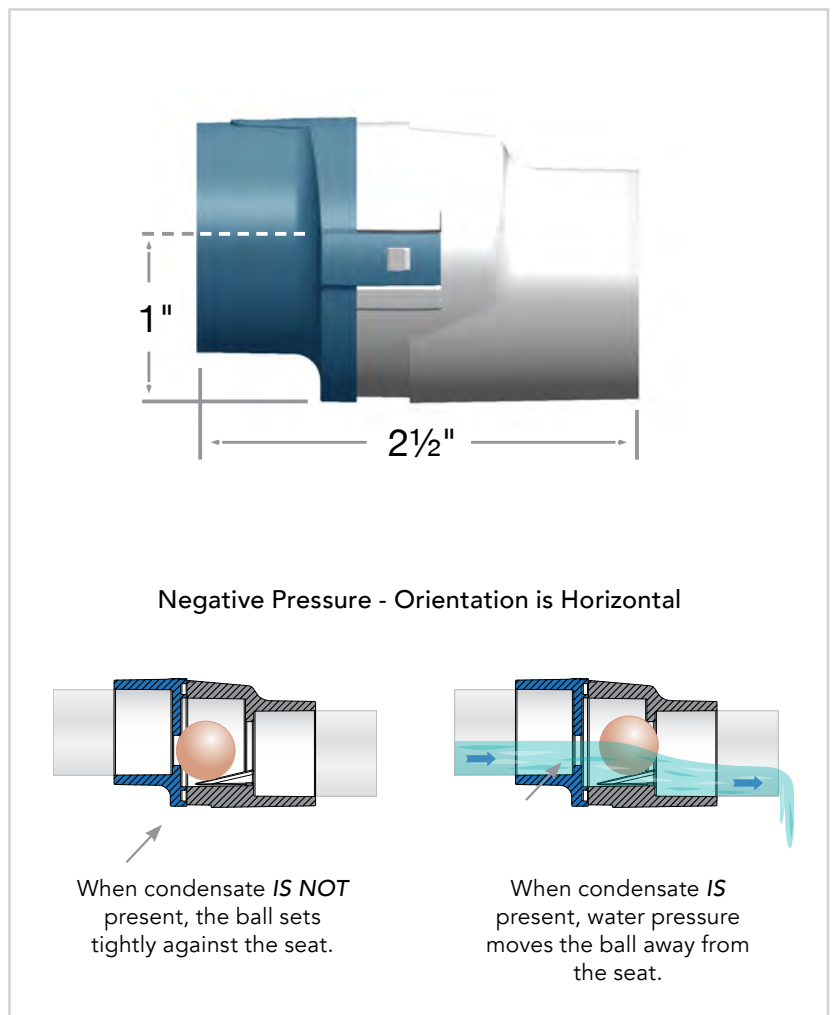
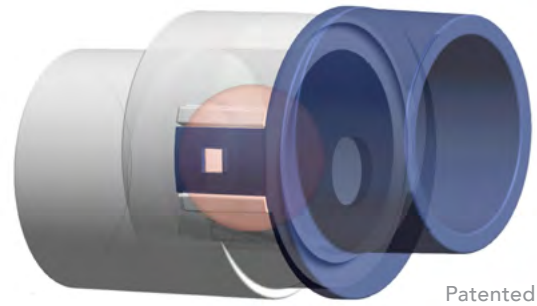
**IAPMO STANDARDS**  
The Air-Trap™ concept has been incorporated into IAPMO IGC 196-2018 Standard for Condensate Traps and Overflow Switches for Air-Conditioning Systems.



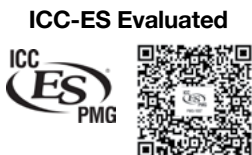
# FCN-Series HVAC Air-Trap™

## Negative Pressure Waterless Trap

- Condensate flow up to 1 GPM at 2" negative pressure
- Schedule 40 PVC with easy maintenance, side clips to open the Air-Trap for cleaning
- Retains no water after condensing has ceased
- ¾" internal slip or fitting (can connect to 1/2" via reducer coupling)
- Meets general building codes. For use on HVAC equipment only. Not for use as a sanitary trap.
- Maximum Negative Pressure of WC: 5"
- Maximum Positive Pressure of WC: ½"



The Air-Trap™ concept has been incorporated into IAPMO IGC 196-2018 Standard for Condensate Traps and Overflow Switches for Air-Conditioning Systems.



## PHP-Series HVAC Air-Trap™

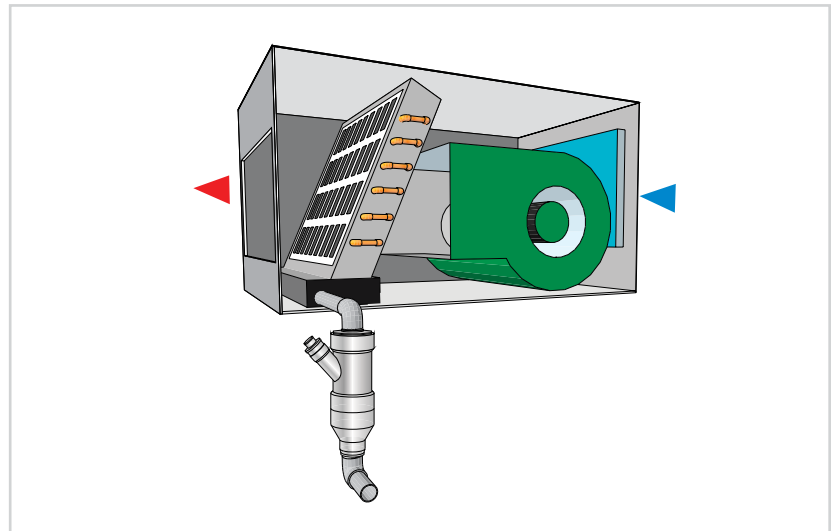
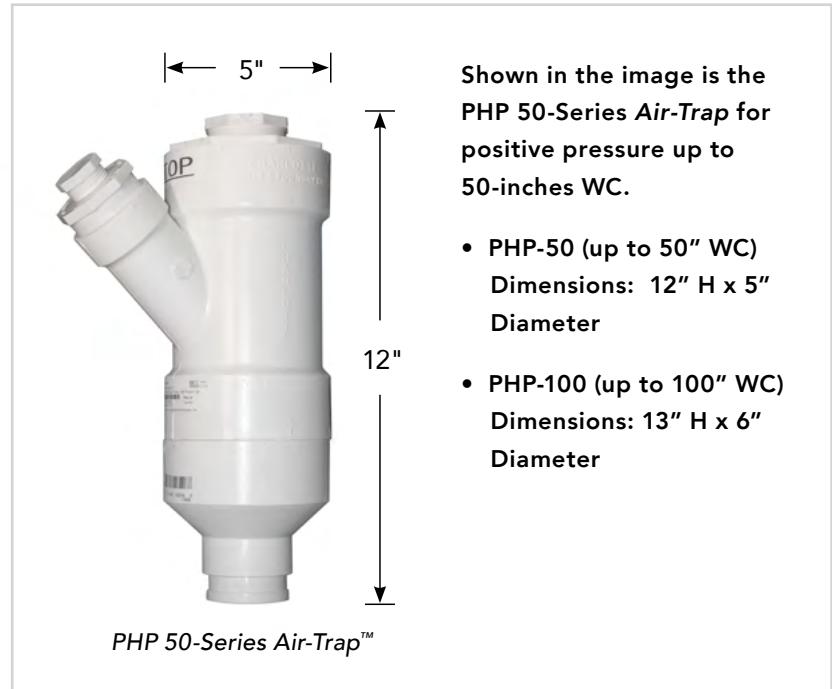
For Positive Pressures above 12-inches WC and up to 100-inches WC

Many commercial and industrial applications require delivered air to be prefiltered, cooled, heated, final filtered, and delivered through a complex ducting system at a low sound level. The stringent requirements result in a high positive pressure within the cooling coil compartment of the AC equipment. The condensate produced by the cooling coil must be removed without allowing conditioned air to escape to ambient.

At high pressures, a large amount of conditioned air can escape from the unit if it is not properly trapped. Typically, a P-Trap would be used to prevent this leakage. However, several factors would cause the standard P-Trap arrangement to be problematic at best.

The PHP-Series Air-Trap accomplishes the following:

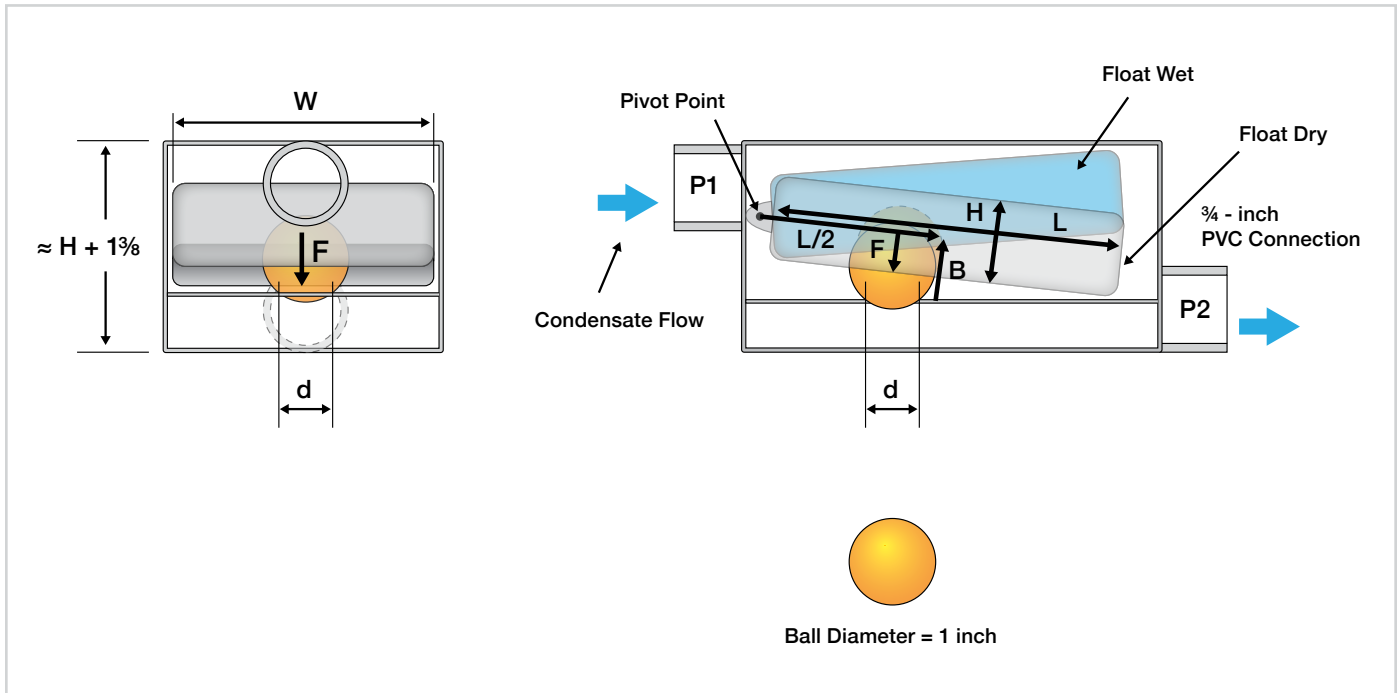
- The Air-Trap will never freeze and break
- Eliminates sludge build-up at bottom of "U" tube
- No more blow-through with positive pressure
- Requires no water head to cause the trap to operate. Simply come out of the plenum with the condensate line and go down into the PHP-Series Air-Trap. Come out of the trap and go horizontally with your drain line. The height,  $x$ , requirement then becomes the height of the trap plus two street elbows.
- And most important, the trap height is less than 13-inches tall, eliminating the need for mounting the AC equipment on rails, very high curbs, cutting holes in roofs, etc.





# PLP-Series HVAC Air-Trap™

## Low Height Positive Pressure Trap - Up to 100 inches of WC Positive Pressure

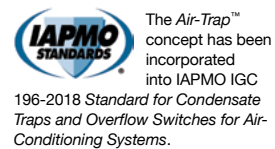


- P1 = 75.0 inches wc = 2.710 psi
- P2 = 0.00 inches wc = 0.000 psi (enter negative number if negative pressure)
- d = 0.63 inches
- H = 1.50 inches
- W = 3.00 inches
- L = 4.00 inches

Volume, in<sup>3</sup> = H x W x L = 18.00  
 Buoyancy, B = 0.65 lbs  
 Force Downward, F = (seat diameter/2)<sup>2</sup> x 3.1416 x (P1 - P2) = 0.8312807 lbs

Torque on float about pivot point  
 Buoyant torque = (1/2 x L + .25) x buoyancy  
 Pressure torque = 0.831280706 x (1/3 x L + 0.25)  
 Net torque = 0.147413924 inch pounds  
 Force on ball = 0.093182 **UPWARD FORCE GO**

Requires cleanability or ease of access to internal parts.



*The PLP is currently under development and is planned for March 2020 availability (patent pending).*

## HVAC Air-Trap™ FCN-Series NEGATIVE PRESSURE

This is a guide to the user of an FCN Series Air-Trap during installation, commissioning, operation, or periodic maintenance.

### The Benefits of the FCN Air-Trap are:

- Eliminates the geyser effect that is caused when the standard P-trap dries out and condensate begins to form
- Requires less than half the height of a p-trap
- Operates dry except when condensate is being produced
- Will not freeze
- No sludge build-up in bottom of trap
- Easily comes apart for cleaning

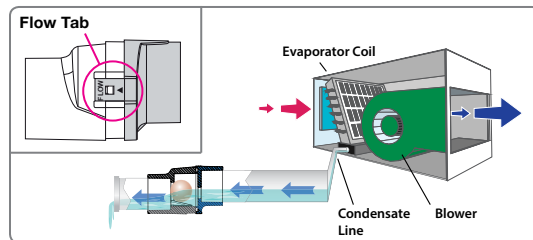


### Negative-Pressure Application

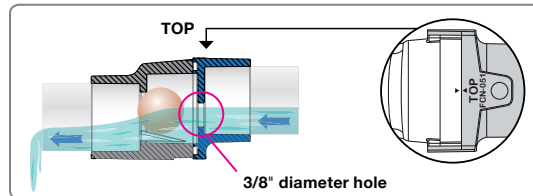
When operating with a negative pressure plenum, install the FCN Air-Trap in a horizontal orientation with the "FLOW" arrowhead pointing in the direction of water flow as shown in **Figure 1**. The direction of condensate flow is indicated on the larger of the two tabs that clamp together the two parts of the trap.

Condensate enters the end of the trap with the 3/8" diameter hole and the word "TOP" is molded into the inlet end of the FCN as shown in **Figure 2**.

**Figure 1**



**Figure 2**



When disassembling the FCN for maintenance, use a small flat head screwdriver and lightly, and slowly, pry the wider tab outward a few thousandth of an inch until the two parts separate. There should be no maintenance required other than cleaning. Reassembling requires that the O-ring be properly placed in the groove and the ball-valve be properly positioned as shown in **Figure 3**.

**DO NOT use too much cement**  
Too much cement may cause trap to fail.

- Standard connection is 3/4" slip. A 3/4" to 1/2" bushing can be used to accommodate a 1/2"- size PVC SCH 40 pipe.
- NEVER CONNECT CONDENSATE DRAIN DIRECTLY TO A SANITARY DRAIN LINE.

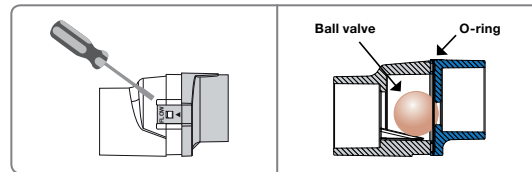
FCN IOM 0919



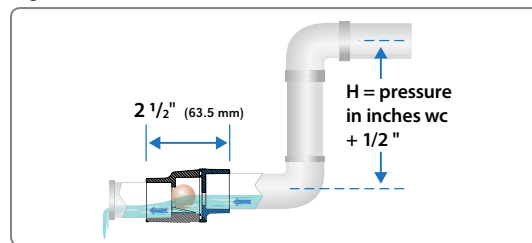
2 Nikki Lane  
Natural Bridge Station, VA 24579  
Phone: 540.228.1967  
info@deschampstechnologies.com  
www.deschampstechnologies.com

This product design is patented by Des Champs Technologies,™ LLC

**Figure 3**



**Figure 4**

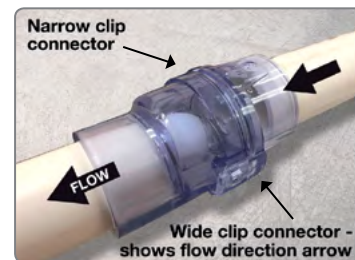


**Figure 4.** Installation of the FCN for negative pressure showing arrowhead pointing in direction of water flow.

FCN traps are rated at up to 1 GPM of condensate flow at essentially any negative pressure, but H (refer to Fig. 4) increases linearly with pressure.

**Figure 5. FCN with integral 3/4" slip connections**

There are two clips that connect the two parts of the trap, one clip is wider than the other, so make sure to match wide to wide and narrow to narrow.



# HVAC Air-Trap™ Testimonials

**Keith Dunnavant, V.P. Sales, Data Center Cooling Division**

*"We use Des Champs HVAC Air-Traps extensively on our data center cooling units so that our customers never have to prime them"*

**Todd D., President**

*"Since our first order, we have sent out a trap kit to resolve any complaint/concern about condensate lines overflowing/backing up or dehumidifiers leaking. The results have been perfect. Every complaint resolved. So, we do expect to be ordering more Air-Traps in the future."*

**Andre H @ Epic Servers**

*"This product is the next generation of traps for HVAC application. The esthetics of this trap is none to compare."*

**Ray A., V.P. Service Dept.**

*"We are very impressed with the results and relief this device offered this summer . . . very user friendly if service is needed but so far, this little device has solved the problem!"*

*We will definitely be using these in the future when the occasion arises. Thank you both for the excellent product and customer service . . . Top notch!"*

**Scott D., Sr. Product Development Engineer**

*"The testing of the waterless trap went well. There is a potential for this type of product in industry, especially from the service side of the business."*

**Michael J., Specifying Engineer**

*"Another reason why your solution is pretty awesome, it takes the guess work and likely long term failure scenarios out from poor planning and execution. Add to that something that is infinitely serviceable without having to cut out poorly plumbed pipe and you've got a win win for everyone involved."*



**RLC-Series**



**P-Series**



**FCN-Series**



The Air-Trap™ concept has been incorporated into IAPMO IGC 196-2018 Standard for Condensate Traps and Overflow Switches for Air-Conditioning Systems.



For more information and purchase options please visit  
[waterless-trap.com](http://waterless-trap.com) or  
[deschampstechnologies.com](http://deschampstechnologies.com)

2 Nikki Lane  
Natural Bridge Station, VA 24579  
Phone: 540.228.1967  
[info@deschampstechnologies.com](mailto:info@deschampstechnologies.com)