

Jonite

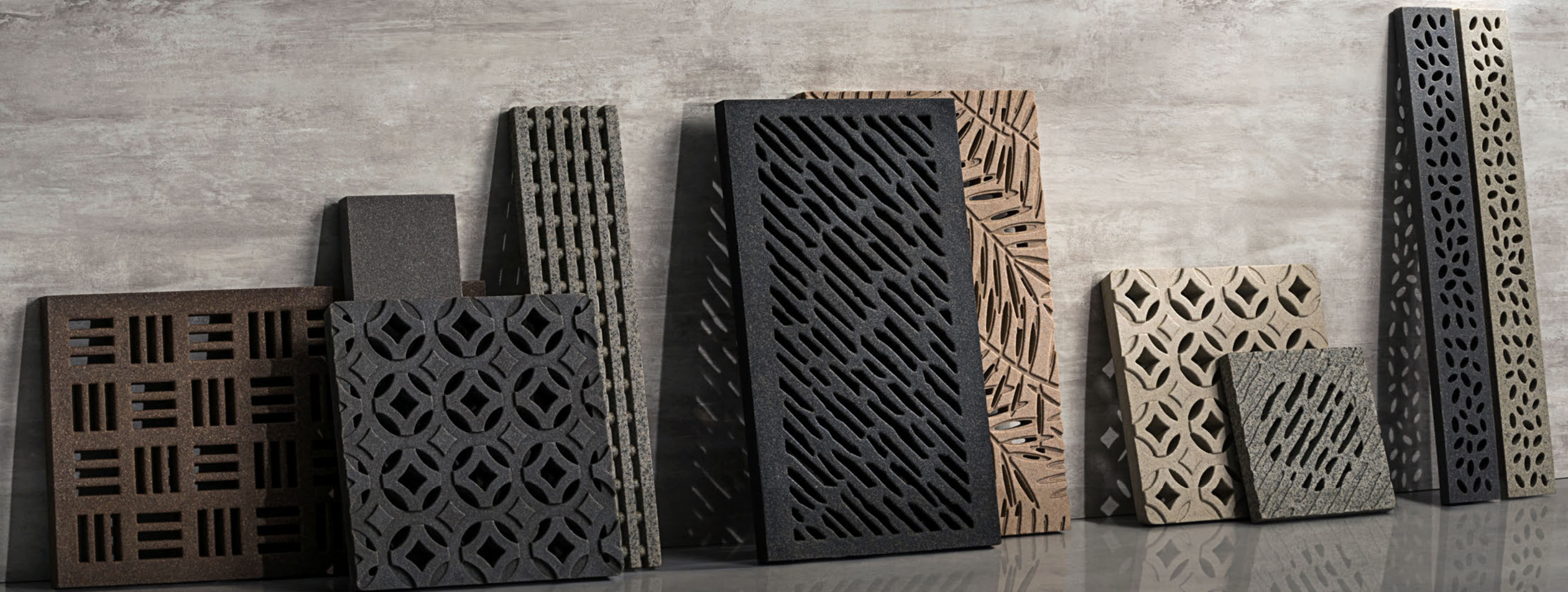

**PRODUCT
CATALOGUE**

Website
www.jonite.com

Social Media
f facebook.com/jonitestone
p pinterest.com/jonitestone
in linkedin.com/company/jonitestone
i instagram.com/jonitestone

Email
info@jonite.com

Phone
US +1-484-224-2972
Singapore +65-6383-3788

Table of Contents



01	
INTRODUCTION	4
Our Story	5
Why Jonite?	6
Sustainability	7
02	
CUSTOMISATION	8
Process	9
Customisable Area	11
Colours & Texture	12

03	
PRODUCTS	17
Trench Grates	18
Tree Grates	42
Pool Grates	60
Sump Covers	70
Bathroom Grates	82
Floor Drains	90
Ventilation Grilles	98
Breeze Blocks	102
Street Benches	108

04	
MAINTENANCE	116

05	
LOADING SPECIFICATIONS	117

06	
INSTALLATION GUIDES	118

Trench Grates	120
Curve Grates	126
Grate Tiles	130
Tree Grates	132
Banco™	136
Pool Grates	146
Sump Covers	149





Our Story

The spark behind our company and innovative products, historical innovation, and how Jonite's journey has resulted in being a partner of choice for hardscape solutions.

Inspired by the beautiful and magnificent stone castles built during the Middle Ages, we wondered if we could incorporate the rustic appeal of natural stone into durable, functional grates.

Thus began our journey to creating the world's first reinforced stone grate. After seven years of extensive research and development, we have coupled with intensive industry feedback, culminated in our first commercially-viable reinforced stone gratings launched to the world in 1994. In the years since then, we have continued to partner with architects, developers, and other distinguished customers in hardscape design.

We are striving to create even more durable, more aesthetically appealing, and environmentally friendly reinforced stone grates and panels. Thousands of clients have specified Jonite, chosen for the ultimate marriage of aesthetics and load-bearing performance.

Our Vision

Your reinforced decorative stone partner, presenting possibilities helping you solve architectural problems with innovative hardscape solutions.

We are your partner in presenting possibilities in helping you solve architectural problems with innovative reinforced stone solutions.

We are your stone hardscape partner that recognizes the transformational potential of a space. Our eye for detail, engaging designs, and dedication to lasting value aid architects to realise their vision. Every day, innovative development efforts are invested following constant feedback to ensure the best possible architectural products are created, with environmental concerns in mind, beauty, naturalness, and strength.

Our vision is to be a preferred brand that inspires architects to create bold and beautiful designs using our stone solutions.

Why Jonite?



Stone Aesthetics

Created from 95% natural aggregates and advanced hybrid polymers, Jonite architectural grates provide a finish which is both luxurious and natural to the touch, enabling architects to create unified designs from grates to street furniture and more.



Slip Resistance

Rough and natural matte surface enables natural slip resistance held up to international classifications. This provides a much-needed and unparalleled safety feature for schools and hospitals.



Sustainability

All Jonite products comprise at least 30% recycled materials, and our R&D team is constantly working to make our products and manufacturing processes even more sustainable. We are also held up to several sustainability standards in Singapore and the US.



Durability

The unique material properties of Jonite products which prevents rust and corrosion mean they are equally suited to last a lifetime for both indoor and outdoor applications.



Theft Resistant

Conventional steel and cast iron grates and castings are highly susceptible to theft due to rising scrap value worldwide. Jonite hardscape products however, do not pose any value for scrap due to their stone material integrity.



High Performance Properties

Reinforced with specially treated steel frames, Jonite grates provide stunning load bearing performance and are compliant to international load standards. Jonite stone products have high flexural, compressive and impact strength, low water and heat absorption.

Jonite, Your Green Partner

Jonite's commitment to the environment is driven from within its core values of the company's vision and mission. Our primary aim is to ensure longevity and quality of our products through energy-saving and resource-conserving production.

Our green practices are recognized – Green Label certified under Singapore Environment Council. The Building and Construction Authority (BCA) of Singapore Green Mark recognizes the use of Green Label certified products, and awards Green Mark points for their usage.

Jonite is also the only grates manufacturer to be recognized as a Leader with 4 ticks under the SGBC (Singapore Green Building Council) Architectural Drain Covers category. Products are assessed on their environmental properties and performance through a comprehensive list of assessment criteria covering the five key areas of Energy Efficiency, Water Efficiency, Resource Efficiency, Health & Environmental Protection and Other Green Features. This enables architects to accrue more BCA Green Mark points if they choose to use our reinforced stone trench grates.

Through the LEED® (Leadership in Energy and Environmental Design) green building certification programme, the U.S. Green Building Council is transforming the built environment. As a member of the USGBC and with the usage of recycled content, Jonite satisfies MR Credit 4: Recycled Content under LEED®. The LEED® Green Building Rating System is the nationally accepted benchmark for the design, construction and operation of high performance green building in the United States.



Custom Design Solutions

Jonite's Design Department comprises of a team of creative designers and experienced engineers working in close collaboration with our Research and Development team. With our integrated operations, we bring you a one-stop support service that assists architects all the way from design concept to the final physical product.

- Custom applications
- Tailored load requirements
- Unique patterns and aesthetics
- Colours that match your project
- A plethora of size options



The Customisation Process

01 Collaboration

The design team will have an in-depth discussion with you about your goals and vision as to how Jonite panels can fit into your overall design plans. During this time, we will also ensure that there is both material feasibility and cost efficiency before moving forward.

02 Conceptualisation

Upon receiving details in terms of the design or application effect you'd like to achieve, the design team will work to conceptualise the ideas. Depending on the time you have set aside for customisation, the team may suggest modifications on our current existing line of products, or create a brand new design.

03 Design & Testing

Our designers will create designs and run stress tests if necessary. During this stage, renderings will be made so that you would be able to visualise the concept fully. Upon receiving your feedback, adjustments can be made to make sure that our designs perfectly encapsulate your vision.

04 Approval

Once all of the requirements are satisfied, we will seek final sign off before commencing production. At this point in time, we can fully support with any shop drawings required to make sure that all details are captured for the successful completion of your project.

05 Production

Upon securing the necessary approvals, we will commence with production. Here at Jonite, we practice Just-In-Time production for all of our products, and are fully capable of making sure we can deliver within the lead time specified. Our experienced sales consultants can help assist to make sure that delivery is on-time for the project.



Customisable Areas

Our design team is dedicated to working hand-in-hand with architects and designers to overcome the constraints of different materials so as to achieve the designs of your visions.



Applications

We have helped architects create street furniture, ventilation grilles that also serve as a walking platform, decorative shopfront wall panels and more.



Load Specifications

Our design team can help suggest ways to reinforce our already-strong grates during the manufacturing process.



Open Area

You can customise the open areas for our reinforced stone grates so as to fit the design demands for gratings like ventilation grilles.



Colours & Textures

Our unique composite stone material enables you to choose any hue or texture to perfectly express your creativity.

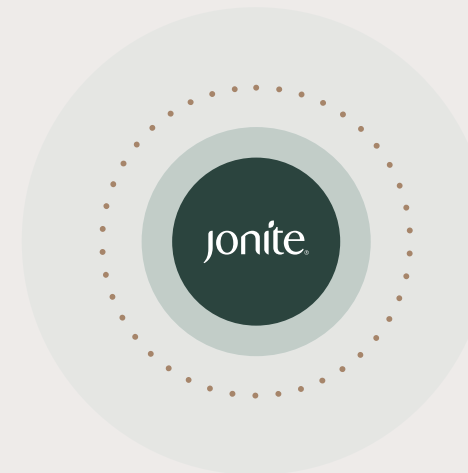

Patterns

Be it sleek elegance, or playful modernity, you can achieve the perfect look by choosing to customise the patterns of any of our products.



Sizes

Have a unique design vision which calls for curved drainage covers or odd shapes or sizes? You can customise any Jonite design to specific dimensions to cut down on construction inefficiencies.

Colours & Textures

On top of functional features, our team puts special efforts to create the products that work along with your design naturally and aesthetically. We offer a vast range of customised colours for our products, in addition to beautifully curated 16 standard colours by us.

Customised Colours

Step 1



Your sample, a reference for us to match, is couriered to Jonite's colour matching facility. Assessed by our specialists, material and colour combinations are calculated so to achieve the closest possible match. A process that can be achieved within two weeks.

Step 2

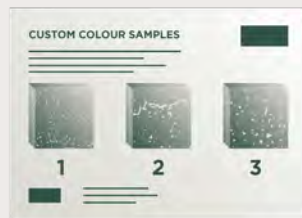

Upon completion of the colour matching process, our facility will supply you with three physical samples, different shades of the reference samples for your approval. You will have tangible colour & texture samples of the final product prior to production.

Step 3

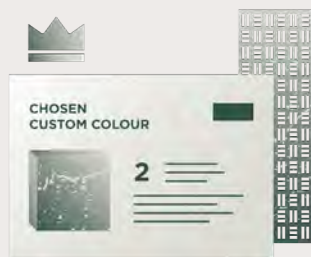

Once the desired shade is selected, production will commence on your products and the unique formula saved for future reference. Through our patented technologies, our products can achieve up to a 90% match (to your reference sample).

Standard Colours

*Please note that the samples inherit their core colours from their natural sources, colour may vary slightly from the images shown.

IVORY WHITE



WACKY WHITE

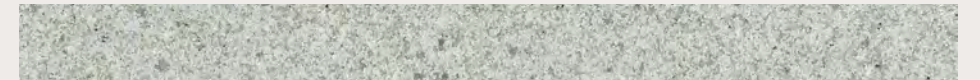

ROSY BEIGE



DESERT BEIGE



CHAMPAGNE YELLOW



TERRACOTTA RED



TEAK BROWN



MOCCA BROWN

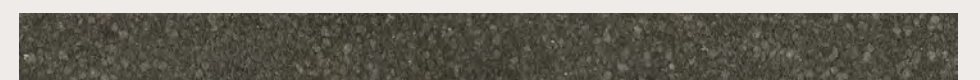

GRANITE GREY



ASH GREY



STEEL GREY



SLATE GREY



BAMBOO GREEN



SMOKY GREEN



CHARCOAL BLACK



EBONY BLACK



03
PRODUCTS

Trench Grates	20
Tree Grates	44
Pool Grates	62
Sump Covers	72
Bathroom Grates	84
Floor Drains	92
Ventilation Grilles	100
Breeze Blocks	104
Street Benches	110



TREE GRATES
Incorporate nature's elements into any modern city and hardscape, in harmony with nature.



BATHROOM GRATES
The world's first reinforced stone bathroom grates are beautifully crafted for both indoors and outdoors.

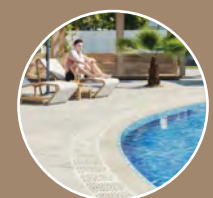

POOL GRATES
With its natural beauty and suitability superior to natural granite, make for the perfect pool grating.

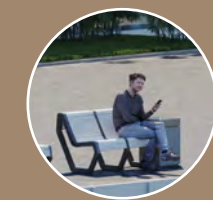

STREET BENCHES
Jonite's versatile panels make the perfect site furnishing, such as street benches.



VENTILATION GRILLES & BREEZE BLOCKS
One of our newest lines of products, the ventilation grate and breeze blocks are a natural extension of our existing reinforced stone hardscape products.



FLOOR DRAINS
Jonite's homogenous stone floor drains can match any tile to form a trap cover, achieving desired coherence with functional designs.



SUMP COVERS
Add the natural modern stone aesthetic to your designs for point drainage systems.



TRENCH GRATES
Natural reinforced stone trench grates, a modern finish that complements any city's hardscape.





03
PRODUCTS



TRENCH GRATES

General Information	20
Slotted	22
High Performance	28
Ready-Cut	32
Pattern	34
Avant-Garde	36
Nature	38
Modern	40

Trench Grates

Optional Features and Accessories

Jonite reinforced stone trench grates add a gloss of natural, yet modern finish that complements any city hardscape. The humble drain can now be elevated to match any design style.



Heel-Guard™ Grates

Heel-Guard™ Grates have slim 6mm slots and small radius fillets to prevent high heels from being caught in the grates. Compliant with Americans with Disabilities Act (ADA) requirements, these are extremely useful for cut-off or scupper drains of the entrance or concourse areas of a building.

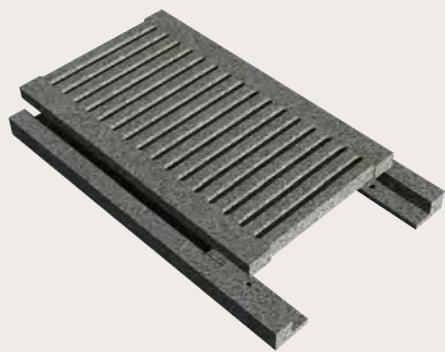

Grate Tiles™

Grate Tiles™ are standard non-perforated solid slabs that have the same material composition and colour as Jonite grates. They are mainly used when a drain encounters an irregular joint or to fill an odd end of a drain.

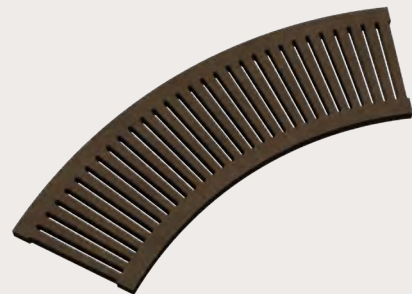

L-Trimmers™

L-Trimmers™ is recommended for gratings built for heavy-duty applications and above. They are designed to provide aesthetic flair as well as the ideal support for all Jonite grates.

Custom Curve Grates

Curve grates are available in any radius and design upon request. All radius in a plan will be consolidated in a full-scale CAD drawing to help minimize the number of custom toolings required.

GENERAL SPECIFICATIONS

A fundamental hardscape design element of any modern city is the drainage system, which protects against flooding by draining excess water away.

Now, underground drainage systems are designed to cope with frequent storms where any excess water always travels along the planned drainage flow paths to prevent flooding. Drainage systems are carefully planned to factor in the impact the drainage system has on our natural rivers and creeks. We are preventing waste from being washed into rivers and seas.

At Jonite, our reinforced stone channel grates and trench grates have redefined the role of gratings and drain covers in the architecture industry. With Jonite channel gratings and trench gratings, outdoor drain covers are more than functional products – they become a cornerstone in your design. They can become design focal points, inviting the viewer's eye to follow intricate patterns that open up into the building design.

All products in Jonite trench grates collection are available in exquisite textures and colours. All its trench grates give you the finish of natural stone with the strength to sustain pedestrian and vehicular load performance and durability for a lifetime.

Jonite absorbs much less heat compared to traditional ferrous gratings, making it a more comfortable material to have around the house and in children's playgrounds. Also, it has dielectric properties equivalent to porcelain, making it an excellent electrical insulator- a significant plus point in times of tropical thunderstorms.

Landscape architects like yourself have used our channel and trench grates for a variety of purposes, such as outdoor drain covers, channel grating along driveways, storm drainage and indoor applications. Aesthetics and functionality in a perfect marriage culminating in Jonite products makes us the natural choice.

PRODUCT SPECIFICATIONS



Slip resistant

Rust & corrosion resistant

BS EN 124:2015 & 1433:2008 compliant

Dielectric properties with excellent electric insulator

Less heat absorbent than traditional ferrous grates

LEED® (Leadership in Energy and Environmental Design) green building certified

LOADING SPECIFICATIONS



Class A15 - Class D400



COLLECTION
SLOTTED

Classic and clean-cut designs in compliance with BS EN 124:2015 that cover a wide range of openings. Suitable for various applications, from scupper indoor and outdoor drains to common house drains and wider drains in parks, commercial and industrial surroundings.



31110 **S1-125H25LD**
Load class A15
Drain width 75 to 90mm
Dimension 125W x 500L x 25mm (t)

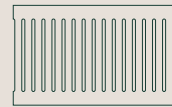

31114 **C2-292H25LD**
Load class A15
Drain width 210 to 242mm
Dimension 292W x 500L x 25mm (t)



31111 **S1-125H25HD**
Load class B125
Drain width 75 to 85mm
Dimension 125W x 500L x 25mm (t)

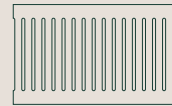

31115 **C2-292H35HD**
Load class B125
Drain width 210 to 232mm
Dimension 292W x 500L x 35mm (t)



31112 **C1-210H25LD**
Load class A15
Drain width 128 to 170mm
Dimension 210W x 500L x 25mm (t)

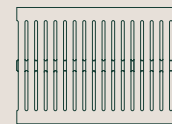

31116 **C3-355H25LD**
Load class A15
Drain width 273 to 305mm
Dimension 355W x 500L x 25mm (t)



31113 **C1-210H35HD**
Load class B125
Drain width 128 to 160mm
Dimension 210W x 500L x 35mm (t)

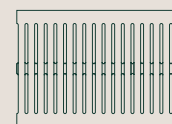

31117 **C3-355H35HD**
Load class B125
Drain width 273 to 295mm
Dimension 355W x 500L x 35mm (t)

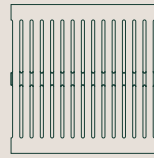

31118 **C4-435H35LD**
 Load class A15
 Drain width 345 to 385mm
 Dimension 435W x 420L x 35mm (t)

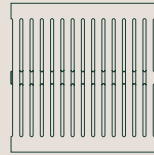

31119 **C4-435H50HD**
 Load class B125
 Drain width 345 to 375mm
 Dimension 435W x 420L x 50mm (t)

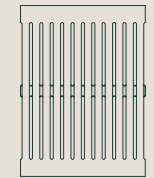

31120 **C5-500H35LD**
 Load class A15
 Drain width 400 to 450mm
 Dimension 500W x 365L x 35mm (t)

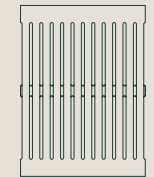

31121 **C5-500H50HD**
 Load class B125
 Drain width 400 to 440mm
 Dimension 500W x 365L x 50mm (t)



34119C **90° S1-H25LD**
 Load class A15
 Suitable for Standard S1-125H25LD



34120C **90° S1-H25HD**
 Load class B125
 Suitable for Standard S1-125H25HD

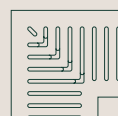

34110C **90° C1-H25LD**
 Load class A15
 Suitable for Standard C1-210H25LD

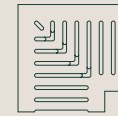

34111C **90° C1-H35HD**
 Load class B125
 Suitable for Standard C1-210H35HD

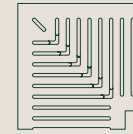

34113C **90° C2-H25LD**
 Load class A15
 Suitable for Standard C2-292H25LD

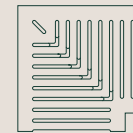

34114C **90° C2-H35HD**
 Load class B125
 Suitable for Standard C2-292H35HD

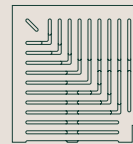

34116C **90° C3-H25LD**
 Load class A15
 Suitable for Standard C3-355H25LD

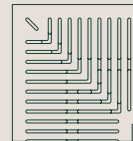

34117C **90° C3-H35HD**
 Load class B125
 Suitable for Standard C3-355H35HD

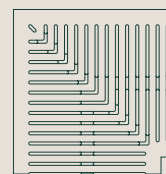

34133C **90° C4-H35LD**
 Load class A15
 Suitable for Standard C4-435H35LD

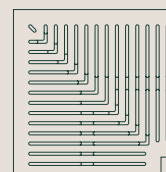

34134C **90° C4-H50HD**
 Load class B125
 Suitable for Standard C4-435H50HD

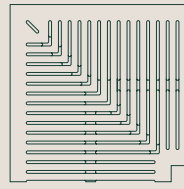

34135C **90° C5-H35LD**
Load class A15
Suitable for Standard C5-500H35LD

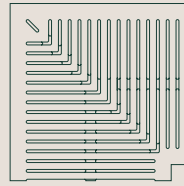

34136C **90° C5-H50HD**
Load class B125
Suitable for Standard C5-500H50HD

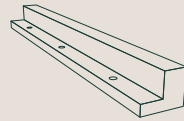

34121C **L-TRIMMER-25LD**
Dimension 60W x 500L x 35mm (t)

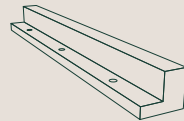

34122C **L-TRIMMER-35HD/EHD**
Dimension 60W x 500L x 50mm (t)

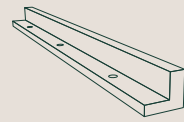

34126C **L-SLIM-TRIMMER-25LD/HD**
Dimension 40W x 500L x 35mm (t)

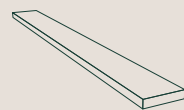

34127C **TS-50-LD (Tile-Strip)**
Dimension 50W x 500L x 10mm (t)

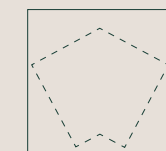

34129C **GT-400H25LD (Grate-Tile)**
Load class A15
Dimension 400W x 400L x 25mm (t)

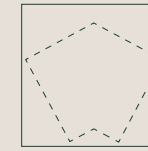

34131C **GT-400H35HD (Grate-Tile)**
Load class B125
Dimension 400W x 400L x 35mm (t)

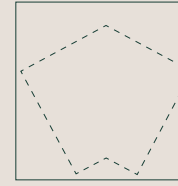

34130C **GT-500H25LD (Grate-Tile)**
Load class A15
Dimension 500W x 500L x 25mm (t)

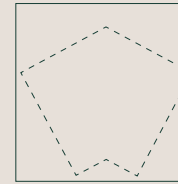

34132C **GT-500H35HD (Grate-Tile)**
Load class B125
Dimension 500W x 500L x 35mm (t)

COLLECTION
**HIGH
PERFORMANCE**

Specially designed for heavy loading applications such as car-park entrances, hard-standing areas, driveways and kerb sides. L-Trimmers are recommended to ensure a flat and level seating of gratings.



32110 **C1-210H35EHD**
Load class C250
Drain width 128 to 150mm
Dimension 210W x 500L x 35mm (t)



32111 **C1-210H50CHD**
Load class D400
Drain width 128 to 150mm
Dimension 210W x 500L x 50mm (t)

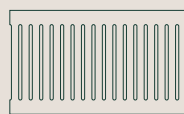

32112 **C2-292H35EHD**
Load class C250
Drain width 210 to 230mm
Dimension 292W x 500L x 35mm (t)

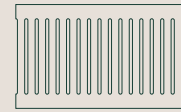

32113 **C2-292H50CHD**
Load class D400
Drain width 210 to 230mm
Dimension 292W x 500L x 50mm (t)

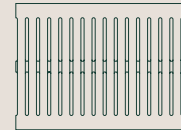

32114 **C3-355H50EHD**
Load class C250
Drain width 273 to 285mm
Dimension 355W x 500L x 50mm (t)

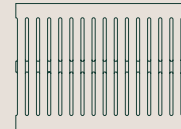

32115 **C3-355H75CHD**
Load class D400
Drain width 273 to 285mm
Dimension 355W x 500L x 75mm (t)

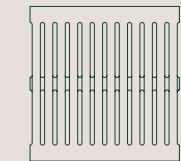

32116 **C4-435H70EHD**
Load class C250
Drain width 345 to 365mm
Dimension 435W x 420L x 70mm (t)

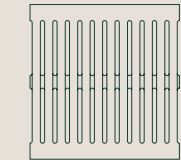

32125 **C4-435H75CHD**
Load class D400
Drain width 345 to 365mm
Dimension 435W x 420L x 75mm (t)



32117 **D1-167H35EHD**
Load class C250
Drain width 100 to 117mm
Dimension 167W x 750L x 35mm (t)



32118 **D1-167H50CHD**
Load class D400
Drain width 100 to 117mm
Dimension 167W x 750L x 50mm (t)

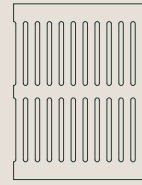

32121 **D3-495H75EHD**
Load class C250
Drain width 395 to 425mm
Dimension 495W x 370L x 75mm (t)

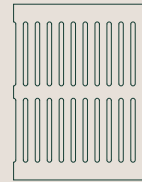

32122 **D3-495H75CHD**
Load class D400
Drain width 395 to 425mm
Dimension 495W x 370L x 75mm (t)



32123 **BW1-260H50EHD**
Load class C250
Drain width 200mm
Dimension 260W x 500L x 50mm (t)



32124 **BW2-400H50EHD**
Load class C250
Drain width 330mm
Dimension 400W x 500L x 50mm (t)



34112C **90° C1-H35EHD**
Load class C250
Suitable for Standard C1-210H35EHD



34115C **90° C2-H35EHD**
Load class C250
Suitable for Standard C2-292H35EHD

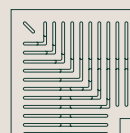

34118C **90° C3-H50EHD**
Load class C250
Suitable for Standard C3-355H50EHD

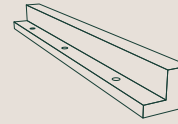

34122C **L-TRIMMER-35HD/EHD**
Dimension 60W x 500L x 50mm (t)

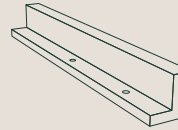

34123C **L-TRIMMER-50EHD/CHD**
Dimension 65W x 500L x 65mm (t)

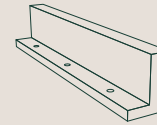

34124C **L-TRIMMER-70EHD/CHD**
Dimension 65W x 420L x 85mm (t)

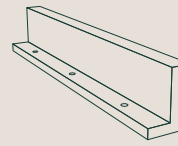

34125C **L-TRIMMER-75EHD/CHD**
Dimension 65W x 500L x 90mm (t)

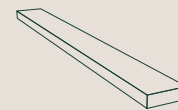

34128C **TS-50-HD/EHD (Tile-Strip)**
Dimension 50W x 500L x 15mm (t)

COLLECTION
READY-CUT

Designed for replacement purposes without any form of construction work on existing drains. The longitudinal side of the gratings has a wider edging so that they can be cut to attain the required widths.

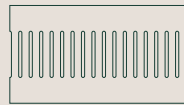

33110 **CC1-275H25LD**
Load class A15
Drain width 171 to 225mm
Dimension 275W x 500L x 25mm (t)

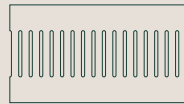

33111 **CC1-275H35HD**
Load class B125
Drain width 161 to 215mm
Dimension 275W x 500L x 35mm (t)



33112 **CC1-275H35EHD**
Load class C250
Drain width 161 to 205mm
Dimension 275W x 500L x 35mm (t)

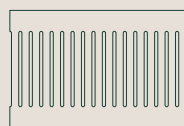

33113 **CC2-330H25LD**
Load class A15
Drain width 243 to 280mm
Dimension 330W x 500L x 25mm (t)

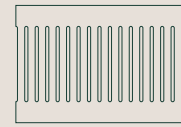

33114 **CC2-330H35HD**
Load class B125
Drain width 233 to 270mm
Dimension 330W x 500L x 35mm (t)

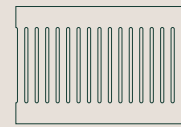

33115 **CC2-330H50EHD**
Load class C250
Drain width 223 to 260mm
Dimension 330W x 500L x 50mm (t)

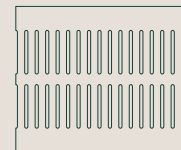

33116 **CC3-410H35LD**
Load class A15
Drain width 225 to 360mm
Dimension 410W x 500L x 35mm (t)

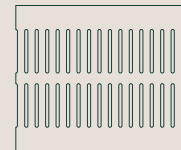

33117 **CC3-410H35HD**
Load class B125
Drain width 296 to 350mm
Dimension 410W x 500L x 35mm (t)

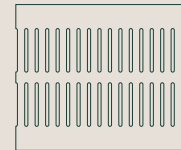

33118 **CC3-410H50EHD**
Load class C250
Drain width 286 to 340mm
Dimension 410W x 500L x 50mm (t)

COLLECTION
PATTERN

Creative and imaginative designs for enhanced aesthetic flair while maintaining load strength. Available in 2 standard designs: ornate Keyholes and contemporary Baby Pebbles.

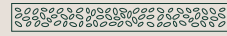

U33115 **MG-PEBBLES-78**
Load class 6KN
Drain width 52 to 54mm
Dimension 78W x 610L x 21/25mm (t)



61115 **BABY PEBBLES-86**
Load class 6KN
Drain width 56 to 62mm
Dimension 86W x 498L x 23mm (t)



61116 **BABY PEBBLES-122**
Load class 6KN
Drain width 80 to 100mm
Dimension 122W x 498L x 19mm (t)

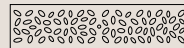

U32115 **TG-PEBBLES-124**
Load class 6KN
Drain width 92 to 100mm
Dimension 124W x 500L x 19mm (t)



61111 **BABY PEBBLES-150**
Load class 6KN
Drain width 100 to 125mm
Dimension 150W x 500L x 25mm (t)



61112 **BABY PEBBLES-210**
Load class 6KN
Drain width 160 to 170mm
Dimension 210W x 500L x 25mm (t)

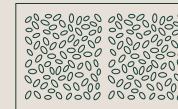

61113 **BABY PEBBLES-300**
Load class 6KN
Drain width 245 to 260mm
Dimension 300W x 500L x 35mm (t)



61117 **KEYHOLES-122**
Load class A15
Drain width 92 to 100mm
Dimension 122W x 498L x 22mm (t)



U32112 **TG-KEYHOLES-124**
Load class A15
Drain width 92 to 100mm
Dimension 124W x 500L x 22mm (t)



61118 **KEYHOLES-300**
Load class 6KN
Drain width 250mm
Dimension 300W x 500L x 28mm (t)



COLLECTION
AVANT-GARDE

Abstract and innovative designs reminiscent of rain motifs for a futuristic and non-traditional finish.



64115 **CHISELED-122**
Load class 6KN
Drain width 92 to 100mm
Dimension 122W x 498L x 22mm (t)

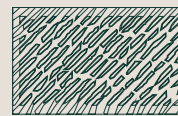

64116 **CHISELED-300**
Load class 6KN
Drain width 250mm
Dimension 300W x 500L x 28mm (t)



U32110 **TG-CHISELED-124**
Load class A15
Drain width 92 to 100mm
Dimension 124W x 500L x 22mm (t)

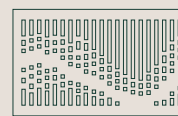

64114 **RAIN-SWING-300**
Load class A15
Drain width 250mm
Dimension 300W x 500L x 25mm (t)

COLLECTION
NATURE

Created with floral and leaf-inspired designs for a stylish tropical resort touch, that allows the gratings to blend in more aesthetically with different landscapes and architecture.



62111 **LEAVES-310**
Load class 5KN
Drain width 210 to 260mm
Dimension 310W x 335L x 25mm (t)



U32114 **TG-PALM-124**
Load class A15
Drain width 92 to 100mm
Dimension 124W x 500L x 22mm (t)



62112 **FOREST-300**
Load class 5KN
Drain width 250mm
Dimension 300W x 500L x 25mm (t)



62114 **PALM-300**
Load class 6KN
Drain width 250mm
Dimension 300W x 500L x 28mm (t)



62113 **PALM-122**
Load class A15
Drain width 92 to 100mm
Dimension 122W x 498L x 22mm (t)

COLLECTION
MODERN

Minimalist and clean architectural lines feature strongly in this collection, making it the best match for modern styles. Available in 3 types of designs: Cross-Stitch, Interlace, and Square Slots.



63115 **CROSS-STITCH-86**
Load class A15
Drain width 60mm
Dimension 86W x 498L x 23mm (t)



63116 **CROSS-STITCH-122**
Load class A15
Drain width 92 to 100mm
Dimension 122W x 498L x 19mm (t)



U32111 **TG-CROSS-STITCH-124**
Load class A15
Drain width 92 to 100mm
Dimension 124W x 500L x 19mm (t)

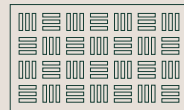

63110 **CROSS-STITCH-300**
Load class 6KN
Drain width 250mm
Dimension 300W x 500L x 25mm (t)



U33112 **MG-INTERLACE-78**
Load class A15
Drain width 52 to 54mm
Dimension 78W x 610L x 21/25mm (t)



63117 **INTERLACE-122**
Load class A15
Drain width 92 to 100mm
Dimension 122W x 498L x 22mm (t)



U32113 **TG-INTERLACE-124**
Load class A15
Drain width 92 to 100mm
Dimension 124W x 500L x 22mm (t)

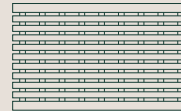

63118 **INTERLACE-300**
Load class 6KN
Drain width 250mm
Dimension 300W x 500L x 25mm (t)



63119 **SQUARE-SLOTS-122**
Load class A15
Drain width 80mm
Dimension 122W x 498L x 19mm (t)



U32116 **TG-SQUARE-SLOTS-124LD**
Load class A15
Drain width 80 to 100mm
Dimension 124W x 500L x 19mm (t)



U32117 **TG-SQUARE-SLOTS-124HD**
Load class B125
Drain width 72 to 82mm
Dimension 124W x 500L x 19/35mm (t)

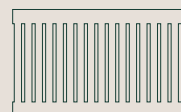

63120 **SQUARE-SLOTS-300**
Load class A15
Drain width 250mm
Dimension 300W x 500L x 25mm (t)



03
PRODUCTS



TREE GRATES

General Information	44
Firework	46
Concentric	48
Wheel	50
Star Grate	52
Pebble Hole	54
Large Tree Grate	56
Panel Grate	57
ADA	58

Tree Grates

Incorporate nature's elements into any modern city and hardscape, in harmony with nature. In our concrete jungles today, trees play an essential role not just aesthetically, but also to complement the modern-day drainage system. Complete the look with Jonite reinforced stone tree grates.



ADA compliant

Complied to the Americans with Disabilities Act (ADA), selected Jonite Tree Grates are certified ADA compliant. This makes our tree grates popular in hospitals, clinics and residential areas.

Embossed Insignia

With Jonite, you can easily emboss a corporate insignia or municipal logo right onto the tree grates in use in your environment, giving it an exclusive identity to the locale.

Night Illumination

Jonite Tree Grates allows fully customisable light ports or sockets for the installation of many different types and sizes of lights for night illumination this will add an exciting dimension to the natural beauty of trees.

Expandable Rings

Some of our tree grates allow for expandability of inner diameter to accommodate the exponential growth of tree trunks during the maturity stage.

GENERAL SPECIFICATIONS

Trees are essential in landscape planning. They are having positive effects such as reducing urban warming effects, providing shade to pedestrians, and adding a focal point to your driveway.

Tree grates are vital because they help avoid soil compaction and prevent tree roots from becoming obstacles to pedestrians, thus creating more walking space.

Our tree gratings are designed with the promotion of tree protection in mind, allowing rainwater to seep through while having narrow slits to prevent litter from falling through and smothering the soil. Some of our tree grates allow for expandability of inner diameter to accommodate the exponential growth of tree trunks during the maturity stage. Add inner rings when the trees are younger, and remove as the tree matures.

Some of the Jonite tree gratings are certified ADA compliant. Making our tree grates accessible in hospitals, clinics, and public areas as wheelchair users have no issues navigating their way around the grills.

Cast-iron tree grates may be prone to theft. Jonite reinforced stone tree grilles are theft-resistant because they do not pose any value for scrap due to their stone material integrity.

Jonite tree grates have low heat absorption properties to help create a conducive environment for the trees. Using cast-iron or metal can cause surrounding temperatures to soar, which might not promote ideal growth in trees.

Our tree grille designs allow for fully customizable light ports or sockets for the installation of many different types of lighting for night illumination.

We are adding an exciting dimension to the natural beauty of trees. Efficiently emboss a corporate insignia or municipal logo right onto the tree grates in your environment, giving an exclusive identity to the locale.

We also incorporate the use of at least 30% recycled content in our products, including our tree grates. This process is our commitment to contributing to a sustainable and green environment.

PRODUCT SPECIFICATIONS



ADA (Americans with Disabilities Act) compliant for selected models

Fully customizable light ports and logos

Suitable for any tree

Expandable inner diameter to allow for future tree growth

LOADING SPECIFICATIONS



5KN

Strictly for pedestrian application only



COLLECTION
FIREWORK

One of the most popular patterns available, this collection has broad profile openings with design patterns resembling enchanting bursts of fireworks. Optional reducers can also be used to adjust the inner diameter of the tree-wells.



81110 **FIREWORK S1000**
Inner Well 545mm Dia.
Dimension 1000W x 1000L x 30mm (t)



81111 **FIREWORK S1100**
Inner Well 600mm Dia.
Dimension 1100W x 1100L x 30mm (t)



81112 **FIREWORK S1200**
Inner Well 600mm Dia.
Dimension 1200W x 1200L x 30mm (t)

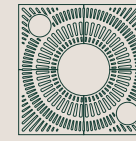

81113 **FIREWORK S1500/600 (w/ light ports)**
Inner Well 600mm Dia.
Dimension 1500W x 1500L x 30mm (t)

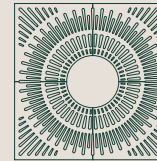

81117 **FIREWORK S1800/600**
Inner Well 600mm Dia.
Dimension 1800W x 1800L x 30mm (t)

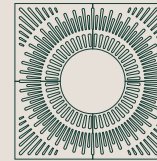

81118 **FIREWORK S1800/750**
Inner Well 750mm Dia.
Dimension 1800W x 1800L x 30mm (t)

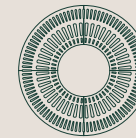

81115 **FIREWORK R1500**
Inner Well 600mm Dia.
Dimension 1500mm Dia. x 30mm (t)

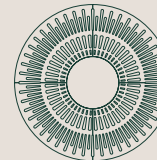

81119 **FIREWORK R1800/600**
Inner Well 600mm Dia.
Dimension 1800mm Dia. x 30mm (t)

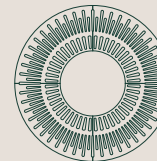

81120 **FIREWORK R1800/750**
Inner Well 750mm Dia.
Dimension 1800mm Dia. x 30mm (t)

COLLECTION
CONCENTRIC

This collection has the maximum expandability of tree-wells, with a comprehensive combination that allows for various formations. A modern ADA-compliant design with light ports and an optional fixed cover.



83110 **CONCENTRIC S800**
Inner Well Dimension
350mm Dia. (expandable)
800W x 800L x 30mm (t)



83113 **CONCENTRIC S1000**
Inner Well Dimension
350mm Dia. (expandable)
1000W x 1000L x 30mm (t)



83116 **CONCENTRIC S1200**
Inner Well Dimension
350mm Dia. (expandable)
1200W x 1200L x 30mm (t)

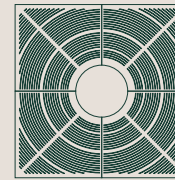

83119 **CONCENTRIC S2000**
Inner Well Dimension
600mm Dia. (expandable)
2000W x 2000L x 30mm (t)

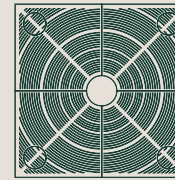

83120 **CONCENTRIC S2000 (w/light port covers)**
Inner Well Dimension
350mm Dia. (expandable)
2000W x 2000L x 30mm (t)



83111 **CONCENTRIC R800**
Inner Well Dimension
350mm Dia. (expandable)
800mm Dia. x 30mm (t)



83114 **CONCENTRIC R1000**
Inner Well Dimension
350mm Dia. (expandable)
1000mm Dia. x 30mm (t)



83117 **CONCENTRIC R1200**
Inner Well Dimension
350mm Dia. (expandable)
1200mm Dia. x 30mm (t)

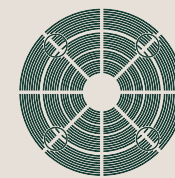

83121 **CONCENTRIC R2000 (w/ light port covers)**
Inner Well Dimension
350mm Dia. (expandable)
2000mm Dia. x 30mm (t)

COLLECTION
WHEEL

The axle of the wheel inspired these elegant designs. Optional reducers can be used to accommodate the expandability of the tree-well. They can be used individually or as a combined set for a smaller tree-well.



85113 **WAGON WHEEL REDUCER R800**
Inner Well 500mm Dia.
Dimension 800mm Dia. x 30mm (t)

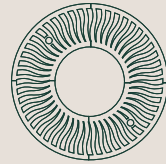

85112 **WAGON WHEEL R1800**
Inner Well 800mm Dia.
Dimension 1800mm Dia. x 30mm (t)



85110 **FIRE WHEEL R1000**
Inner Well 400mm Dia.
Dimension 1000mm Dia. x 30mm (t)

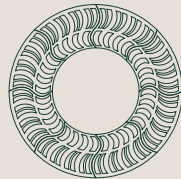

85111 **FIRE WHEEL R2000**
Inner Well 1000mm Dia.
Dimension 2000mm Dia. x 30mm (t)



87110 **BURNING SUN R1200**
Inner Well 400mm Dia.
Dimension 1200mm Dia. x 30mm (t)

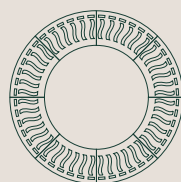

87113 **BURNING SUN R2000**
Inner Well 1200mm Dia.
Dimension 2000mm Dia. x 30mm (t)



95110 **THREAD-BALL R1500**
Inner Well 560mm x 560mm
Dimension 1500mm Dia. x 30mm (t)

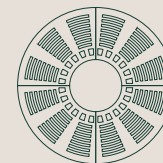

88111 **CARRIAGE R1800**
Inner Well 600mm Dia.
Dimension 1800mm Dia. x 30mm (t)



COLLECTION
STARGRATE

The designs in this collection express an explosion burst that resembles a star. Specific models come with optional light ports and inner ring expandability.



91110 **STARGRATE R1500**
Inner Well 700mm Dia.
Dimension 1500mm Dia. x 30mm (t)

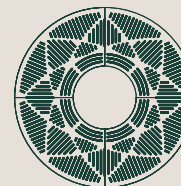

91112 **STARGRATE R2000/700**
Inner Well 700mm Dia.
Dimension 2000mm Dia. x 30mm (t)

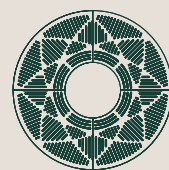

91111 **STARGRATE R1800**
Inner Well 600mm Dia.
Dimension 1800mm Dia. x 30mm (t)

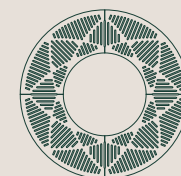

91113 **STARGRATE R2000/980**
Inner Well 980mm Dia.
Dimension 2000mm Dia. x 30mm (t)



COLLECTION
PEBBLE HOLE

The Pebble Hole Collection comprises of different panels to form a variety of formation, with limited expandability. Well-suited for huge existing trees that are off-centre from the typical tree grate configurations.



92116 **PEBBLE-HOLE R1000**
Inner Well 450mm Dia.
Dimension 1000mm Dia. x 30mm (t)

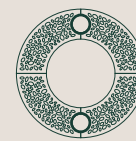

92118 **PEBBLE-HOLE R1500 (w/ light ports)**
Inner Well 800mm Dia.
Dimension 1500mm Dia. x 30mm (t)

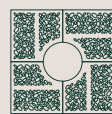

92117 **PEBBLE-HOLE S1200**
Inner Well 450mm Dia.
Dimension 1200W x 1200L x 30mm (t)

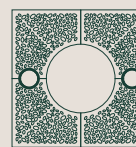

92119 **PEBBLE-HOLE S1600 (w/ light ports)**
Inner Well 800mm Dia.
Dimension 1600W x 1600L x 30mm (t)

COLLECTION
**LARGE TREE
GRATE**

Beautiful reinforced stone grates with expandable tree-well created explicitly for large trees. Available in 2 types of designs: a minimalistic Central design with simple lines and ornate Fallen Leaves.



94110 **FALLEN LEAVES R2000**
Inner Well 600mm Dia.
Dimension 2000mm Dia. x 30mm (t)

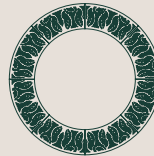

94111 **FALLEN LEAVES R3000**
Inner Well 2000mm Dia.
Dimension 3000mm Dia. x 30mm (t)

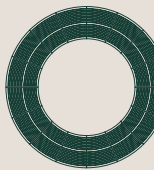

93110 **CENTRAL R4000**
Inner Well 2400mm Dia.
Dimension 4000mm Dia. x 30mm (t)

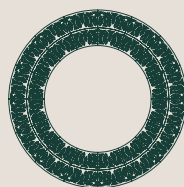

94112 **FALLEN LEAVES R5000**
Inner Well 3000mm Dia.
Dimension 5000mm Dia. x 30mm (t)

COLLECTION
PANEL GRATE

These square and rectangular cut panel grates provide enhanced aesthetic flair. This collection comprises panels in various shapes and sizes to form any formation.

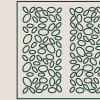

92112 **PEBBLE-HOLE 600**
Dimension 600W x 600L x 30mm (t)

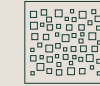

90110 **SQUARE MOSAIC 500**
Dimension 500W x 500L x 30mm (t)

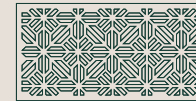

89110 **STARCUT 1200**
Dimension 600W x 1200L x 30mm (t)

COLLECTION
ADA

This wheelchair-friendly collection expands walking space for all pedestrians for greater accessibility. Available to suit a range of themes.

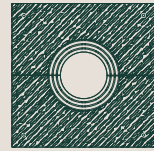

U41110 **CHISELED S1200**
Inner Well 390/460/530/600mm Dia.
Dimension 1200W x 1200L x 30mm (t)

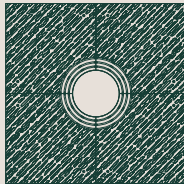

U41111 **CHISELED S1500**
Inner Well 390/460/530/600mm Dia.
Dimension 1500W x 1500L x 30mm (t)

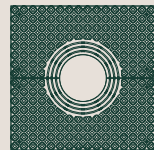

U42110 **CROSS-STITCH S1200**
Inner Well 390/460/530/600mm Dia.
Dimension 1200W x 1200L x 30mm (t)

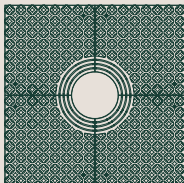

U42111 **KEYHOLES S1500**
Inner Well 390/460/530/600mm Dia.
Dimension 1500W x 1500L x 30mm (t)

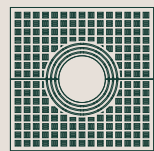

U43110 **CROSS-STITCH S1200**
Inner Well 390/460/530/600mm Dia.
Dimension 1200W x 1200L x 30mm (t)

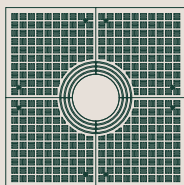

U43111 **CROSS-STITCH S1500**
Inner Well 390/460/530/600mm Dia.
Dimension 1500W x 1500L x 30mm (t)

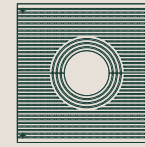

U44110 **INTERLACE S1200**
Inner Well 390/460/530/600mm Dia.
Dimension 1200W x 1200L x 30mm (t)

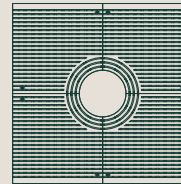

U44111 **INTERLACE S1500**
Inner Well 390/460/530/600mm Dia.
Dimension 1500W x 1500L x 30mm (t)



U45110 **PALM S1200**
Inner Well 390/460/530/600mm Dia.
Dimension 1200W x 1200L x 30mm (t)

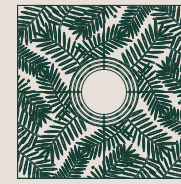

U45111 **PALM S1500**
Inner Well 390/460/530/600mm Dia.
Dimension 1500W x 1500L x 30mm (t)

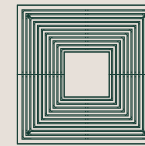

U46110 **SQUARE-SLOTS S1200**
Inner Well 390Wx390L Dia.
Dimension 1200W x 1200L x 30mm (t)

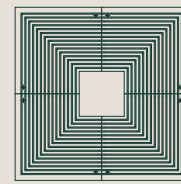

U46111 **SQUARE-SLOTS S1500**
Inner Well 390Wx390L Dia.
Dimension 1500W x 1500L x 30mm (t)



03
PRODUCTS



POOL GRATES

General Information	62
Baby Pebble	64
Chiseled Rain	66
Components	68

Pool Grates

Optional Features and Accessories

With its natural beauty and suitability superior to natural granite, Jonite swimming pool grates make for the perfect pool grating. We design our pool grates for overflow swimming pools. Pool surface flushes with the overflow tiles and grills, creating a perfect match for water line and nature.

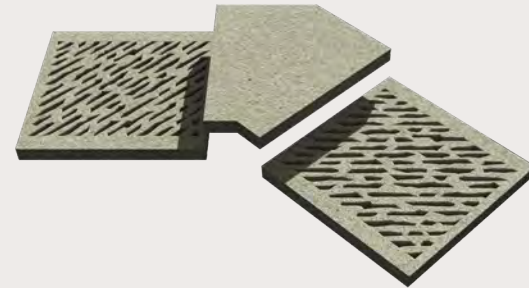

Handgrip-Trimmers™

Handgrip-Trimmers™ is a safety feature that can be installed along the pool perimeter to allow a safer grip while getting out of a pool.



Stud Trimmers™

Pools that require more water drainage to prevent splash can use Stud-Trimmers™ with the pool grates to help improve the flow rates of the perimeter drains.

Grate Tiles™

Grate Tiles™ are standard non-perforated solid slabs that have the same material composition and colour as Jonite grates. They are mainly used when a drain encounters an irregular joint or to fill an odd end of a drain.



Custom Curve Grates

Curve grates are available in any radius and design upon request. All radius in a plan will be consolidated in a full-scale CAD drawing to help minimize the number of custom toolings required.

GENERAL SPECIFICATIONS

Swimming pools are no longer seen just as an amenity; today, they are part of an enticing landscape. A swimming pool can make or break an entire hardscape design.

Overflow pools are the most common type of pool in residential and commercial properties. Landscape architects can express their vision by introducing various shapes, colours, and tiles to make something completely different.

Jonite swimming pool gratings bring in natural stone beauty that adds a high-end elegance reminiscent of ancient Greece and luxurious Roman pools. Our capabilities to create custom pool grates upon request help bring your ideas to life.

Our swimming pool grates have excellent natural slip resistance, making it comfortable and safe for both children and adults, especially in frequently wet areas. The small elliptical holes of baby pebbles and thin slit slots of the chiseled rain design collection eliminate the danger of toddlers catching their toes in the grating. Our pool grates are also heat resistant, which makes the gratings more comfortable to step on in the heat of the midday sun.

Our pool gratings have a low water absorption rate of 0.5%. They maintain their colour when in contact with pool water, unlike natural stone slabs, which can discolour when in contact with water. Our pool grates are built using composite reinforcements, ensuring longevity in the swimming pool as it is corrosion-resistant.

We believe in sustainable living and preserving the environment for future generations. It is this belief that drives us in our commitment to using at least 30% recycled content in our products.

PRODUCT SPECIFICATIONS



Toddler-safe

Colour durability due to low water absorption

Slip-resistant

Heat resistant

Environmentally-friendly

LOADING SPECIFICATIONS



A15

Strictly for pedestrian application only



COLLECTION
BABY PEBBLE

Jonite Baby Pebble Pool Grate Collection consists of 3 standard sizes. Designed to be toddler-friendly, this contemporary collection with small slots will add character to the pool.



65110 **BP245H25**
Load class 6 KN
Drain width 190 to 215mm
Dimension 245W x 300L x 25mm (t)

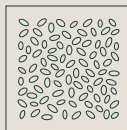

65111 **BP300H25**
Load class 6 KN
Drain width 240 to 270mm
Dimension 300W x 300L x 25mm (t)

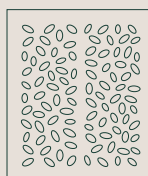

65112 **BP350H30**
Load class 6 KN
Drain width 280 to 310mm
Dimension 350W x 300L x 30mm (t)

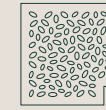

67110C **90° BP245H25**
Component BP Corner-Grate
Suitable for BP245H25

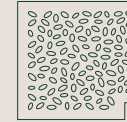

67111C **90° BP300H25**
Component BP Corner-Grate
Suitable for BP300H25

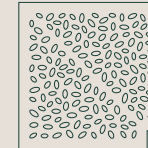

67112C **90° BP350H30**
Component BP Corner-Grate
Suitable for BP350H30

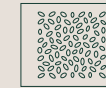

67113C **BE-BP245H25**
Component 50mm BLANK-ENDS for BP245H25
Dimension 245W x 300L x 25mm (t)

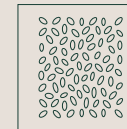

67114C **BE-BP300H25**
Component 50mm BLANK-ENDS for BP300H25
Dimension 300W x 300L x 25mm (t)

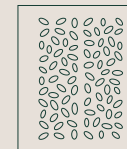

67115C **BE-BP350H30**
Component 50mm BLANK-ENDS for BP350H25
Dimension 350W x 300L x 30mm (t)

COLLECTION
CHISELED RAIN

Available in 3 standard sizes, the Chiseled Rain collection has an avant-garde design that will add a touch of sophistication in your pool designs.

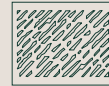

66110 **CR245H25**
Load class 6 KN
Drain width 190 to 215mm
Dimension 245W x 300L x 25mm (t)



66111 **CR300H25**
Load class 6 KN
Drain width 240 to 270mm
Dimension 300W x 300L x 25mm (t)

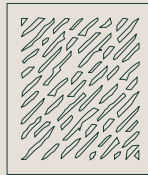

66112 **CR350H30**
Load class 6 KN
Drain width 280 to 310mm
Dimension 350W x 300L x 30mm (t)



68110C **90° CR245H25**
Component CR Corner-Grate
Suitable for CR245H25



68111C **90° CR300H25**
Component CR Corner-Grate
Suitable for CR300H25



68112C **90° CR350H30**
Component CR Corner-Grate
Suitable for CR350H30

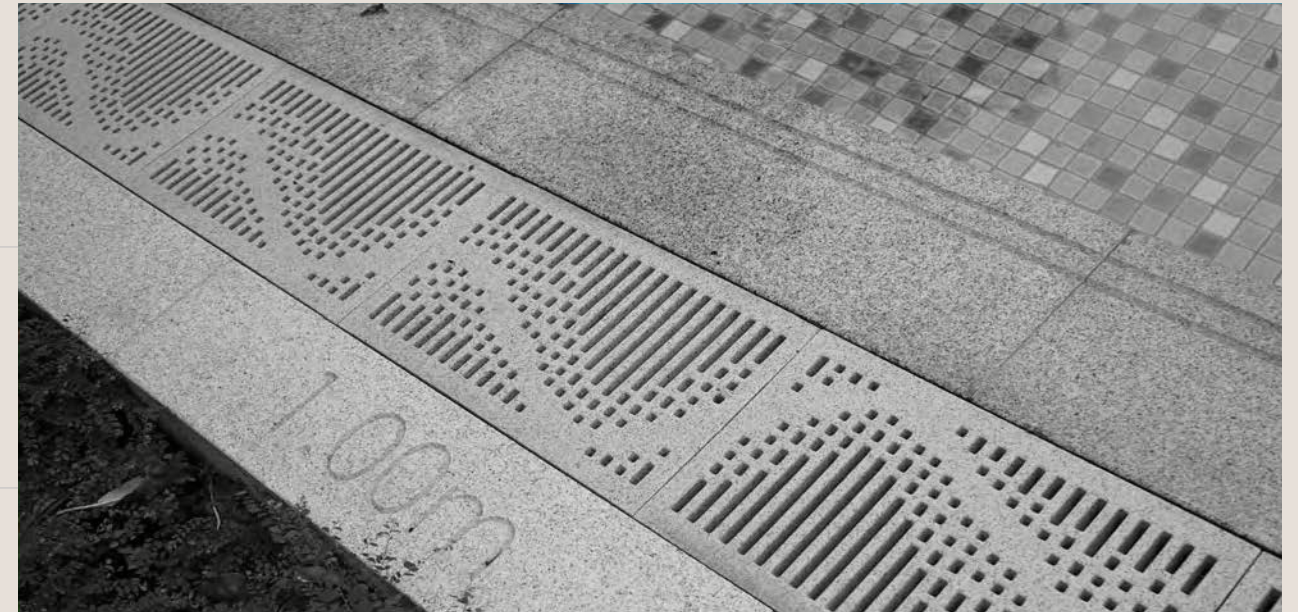

68113C **BE-CR245H25**
Component 50mm BLANK-ENDS for CR245H25
Dimension 245W x 300L x 25mm (t)



68114C **BE-CR300H25**
Component 50mm BLANK-ENDS for CR300H25
Dimension 300W x 300L x 25mm (t)



68115C **BE-CR350H30**
Component 50mm BLANK-ENDS for CR350H30
Dimension 350W x 300L x 30mm (t)

COLLECTION
**POOL GRATE
COMPONENTS**

These additional components help ease the installation for Jonite pool grates and also provide a bonus of aesthetic flair.

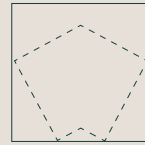

69110C **PGT-400H25**
Component POOL GRATE-TILE (regular)
Dimension 400W x 400L x 25mm (t)

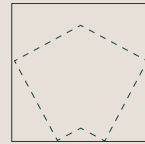

69112C **PGT-400H30**
Component POOL GRATE-TILE (regular)
Dimension 400W x 400L x 30mm (t)

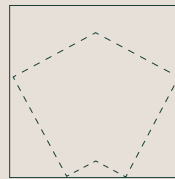

69111C **PGT-500H25**
Component POOL GRATE-TILE (large)
Dimension 500W x 500L x 25mm (t)

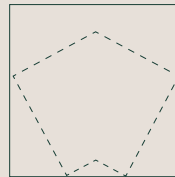

69113C **PGT-500H30**
Component POOL GRATE-TILE (large)
Dimension 500W x 500L x 30mm (t)

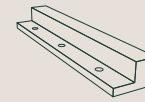

69114C **L-TRIMMER 25-PG**
Suitable for All Pool Grates of 25mm (t)
Dimension 60W x 300L x 35mm

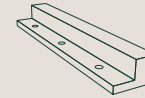

69115C **L-TRIMMER 30-PG**
Suitable for All Pool Grates of 30mm (t)
Dimension 60W x 300L x 40mm

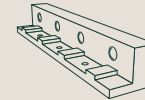

69116C **STUDS-TRIMMER 25-PG**
Suitable for All Pool Grates of 25mm (t)
Dimension 60W x 300L x 40mm

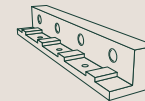

69117C **STUDS-TRIMMER 30-PG**
Suitable for All Pool Grates of 30mm (t)
Dimension 60W x 300L x 45mm

03
PRODUCTS



SUMP COVER

General Information	72
Slotted	74
High Performance	78
Basin Grates	80

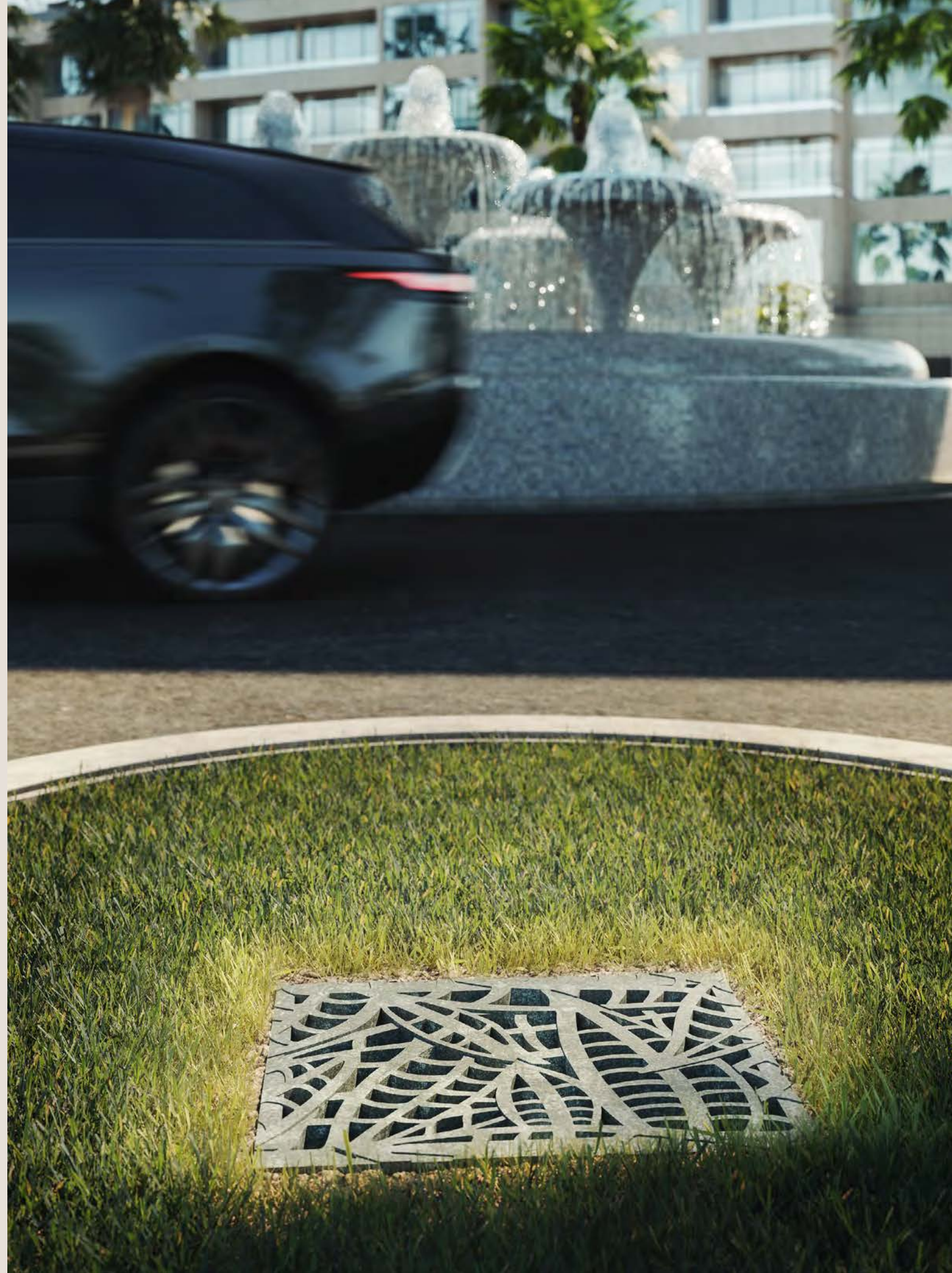

Sump Cover

Optional Features and Accessories

Add natural, modern stone aesthetics to your designs for point drainage systems. Our reinforced stone technology ensures that you can incorporate elegant stone into your design while ensuring optimum load strength.

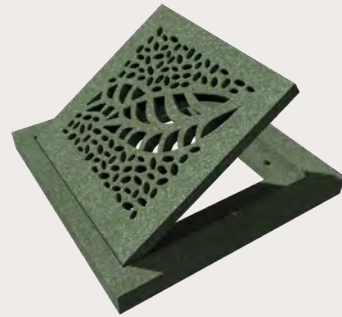

Custom Lockables

Custom lockable sump covers are available upon request and can be available for all applications and sizes. L-Trimmer Frames™ is optional.



Custom Hinged

Custom hinged sump covers are available upon request though they are limited to specific applications and sizes. The exposed hinge components are made of stainless steel with weather-proof polyurethane dampers.

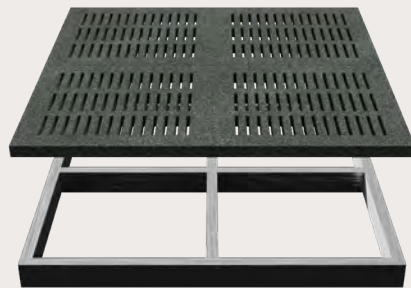

L-Trimmer Frames™

L-Trimmer Frames™ is mainly used for supporting sump covers, especially for heavy-duty applications. They provide a perfectly flat surface and seating allowance to maximise the performance of the sump cover.

Large Custom Sump Covers

A custom metal supporting frame can be designed to help support large sump covers with multiple panels.

GENERAL SPECIFICATIONS

The humble sump cover, or maintenance hole cover, first began life in the Roman Empire as slabs of stone or wood placed over point drainage systems that allowed maintenance workers access to covered drains carrying wastewater and sewage.

This omnipresent sump cover is the basis of inspiration for Jonite's designs, in which we aim to showcase the beauty of stone with modern technology and excellent craftsmanship.

Today, point drainage systems are found everywhere in the streets, commercial factory areas, residential areas, and more. Point drains require covers to prevent environmental contamination and prevent accidental falls. With Jonite point drain covers and sump grates, architects no longer face the problem of having to place these openings in inconspicuous areas, but instead can use these catch basin grates as an additional design element.

Lower urban temperatures by choosing Jonite sump covers with low heat absorption compared to traditional metal or cast iron grates. Traditional metal or cast iron grates absorb heat during the day, which can create the urban heat island effect through the raised temperature for surrounding buildings. Jonite sump covers were designed to combat the effects of urban warming, which is rapidly becoming a severe issue for cities in the changing climate.

The unique material properties of Jonite products prevent rust and corrosion such that they are equally suited to last a lifetime for both indoor and outdoor applications. It is also theft-resistant, as Jonite hardscape products do not pose any value for scrap due to their stone material integrity.

Jonite catch basin grates and sump grates come in a wide range of standard sizes that can be assembled with the addition of Jonite splines to form huge covers. This feature gives you the added edge of cost-effectiveness and sustainability. For multiple sump covers, a metal sub-frame may be used. Optional Jonite Trimmer Frames can be used to provide aesthetic flair and high-performance support for the heavy-duty channel and sump grates.

PRODUCT SPECIFICATIONS

- ↓
- Low heat absorption
- Rust and corrosion resistant
- Extreme strength and durability
- BS EN 124:2015 & 1433:2002 compliant
- Dielectric properties with excellent electric insulator
- Flexible sizes with the use of Jonite splines to form huge covers

LOADING SPECIFICATIONS

- ↓
- Class A15 - Class D400



COLLECTION
SLOTTED

Sump covers with classic slotted designs in a variety of standard sizes and shapes for quick matches to your designs.



51110 **SC300-300H25LD**
Load class A15
Pit Size 250 x 250mm
Dimension 300W x 300L x 25mm (t)



51111 **SC300-300H35HD**
Load class B125
Pit Size 230 x 230mm
Dimension 300W x 300L x 35mm (t)



51112 **SC300-600H25LD**
Load class A15
Pit Size 230 x 230mm
Dimension 300W x 600L x 25mm (t)

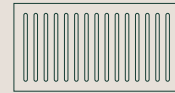

51113 **SC300-300H35HD**
Load class B125
Pit Size 240 x 540mm
Dimension 300W x 600L x 35mm (t)

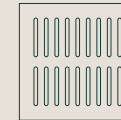

51120 **SC400-400H35LD**
Load class A15
Pit Size 350 x 350mm
Dimension 400W x 400L x 35mm (t)

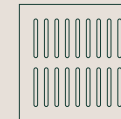

51121 **SC400-400H35HD**
Load class B125
Pit Size 340 x 340mm
Dimension 400W x 400L x 35mm (t)

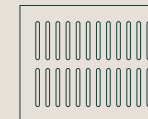

51122 **SC400-500H35LD**
Load class A15
Pit Size 350 x 450mm
Dimension 400W x 500L x 35mm (t)

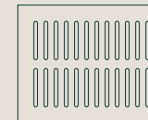

51123 **SC400-500H35HD**
Load class B125
Pit Size 340 x 440mm
Dimension 400W x 500L x 35mm (t)

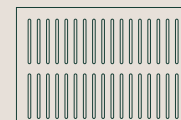

51124 **SC420-625H35LD**
Load class A15
Pit Size 370 x 575mm
Dimension 420W x 625L x 35mm (t)

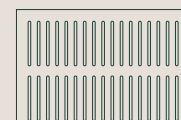

51125 **SC420-625H35HD**
Load class B125
Pit Size 360 x 565mm
Dimension 420W x 625L x 35mm (t)

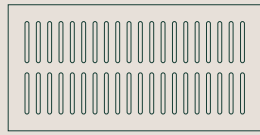

51126 **SC435-873H35LD**
 Load class A15
 Pit Size 385 x 823mm
 Dimension 435W x 873L x 35mm (t)

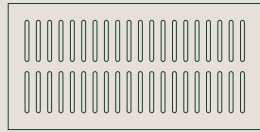

51127 **SC435-873H35HD**
 Load class B125
 Pit Size 375 x 813mm
 Dimension 435W x 873L x 35mm (t)

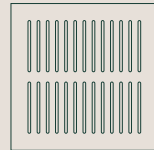

51128 **SC500-500H35LD**
 Load class A15
 Pit Size 450 x 450mm
 Dimension 500W x 500L x 35mm (t)

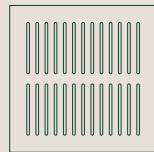

51129 **SC500-500H35HD**
 Load class B125
 Pit Size 440 x 440mm
 Dimension 500W x 500L x 35mm (t)

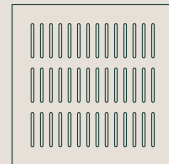

51130 **SC550-550H35LD**
 Load class A15
 Pit Size 500 x 500mm
 Dimension 550W x 550L x 35mm (t)

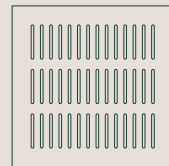

51131 **SC550-550H50HD**
 Load class B125
 Pit Size 490 x 490mm
 Dimension 550W x 550L x 50mm (t)



53110C **TRF300-300H25**
 Suitable for SC300-300H25LD



53111C **TRF300-300H35**
 Suitable for SC300-300H35HD

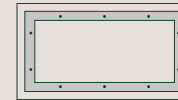

53112C **TRF300-600H25**
 Suitable for SC300-600H25LD

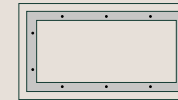

53113C **TRF300-600H35**
 Suitable for SC300-600H35HD

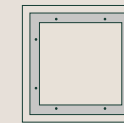

53114C **TRF400-400H35**
 Suitable for SC400-400H35LD / HD

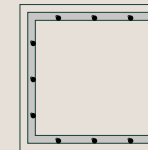

53115C **TRF500-500H35**
 Suitable for SC500-500H35LD / HD

COLLECTION
**HIGH
PERFORMANCE**

Reinforced stone sump covers, specifically created to withstand heavy vehicular loads up to 400KN. Available in various sizes.

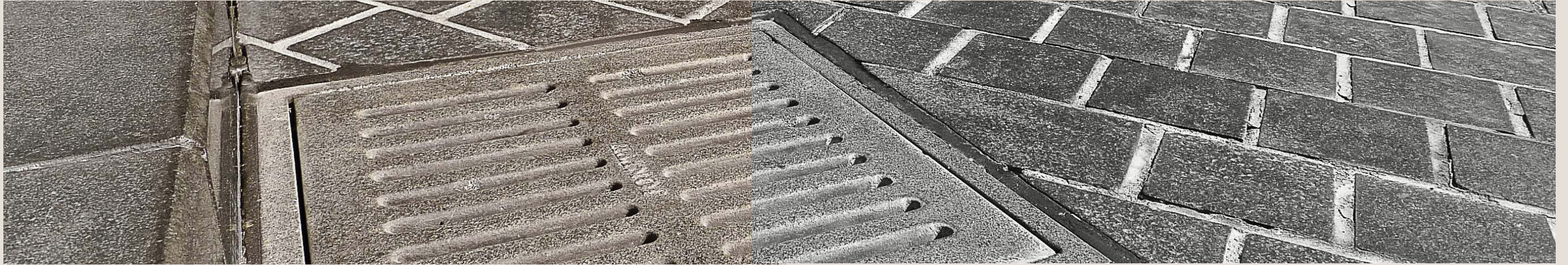

52120 **SSC300-600H35EHD**
Load class C250
Pit Size 230 x 530mm
Dimension 300W x 600L x 35mm (t)

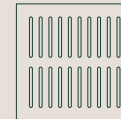

52122 **SSC400-400H50EHD**
Load class C250
Pit Size 340 x 340mm
Dimension 400W x 400L x 50mm (t)



52121 **SSC300-600H50CHD**
Load class D400
Pit Size 230 x 530mm
Dimension 300W x 600L x 50mm (t)

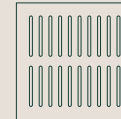

52123 **SSC400-400H75CHD**
Load class D400
Pit Size 330 x 330mm
Dimension 400W x 400L x 75mm (t)



52110 **SSC350-700H50EHD**
Load class C250
Pit Size 280 x 630mm
Dimension 350W x 700L x 50mm (t)

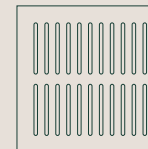

52118 **SSC500-500H50EHD**
Load class C250
Pit Size 430 x 430mm
Dimension 500W x 500L x 50mm (t)



52117 **SSC350-700H75CHD**
Load class D400
Pit Size 280 x 630mm
Dimension 350W x 700Lx 75mm (t)

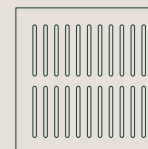

52119 **SSC500-500H75CHD**
Load class D400
Pit Size 430 x 430mm
Dimension 500W x 500L x 75mm (t)

COLLECTION
BASIN GRATES

Perfectly shaped to be compatible with the most common catch basins in the USA, Jonite reinforced stone Basin Grates can be matched to other Jonite products for a seamless finish through your design.

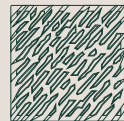

U31110 **BG-CHISELED-300**
Load class A15
Dimension 300W x 300L x 29/32mm (t)

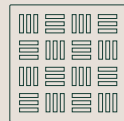

U31111 **BG-CROSS-STITCH-300**
Load class A15
Dimension 300W x 300L x 29mm (t)

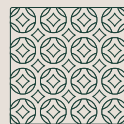

U31112 **BG-KEYHOLES-300**
Load class A15
Dimension 300W x 300L x 29/32mm (t)

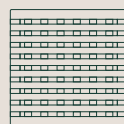

U31113 **BG-INTERLACE-300**
Load class A15
Dimension 300W x 300L x 29/32mm (t)

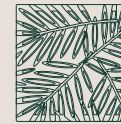

U31114 **BG-PALM-300**
Load class A15
Dimension 300W x 300L x 29/32mm (t)

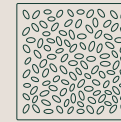

U31115 **BG-PEBBLES-300**
Load class 6KN
Dimension 300W x 300L x 29mm (t)

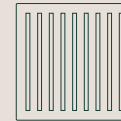

U31116 **BG-SQUARE-SLOTS-300**
Load class A15
Dimension 300W x 300L x 29mm (t)



03
PRODUCTS
→

**BATHROOM
GRATES**

General Information	84
Slotted	86
Waveline	88

Bathroom Grates

Toilets redefined

Inventors of the world's first reinforced stone bathroom grates. An aesthetically pleasing and cost-effective alternative to stainless steel grates. More than merely bathroom drain covers, we think of our bathroom gratings as a culmination of ancient history and modern technology. With natural stone textures, Jonite bathroom grates add a modern and elegant flair to public bathrooms.

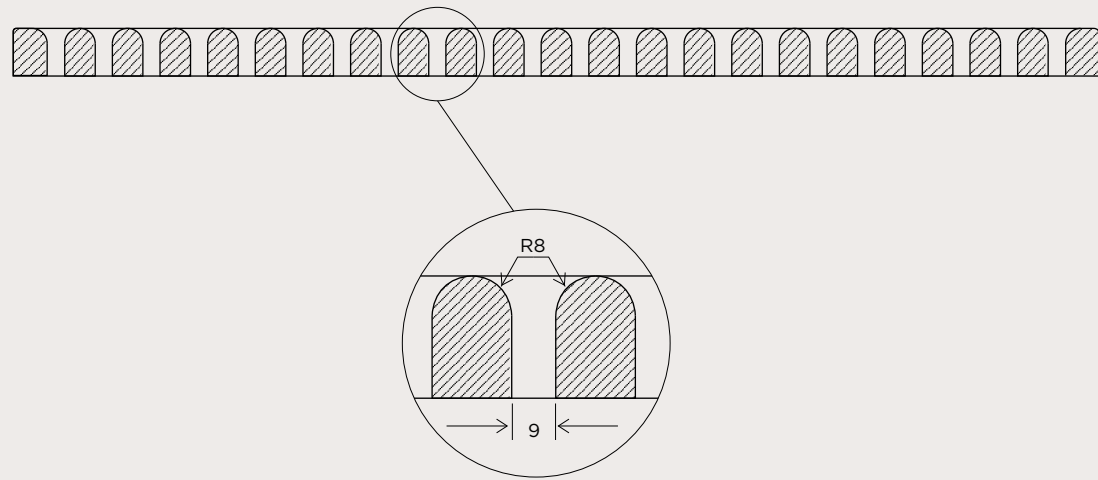

Slotted

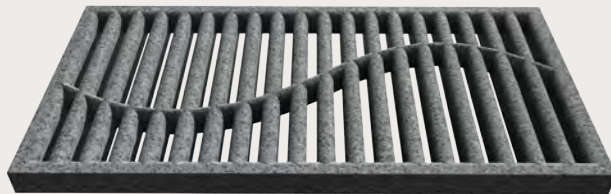

Waveline

Rounded Edge Profiles

With its specially rounded curve profiles, liquids are easily flushed away from the surface of the grates. This prevents any liquids from stagnating on the surface as well as easy cleaning and maintenance. Even with the rounded curve profiles, the matte stone texture still provides natural slip resistance.

Customisation

Jonite Bathroom Grates comes in two standard designs, the Slotted and the Waveline. They are fully customisable, in terms of colours, designs, sizes and textures, they are all available upon request.

GENERAL SPECIFICATIONS

Jonite created the world's first reinforced stone bathroom grates. In the past, the only option for architects when designing drainage coverings for public toilets was stainless steel grates which were expensive and slippery.

Now, countless architects have used Jonite bathroom grates in public bathrooms to create modern, beautiful, hygienic, and safe toilets.

Beautifully crafted and created to drain excess and wastewater effectively, Jonite bathroom grates are used in urinals, cubicles, and even washbasins in public bathrooms. Architects and interior designers choose our reinforced stone toilet gratings because our grates can be blended with the colours of floor tiles to create a seamless finish.

Our bathroom gratings' rounded curve profiles and matte stone textures also provide slip resistance. Furthermore, Jonite bathroom gratings are easy to maintain without the need for any acid wash and have low water absorption, minimizing the propensity to staining.

Jonite bathroom grates contribute toward satisfying MR Credit 4: Recycled Content under LEED®. The LEED® Green Building Rating System is the nationally accepted benchmark for the design, construction, and operation of high performance green buildings in the U.S.A..

A robust sewerage system for public bathrooms is so essential in providing a comfortable, clean, and pleasant experience for users. More than just serving a sanitation function, we believe that our bathroom and toilet grates are a culmination of ancient history. Stone featured prominently in classical Roman bathrooms and modern technology through the (reinforced) stone.

PRODUCT SPECIFICATIONS



Natural aesthetics

Slip-resistant

Less susceptible to stains

Easy to maintain

MR Credit 4: Recycled Content
accredited under LEED

LOADING SPECIFICATIONS



A15

Strictly for pedestrian application



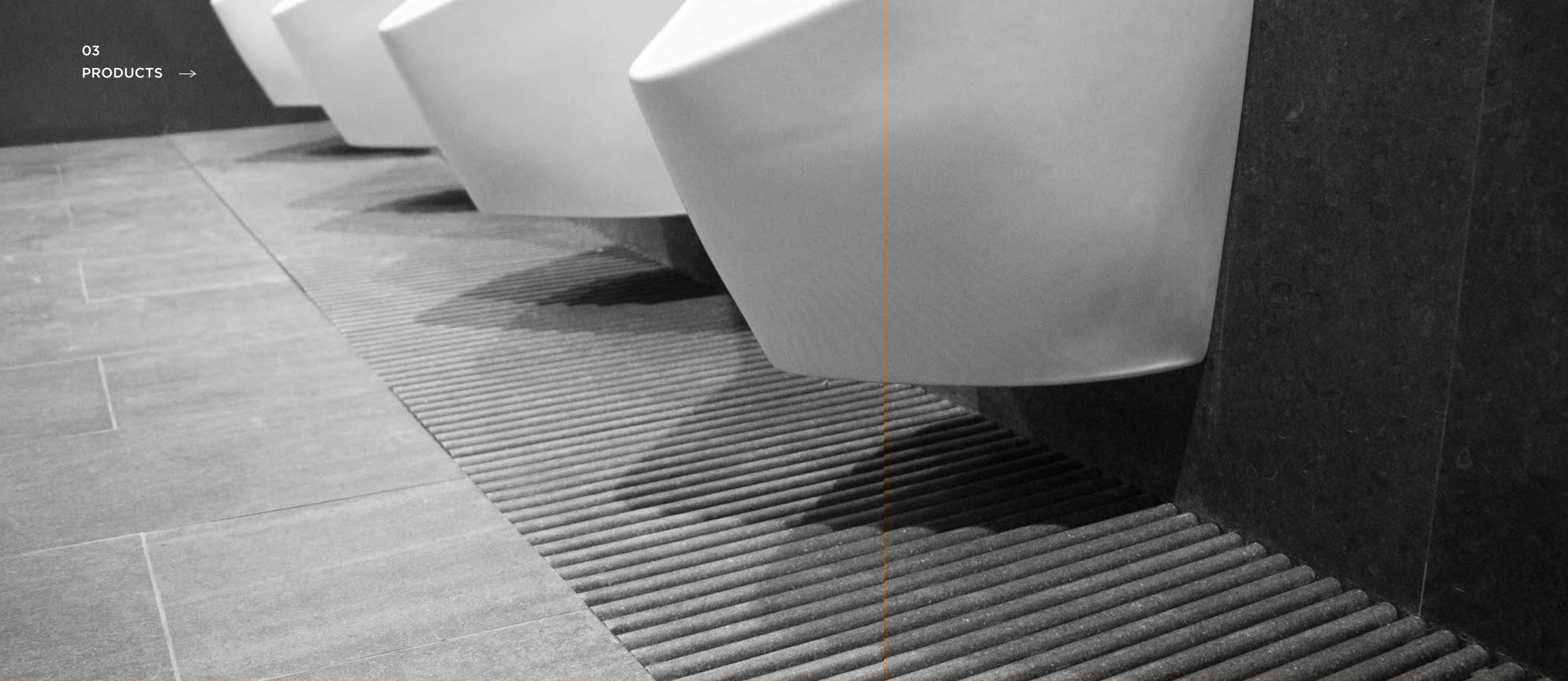

COLLECTION
SLOTTED

Minimalistic bathroom grate designs that blend in seamlessly with the bathroom floor.



12110 **TGS-200**
Load class A15
Drain width 159mm to 164mm
Dimension 200W x 500L x 25mm (t)



12112 **TGS-250**
Load class A15
Drain width 209mm to 214mm
Dimension 250W x 500L x 25mm(t)

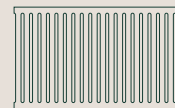

12113 **TGS-300**
Load class A15
Drain width 259mm to 264mm
Dimension 300W x 500L x 25mm (t)

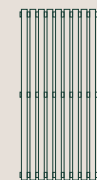

12114 **Bone-500**
Load class 6KN
Drain width 455mm to 464mm
Dimension 500W x 250L x 30mm (t)

COLLECTION
WAVELINE

This waves-inspired collection of bathroom grates lend a modern touch to the bathroom floor for an additional creative aesthetic.

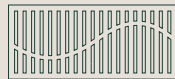

11110 **WAVELINE-185**
Load class A15
Drain width 150mm to 155mm
Dimension 185W x 500L x 20mm (t)



11112 **WAVELINE-220**
Load class A15
Drain width 179mm to 184mm
Dimension 220W x 500L x 25mm (t)



11113 **WAVELINE-250**
Load class A15
Drain width 209mm to 214mm
Dimension 250W x 500L x 25mm (t)

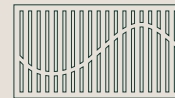

11114 **WAVELINE-275**
Load class A15
Drain width 234mm to 239mm
Dimension 275W x 500L x 25mm (t)



11115 **WAVELINE-500**
Load class 6KN
Drain width 459mm to 464mm
Dimension 500W x 250L x 25mm (t)

03
PRODUCTS



FLOOR DRAINS

General Information	92
Tile-Up	94
Driveway	94
Hinged	95
Classic	96
Modern	97



Floor Drains

Floor-bonded

Jonite's homogenous stone floor drains can match any tile to form a trap cover, achieving desired coherence with functional designs. We aim to continue designing floor drains that blend seamlessly into any flooring.



Tile-Up™ Collection

Clean, seamless and corrosion-free, our Tile-Up™ Collection uses existing floor tiles with slit gaps as the solution preferred by architects. An alternative to the usual option of raw concrete screeds, unstable covers and untidy holes, the Tile-Up™ Collection is aesthetically pleasing, easy to install and an effective system.



Classic Collection

The classic collection is exclusive with the use of Jonite stone, durable yet aesthetically pleasing. You will be pampered with a choice of 16 different standard colours or unlimited custom colours.



Hinged Collection

Do away with the hassle of handling of floor traps; our Hinged Collection is the perfect partner for applications that requires frequent access to the pipes for cleaning.



Modern Collection

Complete your drain application with style and practicality; our modern collection offers everything except the mundane features of a typical floor trap.



Odour & Insect Resistant

Jonite floor drains are designed to accommodate PVC strainers and foul-air restrainers to prevent insects and unpleasant odours from arising.

GENERAL SPECIFICATIONS

Once considered a luxury only for the rich in ancient Rome, the toilet or WC has become a familiar and necessary sight in the modern home. Many designers focus on various fixtures to provide comfort for their clients, but the humble floor drain is often overlooked.

However, adding floor drains and point drains is not only necessary and but also considered a great design because it enables easy toilet maintenance. Stagnant water in the toilets can damage the flooring in the long term and become a hotspot for mosquito breeding in the tropics. Good floor drains can prevent stagnant water from pooling up and can allow for some stains to be cleansed and removed.

Waterproofing is foremost in our floor drain cover designs, as is the prevention of infiltration by insects and foul air. Special PVC strainers and restrainers fitted with our floor drain traps work to achieve a cleaner environment, giving bathroom users a more pleasant and hygienic experience.

Jonite floor drains are engineered to fulfil crucial functions while remaining an integral component of the structural floor. Our most popular series is the Tile Up collection where any tile can be used to create a seamless look and feel throughout the bathroom.

Jonite floor drains are available in a wide range of standard colours developed to assist landscape architects in quickly picking the colour they need. More specialized colours are also possible with our colour customization process, allowing any hue or shade desired.

PRODUCT SPECIFICATIONS



Modern aesthetics

Easy to maintain

Extreme strength and durability

Prevents foul smells and insects

Special PVC strainers and restrainers fitted

LOADING SPECIFICATIONS



5KN

Strictly for pedestrian application



COLLECTION
TILE-UP

One of our most popular collections amongst interior designers, this collection enables you to use any tile to create a point drain cover with all of Jonite's floor drain functionalities.



7111 **FTUS-90/100**
Component Tile-up Trap (Shower Square)
Dimension 100W x 100L x 22mm (t)

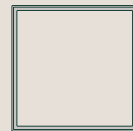

7110 **FTUS-148/158**
Component Tile-up Trap (Square)
Dimension 158W x 158L x 30mm (t)

COLLECTION
DRIVEWAY

Created specifically for use in driveway drainage, this collection is available in 2 standard designs.

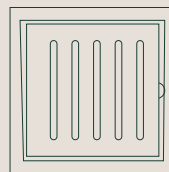

75110 **FHS-158/200HD**
Component Driveway Trap (B125)
Dimension 200W x 200L x 45mm (t)

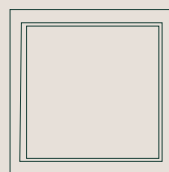

75111 **FHS-158/200HD Blank**
Component Driveway Trap Blank (B125)
Dimension 200W x 200L x 45mm (t)

COLLECTION
HINGED

Do away with the hassle of handling of floor traps; our Hinged Collection is the perfect partner for applications that requires frequent access to the pipes for cleaning.

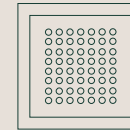

72113 **FHS-125/158**
Component Hinged Trap (Square)
Dimension 158W x 158L x 30mm (t)

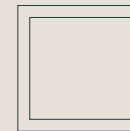

72114 **FHS-125/158 Blank**
Component Hinged Trap Blank
Dimension 158W x 158L x 30mm (t)

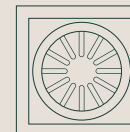

72115 **FHS-125/158 Dome**
Component Hinged Trap Dome
Dimension 158W x 158L x 30(45)mm (t)

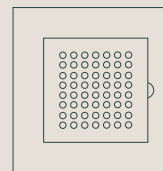

72110 **FHS-125/200**
Component Hinged Trap (Large)
Dimension 200W x 200L x 30mm (t)

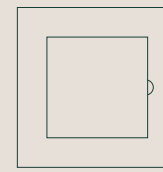

72111 **FHS-125/200 Blank**
Component Hinged Trap Blank (Large)
Dimension 200W x 200L x 30mm (t)

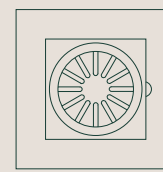

72112 **FHS-125/200 Dome**
Component Hinged Trap Dome (Large)
Dimension 200W x 200L x 30(45)mm (t)

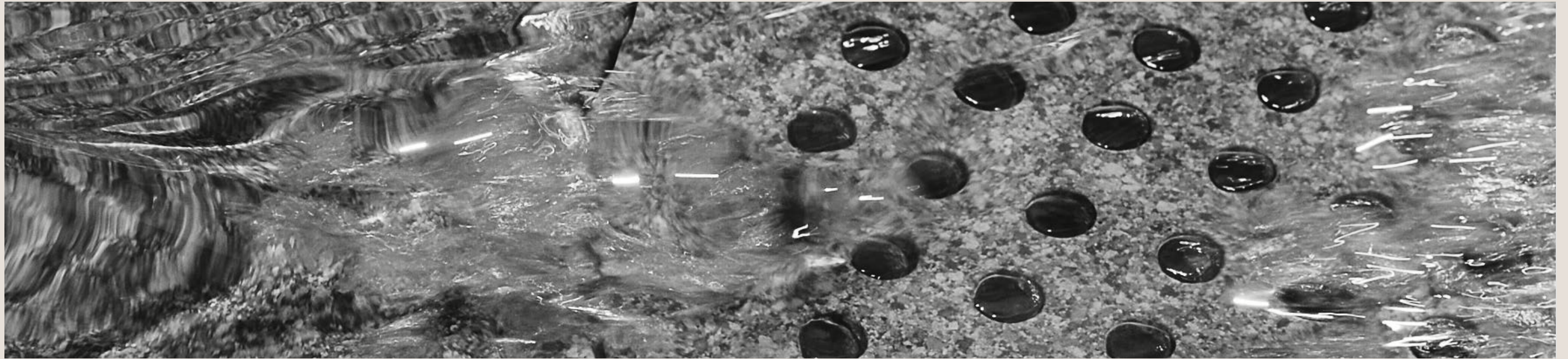

COLLECTION
CLASSIC

While retaining the features of conventional floor traps, the classic collection is exclusive with the use of Jonite stone, durable yet aesthetically pleasing.

COLLECTION
MODERN

The modern collection of floor drains complement minimalist designs while retaining its functionality and durability.



73112 **FCR90/100 Shower**
Component Classic Shower Trap (Round)
Dimension 100mm Dia. x 25mm (t)



74110 **FMAS-135/158**
Component Modern Americ Square
Dimension 158W x 158L x 30mm (t)

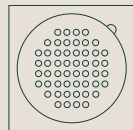

73111 **FCSR-135/158**
Component Classic Square Trap (with Round cover)
Dimension 158W x 158L x 30mm (t)



74111 **FMAR-145/165**
Component Modern Americ Round
Dimension 165mm Dia. x 30mm (t)

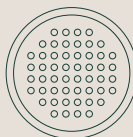

73110 **FCR-145/165**
Component Classic Round Trap
Dimension 165mm Dia. x 30mm (t)



74112 **FMSR-145/165**
Component Modern Slotted
Dimension 165mm Dia. x 30mm (t)



03
PRODUCTS
→

**VENTILATION
GRILLES**

Forest	100
General Information	101

Ventilation Grilles

One of our newest lines of products, the ventilation grate is a natural extension of our existing reinforced stone hardscape products. Ventilation can now be beautiful and multi-purpose, enabled by our highly customizable designs and excellent load-bearing strength.



COLLECTION FOREST

Inject tropical vibes into your design with this collection of reinforced stone ventilation grilles inspired by the forest.



65110 FOREST-VG-300
 Drain width 250mmW (max.)
 Dimension 300W x 500L x 25mm (t)



6511 FOREST-VG-445
 Drain width 385mmW (max.)
 Dimension 445W x 490L x 35mm (t)

GENERAL SPECIFICATIONS

Ventilation is of primary concern to architects. When designed well, it can make a building come alive and can help building owners achieve green energy savings through improved ventilation. Every building design is unique. Therefore the Net Free Area requirements for ventilation grilles can vary vastly.

Here at Jonite, with over 20 years of experience in the materials industry partnering with landscape architects, we understand this deeply. All of our decorative ventilation grilles can be customized to fit your requirements for open area percentage of ventilation, span, or design.

Traditional metal ventilation grilles are typically highly functional but non-decorative. We design our ventilation grilles with the aspiration of bringing an exciting alternative to aluminium or metallic alloy ventilation grilles through the introduction of beautiful reinforced stone products.

Architects can expand their hardscape, and urban designs to anywhere their imagination bring them. Ventilation grilles no longer need to be hidden, concealed, or minimized- but can become an entire design highlight or blended into the other hardscape design elements.

Leverage on Jonite ventilation grilles' excellent load-bearing strength, architects can now incorporate ventilation in other applications that were not possible in the past. Architects have used the power of our grates to circumvent safety issues of ventilation being situated directly above the basement car parks. Other architects have used Jonite custom ventilation grilles for multiple purposes as both ventilation and a walking platform. This custom feature opens up an exciting avenue to express creativity and create something unique. The possibilities are endless, as you can specify it and we can custom-build it.

PRODUCT SPECIFICATIONS

- ↓ Highly customizable
- Beautiful modern aesthetics
- Excellent load-bearing strength
- Unlimited colours and designs

LOADING SPECIFICATIONS

- ↓ 5KN - Class D400





03
PRODUCTS



BREEZE BLOCKS

General Information	104
ModuBloc	107
Elementa	107

Breeze Blocks

Elevate your designs with Jonite Breeze Blocks, an emblem of architectural sophistication within our exclusive stone composite product range. Enhance landscapes, hardscapes, and interiors across residential and commercial domains, embodying a vision of unmatched grace and allure.



Authentic Stone Appeal

Immerse yourself in the enduring allure of stone, impeccably captured in our diverse palette of colors and designs.

Exceptional Performance & Durability

Discover the unmatched strength and resilience of our proprietary Jonite stone composite material, setting a new standard in architectural excellence.

Sophisticated Self-Cleaning

Benefit from our cutting-edge self-cleaning technology with anti-algae properties, ensuring enduring beauty and effortless maintenance.

Unrivalled Customization

At Jonite, your design reigns. Personalize sizes, colours, patterns, strength, and open areas to create unique breeze blocks that authentically reflect your architectural vision.

GENERAL SPECIFICATIONS

Inspired by the collective brilliance of world-renowned architects, Jonite proudly presents the latest masterpiece in our premium architectural stone product portfolio – the Jonite Breeze Block. Developed by Jonite, this revolutionary product represents the ideal fusion of elegant design, superior materials, and state-of-the-art technology, appealing to the refined tastes of landscape architects, architects, and interior designers.

With Jonite Breeze Blocks, seamlessly enhance your external hardscape, landscape, and interior projects across residential and commercial developments, transforming your creations into architectural marvels.

Crafted from our proprietary Jonite stone composite material, renowned for its exceptional performance across our product range, the Jonite Breeze Block offers low water absorption, unmatched durability, high compressive strength, and an extensive variety of natural stone aesthetics. Our dedication to quality and innovation ensures that every Breeze Block stands as a testament to the enduring elegance of natural stone. Safety remains paramount in all architectural endeavours, and the Jonite Breeze Block adheres to this principle. Rigorously tested and certified Class 1 for flame spread according to BS 476: Part 7: 1997, you can confidently integrate Jonite Breeze Blocks into your designs, meeting the strictest safety standards.

The Jonite Breeze Block's unrivalled customization possibilities set it apart. Our diverse collection of designs and colours empowers you to realize your unique vision. For truly bespoke creations, our team of experts is ready to collaborate, crafting custom designs that encapsulate your artistic expression.

In addition, the Jonite Breeze Block features advanced anti-algae selfcleaning properties, ensuring enduring beauty with minimal maintenance. This innovative aspect guarantees pristine appearances while simplifying up keep.

Discover the harmonious blend of artistry and innovation with the Jonite Breeze Block, and elevate your architectural projects to unparalleled heights. Redefine design excellence with this exceptional product that skilfully unites form and function.

PRODUCT SPECIFICATIONS



Natural stone aesthetics

Class 1 fire rating

Low heat and water absorption

Anti-algae self cleaning

Bespoke customization



COLLECTION
MODUBLOC

Discover limitless potential with ModuBloc: Quadra's artful rectangular openings blend seamlessly with Bevel's distinguished sloping profile. Unite these versatile breeze blocks to create custom configurations that elevate your architectural landscape.

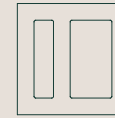

68100 **QUADRA-200**
Component Breeze Block (Square)
Dimension 200 x 200 x 75mm (t)

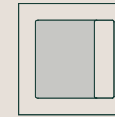

68200 **BEVEL-200**
Component Breeze Block (Square)
Dimension 200 x 200 x 75mm (t)

COLLECTION
ELEMENTA

Embrace the beauty of geometry with Elementa: Vista's continuous double triangles and Nexus's pristine, concentric circle enchant and inspire. Allow these singular, minimalist breeze blocks to command attention, amplifying the core of your design ethos.



68300 **VISTA-250**
Component Breeze Block (Rectangle)
Dimension 250 x 200L x 75mm (t)

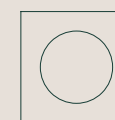

68400 **NEXUS-200**
Component Breeze Block (Square)
Dimension 200 x 200 x 75mm (t)



03
PRODUCTS



STREET BENCHES

General Information	110
BR	112
SS	113

Street Benches

Stone street furniture doesn't have to be heavy and bulky. It can be sleek and modern but still be able to withstand the elements — rain, sun, sleet, snow, or more. Jonite's versatile panels make the perfect site furnishing such as street benches.



Philosophy

The Banco Series is created using contemporary, ergonomic and versatile designs of structure elements such as pedestals and panels using various Jonite creative panels. Customisable with unlimited colours, patterns & textures.

Custom Design on Panel Grates

The Banco Benches can easily create exclusive designs representing a corporate insignia or municipal logo on the panel-grate, giving a unique identity to parks or commercial open spaces.

GENERAL SPECIFICATIONS

Street furniture plays a ubiquitous part of street design. When deciding on what type of site furnishing and where to place them, landscape architects not only have to consider aesthetics and functionality. The impact the street furniture has on road safety, pedestrian mobility, and the city's visual identity is also essential.

A growing movement in architecture is to provide green spaces as a counterbalance to modern city skylines. Architects have a fine line to tread between the balance of nature and modern architecture. Public areas such as parks are the perfect stages to accomplish this goal- and what better way to add a further touch of life through natural stone site furnishing?

Jonite's Banco street bench is a natural extension of our existing line of grates and panels. This new line of site furnishing offers a unified look throughout your design from drainage grates to street furniture.

Our Banco street benches are created to be ergonomic and versatile. Come in fully knock-down or pre-assembled systems to accommodate standard or customized components while being sturdy and cost-effective. Our R&D team worked towards a vision of sleek and modern designs, breaking the mould of large and heavy stone street benches.

Easily add creative and beautiful touches through the creation of unique designs featuring a corporate insignia or municipal logo on the panel-grate, giving an exclusive identity to the parks or commercial open spaces.

If you would like to go beyond street benches, our experienced R&D team can work with you to create custom street furniture and site furnishings for imaginative applications. Refreshing, exciting, and unified reinforced stone finishes in unexpected places will create a new depth in your designs.

At least 30% of our Banco street furniture is made of recycled products: this is our way of contributing to a green and sustainable environment.

PRODUCT SPECIFICATIONS



Sturdy & ergonomic

Extreme load-bearing strength

Customizable logos and designs

Low heat absorption

LOADING SPECIFICATIONS



5KN

Strictly for seating application



COLLECTION
BR

The BR series consists of street benches with ergonomic backing designed for the comfort of users. Available in 2-seater or 3-seater standard configurations.

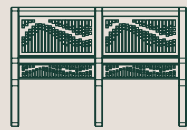

21110 **BR 300-2 SEATER**
Dimension 1150L x 823W x 780mmH

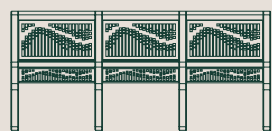

21111 **BR 300-3 SEATER**
Dimension 1700L x 823W x 780mmH

COLLECTION
SS

The SS series comprises of benches without backing, to provide uninterrupted sightlines, bringing the spotlight onto the natural surroundings. Available in 2 seating configurations.

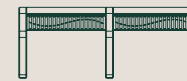

21112 **SS 210-2 SEATER**
Dimension 1150L x 638W x 447mmH



21113 **SS 210-3 SEATER**
Dimension 1700L x 638W x 447mmH



04
MAINTENANCE 116

05
LOADING
SPECIFICATIONS 117

06
INSTALLATION 118

Maintenance Accessories

Repair Kit

For small chips or cracks due to mishandling, our handy Repair Kit, a proprietary epoxy putty filler, can help to make needed repairs easily. It comes pre-mixed in standard or custom colours as required.



SealFix™ 103

SealFix™ 103 is a two-part epoxy mortar specially formulated for fixing Jonite components such as L-Trimmers™. It has high strength bonding, impermeable, chemical-resistant and suitable for 'dry-fixing'.



ArmorFix™ 108

All Jonite products are impregnated with a coat of ArmorFix™ 108, a clear stone sealer. It has very high compressive strength, remarkable cohesion, superior hardness and high wear resistance.



Kleansol™ 511

Kleansol™ 511 is a proprietary algae and stain removal solution specially formulated for Jonite products which might be badly soiled due to mishandling or accidents.



Lifting Hooks

The heaviest Jonite grates are designed to weigh less than 50kg, requiring a maximum of two people to lift. We recommend using these hooks for lifting heavy-duty grates.



Loading Specification

Compliant with BS EN 124:2015

Understanding Loads Affecting Grates:

Static Loads refers to load applied vertically to the grating with no other movement, such as a load from a stationary vehicle.

Wheel-loads refer to the weight of the vehicle and its typical load depending on the type of the wheels. Pneumatic tyres spread the load like the test-block in the illustration and solid tyres post a greater point load.

Vehicle movement, speed, braking and traffic frequency are the consolidated consideration of dynamic loads.

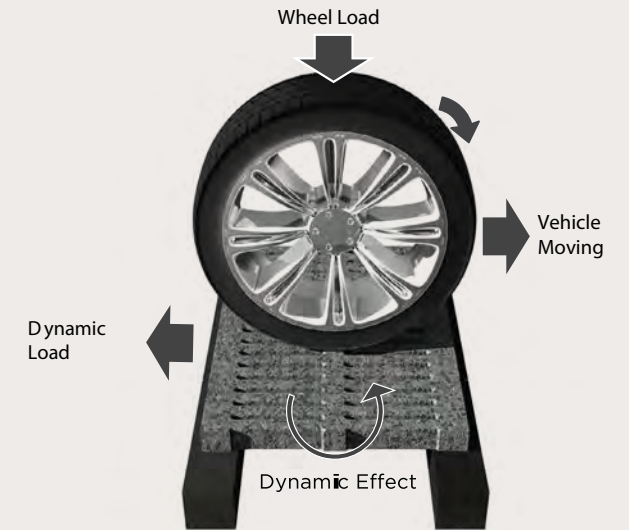

Selection Of Appropriate Load Class According To BS EN 124:2015



GROUP 01 CLASS A15

Areas strictly for pedestrians and pedal cyclists. House drains, pool decks, courtyards, park-walkways and pedestrian compounds within precincts.



GROUP 02 CLASS B125

Public footways and comparable areas, car porches and parks. Generally for slow-moving vehicles not exceeding 3 tonnes in wheel-load.



GROUP 03 CLASS C250

Used as curb-side grates in heavy vehicle parking areas and entrances of small precincts. Generally for slow-moving vehicles not exceeding 5.5 tonnes in wheel-load.



GROUP 04 CLASS D400

Carriageways of roads, hard-standing areas for fire-engine access and parking areas for heavy vehicles. Generally for slow-moving vehicles not exceeding 11.5 tonnes in wheel-load.

06
INSTALLATION
GUIDES



Trench Grates	120
Curve Grates	126
Grate Tiles	130
Tree Grates	132
Banco™	136
Pool Grates	146
Sump Covers	149

Trench Grates

Installation

Jonite trench grates can be installed in a wide variety of ways as they can vary worldwide. For trench grates, this mainly depends if you are introducing light-duty (pedestrian-rated) grates or heavy-duty (vehicular-rated) grates.

For light-duty applications, adopt Methods 1 and 2 by installing directly on a level concrete or L-steel angles for added support and flatness.

For heavy-duty applications, adopt Methods 3 and 4 by installing using Jonite L-Trimmers or with an inverted L-steel angle.

1 LIGHT-DUTY GRATES ON LEVEL CONCRETE

Only light-duty Jonite trench grates, which are strictly for pedestrian application (6KN-15KN), can be installed directly on level concrete as long as they are installed flatly with no visible rocking.

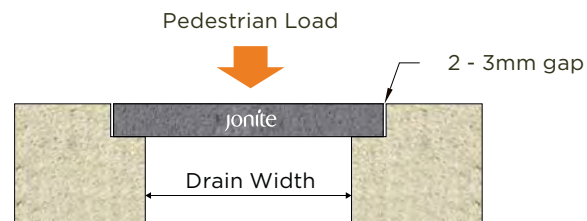

Install directly on flat & level concrete drains and tiles.

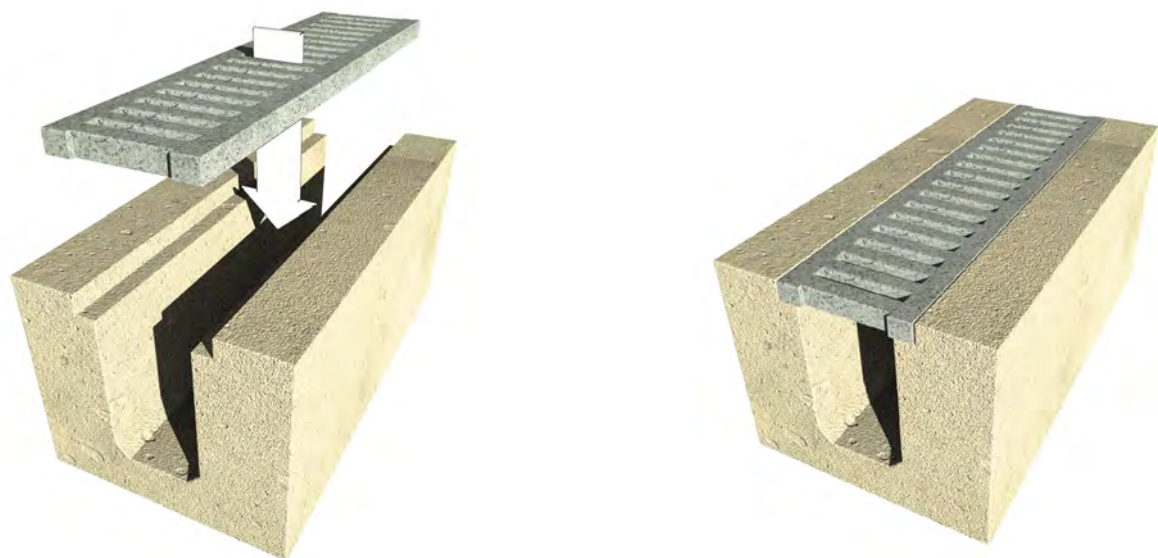

2 LIGHT-DUTY GRATES WITH L-STEEL ANGLES

For specific applications, especially with custom curve grates, it might be easier for installers to use L-Steel angles to ensure level flatness. These are still strictly for pedestrian applications only.

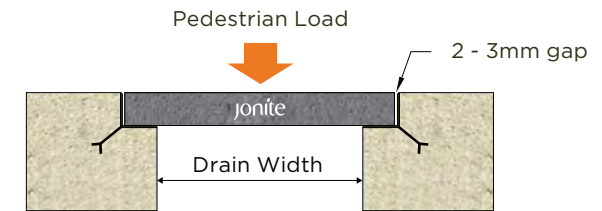

Install with L-steel angles and fishtails.

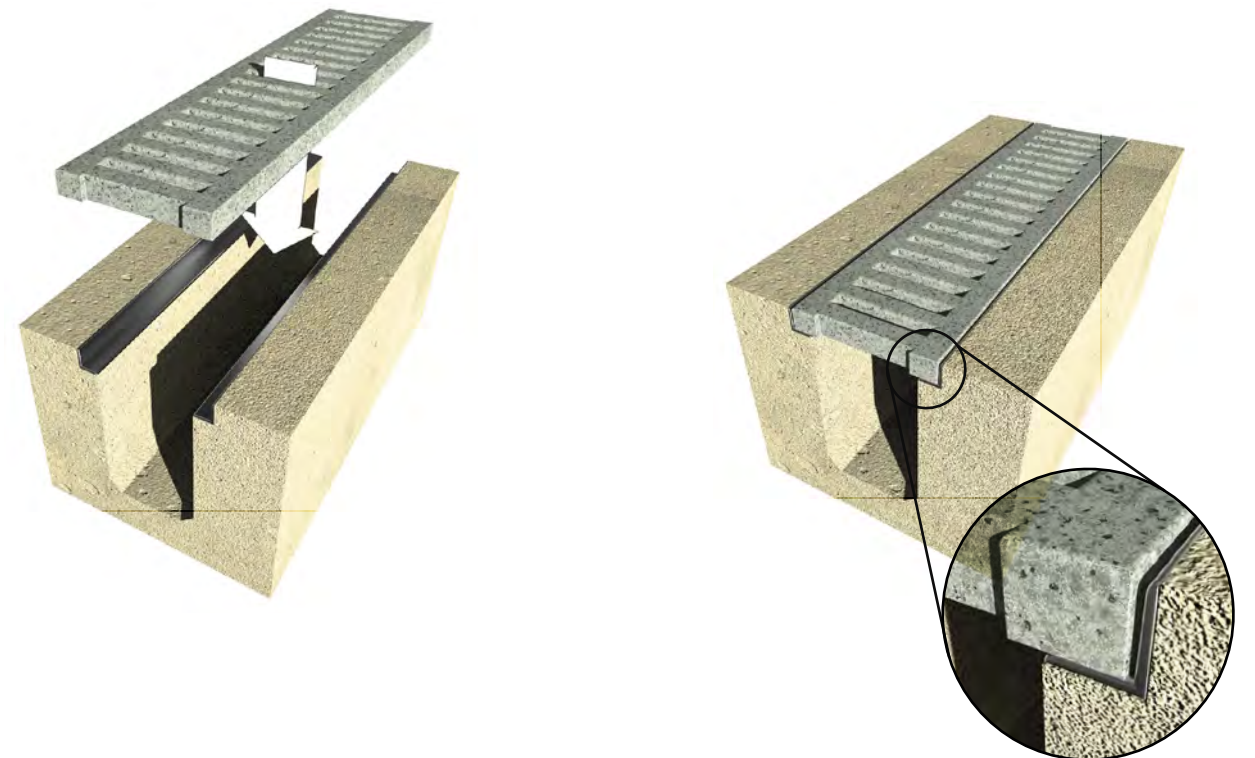

L-steel angles ease the leveling process during installation.

3
**HEAVY-DUTY GRATES
WITH JONITE L-TRIMMERS™**

Trench grates for vehicular application (125KN - 400KN), must be flatly installed on a 90-degree edge to ensure maximum performance. Jonite L-Trimmers™ provides this with a bonus of aesthetic flair.

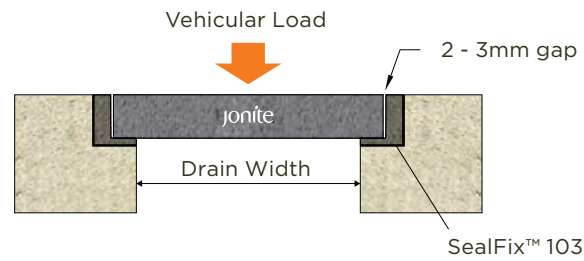

Jonite L-Trimmers™ is installed using dry fixing with SealFix™ 103 (epoxy mortar).

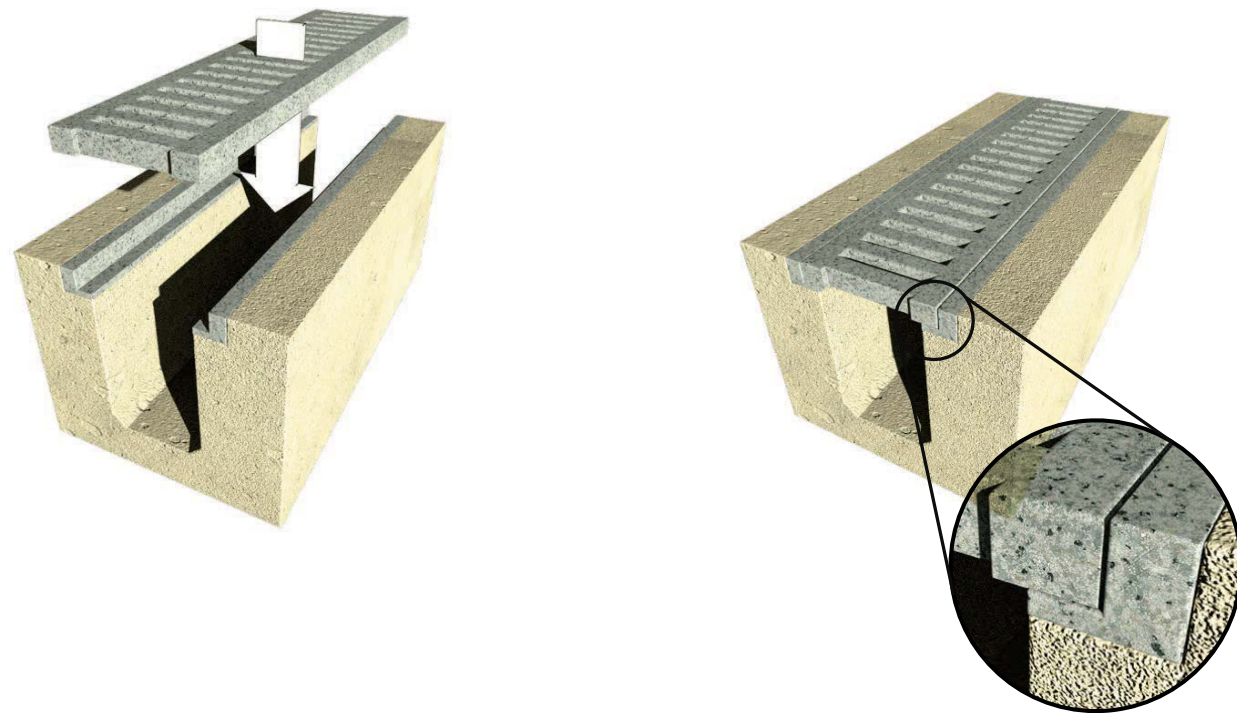

Jonite L-Trimmers™ provides a clean and aesthetically appealing installation.

4
**HEAVY-DUTY GRATES
WITH INVERTED L-STEEL
ANGLES**

For a more cost-effective alternative, heavy-duty trench grates can be installed on a flat surface with a 90-degree edge by inverting an L-steel angle and welding a flat bar to the side.

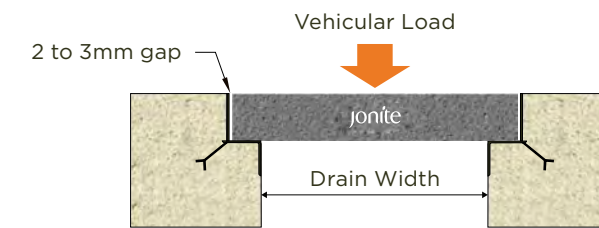

An inverted or a fabricated L-steel angle allows a 90-degree edge seating, which prevents cracks caused by point loading.

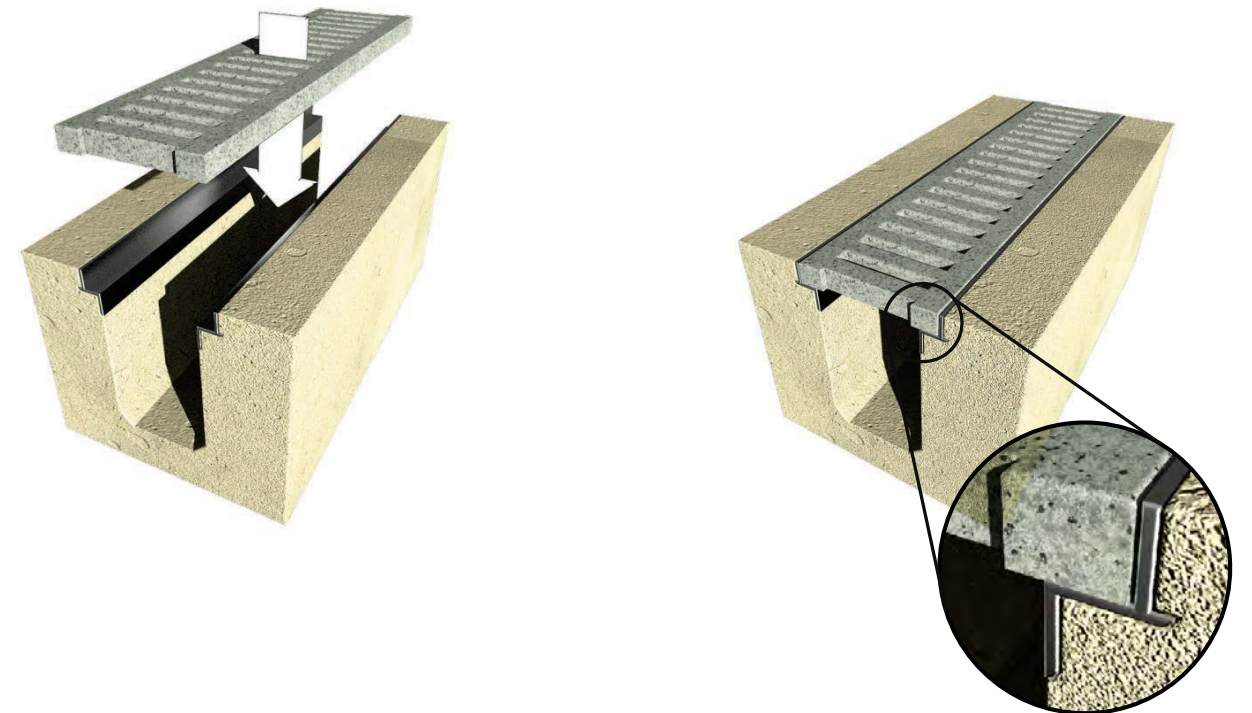

A 90-degree seating edge can be obtained in a variety of ways using L-steel angles.

5
**GRATES WITH COMPATIBLE
DRAIN CHANNELS**

Selected Jonite trench grate models are designed to fit perfectly into specifically manufactured drain channels. Custom options can also be available upon request.

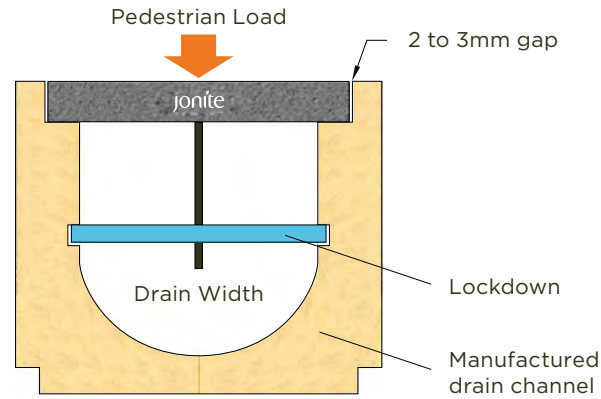

Install directly on the compatible drain channels. Some models can be bolted down with lockdown features.

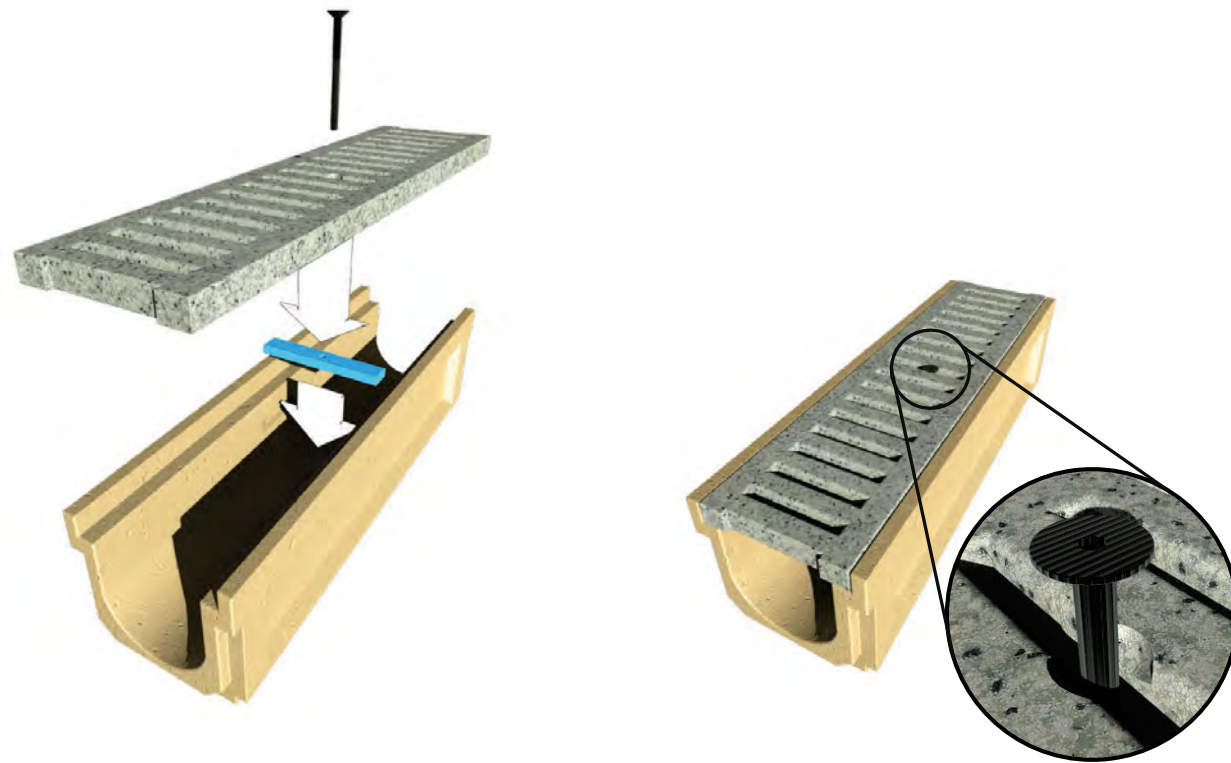

After placing the lockdown plate, a countersunk bolt is then bolted in to secure.

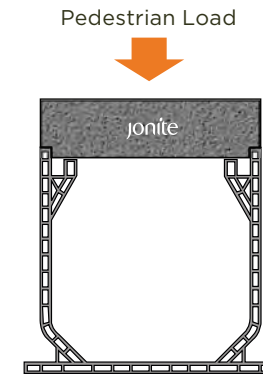

Jonite Mini Grate™ being installed on compatible channels. Grates come with recessed grooves for a snug snap and fit.

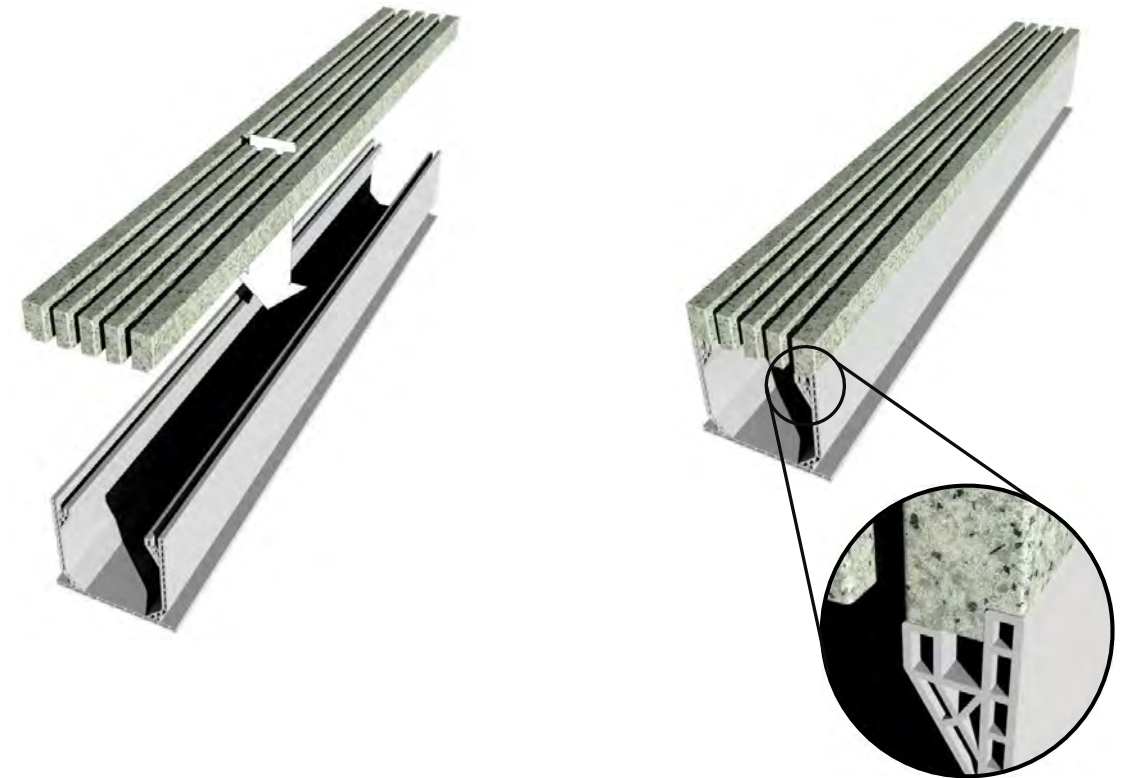

Jonite Mini Grate™ is specially cut to fit snugly onto the channels, providing a clean and edgeless aesthetic.

Curve Grates

Installation

All Jonite curve grates can be customized into any radius requested. However, there are three recommended methods, usually depending on the application and installation of the straight standard grates.

Jonite can either provide the Curve Templates™ for installers to check and guide the radius of the formwork or provide a full-scale CAD drawing of the template.

ON LEVEL CONCRETE

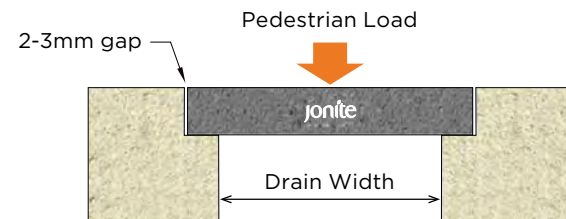

WITH L-STEEL ANGLES

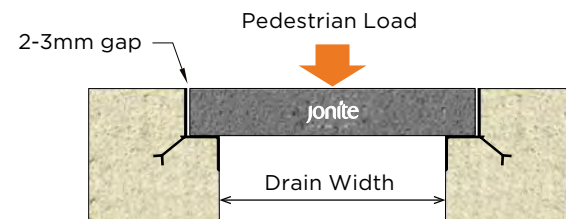

WITH JONITE L-TRIMMERS™

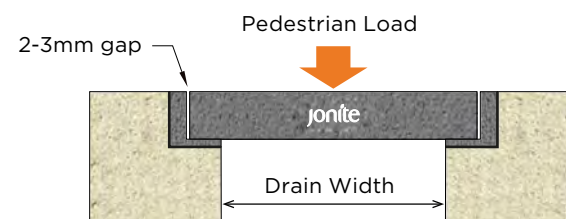

1 ON LEVEL CONCRETE

This method uses L-steel angles cold-rolled to the required radii with considerations such as screeding, the thickness of form-ply, and allowance of the internal drains.

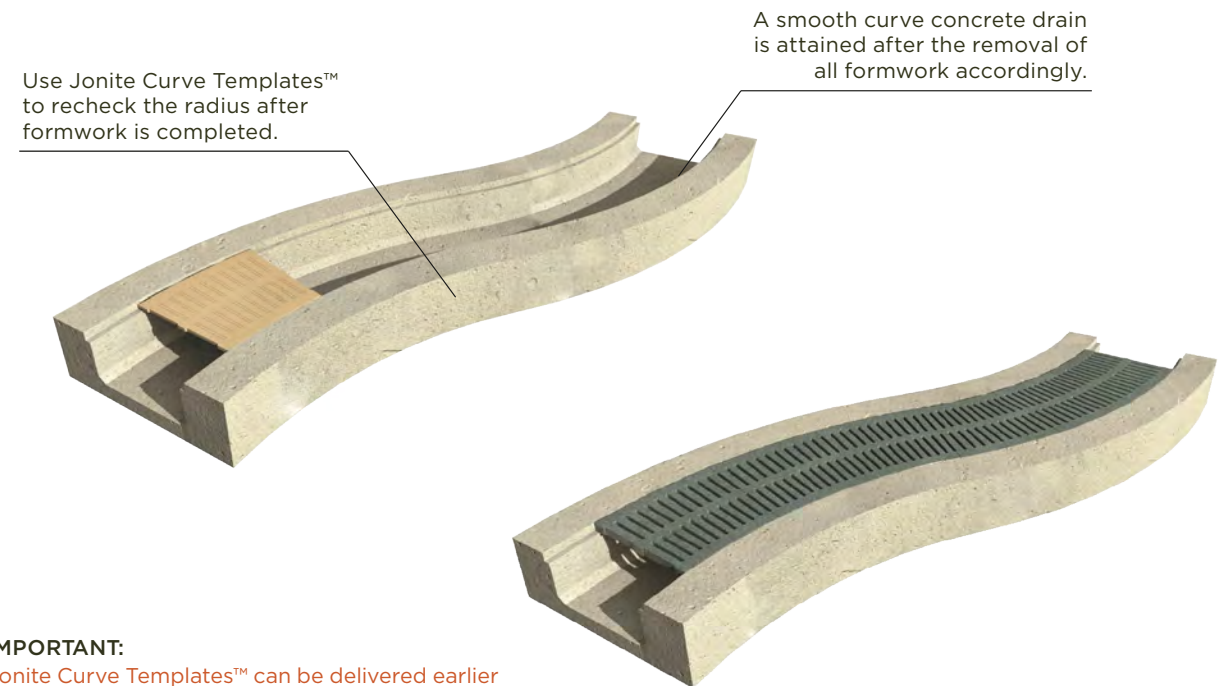
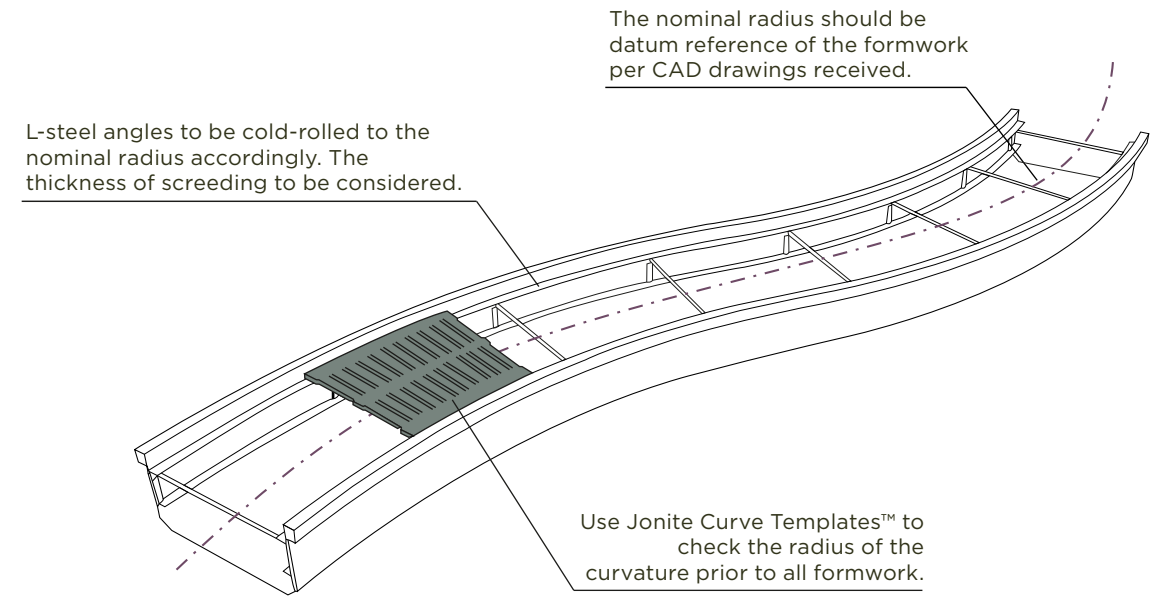

IMPORTANT:
Jonite Curve Templates™ can be delivered earlier for checking of the drain curvature.

2
WITH L-STEEL
ANGLES

This method uses L-steel angles to be cold-rolled to the nominal radii accordingly. The entire metal frame in curvature will be positioned and mounted firmly over the timber formwork. This formwork must also be in line with the curve of the metal framework accordingly.

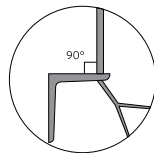
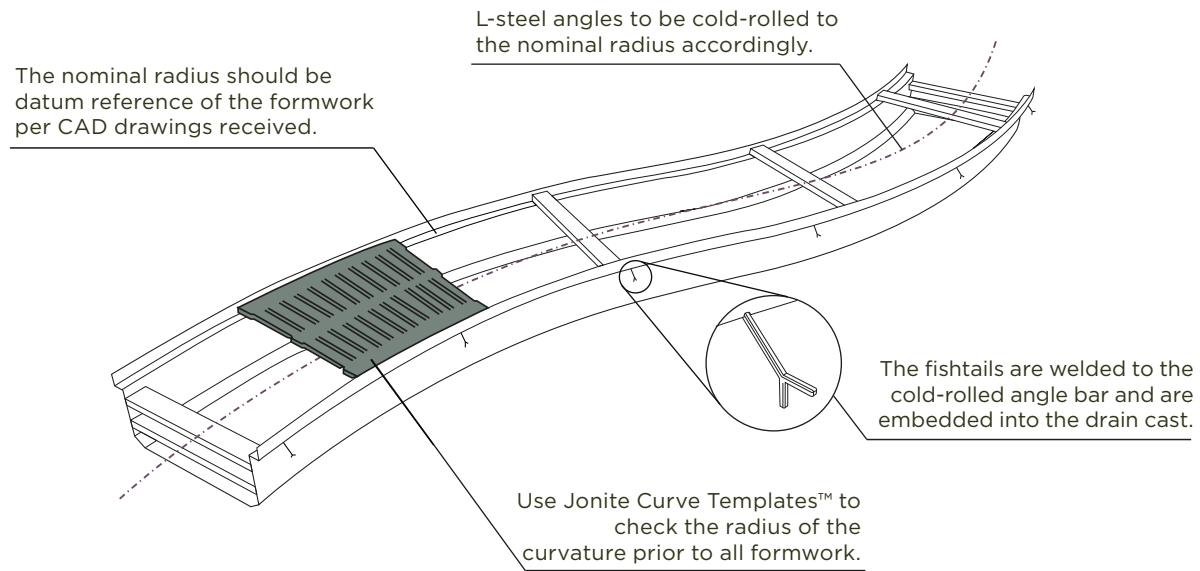

IMPORTANT: A 90-degree edge seating as shown must be ensured for vehicular application.

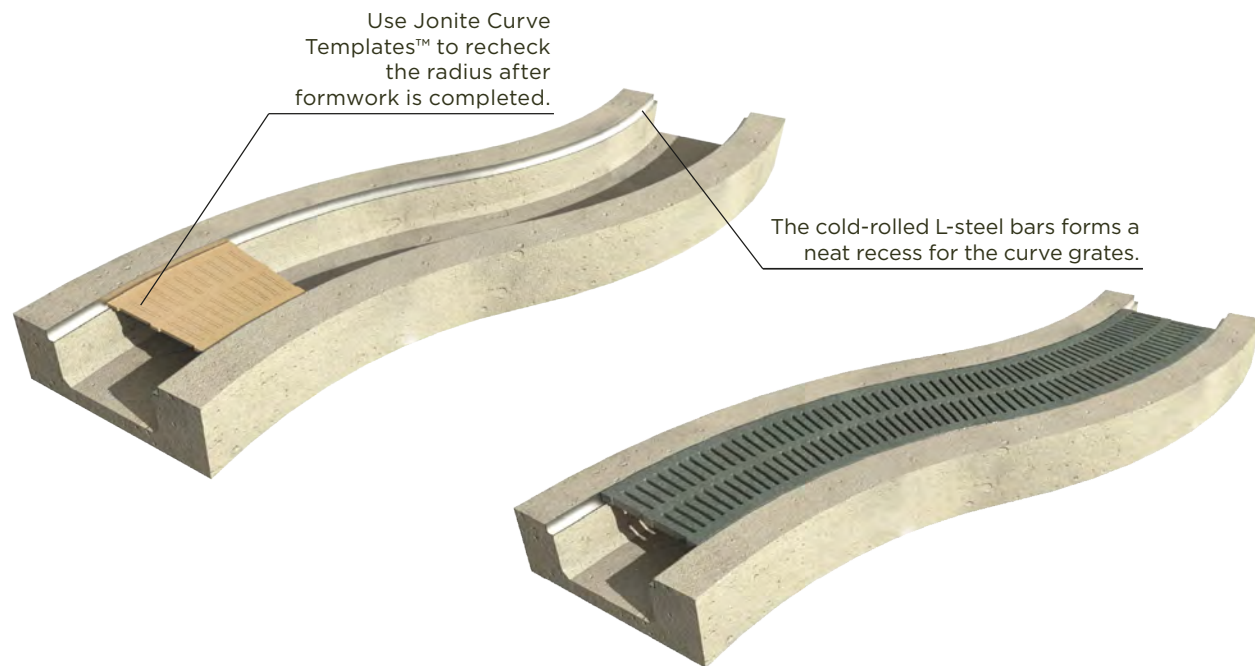

3
WITH JONITE
L-TRIMMERS™

This method uses Jonite L-Trimmers™ as the shoulder seating for the curve grates. This method can be used for any application. The curve L-Trimmers come in a set of two sections, the inner and the outer curvature. They are accurately produced to the nominal radius accordingly.

The vertical curve drain is cast similarly to the level concrete without the recessed shoulder seating provision. The curve drains will then be installed with the L-Trimmers using dry fixing with SealFix™ 103 (epoxy mortar).

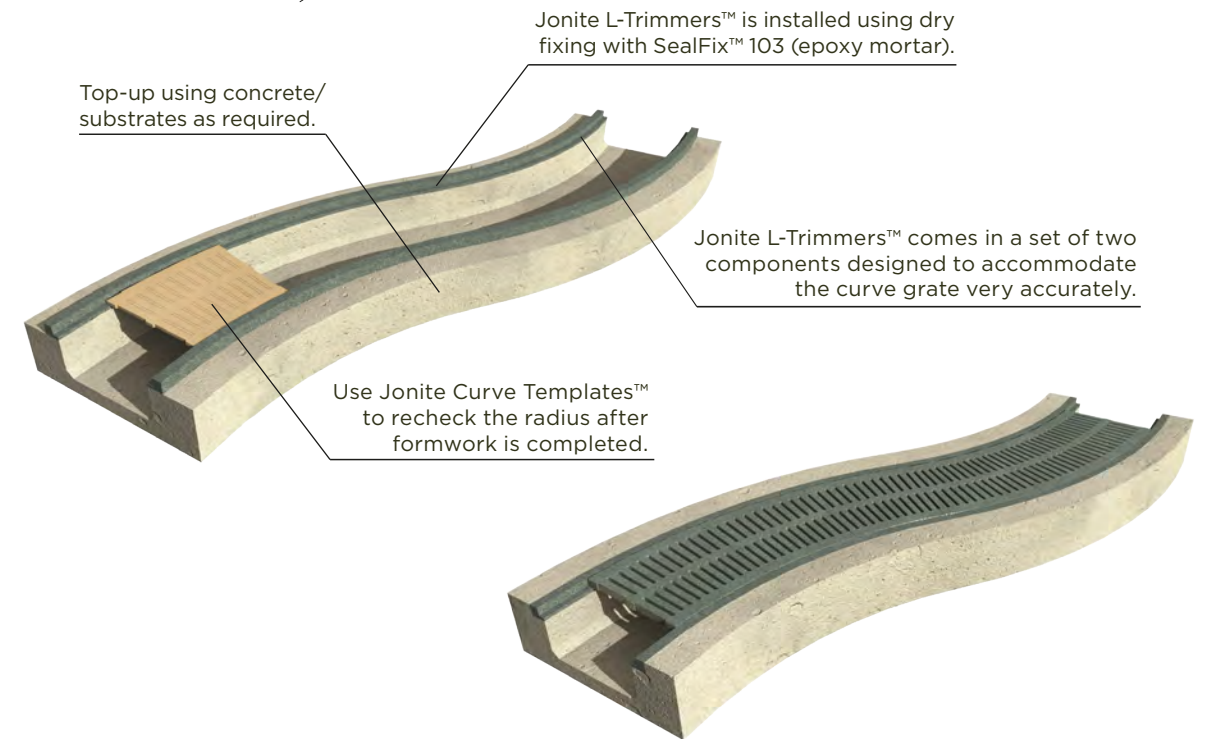
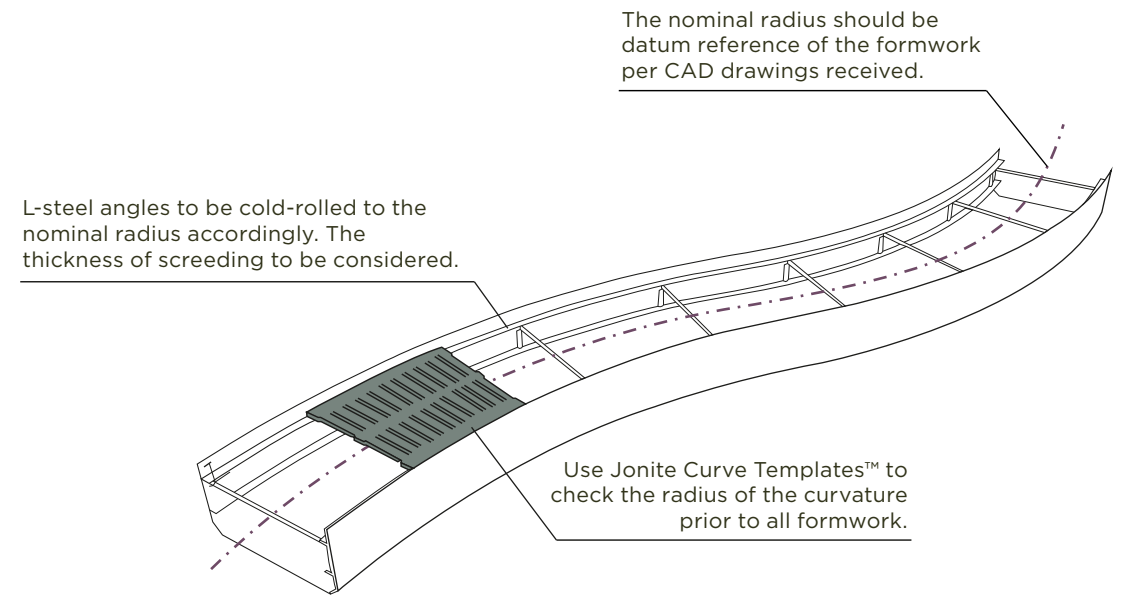

Grate Tiles™ Installation

Jonite Grate Tiles™ are standard non-perforated solid slabs that have the same material composition and colour as Jonite grates. They are mainly used when a drain encounters an irregular joint or to fill an odd end of a drain.

Light-duty (pedestrian-rated) models can be cut on-site by the installer, as shown below. Heavy-duty (vehicular-rated) models must be factory fabricated according to templates or full-scale CAD drawings provided by the installer.

1 LIGHT-DUTY GRATE TILES™

Light-Duty Grate Tiles™ are not reinforced and can be easily cut on-site with a circular saw. The shape and dimension required can be easily traced and cut on the Grate Tile™ as desired. It is important to note that the minimum length of the Grate Tile™ being supported must be at least 50mm.

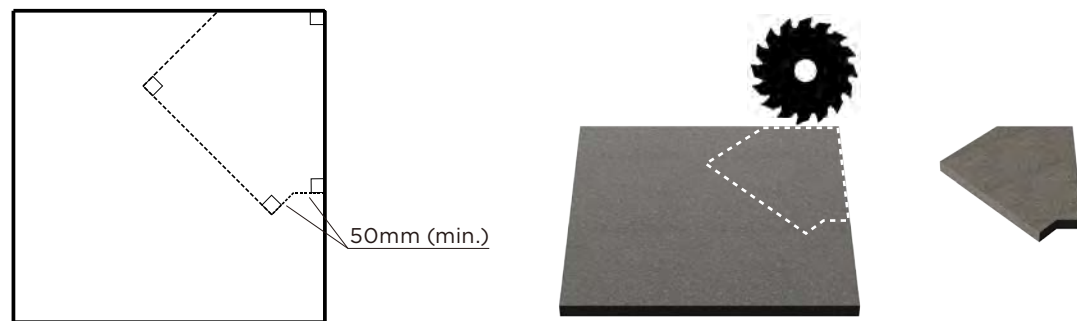

IMPORTANT: Supported length of the Grate Tile™ must be at least 50mm

1 Trace the desired shape and dimension & cut accordingly with a circular saw.

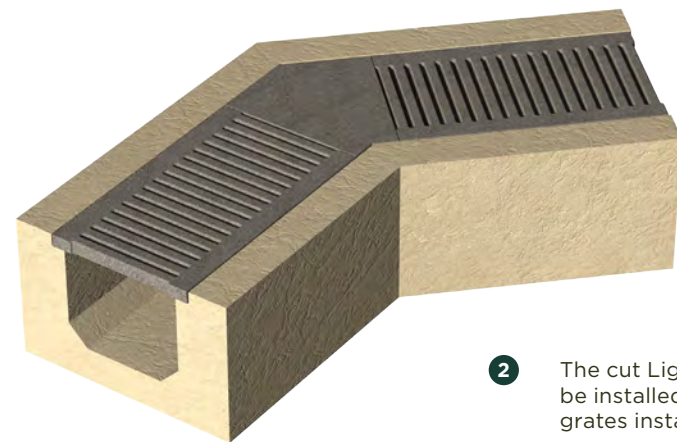

2 The cut Light-Duty Grate Tile™ can be installed together with the trench grates installation.

2 HEAVY-DUTY GRATE TILES™

Heavy-Duty Grate Tiles™ cannot be cut on-site due to their thick heavy reinforcements within. The shape and dimension required must be accurately traced onto a piece of cardboard or plywood. Alternatively, the installer can determine them onto a full-scale CAD drawing. The shape and reinforcements of the Grate Tiles™ will then be fabricated according to the templates or drawings provided.

1 Trace the desired shape and dimension accurately on to a wooden template or full-scale drawing.

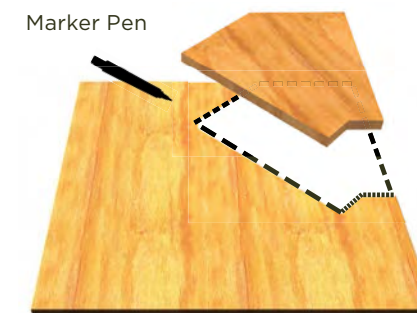
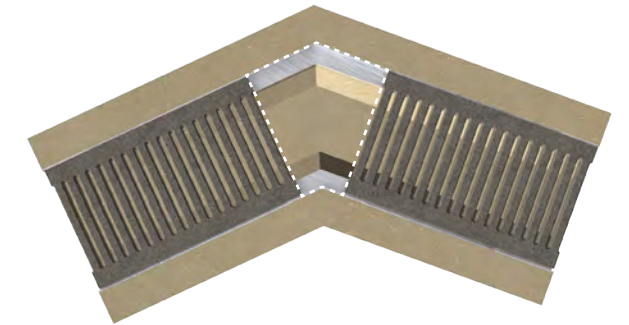

2 Send cut templates or drawings to Jonite for fabrication.

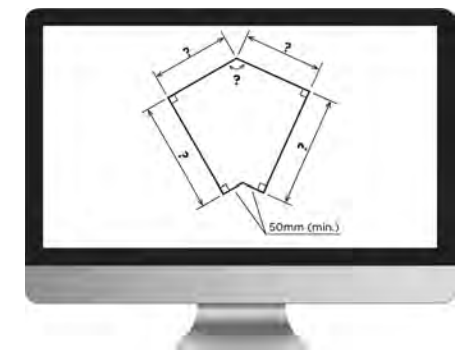

3 The cut Heavy-Duty Grate Tile™ should only be installed after the trench grates installation.

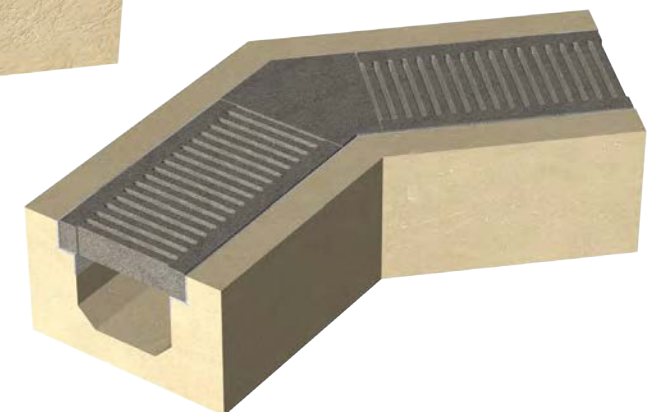
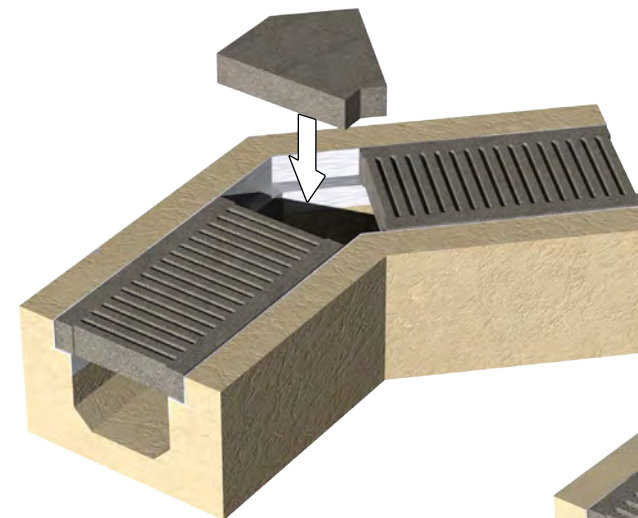

Tree Grate

Installation

For most tree grates to perform optimally, sufficient rooting space must be provided for the tree. The amount of rooting space almost entirely depends on the species of tree, which would determine the height of the concrete base supporting the tree grate.

For larger tree grates, a support frame is critical to ensure the tensile strength required. Drawings of support frames can be provided should the frames be fabricated locally.

1 SMALL TREE GRATES

For small Jonite tree grates, which consist of two panels or less, the tree grates can be supported on the level concrete base directly.

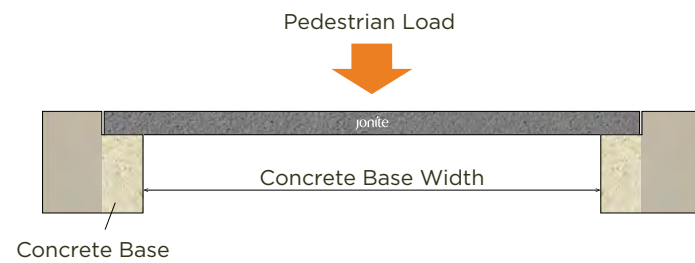

Install directly on level concrete base.

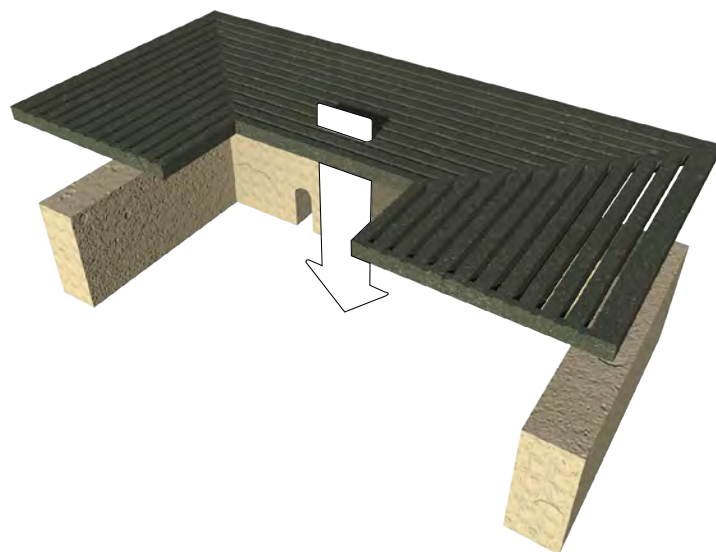

2 LARGE TREE GRATES

Large Jonite tree grates are usually more than 1200mm in total length and consist of more than two panels, thus requiring the need for a supporting frame. The tree grates must be flatly resting across the supporting frame, which must be securely bolted together.

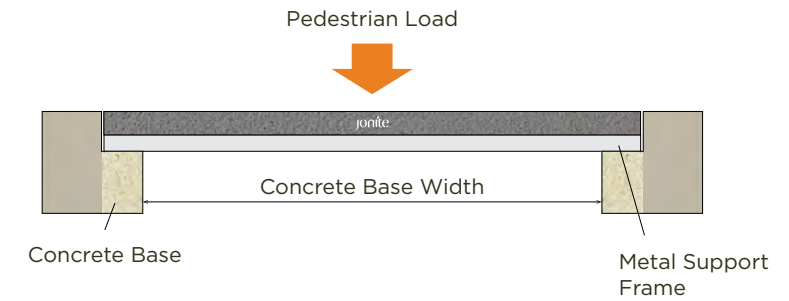

The metal supporting frames will be rested directly on a concrete base.

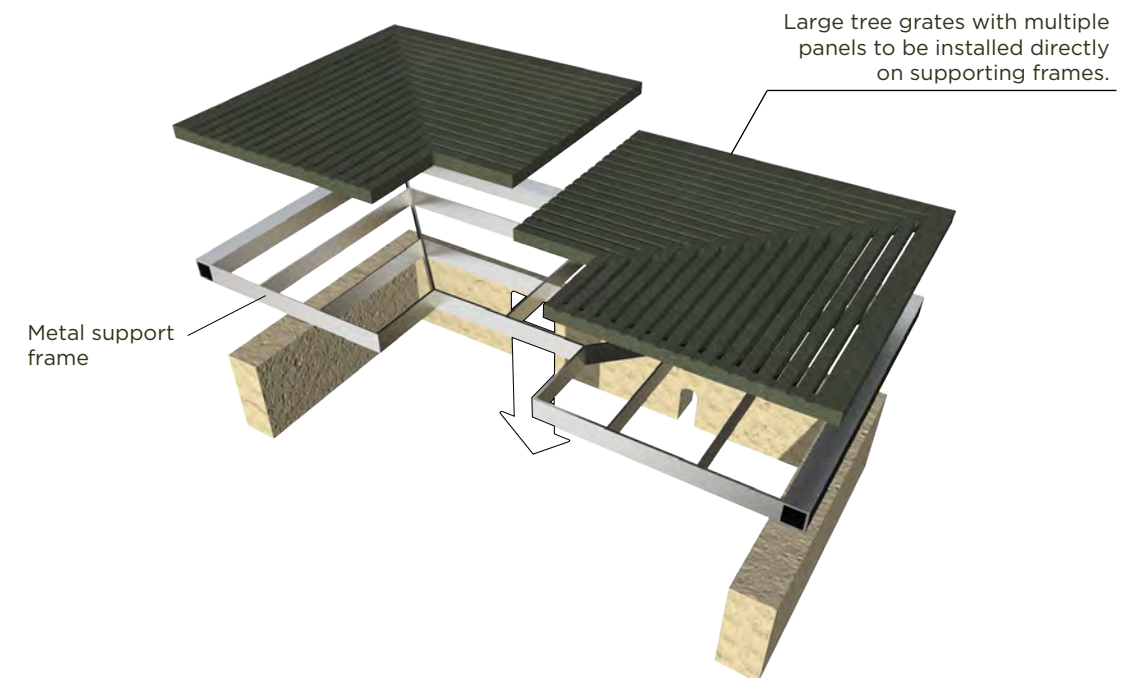

Ensure that the tree grates are installed flat and level for optimal performance.

3
**SMALL TREE GRATES
WITH LOCKDOWNS**

For small Jonite tree grates with lockdowns, they must be installed with a frame so that the tightening bolts can be securely fastened through the frames.

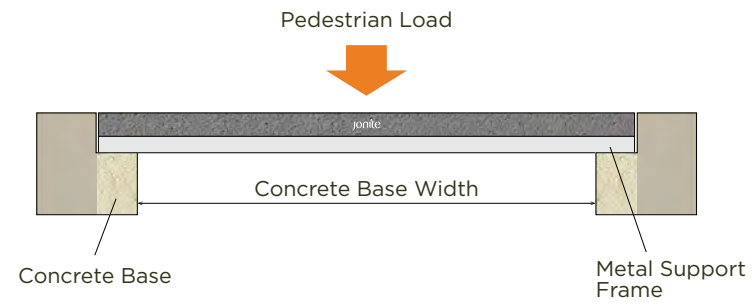

4
**LARGE TREE GRATES
WITH LOCKDOWNS**

As the supporting frames may arrive in sizable multiple panels, it is crucial for the larger Jonite tree grates with lockdowns to be aligned with the support frames before securely fastening the bolts. Once secured and aligned, always check to ensure if the tree grate panels are flatly resting on the frames, especially across the perimeter.

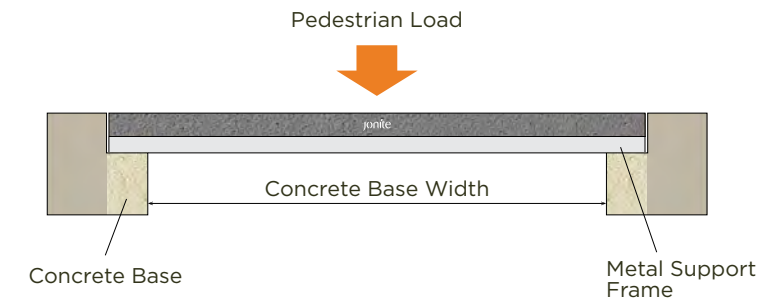

Always ensure the multiple panels are flat, level and aligned before locking down.

Tree grates to be bolted down through the support frames.

Small tree grates to be installed directly on supporting frames, which will be rested directly on a concrete base.

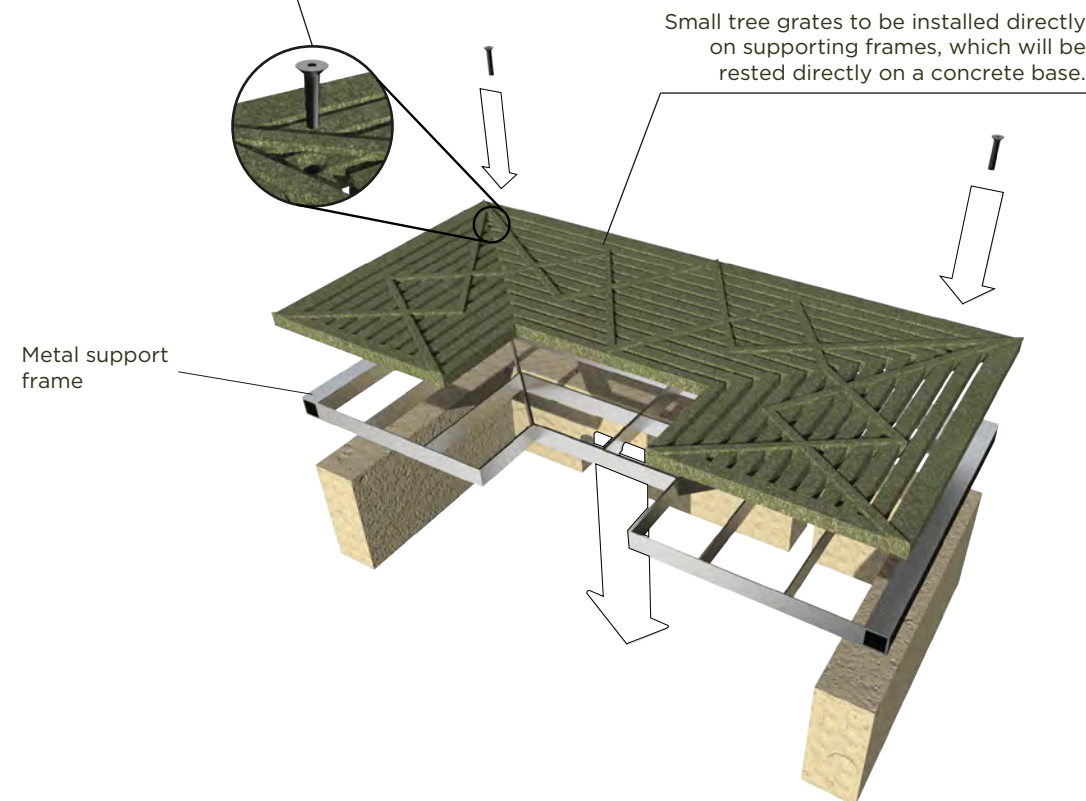

Large tree grates with multiple panels to be installed directly on supporting frames, which will be rested directly on a concrete base.

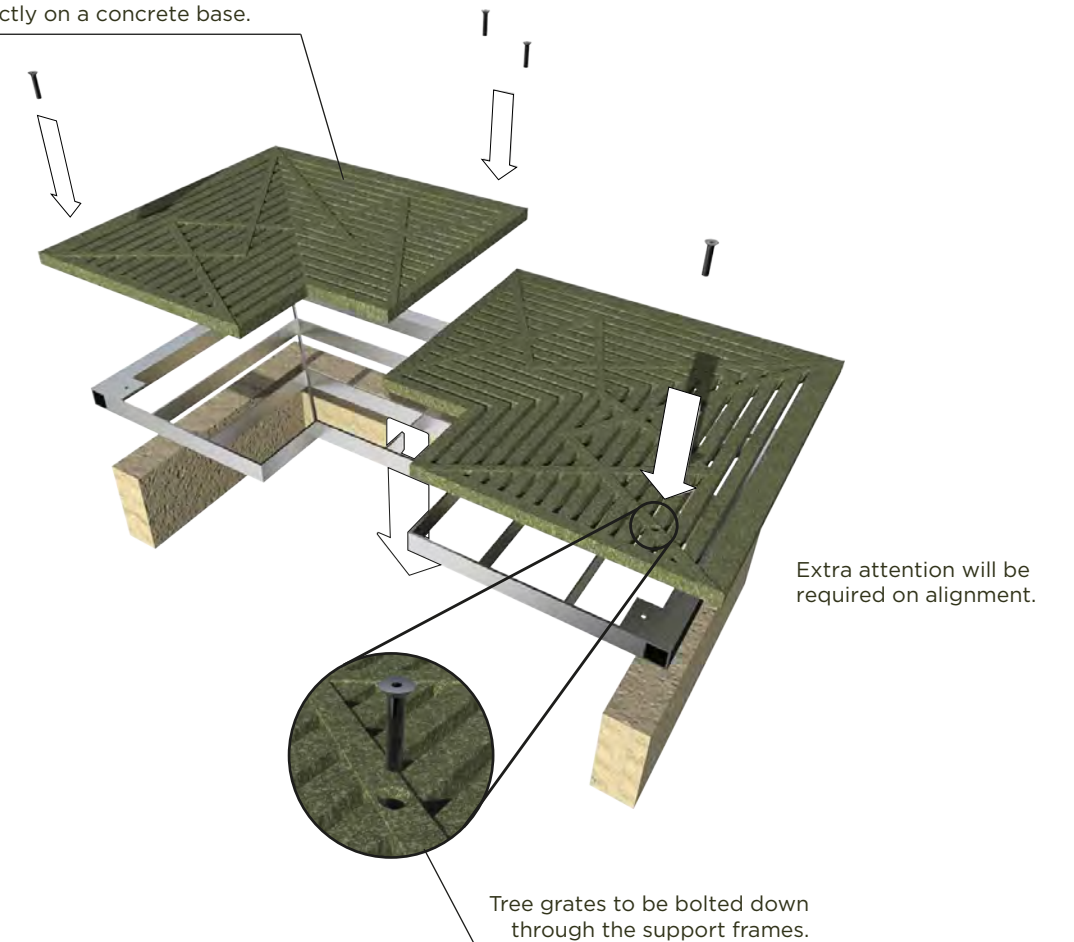

Banco™ Installation

The BANCO street benches come in two models, the BR (with backrests) and SS (without backrests). Like most street benches, the BANCO models are designed to be installed outdoors permanently. It is essential that the site is well prepared prior to any bench installation.

Preparation

- 1 Unpack all the components and arrange them accordingly, as shown in illustrations below.
- 2 Prepare all necessary tools in advance.

1 BENCH PEDESTALS & TOP-ARC PLACEMENT

- 1 Assemble all the bench pedestals with Top-Arc first, followed by Lower-Arc, and the Centre-Arc.

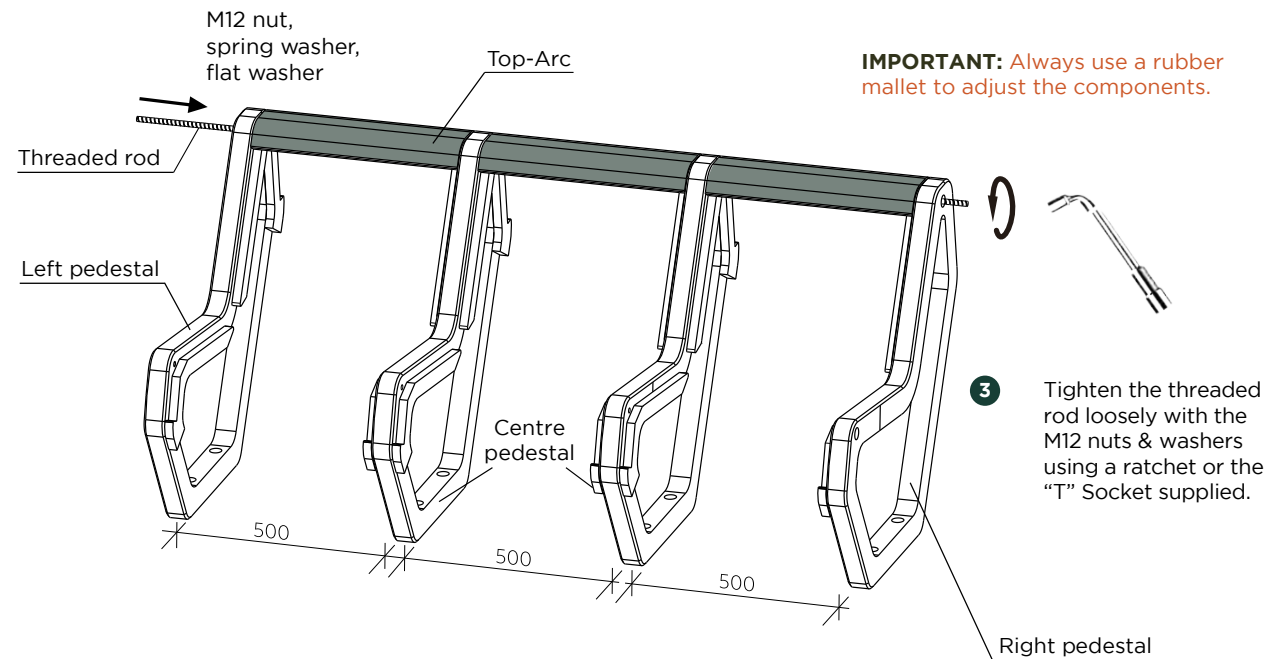

- 2 Place the left pedestal and centre pedestal upright about 500mm away from each other. Hold the pedestals with the Top-Arc and pull through the threaded rod slowly.

- 3 Tighten the threaded rod loosely with the M12 nuts & washers using a ratchet or the "T" Socket supplied.

2 LOWER-ARC PLACEMENT

- 4 Place the Lower-Arc in position and pull through the next threaded rod as previously done on the Top-Arc.

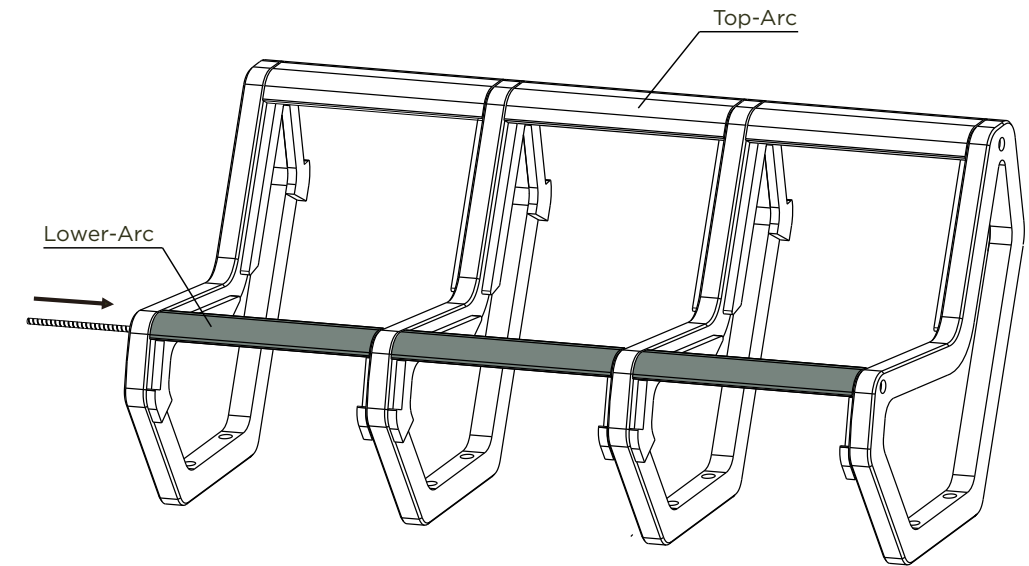

- 5 Tighten the threaded rods loosely with the M12 nuts, spring washers, and flat washers to square up the entire skeleton unit as required.

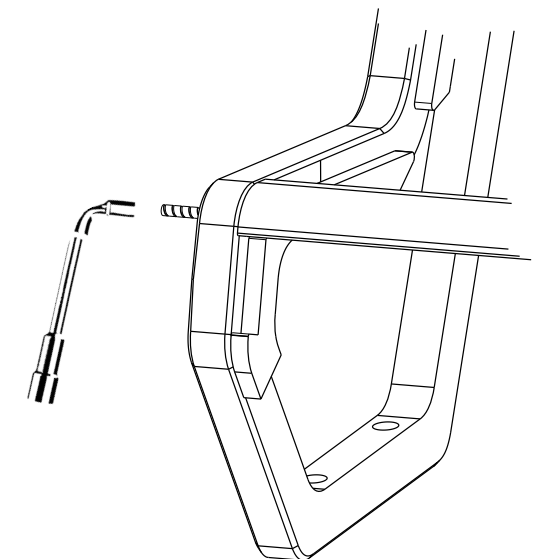

3 CENTRE-ARC PLACEMENT & POSITIONING

- 6 Place all the Centre-Arc components in position over the placed pedestals.

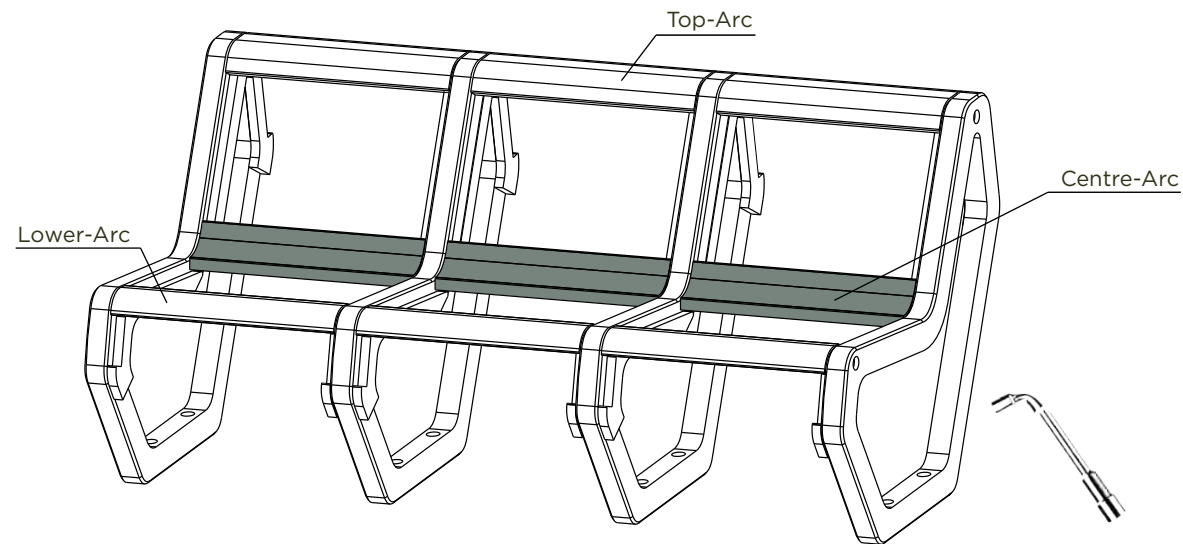

- 7 Once their alignment is fixed, tighten the threaded rods to square-up the entire skeleton unit. Doing this determines the floor mounting position.

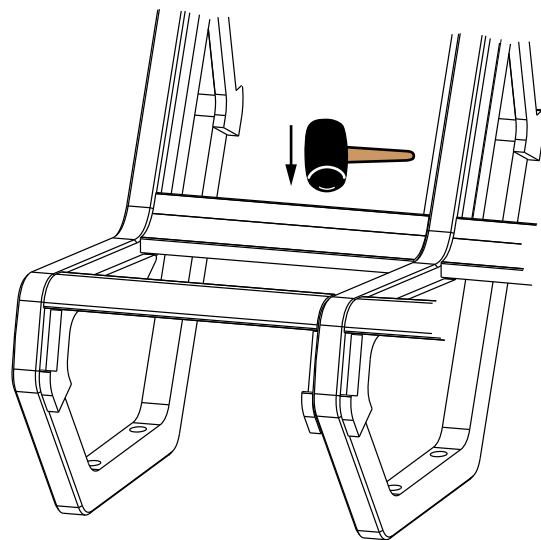

IMPORTANT: Always use the rubber mallet to reposition the components before tightening.

4 DRILL-POINT MARKING

- 8 Carry the skeleton unit by slowly sliding it to the required position. Do not lift the skeleton unit high as that may damage the components.

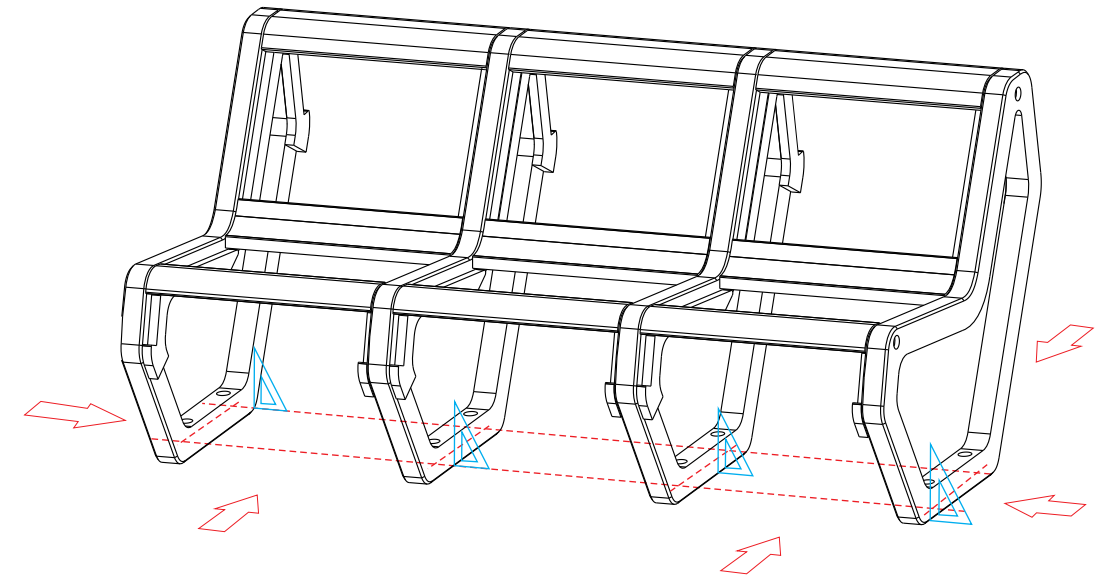

IMPORTANT: Use a set square or a try square to check the perpendicularity of all the pedestals.

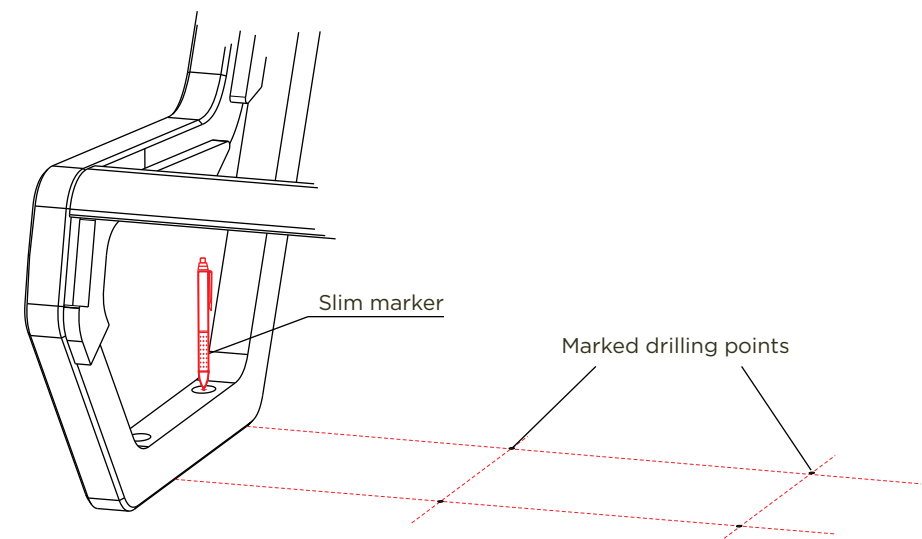

- 9 Once the skeleton unit is in position, tighten all the threaded rods. Use a slim marker to mark out the drilling points as required.

5 DRILLING ON DRILL POINTS

- 10 Shift the skeleton away from the drilling points so that it does not get in the way.

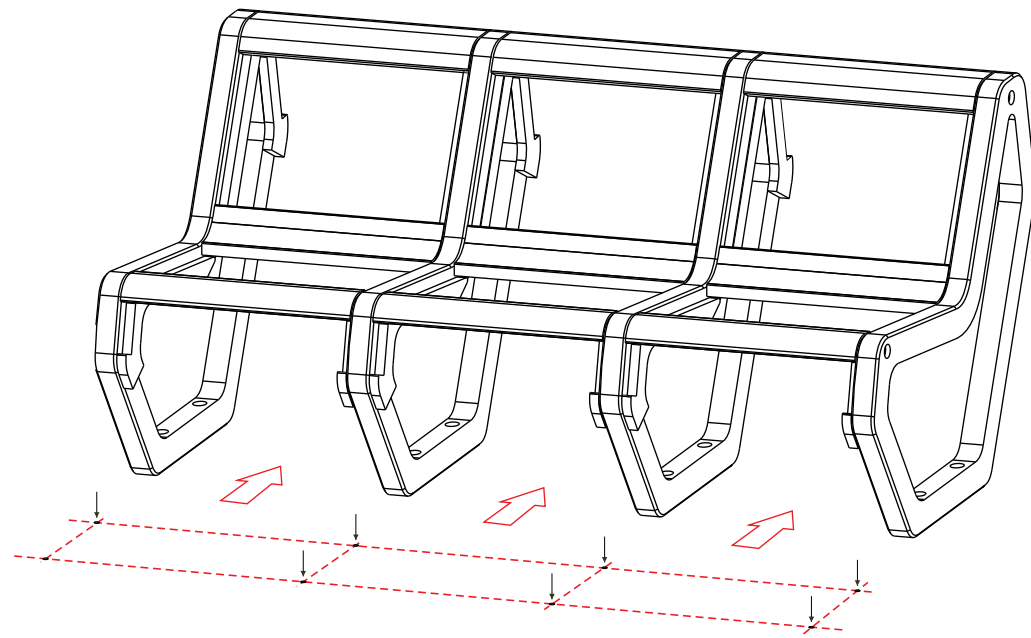

- 11 Set the concrete hand-drill with the right drilling bit for an M8 socket and proceed to drill the drill-points with the depth not exceeding 30mm (length of M8 socket).

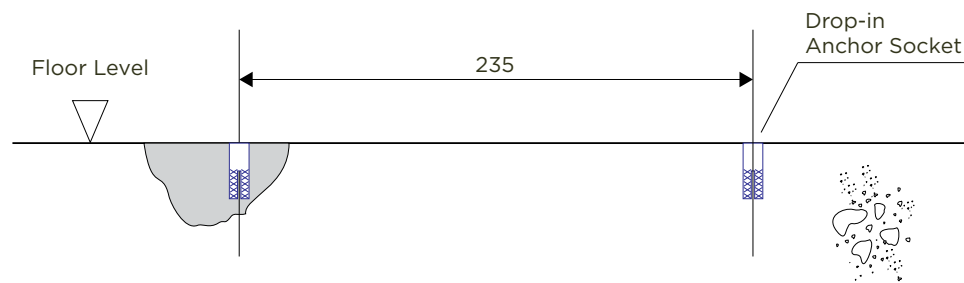

IMPORTANT: Should there be a mistake in drilling, enlarge the hole and fill it with SealFix™ provided. Then place the drop-in anchor socket in the right position. The curing time is 24 hours.

6 TIGHTENING BOLTS

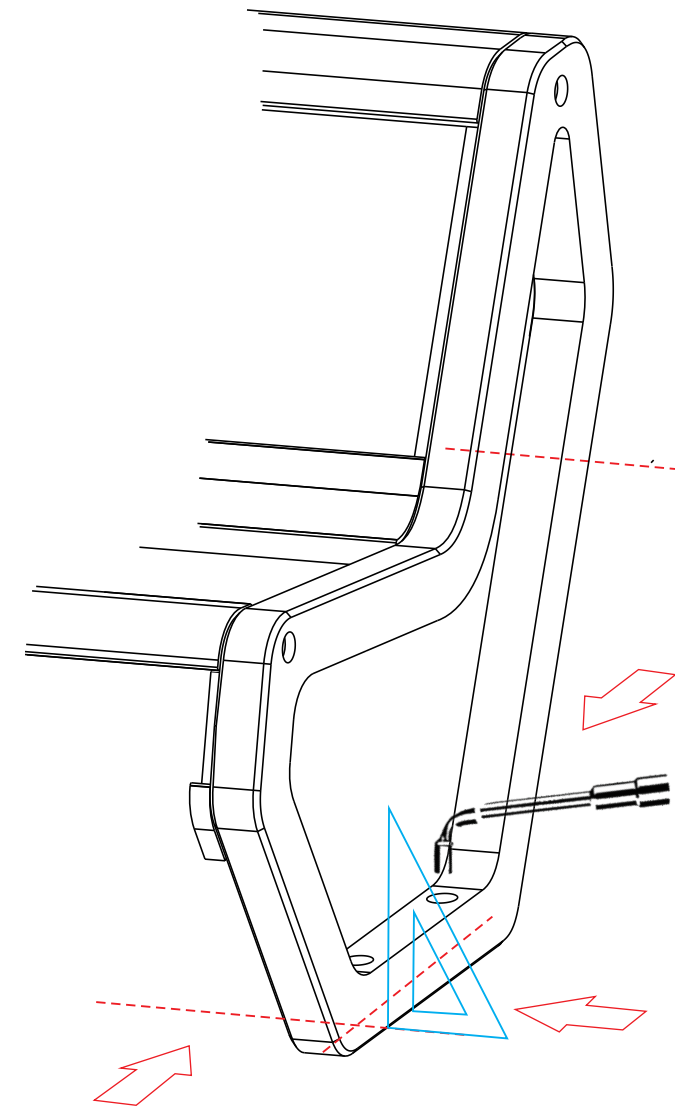

- 12 After cleaning the dust from the drilling, shift the skeleton unit back to the position where the points were drilled.

- 13 Insert the M8 x 65mm bolts with the flat and spring washers into the base of pedestals accordingly.

- 14 Fasten all the bolts as the skeleton unit gets straightened. Do not fasten the bolts fully as the unit gets aligned.

7 GRATES ALIGNMENT

- 15 Place all the grates into position accordingly. Adjust the entire bench by tightening and loosening the threaded rods, M12 nuts, and the anchoring bolts for squaring.

IMPORTANT: Do not apply the SealFix™ yet.

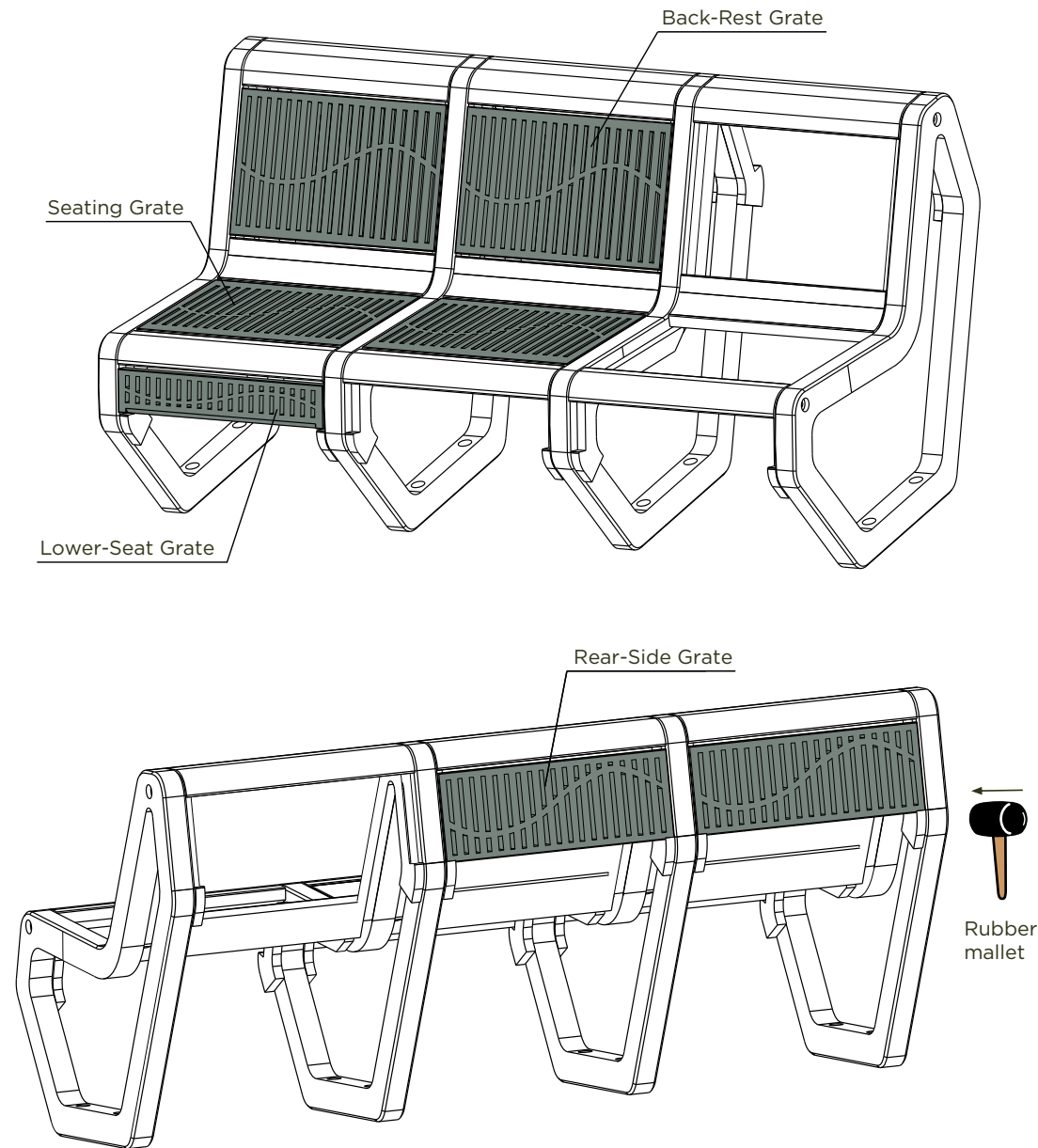

- 16 Check that all the components are properly aligned by tapping them with the rubber mallet constantly.

8 GRATES INSTALLATION

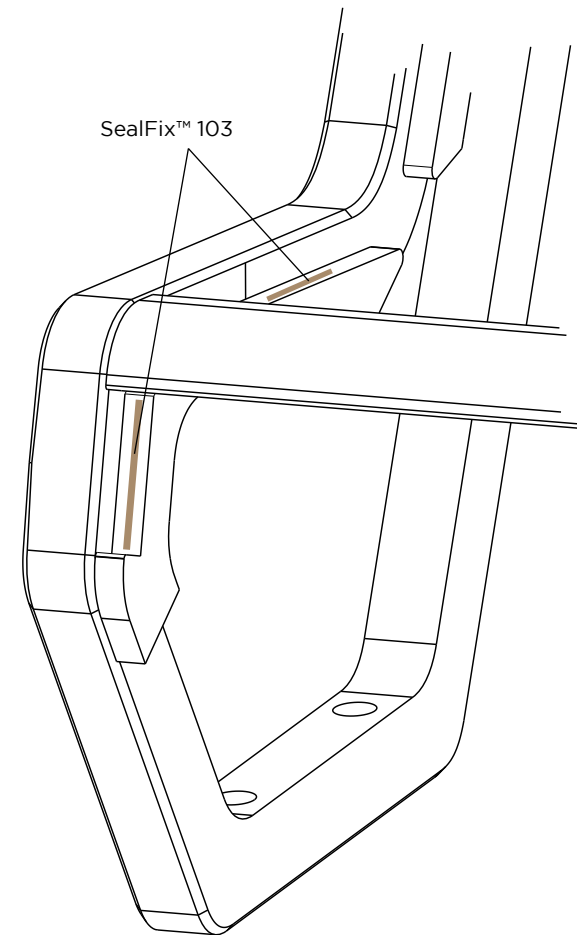

- 17 Once all the components are squared and positioned, remove the grates one at a time and apply SealFix™ 103 on the contact areas.



- 18 Tighten all fasteners after all the grates are fully installed. The adhesive will be secured with a strong bond after 24 hours and fully cured in a week.

9
INSERTING CAPS

19 Insert the caps to the respective bolt and fastening holes. Slight grinding may be required for caps to flush. Use SealFix™ to seal up.

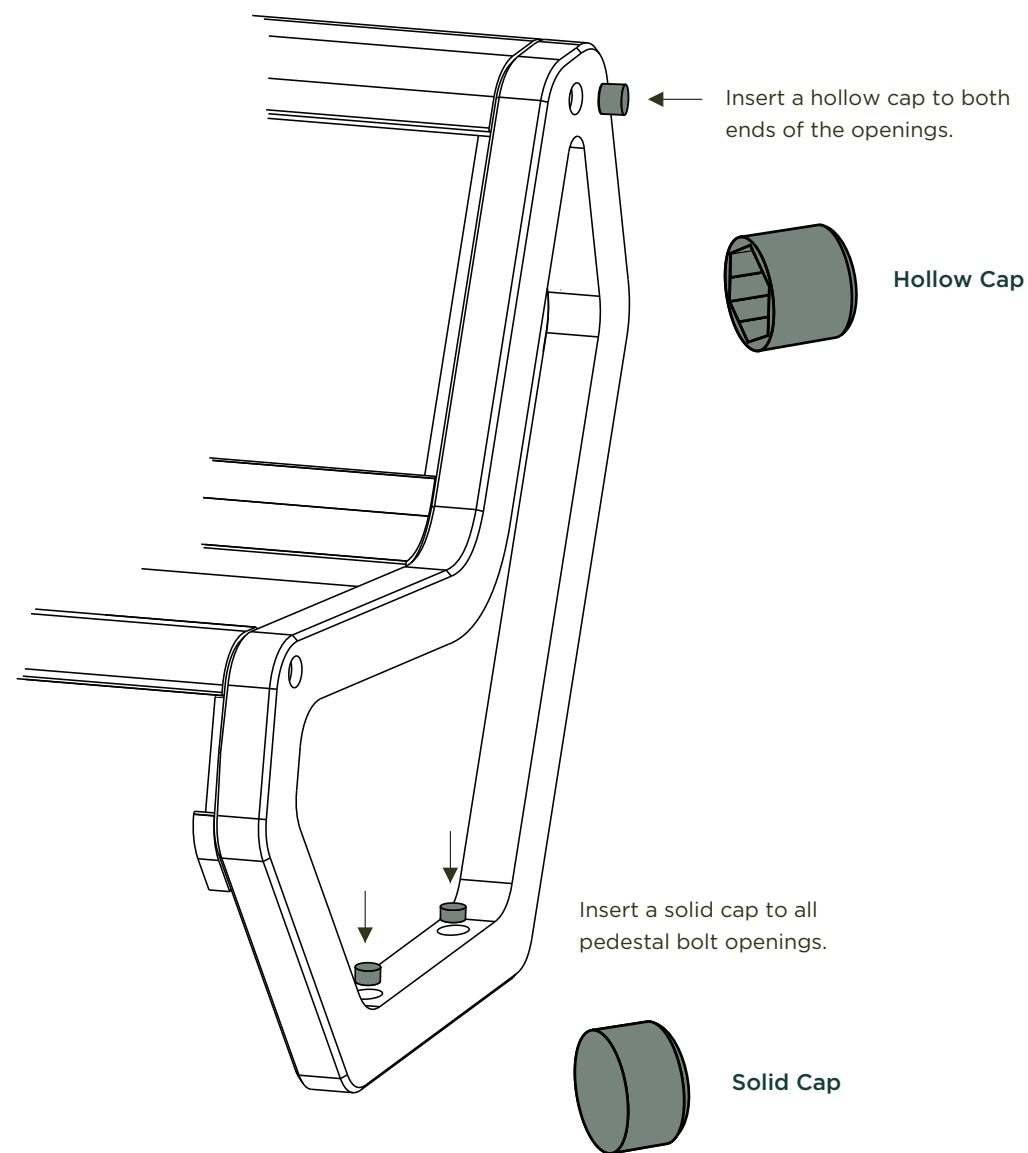

10
COMPLETION OF BANCO INSTALLATION

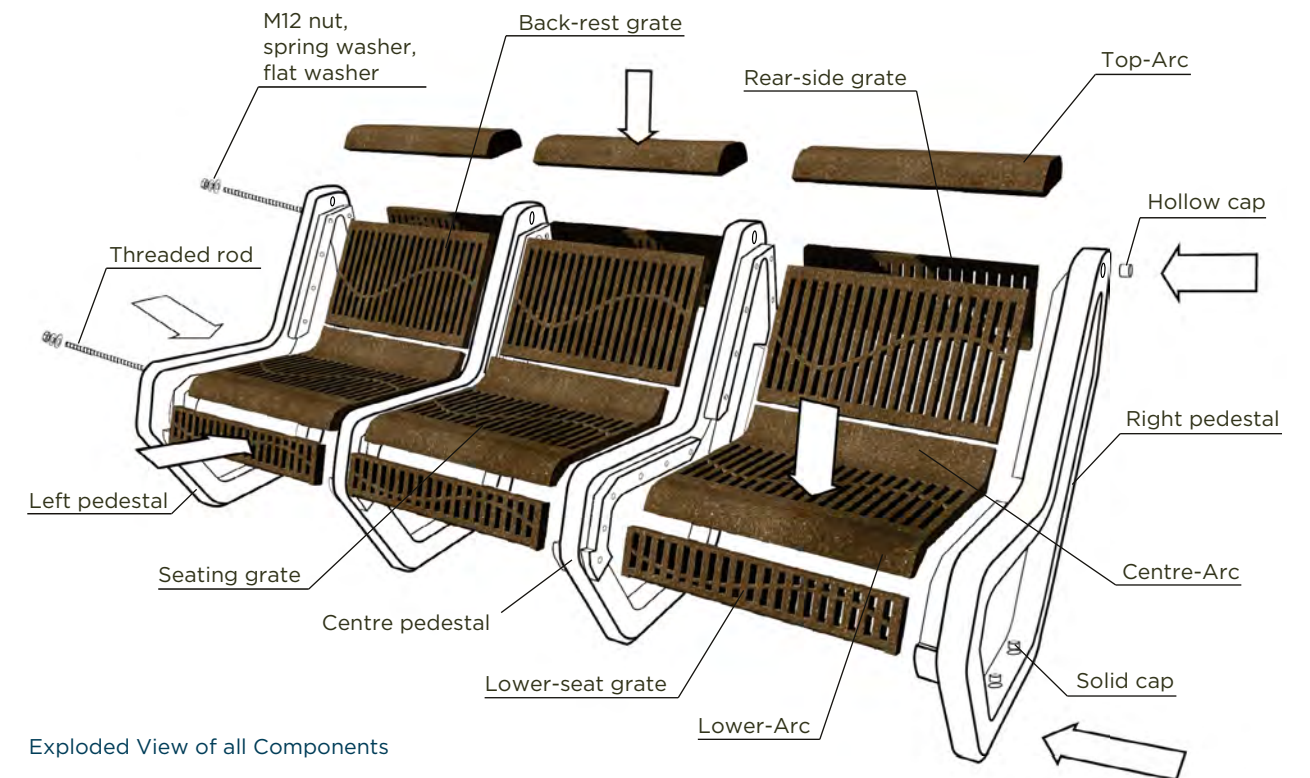

BR 300-3 SEATER

Pool Grates

Installation

Jonite pool grates are installed very similar to how light-duty trench grates are installed, only directly on level concrete, or on trimmers for added aesthetics and flatness. It is important to note that, however, although they are very similar, the condition of the site must be kept pristine to prevent any potential injuries for bare feet.

1 LIGHT-DUTY POOL GRATES ON LEVEL CONCRETE

Jonite pool grates, which are strictly for pedestrian application (6KN), can be installed directly on level concrete as long as they are installed flatly with no visible rocking.

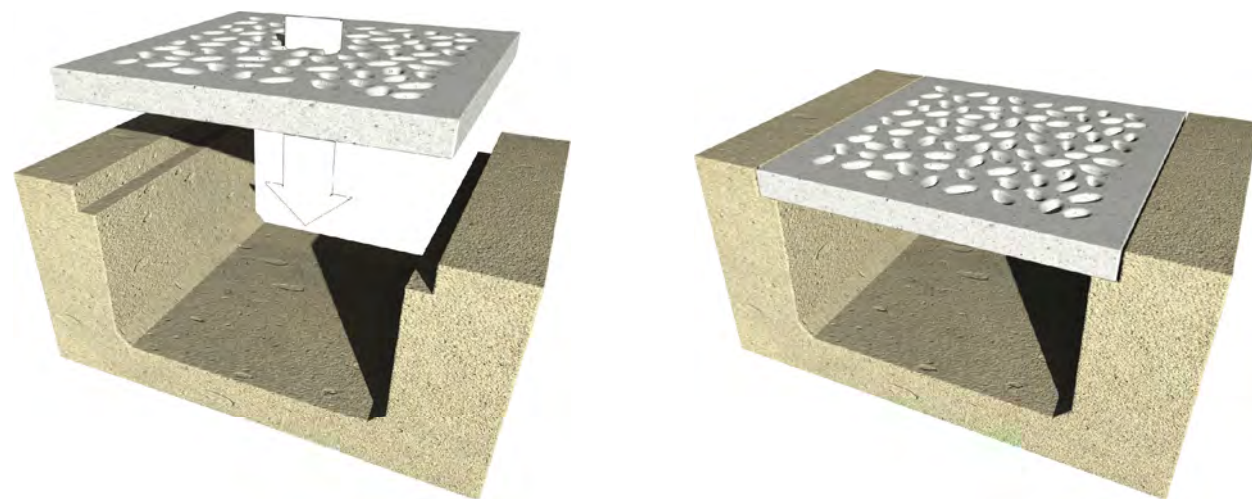
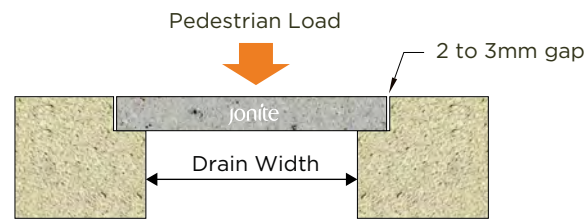

Install directly on flat and level concrete drains and tiles.

2 POOL GRATES WITH JONITE L-TRIMMERS™

Pool grates can be installed with Jonite L-Trimmers™ to provide a boost in aesthetics as well as to help level the support for the grates, which is highly essential in a pool environment.

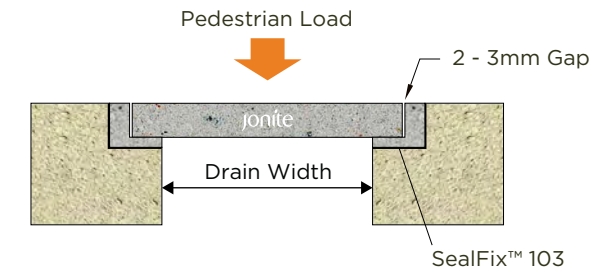

Jonite L-Trimmers™ is installed using dry fixing with SealFix™ 103 (epoxy mortar).

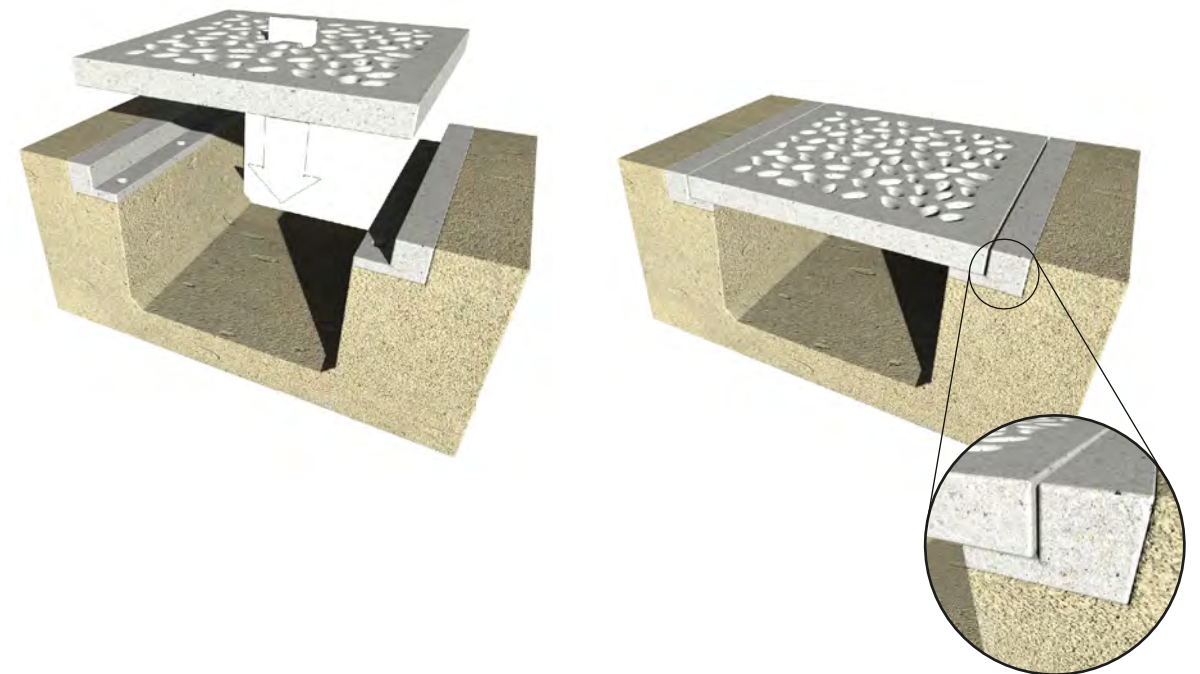

Jonite L-Trimmers™ provides a clean and aesthetically appealing installation.

3
POOL GRATES WITH JONITE STUD TRIMMERS™

Pools that require more water drainage to prevent splash can use Stud Trimmers™ with the pool grates to help improve the flow rates of the perimeter drains.

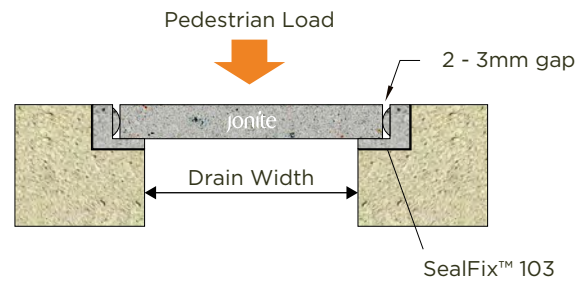

Jonite Stud Trimmers™ is installed using dry fixing with SealFix™ 103 (epoxy mortar).

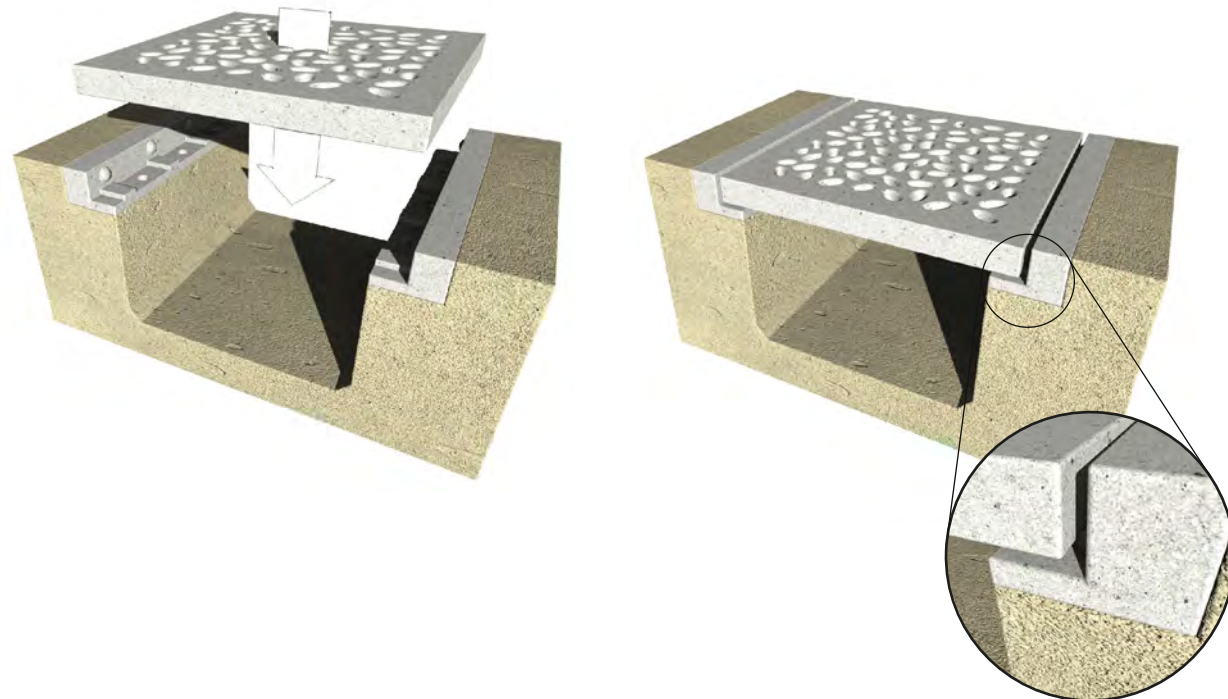

Studs on the trimmers provide increased perforation for improved flow rates.

Sump Covers

Installation

Sump covers all over the world are installed very differently. The methods in which Jonite sump covers are installed are highly dependent on the application and the size of the sump.

Sump covers for a vehicular use would require a higher level of support like L-steel angles or Jonite Trimmer Frame™.

For a large custom sump, the multiple panels can also be supported by a frame using L-steel angles or a custom Jonite Trimmer Frame™.

1
SMALL SUMP COVERS ON LEVEL CONCRETE

Only light-duty Jonite sump covers, which are strictly for pedestrian application (6KN-15KN), can be installed directly on level concrete as long as they are installed flatly with no visible rocking across all four sides of the support.

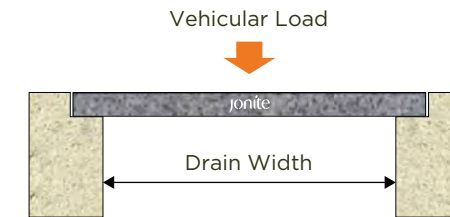

Install directly on level concrete sump.

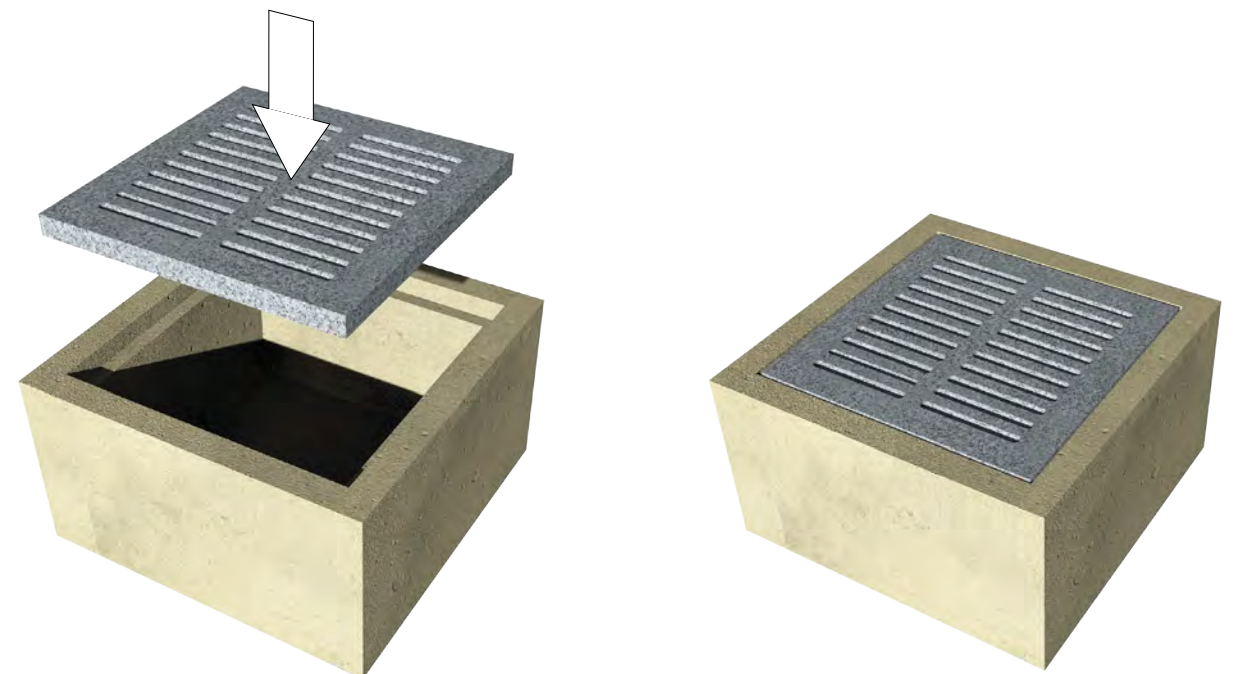

2
SMALL SUMP COVERS WITH JONITE TRIMMER FRAME™

Sump covers for vehicular application (125KN - 400KN), must be flatly installed on a 90-degree edge to ensure maximum performance. Jonite Trimmer Frame™ provides this with a bonus of aesthetic flair.

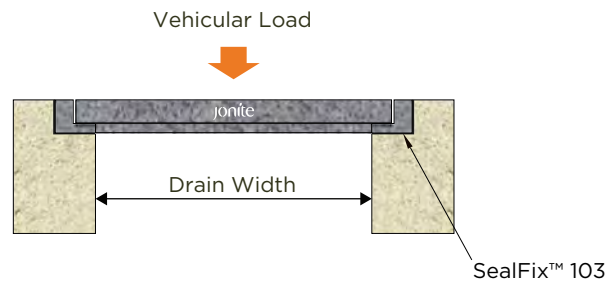

Jonite Trimmer Frame™ is installed using dry fixing with SealFix™ 103 (Epoxy mortar).

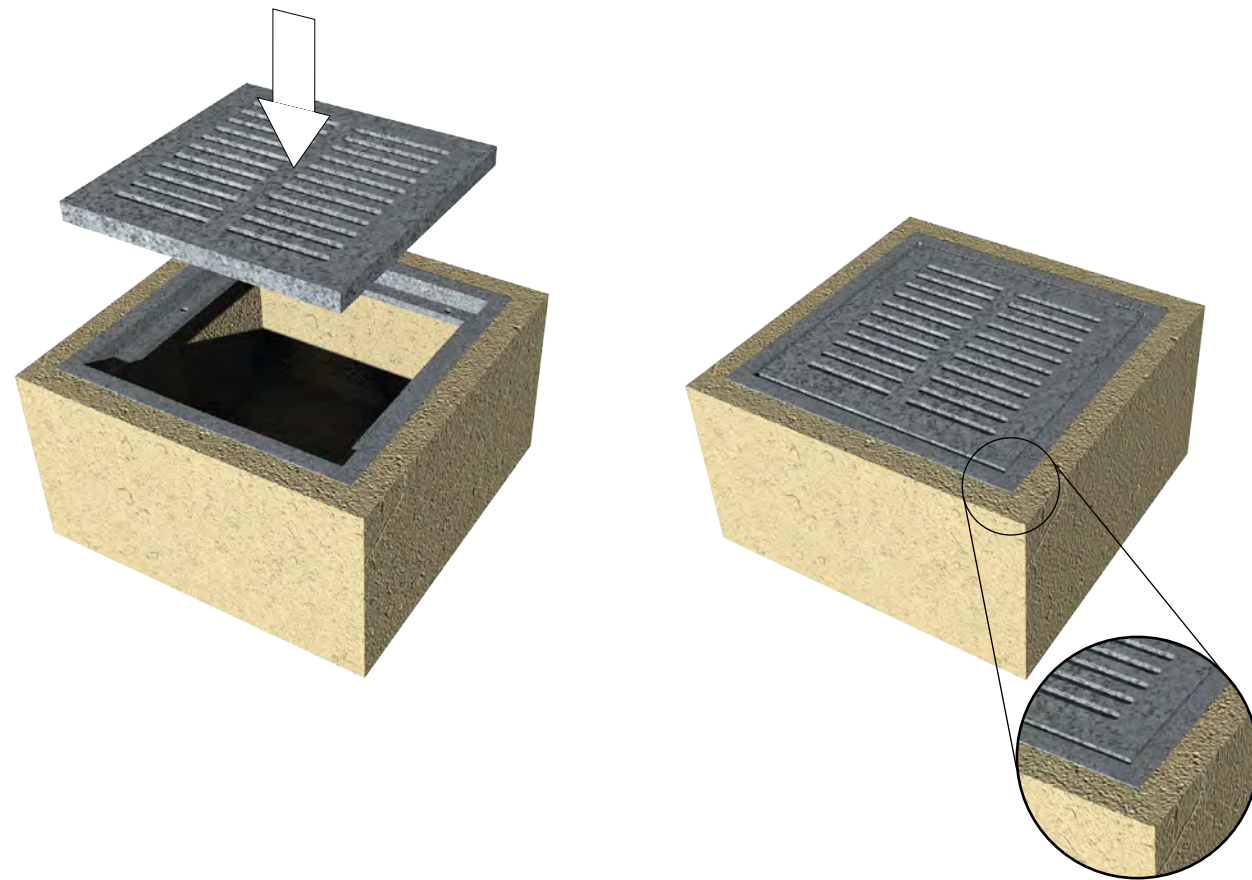

Jonite Trimmer Frame™ provides a clean and aesthetically appealing installation.

3
LARGE SUMP COVERS WITH L-STEEL ANGLES

For all large sump covers with multiple panels, a metal support frame is usually required. For sump covers requiring maintenance accessibility, a removable metal spline can be designed and fabricated.

For heavy-duty sump covers, they can be installed on a flat surface with a 90-degree edge by inverting an L-steel angle and welding a flat bar to the side. This is usually required on all four sides of the sump cover, creating a frame.

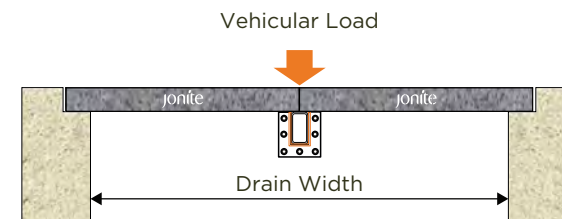
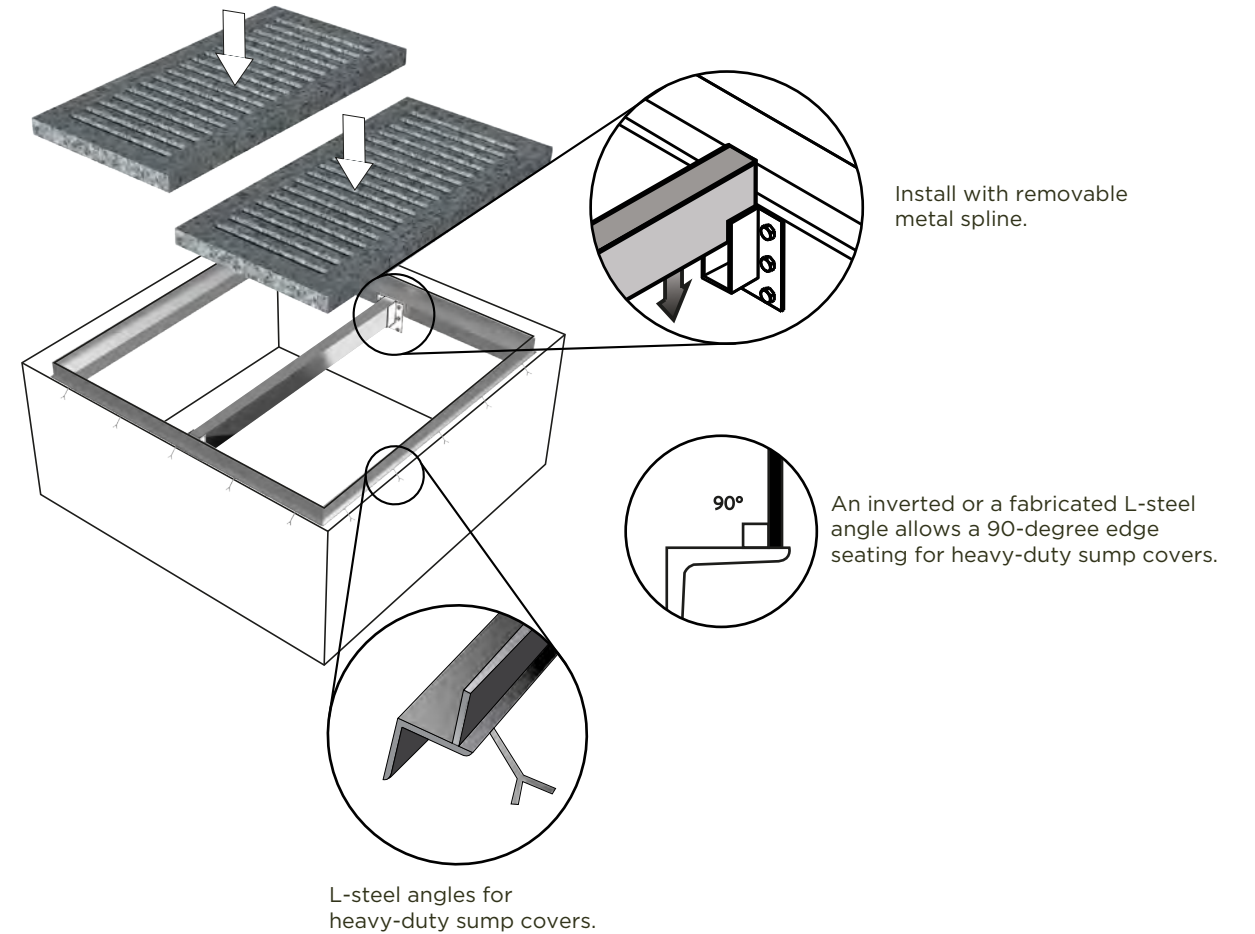

4
LARGE SUMP COVERS WITH JONITE TRIMMER FRAME™

Large sump covers with multiple panels can also use a Jonite Trimmer Frame™ as an alternative to the L-steel metal frame support. The Trimmer Frame™ provides the same 90-degree edge flat surface as the L-steel metal frame with an aesthetic bonus.

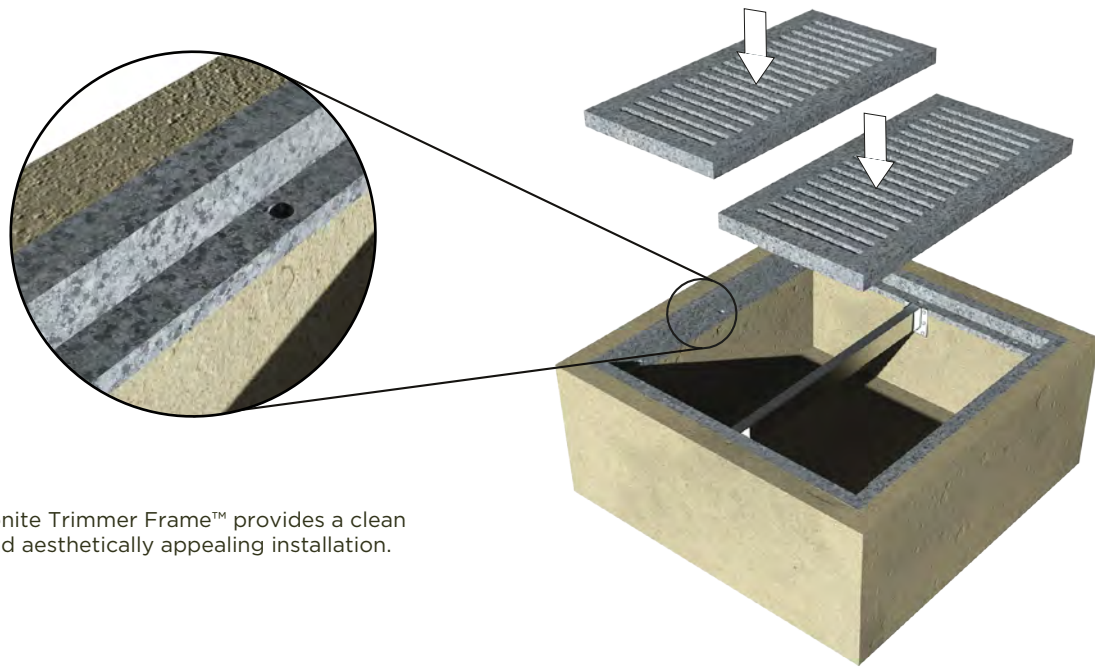

Jonite Trimmer Frame™ provides a clean and aesthetically appealing installation.

5
BASIN GRATES

Jonite basin grates are similar to sump covers functionally as a grate for a point drainage system. The main difference, however, is that the basin grates are specially designed to fit a specific model of a manufactured catch basin.

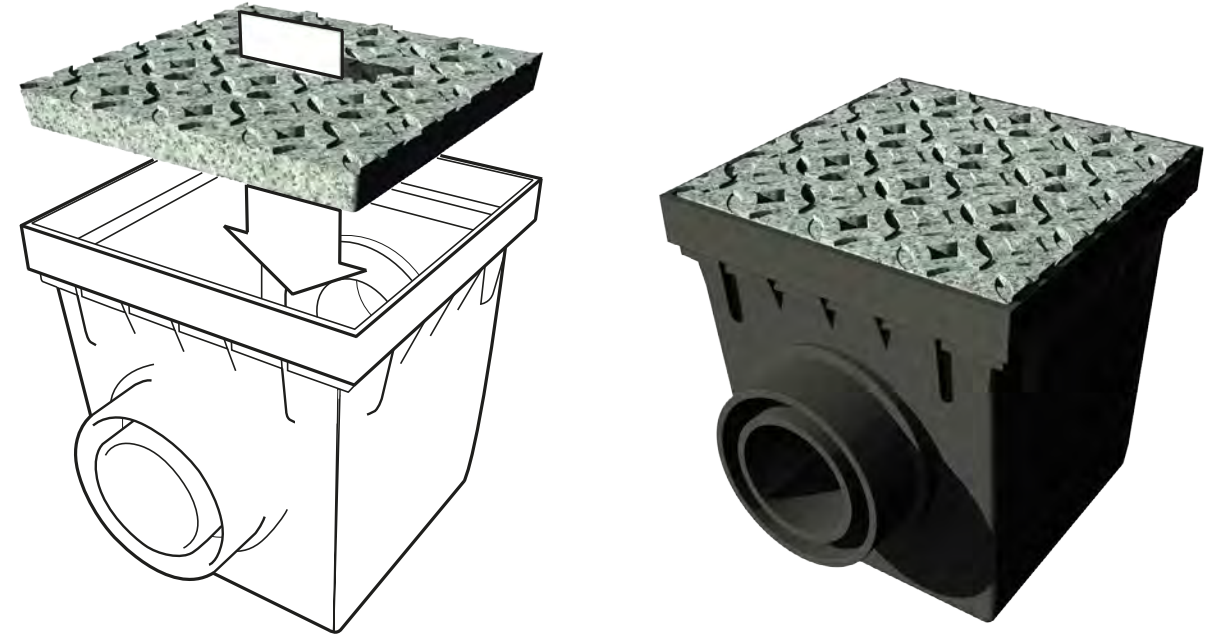

Install directly on the compatible catch basins

Basin grates are perfectly shaped to fit most catch basins.

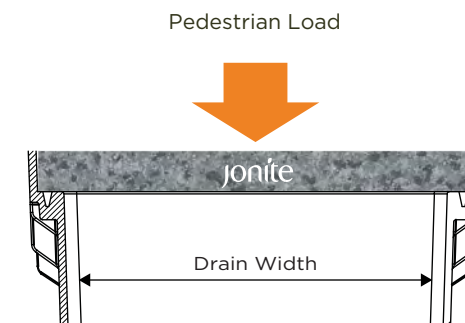
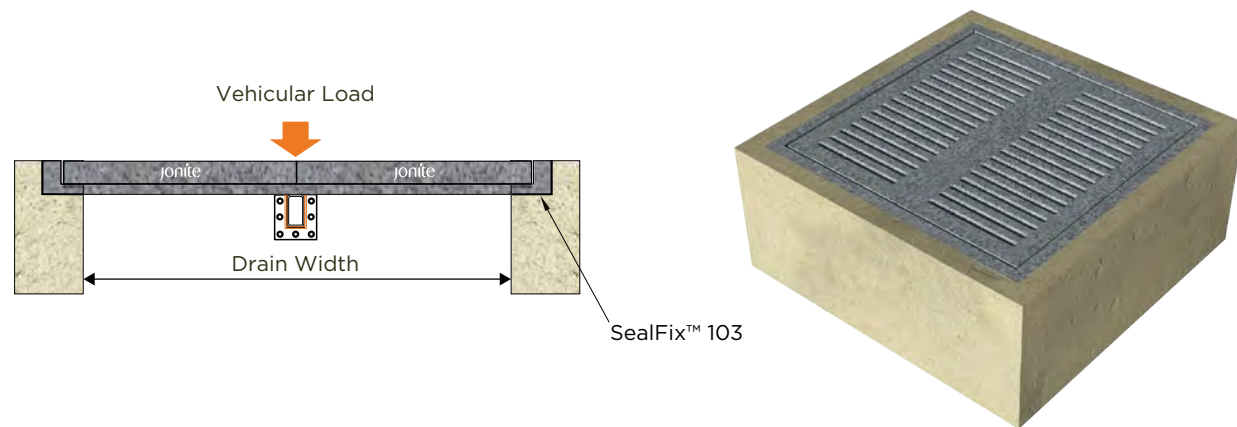

Copyright

© Copyright Reserved 2020. The materials, drawings and the design shown here are the exclusive property of Jonite Pte. Ltd. It shall not be copied nor its contents communicated or reproduced in any form and for any purpose without the prior specific authority in writing of Jonite Pte. Ltd.

Disclaimer

All reasonable care has been taken in compiling the information in this catalogue. All recommendations and suggestions on the use of Jonite products are made without guarantee since the conditions of use are beyond the control of the Company. It is the customer's responsibility to ensure that each product is fit for its intended purpose and that the actual conditions of use are suitable and appropriate.

This catalogue and any advice provided by Jonite Pte. Ltd are free of charge and accordingly, no liability of any kind (including liability for negligence) will attach to the Company or its agents arising out of or in connection with or in relation to this catalogue or any such advice. Any goods supplied by the Company will be supplied solely upon its standard conditions of sale, copies of which are available on request.

The company's policy of continuous product development and improvements renders specifications liable to modification. Information provided in this catalogue is therefore subject to change without prior notification.

Website

www.jonite.com

Social Media

 facebook.com/jonitestone

 pinterest.com/jonitestone

 linkedin.com/company/jonitestone

 instagram.com/jonitestone

Email

info@jonite.com

Phone

US +1-484-224-2972

Singapore +65-6383-3788