



AQUASCAPE

THRESHOLD DRAINAGE

DOMESTIC • URBAN • LANDSCAPE



 **LATERAL**
DESIGN STUDIO

Compliant and certified to load class A15 BS EN 1433:2002
Compliant with Part M of the Build Regulations for England and Wales

THRESHOLD DRAINAGE: AN INTRODUCTION

Discreet &
Stylish

The ultimate collection of sleek and adaptable threshold & patio drains

OUR UNIFLOW RANGE

Uniflow drains, are simple channel drains that collect water from only one source, that being the adjacent paved surfaces and not the water from door thresholds.

- 1 Threshold Slim Drain (Deep & Shallow)**
Narrow uniflow threshold channel drains for stepped door thresholds and patios.
- 2 Threshold Slim+ Drain (Deep & Shallow)**
105mm wide uniflow threshold channel drains for stepped door thresholds and patios.
- 3 Threshold Stone+ Drain (Deep)**
A deep 105mm wide uniflow stone threshold channel drain for stepped door thresholds and patios.

Threshold and patio uniflow drainage offers a winning combination of practical functionality and aesthetic appeal. Its efficient water management, safety benefits, easy maintenance, and design versatility make it an ideal choice for various architectural and domestic landscape projects. By seamlessly integrating into the overall design concept, threshold drainage systems enhance the visual appeal of spaces, creating harmonious and aesthetically pleasing environments.



Efficient Water Management

Our threshold drainage effectively manages water flow, diverting it away from critical areas such as doorways, entrances, and other vulnerable points. By preventing water ingress, it helps maintain the integrity of structures and protects against potential damage caused by water accumulation. A range of connectivity accessories are available to connect spigot outlets to Ø110mm drain systems.

Safety and Accessibility

The threshold drainage system eliminates the presence of hazardous water pooling, ensuring safe passage for pedestrians and reducing the risk of slip and fall accidents. It offers a level surface adjacent to door thresholds, making it wheelchair-friendly and compliant with accessibility standards.

Easy Maintenance

The design of our threshold drainage system facilitates easy maintenance. Debris and contaminants can be easily removed from the surface, preventing clogging and ensuring the system's efficient functioning. This saves time and reduces the need for frequent maintenance interventions.

Sleek and Minimalistic Design

With its ability to seamlessly blend into surrounding hardscape and landscape elements, our threshold drainage contributes to the overall coherence of your application. It can be integrated into gardens, pathways, and outdoor living spaces without detracting from the natural beauty of the environment.

Versatility

Our threshold drain grates can be customised to suit various architectural styles and design preferences. With a wide range of materials, finishes, colours, and grate options available, our threshold systems seamlessly integrate into different environments, from traditional to contemporary.

Visual Continuity

By effectively hiding drainage elements, by the use of our grate styles, materials and colour options, our threshold drain offering ensures visual continuity and uninterrupted aesthetics. It allows designers to create uncluttered and visually pleasing spaces without compromising the drainage functionality.

FLEXIBLE & DURABLE

Our meticulously designed threshold drain system combines discreteness and decorative appeal, providing an optimal solution for diverse applications. Its flexible nature allows for effortless adjustments, ensuring seamless integration in any setting.

Experience the convenience of quick and trouble-free installation, enabling you to swiftly finalise your project. To enhance the visual allure, our system offers a splendid assortment of removable top gratings crafted from premium materials, including aluminum, corten steel, and stainless steel. Each option can be further enhanced with a variety of decorative finishes, allowing you to effortlessly harmonise with your surrounding environment.

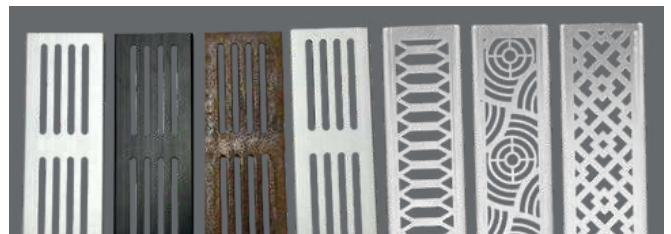

THRESHOLD DRAINAGE

DECORATIVE COVERS

In addition to our standard aluminium, stainless steel and corten steel cover design for our slimline drains, we proudly offer an array of premium decorative designer covers, crafted from 316 stainless steel for our esteemed threshold, patio slim drain system. These premium covers have been meticulously designed to not only exhibit exceptional aesthetics but also exemplify the highest standards of functionality. These covers can be personalised to suit individual preferences through a range of captivating finishes, enabling seamless integration into any architectural setting.

THRESHOLD SLIM DRAIN - DECORATIVE COVERS

Our aesthetically designed and robust decorative 316 stainless steel covers are manufactured from 70% recycled stainless steel and feature a beautiful, brushed finish. There are three designs available with matching gully covers.



Oblique

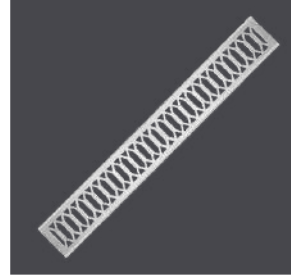

Hexagon



Waves

ACCESSORIES - CORNER UNITS & T-UNITS

For a comprehensive solution, our threshold system offers a complete range of accessories including corner and T-units. These can also feature our decorative stainless-steel covers as shown here.

Please see page 10 for our matching gully covers.



Oblique

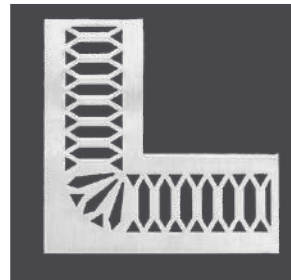

Hexagon



Waves

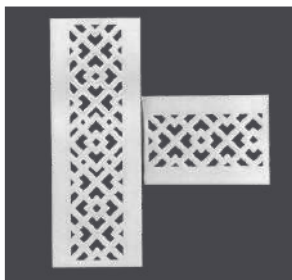

Oblique

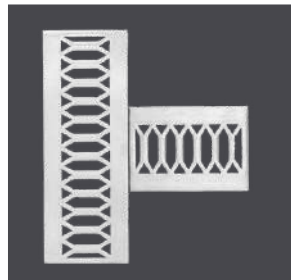

Hexagon



Waves

POWDER COATING FINISHES

Powder coating is surface finish for aluminum and stainless steel grates, that provides almost any RAL colour or shade to be applied, in both solid or metallic colours. This long-lasting, highly durable finish, will further fine tune the grate to coordinate with your adjacent paving and or door threshold.



THRESHOLD SLIM DRAIN

- 65mm Wide x 100mm Deep
- 65mm Wide x 60mm Shallow

A fully versatile slimline uniflow threshold and patio drain system with 7 different decorative covers and accessories.



A15

ABOUT

Introducing our slimline uniflow threshold, patio drain system, a discreet PVC channel drain solution with stunning removable heel safe gratings. Choose from aluminium, decorative stainless steel, or corten gratings. It offers quick and easy installation, along with flexible and easily adjustable layouts.

Designed for domestic light traffic areas, it has an A15 load class. Available in 1000mm lengths, our system comes with a full range of accessories for each channel with coordinated gully covers, providing a comprehensive drainage solution. Achieve practical functionality and aesthetic appeal with our slimline threshold drain system.

BENEFITS & FEATURES

- Discreet 65mm PVC channel system with 7 different heel-safe gratings.
- Both deep and shallow channels.
- Quick and easy installation.
- Click fit covers facilitate easy maintenance.
- Flexible and easily adjustable layout.
- Compliant with British Standards & accessibility requirements.
- Aluminium, stainless steel and corten steel gratings available.
- A15 load class for light traffic areas.
- A full range of accessories, gully and Ø110 drain connections available.
- Matching gully covers available (please see page 10).

CORRECT APPLICATIONS

Domestic, Stepped Door Thresholds, Patios, Driveways, Courtyards, Pool & Spas Decks, MUGA Areas, Tennis Courts, Landscape Areas

(Not Suitable for Flush Level Door Thresholds)

MAXIMUM FLOW RATE

65mm x 100mm
Deep

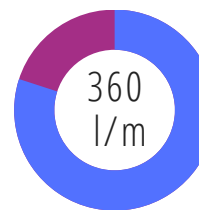

65mm x 60mm
Shallow

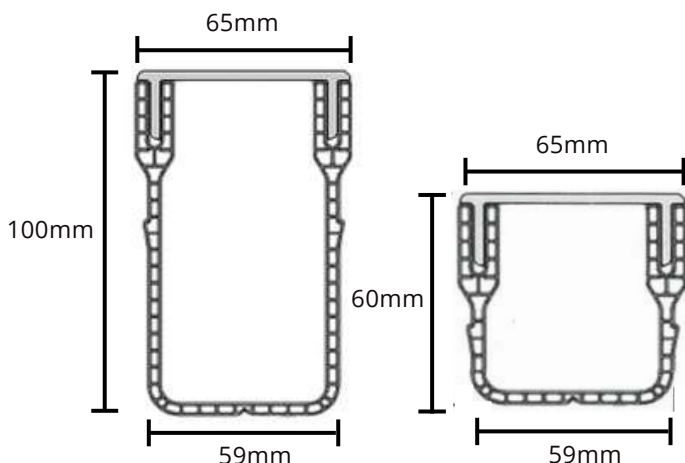
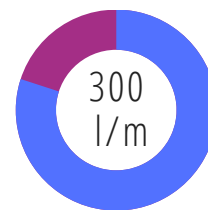

THRESHOLD SLIM DRAIN

65mm Wide x 100mm Deep

A fully versatile deep slimline uniflow threshold and patio drain system comes with a range of 7 different covers and accessories for standard on site sub-base build-ups.



PRODUCTS

Part Number	Description	Length (mm)	Width (mm)	Depth (mm)	Invert (mm)	Weight (kg)
THRESHOLD SLIM DRAIN - 65mm Wide x 100mm Deep						
With Standard Covers						
99002	1m Threshold Slim Drain with Silver Aluminium Grating	1000	65	100	96	1.8
99003	1m Threshold Slim Drain with Black Aluminium Grating	1000	65	100	96	1.8
99004	1m Threshold Slim Drain with Stainless Steel Grating	1000	65	100	96	2.8
99005	1m Threshold Slim Drain with Corten Steel Grating	1000	65	100	96	2.8
With Decorative Covers						
99007	1m Threshold Slim Drain with Oblique Stainless Steel Grating	1000	65	100	96	2.4
99008	1m Threshold Slim Drain with Hexagon Stainless Steel Grating	1000	65	100	96	2.4
99009	1m Threshold Slim Drain with Waves Stainless Steel Grating	1000	65	100	96	2.4

Special Finishes Available On All Covers: Powder Coating, all RAL colours, solid and metallic

ACCESSORIES - CORNER UNITS & T-UNITS

With Standard Covers						
99011	Corner Unit with Silver Aluminium Grating	150/150	65	100	96	0.4
99012	Corner Unit with Black Aluminium Grating	150/150	65	100	96	0.4
99013	Corner Unit with Corten Steel Grating	150/150	65	100	96	0.7
99014	Corner Unit with Stainless Steel Grating	150/150	65	100	96	0.7
99015	T-Unit with Silver Aluminium Grating	155/182	65	100	96	0.5
99016	T-Unit with Black Aluminium Grating	155/182	65	100	96	0.5
99017	T-Unit with Corten Steel Grating	155/182	65	100	96	0.8
99018	T-Unit with Stainless Steel Grating	155/182	65	100	96	0.8
With Decorative Covers						
99020	Corner Unit with Oblique Stainless Steel Grating	150/150	65	100	96	0.6
99021	Corner Unit with Hexagon Stainless Steel Grating	150/150	65	100	96	0.6
99022	Corner Unit with Waves Stainless Steel Grating	150/150	65	100	96	0.6
99023	T-Unit with Oblique Stainless Steel Grating	155/182	65	100	96	0.7
99024	T-Unit with Hexagon Stainless Steel Grating	155/182	65	100	96	0.7
99025	T-Unit with Waves Stainless Steel Grating	155/182	65	100	96	0.7

Special Finishes Available On All Covers: Powder Coating, all RAL colours, solid and metallic

OTHER ACCESSORIES

99027	Closing End Cap	20	65	100	n/a	0.1
99028	Outlet End Cap with Ø50mm Outlet	20	65	100	n/a	0.1
99029	Channel Connector	100	65	100	n/a	0.1
99030	Channel Connector with Ø80mm Vertical Outlet	100	65	100	n/a	0.1
50001	Outlet Adapter Ø110mm / Ø86mm	n/a	n/a	n/a	n/a	0.1
50002	Hole Saw & Arbor Ø45mm	n/a	n/a	n/a	n/a	0.5
50004	Cover Lifting Key	n/a	n/a	n/a	n/a	0.1
50005	CT1 Adhesive & Sealant Clear	n/a	n/a	n/a	n/a	0.6
50010	Threshold Slim Drain Leaf Guard (65mm)	110	46	65	n/a	0.04



Closing End Cap



Outlet End Cap with
Ø50mm Outlet

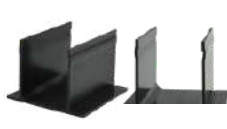

Channel Connector



Channel Connector with
Ø80mm Vertical Outlet



Outlet Adapter
Ø110mm / Ø86mm



Hole Saw &
Arbor Ø45mm



Threshold Slim Drain
Leaf Guard



THRESHOLD SLIM DRAIN

65mm Wide x 60mm Shallow

A fully versatile deep slimline uniflow threshold and patio drain system comes with a range of 7 different covers and accessories for standard on site sub-base build-ups.



PRODUCTS

Part Number	Description	Length (mm)	Width (mm)	Depth (mm)	Invert (mm)	Weight (kg)
THRESHOLD SLIM DRAIN - 65mm Wide x 60mm Shallow						
With Standard Covers						
99032	1m Threshold Slim Drain with Silver Aluminium Grating	1000	65	60	56	1.4
99033	1m Threshold Slim Drain with Black Aluminium Grating	1000	65	60	56	1.4
99034	1m Threshold Slim Drain with Stainless Steel Grating	1000	65	60	56	2.5
99035	1m Threshold Slim Drain with Corten Steel Grating	1000	65	60	56	2.5
With Decorative Covers						
99037	1m Threshold Slim Drain with Oblique Stainless Steel Grating	1000	65	60	56	2.0
99038	1m Threshold Slim Drain with Hexagon Stainless Steel Grating	1000	65	60	56	2.0
99039	1m Threshold Slim Drain with Waves Stainless Steel Grating	1000	65	60	56	2.0

Special Finishes Available On All Covers: Powder Coating, all RAL colours, solid and metallic

ACCESSORIES - CORNER UNITS & T-UNITS

With Standard Covers						
99041	Corner Unit with Silver Aluminium Grating	150/150	65	60	56	0.3
99042	Corner Unit with Black Aluminium Grating	150/150	65	60	56	0.3
99043	Corner Unit with Corten Steel Grating	150/150	65	60	56	0.6
99044	Corner Unit with Stainless Steel Grating	150/150	65	60	56	0.6
99045	T-Unit with Silver Aluminium Grating	155/182	65	60	56	0.4
99046	T-Unit with Black Aluminium Grating	155/182	65	60	56	0.4
99047	T-Unit with Corten Steel Grating	155/182	65	60	56	0.7
99048	T-Unit with Stainless Steel Grating	155/182	65	60	56	0.7
With Decorative Covers						
99050	Corner Unit with Oblique Stainless Steel Grating	150/150	65	60	56	0.5
99051	Corner Unit with Hexagon Stainless Steel Grating	150/150	65	60	56	0.5
99052	Corner Unit with Waves Stainless Steel Grating	150/150	65	60	56	0.5
99053	T-Unit with Oblique Stainless Steel Grating	155/182	65	60	56	0.6
99054	T-Unit with Hexagon Stainless Steel Grating	155/182	65	60	56	0.6
99055	T-Unit with Waves Stainless Steel Grating	155/182	65	60	56	0.6

Special Finishes Available On All Covers: Powder Coating, all RAL colours, solid and metallic

OTHER ACCESSORIES

99057	Closing End Cap	20	65	60	n/a	0.1
99058	Outlet End Cap with Ø40mm Outlet	20	65	60	n/a	0.1
99059	Channel Connector	100	65	60	n/a	0.1
99060	Channel Connector with Ø80mm Vertical Outlet	100	65	60	n/a	0.1
50001	Outlet Adapter Ø110mm / Ø86mm	n/a	n/a	n/a	n/a	0.1
50002	Hole Saw & Arbor Ø45mm	n/a	n/a	n/a	n/a	0.5
50004	Cover Lifting Key	n/a	n/a	n/a	n/a	0.1
50005	CT1 Adhesive & Sealant Clear	n/a	n/a	n/a	n/a	0.6



Closing End Cap



Outlet End Cap with
Ø40mm Outlet



Channel Connector



Channel Connector with
Ø80mm Vertical Outlet



Outlet Adapter
Ø110mm / Ø86mm



Hole Saw &
Arbor Ø45mm



THRESHOLD SLIM+ DRAIN

- 105mm Wide x 100mm Deep
- 105mm Wide x 50mm Shallow

A fully versatile slimline+ uniflow threshold & patio drain, greater water capacity with 3 different covers and accessories.



A15

ABOUT

Introducing a wider slimline uniflow threshold, patio drain system that allows rainwater down pipes to be dropped into the drain channel, with greater water capacity. A semi-discreet PVC channel drain solution with stunning removable heel safe gratings. Choose from aluminium, stainless steel gratings. It offers quick and easy installation, along with flexible and easily adjustable layouts.

Designed for domestic light traffic areas, it has an A15 load class where you require greater flow rates. Available in 1000mm lengths, our system comes with a full range of accessories for each channel, with coordinated gully covers, providing a comprehensive drainage solution. Achieve practical functionality and aesthetic appeal with our slimline threshold drain system.

BENEFITS & FEATURES

- Discreet 105mm PVC channel system with three different heel-safe gratings.
- Takes rainwater down pipes with greater water capacity.
- With deep and shallow channels.
- Quick and easy installation.
- Click fit covers facilitate easy maintenance.
- Flexible and easily adjustable layout.
- Compliant with British Standards & accessibility requirements.
- Aluminium, and stainless steel gratings.
- A15 load class for light traffic areas.
- A full range of accessories, and Ø110 drain connections available.

CORRECT APPLICATIONS

Domestic, Stepped Door Thresholds, Patios, Driveways, Courtyards, Pool & Spas Decks, MUGA Areas, Tennis Courts, Landscape Areas

(Not Suitable for Flush Level Door Thresholds)

MAXIMUM FLOW RATE

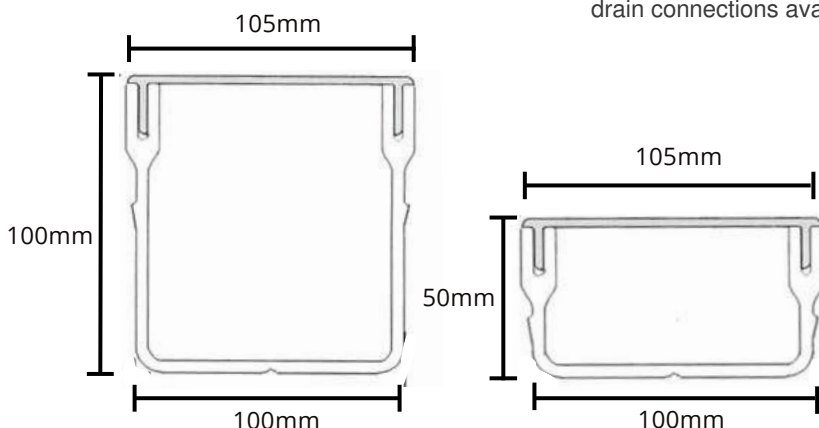
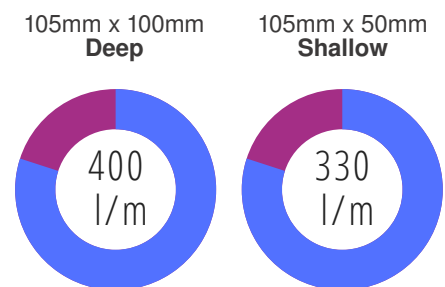

THRESHOLD SLIM+ DRAIN

105mm Wide x 100mm Deep



A fully versatile deep slimline uniflow threshold and patio drain system with greater flow rate, comes with a range of 3 different covers and accessories for standard on site sub-base build-ups.

PRODUCTS

Part Number	Description	Length (mm)	Width (mm)	Depth (mm)	Invert (mm)	Weight (kg)
THRESHOLD SLIM+ DRAIN - 105mm Wide x 100mm Deep						
With Standard Covers						
99062	1m Threshold Slim+ Drain with Silver Aluminium Grating	1000	105	100	96	2.9
99063	1m Threshold Slim+ Drain with Black Aluminium Grating	1000	105	100	96	2.9
99064	1m Threshold Slim+ Drain with Stainless Steel Grating	1000	105	100	96	4.1

Decorative Stainless Steel covers available on request.

Special Finishes Available On All Covers: Powder Coating, all RAL colours, solid and metallic

ACCESSORIES - CORNER UNITS & T-UNITS

With Standard Covers						
99066	Corner Unit with Silver Aluminium Grating	197/197	105	100	96	0.7
99067	Corner Unit with Black Aluminium Grating	197/197	105	100	96	0.7
99068	Corner Unit with Stainless Steel Grating	197/197	105	100	96	1.0
99069	T-Unit with Silver Aluminium Grating	197/272	105	100	96	0.8
99070	T-Unit with Black Aluminium Grating	197/272	105	100	96	0.8
99071	T-Unit with Stainless Steel Grating	197/272	105	100	96	1.2

Decorative Stainless Steel covers available on request.

Special Finishes Available On All Covers: Powder Coating, all RAL colours, solid and metallic

OTHER ACCESSORIES

99073	Closing End Cap	20	105	100	n/a	0.1
99074	Outlet End Cap with Ø75mm Outlet	20	105	100	n/a	0.1
99075	Channel Connector	135	105	100	n/a	0.1
99076	Channel Connector with Ø110mm Vertical Outlet	135	105	100	n/a	0.1
50003	Hole Saw & Arbor Ø75mm	n/a	n/a	n/a	n/a	0.5
50004	Cover Lifting Key	n/a	n/a	n/a	n/a	0.1
50005	CT1 Adhesive & Sealant Clear	n/a	n/a	n/a	n/a	0.65



Closing End Cap



Outlet End Cap with
Ø75mm Outlet



Channel Connector



Channel Connector with
Ø110mm Vertical Outlet



Hole Saw &
Arbor Ø75mm

THRESHOLD SLIM+ DRAIN

105mm Wide x 50mm Shallow

A fully versatile deep slimline uniflow threshold and patio drain system with greater flow rate, comes with a range of 3 different covers and accessories for standard on site sub-base build-ups.



PRODUCTS

Part Number	Description	Length (mm)	Width (mm)	Depth (mm)	Invert (mm)	Weight (kg)
THRESHOLD SLIM+ DRAIN - 105mm Wide x 50mm Shallow						
With Standard Covers						
99078	1m Threshold Slim+ Drain with Silver Aluminium Grating	1000	105	50	46	2.5
99079	1m Threshold Slim+ Drain with Black Aluminium Grating	1000	105	50	46	2.5
99080	1m Threshold Slim+ Drain with Stainless Steel Grating	1000	105	50	46	3.6

Decorative Stainless Steel covers available on request.

Special Finishes Available On All Covers: Powder Coating, all RAL colours, solid and metallic

ACCESSORIES - CORNER UNITS & T-UNITS

With Standard Covers						
99082	Corner Unit with Silver Aluminium Grating	197/197	105	50	46	0.6
99083	Corner Unit with Black Aluminium Grating	197/197	105	50	46	0.6
99084	Corner Unit with Stainless Steel Grating	197/197	105	50	46	0.9
99085	T-Unit with Silver Aluminium Grating	197/272	105	50	46	0.7
99086	T-Unit with Black Aluminium Grating	197/272	105	50	46	0.7
99087	T-Unit with Stainless Steel Grating	197/272	105	50	46	1.2

Decorative Stainless Steel covers available on request.

Special Finishes Available On All Covers: Powder Coating, all RAL colours, solid and metallic

OTHER ACCESSORIES

99089	Closing End Cap	20	105	50	n/a	0.1
99090	Outlet End Cap with Ø30mm Outlet	20	105	50	n/a	0.1
99091	Channel Connector	135	105	50	n/a	0.2
99092	Channel Connector with Ø110mm Vertical Outlet	135	105	50	n/a	0.2
50003	Hole Saw & Arbor Ø75mm	n/a	n/a	n/a	n/a	0.5
50004	Cover Lifting Key	n/a	n/a	n/a	n/a	0.1
50005	CT1 Adhesive & Sealant Clear	n/a	n/a	n/a	n/a	0.65



Closing End Cap



Outlet End Cap with
Ø30mm Outlet



Channel Connector



Channel Connector with
Ø110mm Vertical Outlet



Hole Saw &
Arbor Ø75mm



THRESHOLD DRAINAGE MATCHING GULLYS

In addition to our designer channel grates, you can complete your drainage installation with one of our beautiful matching gully covers with black plastic gully frame that works with standard underground gully bases.

Available in brushed stainless steel, each of our matching gully covers can be powder coated to any RAL colour or shade, both solid or metallic. Our covers can also be retrofitted into existing standard underground gully bases, including; Hunter, Polypipe, Marley, Brett Martin, Osma etc.

STAINLESS STEEL

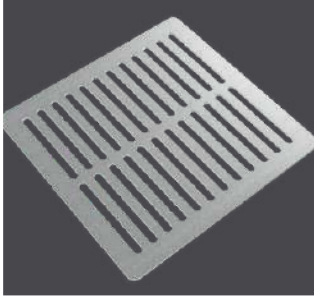

Standard Slotted

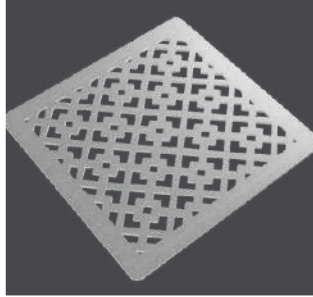

Oblique

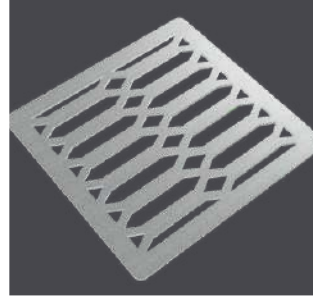

Hexagon



Waves



PRODUCTS

Part Number	Description	Length (mm)	Width (mm)	Depth (mm)	Invert (mm)	Weight (kg)
GULLY COVERS						
<i>Comes With Black Hopper Frame</i>						
99117	Standard Slotted Stainless Steel Grating & Black Plastic Gully Hopper	148	148	n/a	n/a	1.3
99118	Oblique Stainless Steel Grating & Black Plastic Gully Hopper	148	148	n/a	n/a	1.3
99119	Hexagon Stainless Steel Grating & Black Plastic Gully Hopper	148	148	n/a	n/an/a	1.3
99120	Waves Stainless Steel Grating & Black Plastic Gully Hopper	148	148	n/a		1.4

Special Finishes Available On All Covers: Powder Coating, all RAL colours, solid and metallic

RETROFIT GULLY COVER

99100	Standard Slotted Stainless Steel Grating	148	148	n/a	n/a	0.6
99101	Oblique Stainless Steel Grating	148	148	n/a	n/a	0.6
99102	Hexagon Stainless Steel Grating	148	148	n/a	n/a	0.6
99103	Waves Stainless Steel Grating	148	148	n/a	n/a	0.7

Special Finishes Available On All Covers: Powder Coating, all RAL colours, solid and metallic



THRESHOLD STONE+ DRAIN

- 105mm Wide x 100mm Deep

New French Drain Concept, a uniflow threshold and patio drain with recessed aluminium cover to take stone pebbles.



A15

ABOUT

Introducing our New French threshold drain system without the usual historic defects, a functional threshold drain for classic or contemporary paved areas. A drain system that allows rainwater down pipes to be dropped into the drain channel, with greater water capacity. A unique concept giving a classic aesthetic look, but with modern water capturing PVC channel. Comes with removable silver or black anodized aluminum covers. Quick and easy installation, along with a flexible and easily adjustable layout.

Designed for domestic areas, A15 load class. Available in 1000mm lengths. Our system comes with a range of accessories, providing another comprehensive drainage solution with both functionality and historic appeal.

BENEFITS & FEATURES

- French drain look with PVC channel system.
- Takes rainwater down pipes with greater water capacity.
- With aluminium covers in silver and black.
- Quick and easy installation.
- Flexible and easily adjustable layout.
- Facilitates easy maintenance.
- A15 load class for light traffic areas.
- Available in lengths of 1000mm.
- A full range of accessories and Ø110mm drain connections available.

CORRECT APPLICATIONS

Domestic, Stepped Door Thresholds, Patios, Driveways, Historic Courtyards, Landscape Areas,

(Not Suitable for Flush Level Thresholds)

MAXIMUM FLOW RATE

105mm x 100mm
Deep

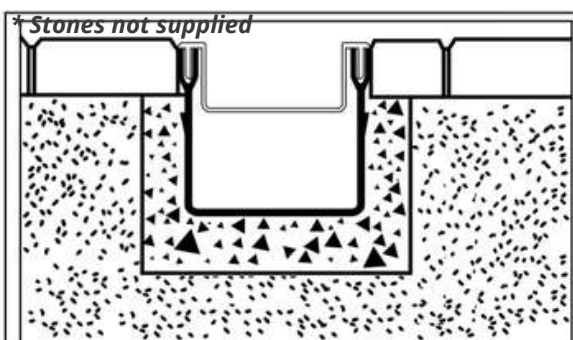
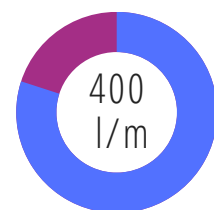

THRESHOLD STONE+ DRAIN

105mm Wide x 100mm Deep

A Modern French drain, uniflow threshold and patio drain system with two different recessed cover, the profile designed to accept stone pebbles comes in silver or black anodized aluminium finish and accessories.



PRODUCTS

Part Number	Description	Length (mm)	Width (mm)	Depth (mm)	Invert (mm)	Weight (kg)
THRESHOLD STONE+ DRAIN - 105mm x 100mm Deep						
With Standard Covers						
99105	1m Threshold Stone+ Drain with Silver Aluminium Recessed Grating	1000	105	100	96	2.9
99106	1m Threshold Stone+ Drain with Black Aluminium Recessed Grating	1000	105	100	96	2.9

ACCESSORIES - CORNER UNITS & T-UNITS

With Standard Covers						
99107	Corner Unit with Silver Aluminium Recessed Grating	197/197	105	100	96	0.7
99108	Corner Unit with Black Aluminium Recessed Grating	197/197	105	100	96	0.7
99109	T-Unit with Silver Aluminium Recessed Grating	197/197	105	100	96	0.8
99110	T-Unit with Black Aluminium Recessed Grating	197/197	105	100	96	0.8

OTHER ACCESSORIES

99112	Closing End Cap	20	105	100	n/a	0.1
99113	Outlet End Cap with Ø75mm Outlet	20	105	100	n/a	0.1
99114	Channel Connector	135	105	100	n/a	0.1
99115	Channel Connector with Ø110mm Vertical Outlet	135	105	100	n/a	0.1
50003	Hole Saw & Arbor Ø75mm	n/a	n/a	n/a	n/a	0.5
50004	Cover Lifting Key	n/a	n/a	n/a	n/a	0.1
50005	CT1 Adhesive & Sealant Clear	n/a	n/a	n/a	n/a	0.65



Closing End Cap



Outlet End Cap with
Ø75mm Outlet



Channel Connector



Channel Connector with
Ø110mm Vertical Outlet





Hole Saw &
Arbor Ø75mm

* Stones not supplied

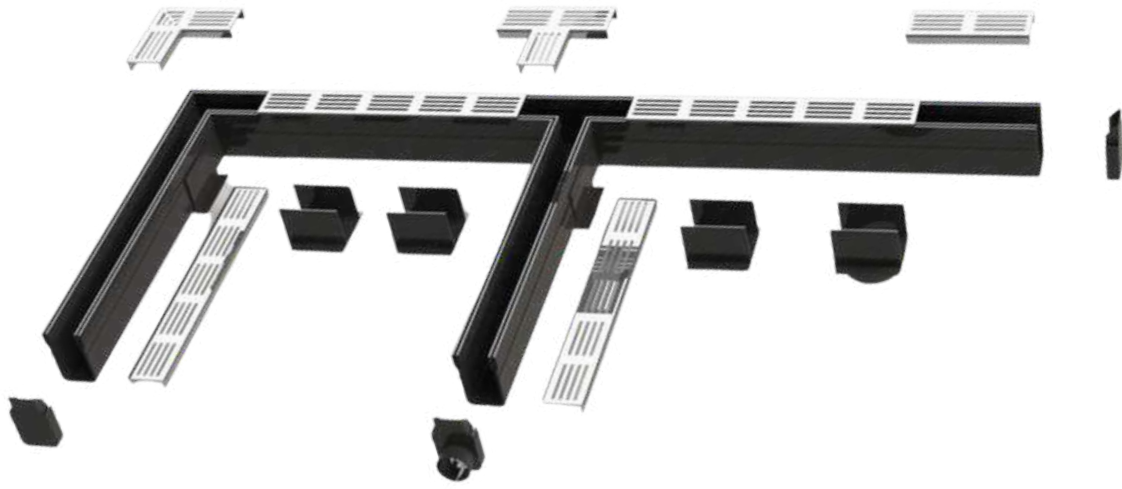



Lateral Design Studio Ltd, Unit 4 Double Arches Farm, Eastern Way, Heath & Reach, Bedfordshire LU7 9LF

 lateraldesignstudio.co.uk  020 8450 2244  info@lateraldesignstudio.co.uk