

PARTS LIST:

1	Driver/Left sidebar	4	12mm x 32mm OD x 3mm Flat Washer
1	Passenger/Right sidebar	4	12mm x 24mm OD x 2.5mm Flat Washer
1	Driver/Left Front Mounting Bracket	6	12mm Lock Washers
1	Passenger/Right Front Mounting Bracket	6	12mm Hex Nuts
1	Driver/Left Front Inner Support Bracket (4WD Vehicles With Skid Plate Only)	1	10-1.5mm x 40mm Hex Bolt
1	Driver/Left Front Inner Support Bracket (2WD & 4WD Vehicles W/O Skid Plate Only)	2	10-1.5mm x 35mm Hex Bolts
1	Passenger/Right Inner Support Bracket	6	10-1.5mm x 30mm Hex Bolts
2	Driver/Left Outer Support Brackets (fits left front and left rear only)	18	10mm x 30mm x 2.5mm Flat Washers
2	Passenger/Right Outer Support Brackets (fits right front and right rear only)	8	10mm Lock Washers
1	Driver/Left Rear Mounting Bracket	8	10mm Hex Nuts
1	Passenger/Right Rear Mounting Bracket	3	10mm Nylon Lock Nuts
1	Driver/Left Rear Inner Support Bracket	8	8-1.25mm x 25mm Hex Bolts
1	Passenger/Right Rear Inner Support Bracket	8	8mm x 24mm OD x 2mm Flat Washers
4	12-1.75mm x 40mm Bolt Plates (use for Outer Support Brackets only)	8	8mm Lock Washers
2	10-1.5mm x 35mm Long Bolt Plates (use for Rear Brackets only)	8	6-1.0mm x 25mm Hex Bolts
2	10-1.5mm x 35mm Short Bolt Plates (use for Front Inner Support Brackets only)	16	6mm x 18mm OD x 1.6mm Flat Washers
2	12-1.75mm x 35mm Hex Bolts	8	6mm Nylon Lock Nuts

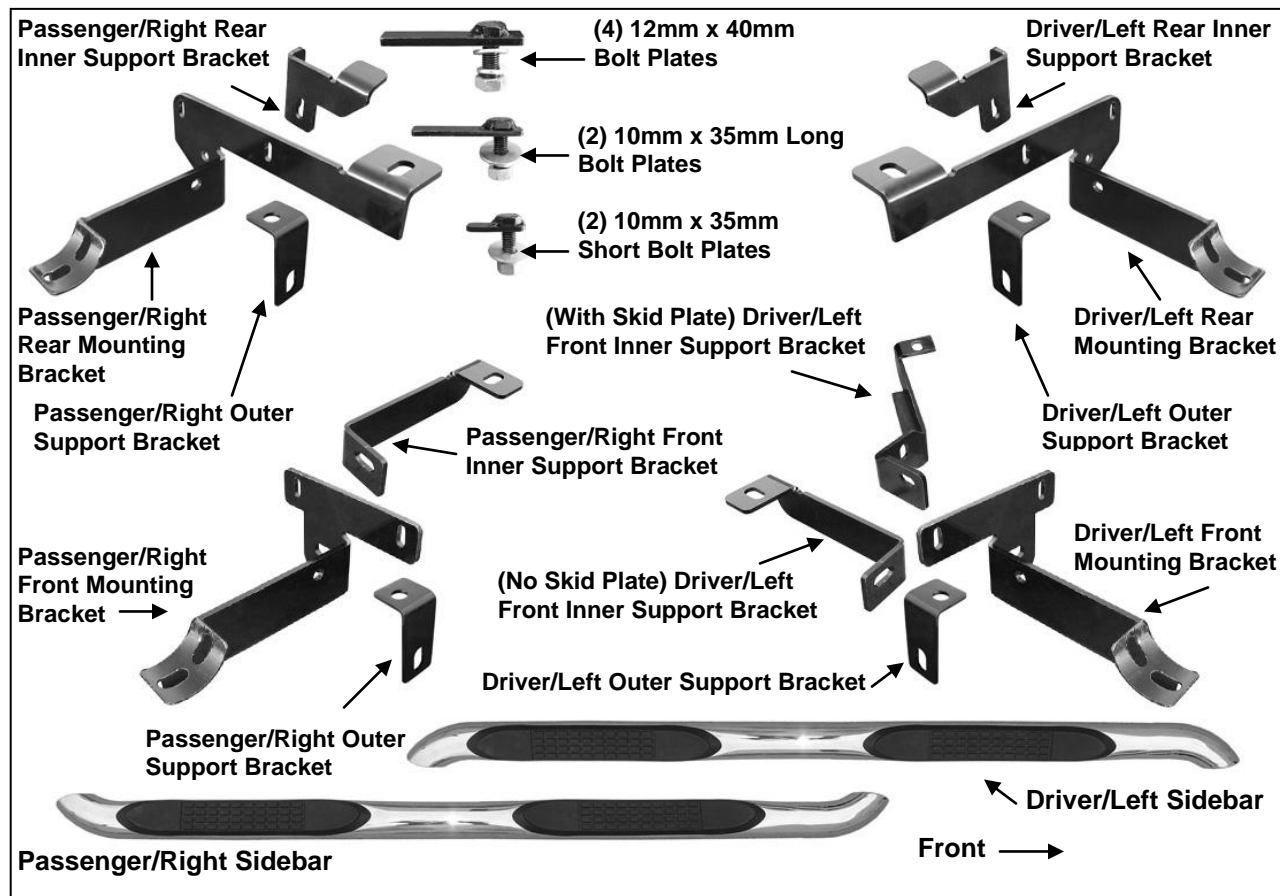

PROCEDURE:

1. **REMOVE CONTENTS FROM BOX. VERIFY ALL PARTS ARE PRESENT. READ INSTRUCTIONS CAREFULLY BEFORE STARTING INSTALLATION.**
2. Starting at the driver side front, remove the rubber plug filling the oval hole in the bottom of the rocker panel, **(Figure 1)**. Insert (1) 12mm x 40mm Bolt Plate into the hole and rotate 90-degrees to the slot, **(Figure 2A & 2B)**. **NOTE:** Repeat procedure for all Bolt Plate installations. Select (1) Driver Side Outer Support Bracket and secure it to the Bolt Plate with (1) 12mm Lock Washer, (1) 12mm x 24mm Small Flat Washer and (1) 12mm Hex Nut, **(Figure 3)**. Do not tighten hardware at this time.
3. Next, select the Driver Side Front Mounting Bracket. Bolt the Mounting Bracket to the back of the pinch weld with (2) 6mm x 25mm Hex Bolts, (4) 6mm Flat Washers and (2) 6mm Nylon Lock Nuts, **(Figure 4)**. Do not tighten hardware at this time.
4. Select the correct driver side Inner Support Bracket for your application, (see illustration on Page 1).
 - a. **For 2wd vehicles or 4WD without optional factory transfer case skid plate:** Locate the oval hole in the bottom of the frame channel. Insert (1) 10mm x 35mm Short Bolt Plate into the hole and rotate it 90-degrees, **(Figure 5A & 5B)**. Select the Driver Side Front Inner Support Bracket. Bolt the Bracket to the previously installed Bolt Plate with (1) 10mm Flat Washer, (1) 10mm Lock Washer and (1) 10mm Hex Nut, **(Figure 6)**. Line up the remaining hole in the Support Bracket with the hole in the center of the Front Mounting Bracket. Bolt the two Brackets together with (1) 12mm x 35mm Hex Bolt, (2) 12mm x 32mm OD Large Flat Washers, (1) 12mm Lock Washer and (1) 12mm Hex Nut, **(Figure 6)**. Line up the hole in the Outer Support Bracket with the hole in the Front Mounting Bracket. **Note:** The Outer Support Bracket will line up on the forward facing side of the Mounting Bracket. Bolt the two Brackets together with (1) 10mm x 30mm Hex Bolt, (2) 10mm Flat Washers and (1) 10mm Nylon Lock Nut, **(Figures 5A & 6)**. Do not tighten hardware at this time.
 - b. **For 4WD vehicles with optional transfer case skid plate. Step (b) applies to front driver side Inner Support Bracket installation only. Use Step (a) above for passenger side front Inner Support Bracket installation.** On the driver side, locate the hex bolt securing the rear of the skid plate to the bottom of the frame channel, **(Figure 7A)**. Remove the factory hex bolt. Select the Driver Side Front Inner Support Bracket for models **W/Factory Skid Plate**, **(Figure 7B)**. Place the Bracket over the skid plate and bolt it in place with (1) 10mm x 40mm Hex Bolt, (1) 10mm Flat Washer and (1) 10mm Lock Washer. Leave hardware loose at this time. Line up the (2) holes in the outer end of the Support Bracket with the holes in the Front Mounting Bracket. Line up the hole in the Outer Support Bracket, (See Step 1), with the hole in the Mounting Bracket and Support Bracket, **(Figure 7A)**. **Note:** The Outer Support Bracket will line up on the **rear facing** side of the Mounting Bracket, **(Figure 7B)**. Bolt the (3) Brackets together with (2) 10mm x 35mm Hex Bolts, (4) 10mm Flat Washers and (2) 10mm Nylon Lock Nuts. Do not tighten hardware at this time. **Note:** Use **Step (a)** above for passenger side Inner Support Bracket installation instructions for all vehicles.
5. Move to the driver side rear of the vehicle and remove the rubber plug in the bottom of the rocker panel as described in **Step 2**. Insert (1) 12mm Bolt Plate into the oval hole and rotate 90-degrees to the slot. Select (1) Driver Side Outer Support Bracket and secure it to the Bolt Plate with (1) 12mm Lock Washer, (1) 12mm x 20mm Small Flat Washer and (1) 12mm Hex Nut, **(Figure 8)**. Locate the oval hole in the floor panel on the other side of the pinch weld, forward of this location, **(Figure 9A)**. Insert (1) 10mm Large Bolt Plate into the hole and rotate 90-degrees to the oval hole, **(Figure 9B)**.
6. Next, select the Driver Side Rear Mounting Bracket. Bolt the Mounting Bracket to the back of the pinch weld with (2) 6mm x 25mm Hex Bolts, (4) 6mm Flat Washers and (2) 6mm Nylon Lock Nuts, **(Figure 10)**. Hang the Bracket from the previously installed forward Bolt Plate with (1) 10mm Flat Washer, (1) 10mm Lock Washer and (1) 10mm Hex Nut, **(Figure 10)**. Line up the hole in the Outer Support Bracket with the hole in the Mounting Bracket. Bolt the Brackets together with (1) 10mm x 30mm Hex Bolt, (2) 10mm Flat Washers, (1) 10mm Lock Washer and (1) 10mm Hex Nut, **(Figures 11 & 13)**.
7. Select the driver side Rear Inner Support Bracket. Bolt the Support Bracket to the back of the Mounting Bracket with (1) 10mm x 30mm Hex Bolt, (2) 10mm Flat Washers and (1) 10mm Nylon Lock Nut, **(Figures 11 & 12)**. Do not tighten hardware.

8. Select the left Sidebar and carefully place it in position on the (2) Mounting Brackets. Line up the threaded holes in the Sidebar with the slots in the Brackets and bolt it in place with the included (4) 8mm x 25mm Hex Bolts, (4) 8mm Lock Washers and (4) 8mm Flat Washers, **(Figure 13)**. Snug all hardware but do not tighten at this time.
9. Adjust and level the Sidebar and tighten all hardware. **IMPORTANT:** Firmly press the tab on the Rear Inner Support Bracket, **(Figures 11 & 12)**, up against the bottom of the body panel as you tighten the 10mm Hardware.
10. Repeat **Steps 2 - 9** for passenger/right Sidebar installation. **NOTE:** Use **Step (a)** above only.
11. Do periodic inspections to the installation to make sure that all hardware is secure and tight.

To protect your investment, wax this product after installing. Regular waxing is recommended to add a protective layer over the finish. Do not use any type of polish or wax that may contain abrasives that could damage the finish.

For stainless steel: Aluminum polish may be used to polish small scratches and scuffs on the finish. Mild soap may be used also to clean the Sidebar.

For gloss black finishes: Mild soap may be used to clean Sidebar.

Driver Side Installation Pictured

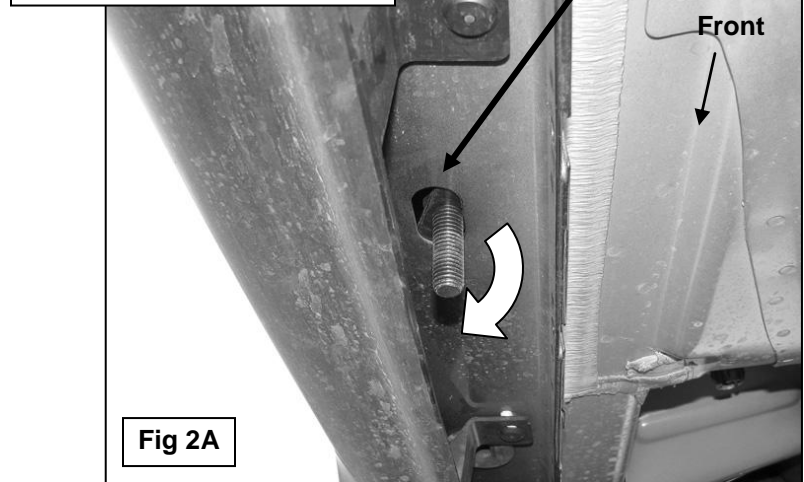
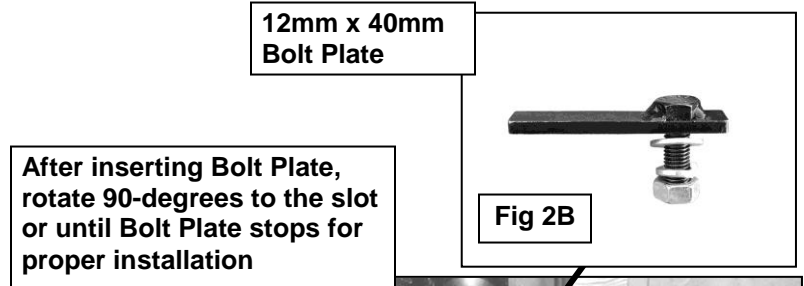
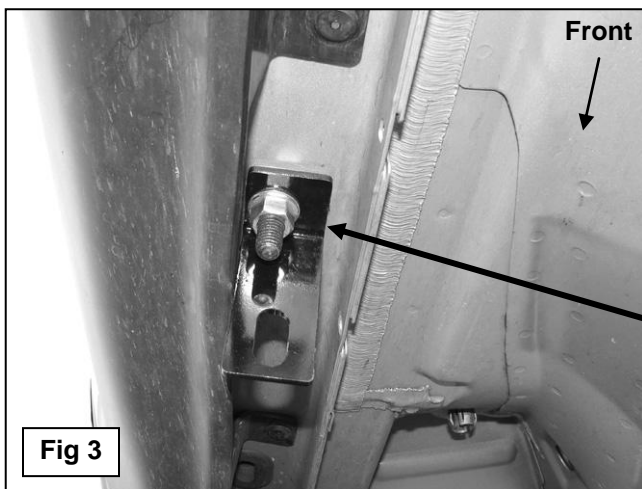
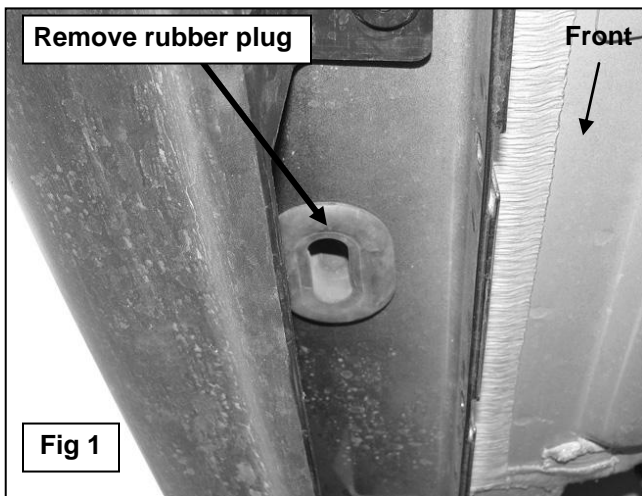

- Driver Side Outer Support Bracket**
- (1) 12mm x 40mm Bolt Plate
 - (1) 12mm x 24mm Small Flat Washer
 - (1) 12mm Lock Washer
 - (1) 12mm Hex Nut

Driver Side Installation Pictured

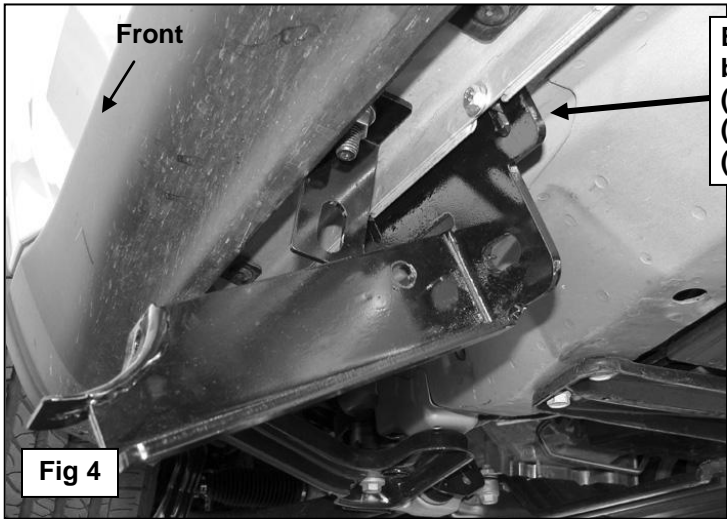

Bolt Mounting Bracket to back of pinch weld
(2) 6mm x 25mm Hex Bolts
(4) 6mm Flat Washers
(2) 6mm Nylon Lock Nut

10mm x 30mm Hex Bolt
(2) 10mm Flat Washers
10mm Lock Washer
10mm Hex Nut

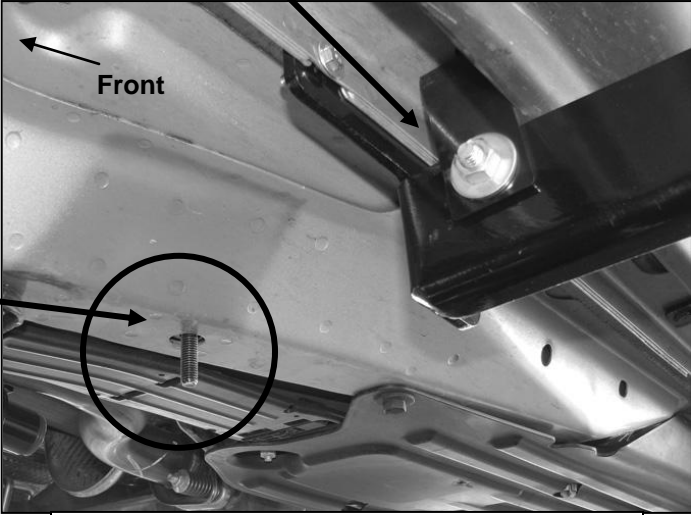

(Fig 5A) 2WD/Vehicles Without Transfer Case Skid Plate Only (Also applies to passenger side Support Bracket-all vehicles)

Insert Bolt Plates then rotate 90-degrees to the slot or until it stops for proper installation

10mm x 35mm Short Bolt Plate



(Fig 5B) 10mm x 35mm Short Bolt Plate pictured with:
10mm Flat Washer
10mm Lock Washer
10mm Hex Nut

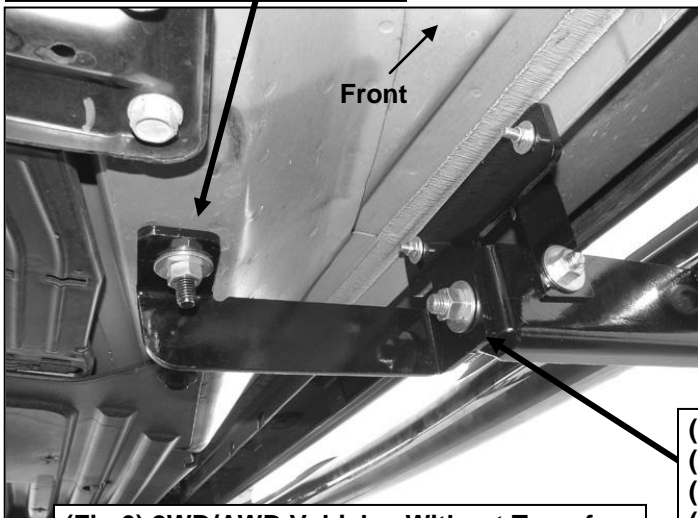

(1) 12mm x 35mm Hex Bolt
(2) 12mm x 32mm Large Flat Washers
(1) 12mm Lock Washer
(1) 12mm Hex Nut

(Fig 6) 2WD/AWD Vehicles Without Transfer Case Skid Plate Only (Also applies to passenger side Support Bracket-all vehicles)

Driver Side Installation Pictured

- (2) 10mm x 35mm Hex Bolts
- (4) 10mm Flat Washer
- (2) 10mm Nylon Lock Nuts

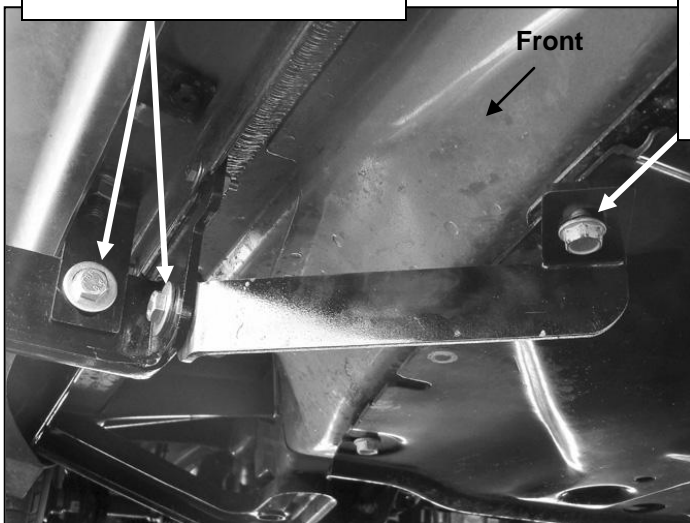

Replace factory hex bolt with:
10mm x 40mm Hex Bolt
10mm Lock Washer
10mm Flat Washer

(Fig 7A) Driver side Front Support Bracket Installation for 4WD Vehicles With Transfer Case Skid Plate Only. NOTE: Move Outer Support Bracket to back of Mounting Bracket

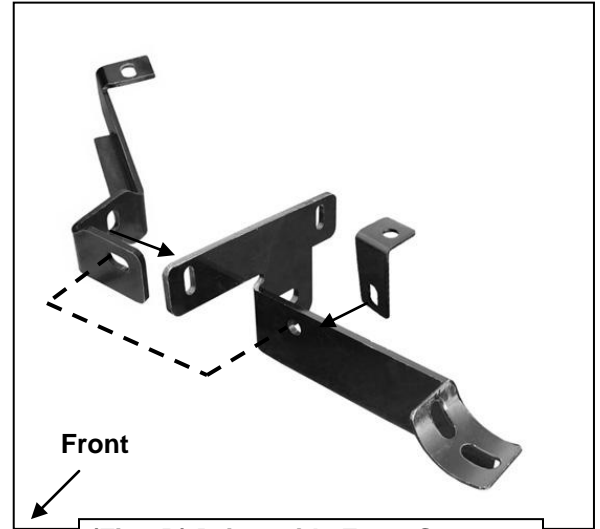

(Fig 7B) Driver side Front Support Bracket for 4WD Vehicles With Transfer Case Skid Plate Only

- Outer Support Bracket
- (1) 12mm x 40mm Bolt Plate
 - (1) 12mm x 24mm Small Flat Washer
 - (1) 12mm Lock Washer
 - (1) 12mm Hex Nut

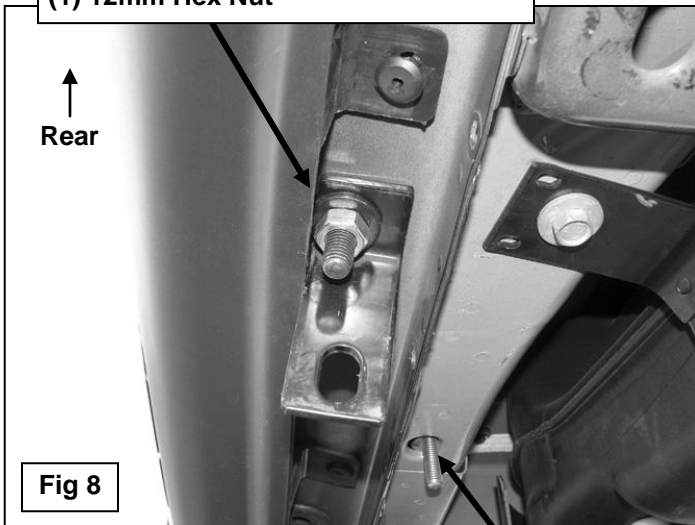

(Fig 8B) 10mm x 35mm Long Bolt Plate

After inserting, rotate Bolt Plate 90-degrees to the slot or until Bolt Plate stops for proper installation



Fig 9B

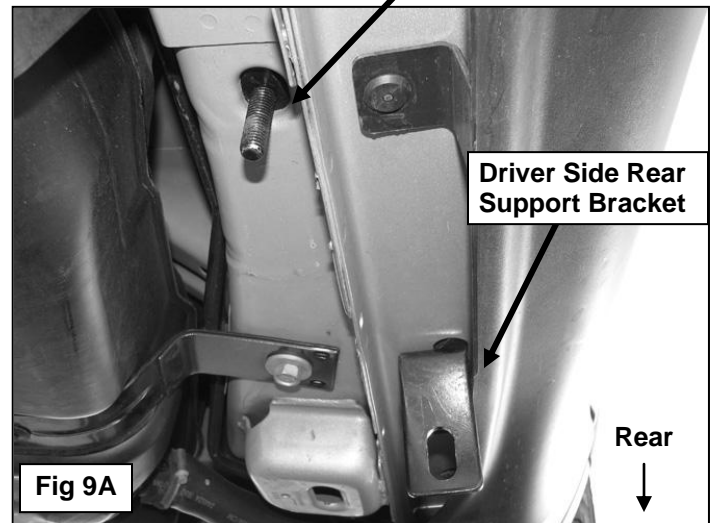

Driver Side Installation Pictured

10mm Flat Washer
10mm Lock Washer
10mm Hex Nut

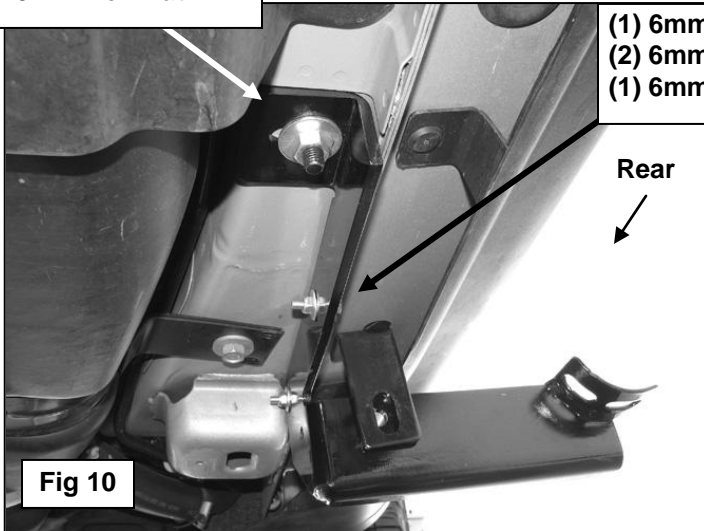

Fig 10

(1) 6mm x 25mm Hex Bolt
(2) 6mm Flat Washers
(1) 6mm Nylon Lock Nut

(1) 6mm x 25mm Hex Bolt
(2) 6mm Flat Washers
(1) 6mm Nylon Lock Nut

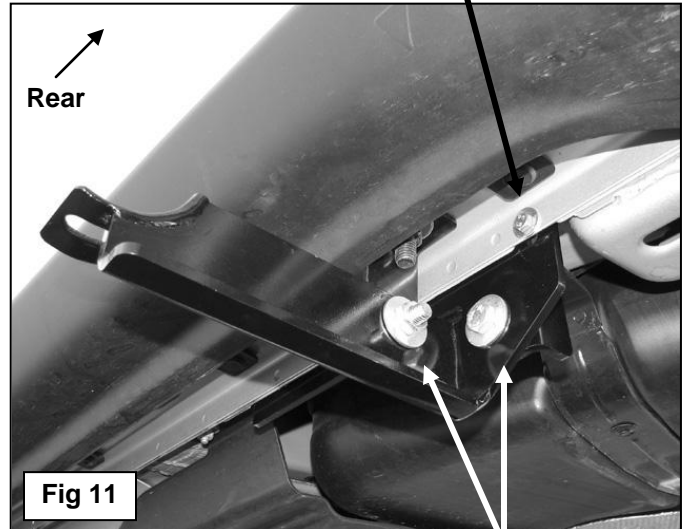
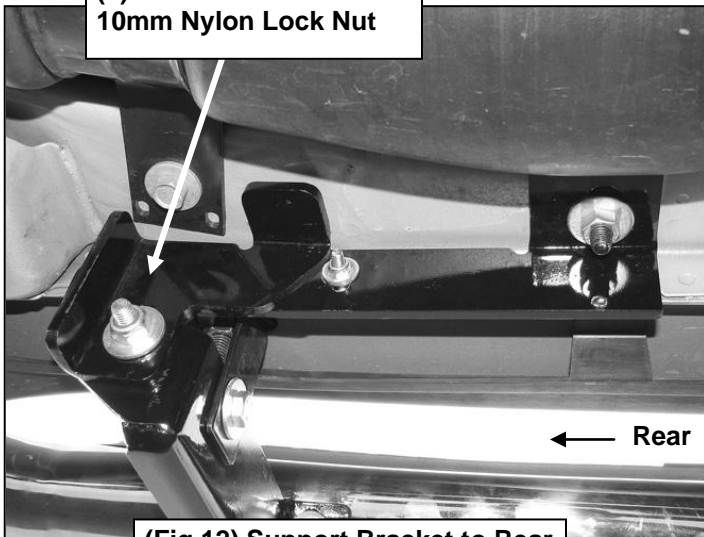

Fig 11

10mm x 30mm Hex Bolt
(2) 10mm Flat Washers
10mm Nylon Lock Nut



(Fig 12) Support Bracket to Rear Mounting Bracket Installation

10mm x 30mm Hex Bolt
(2) 10mm Flat Washers
10mm Lock Washer
10mm Hex Nut

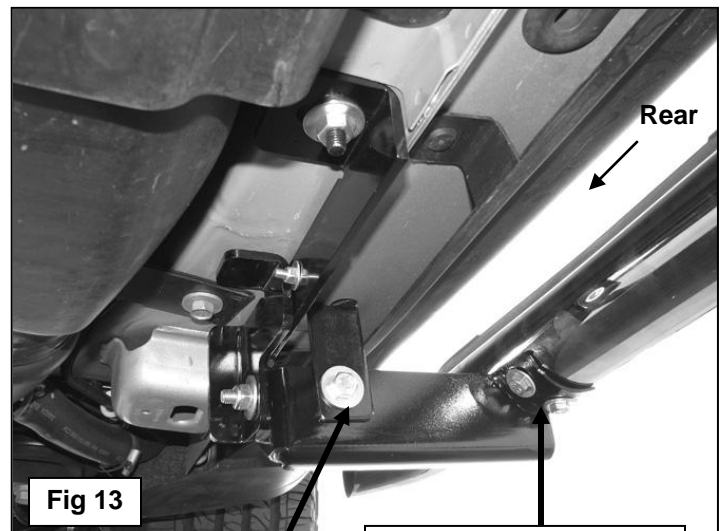

Fig 13

10mm x 30mm Hex Bolt
(2) 10mm Flat Washers
10mm Nylon Lock Nut

8mm x 25mm Hex Bolt
8mm Lock Washer
8mm Flat Washer



Complete Installation