

Intermediate Revol Manual

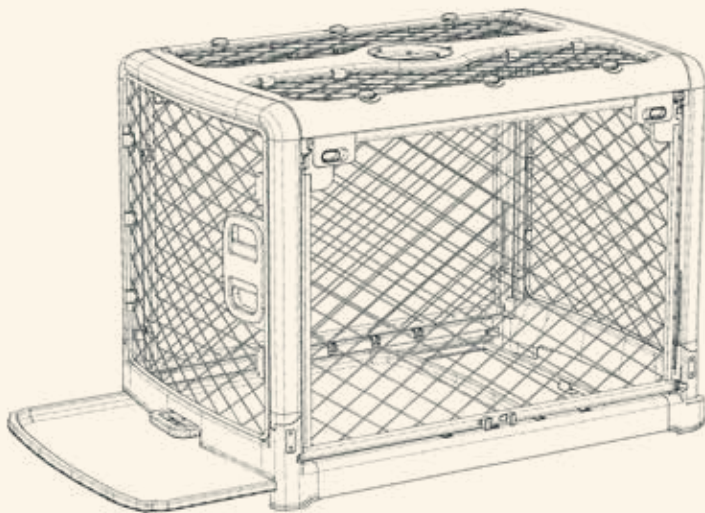

We recommend 2 people assemble the Intermediate Revol to avoid injury or damage



About Diggs

As pet parents ourselves, we care deeply about safety, great design, and solving real problems for both pets and their parents. We believe that dogs deserve homes that are as beautiful and safe as our own, so our products are inspired by baby industry quality standards.

**We hope your pup loves their
new Diggs!**

ALWAYS...

- ✓ Carry, roll, and otherwise transport the Crate only in the collapsed position
- ✓ Move the Crate only by grasping the Crate handles
- ✓ Lift, lower, and move the Crate in an unobstructed area and take care not to bump into walls or objects
- ✓ Roll the Crate by lifting from the rolling handle; ensure that the wheels at the back of the Crate engage with the floor
- ✓ Supervise children while they are around the Crate; do not let them climb inside or on top of the Crate
- ✓ Make sure that you are properly crate training your dog
- ✓ Follow all operation instructions and use the Crate only as recommended

❗ Head to our diggs.pet/resources for helpful how-to videos and e-books including our Ultimate Guide to Crate Training. There, you can also find a digital version of this manual.

NEVER...

- ✘ Let a dog bite or chew on any part of the Crate
- ✘ Climb on, stand/sit on, or sit inside the Crate for any reason
- ✘ Roll, carry, collapse, or otherwise transport the Crate while a dog is inside the Crate
- ✘ Transport the Crate in an automobile while a dog is inside the Crate
- ✘ Move the Crate by grasping the underside of the ceiling, base plate, or mesh
- ✘ Roll the Crate up or down steps, even without a dog inside
- ✘ Use the Crate on an elevated or any uneven surface
- ✘ Leave a dog unattended in the Crate outdoors under any circumstances
- ✘ Leave your dog in the Crate for long periods of time while crate training
- ✘ Never use the Crate as a form of punishment for a dog

Contents

- 1 Components
- 3 How To Assemble
- 19 Crate Doors
- 21 Puppy Divider
- 23 Raising the Crate
- 25 Lowering & Moving the Crate
- 27 Removing the Tray
- 29 Warning
- 29 Registration & Resources
- 30 Warranty

Components

Intermediate Revol Components

Make sure you have all of the following pieces before assembly:

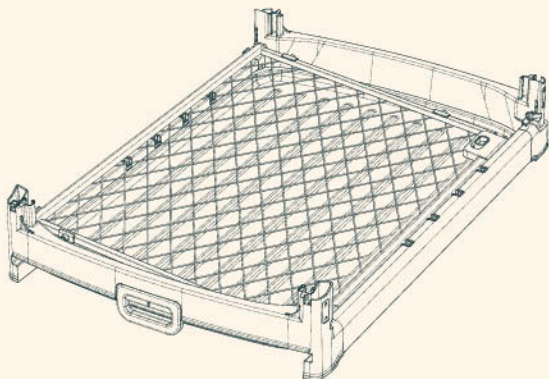

Base and Left Panel

Ceiling and Garage-Style
Side Door

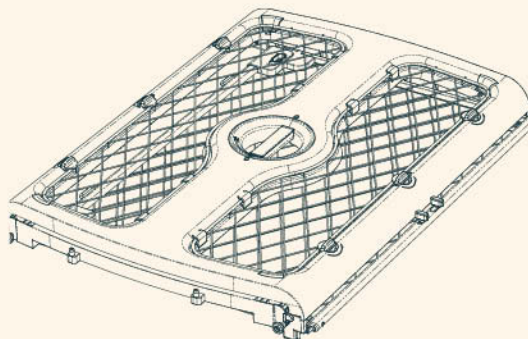

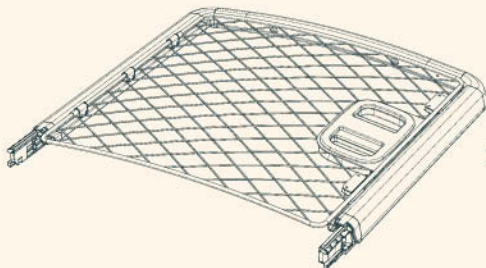

Front Door

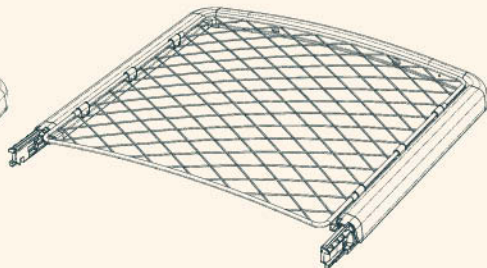

Back Panel

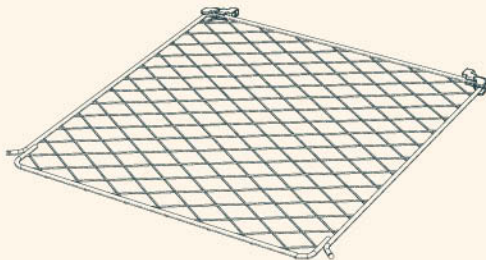

Puppy Divider

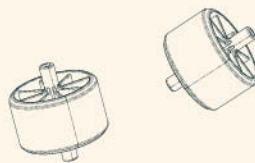

Wheels
Includes 2 wheels.

❶ If you are missing any of these parts, please contact Help@diggs.pet

How to Assemble

1. Installing the Wheels

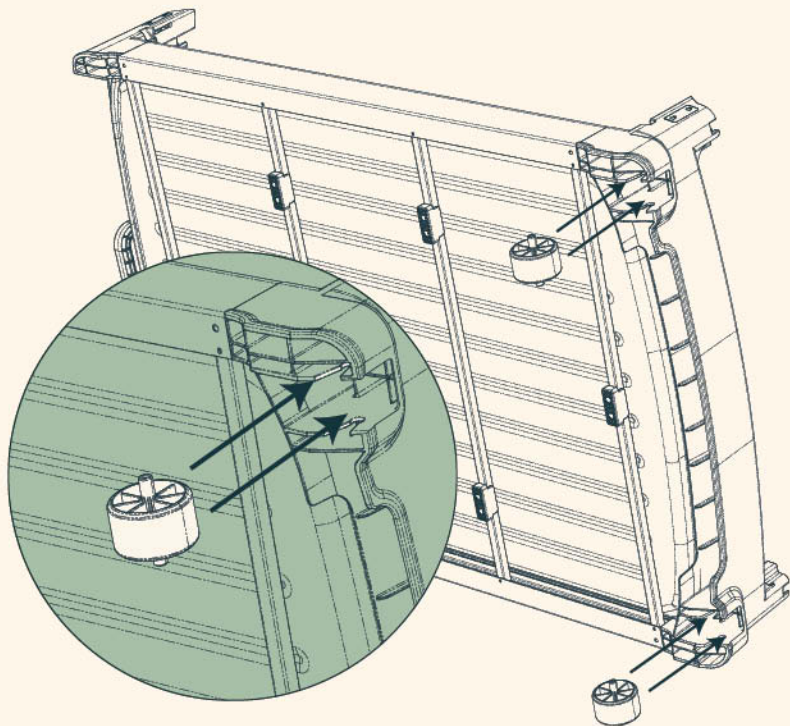

A. Insert a wheel into the back corner slot at the bottom of the base. Be mindful of moving parts as you rotate the crate.

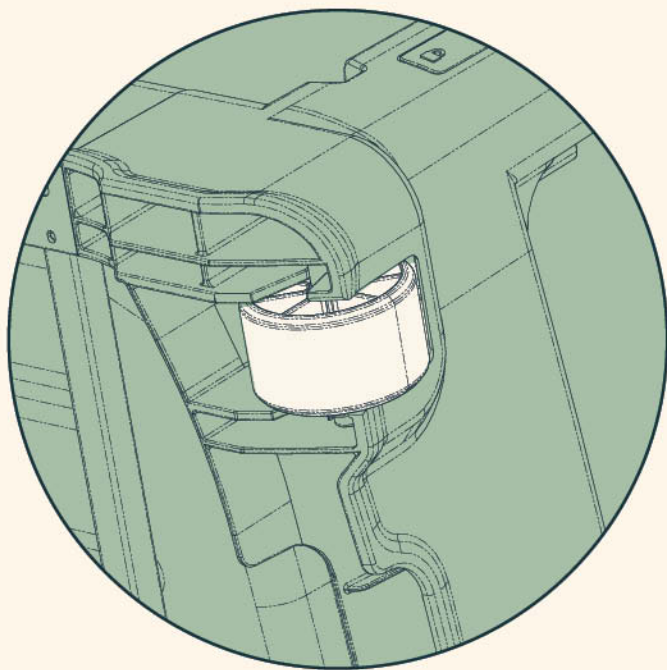

B. Press firmly until it snaps into place.

C. Repeat with the other wheel.

How to Assemble

2. Ceiling & Base Alignment

Ensure the ceiling and base are in the correct orientation before proceeding to the next step.

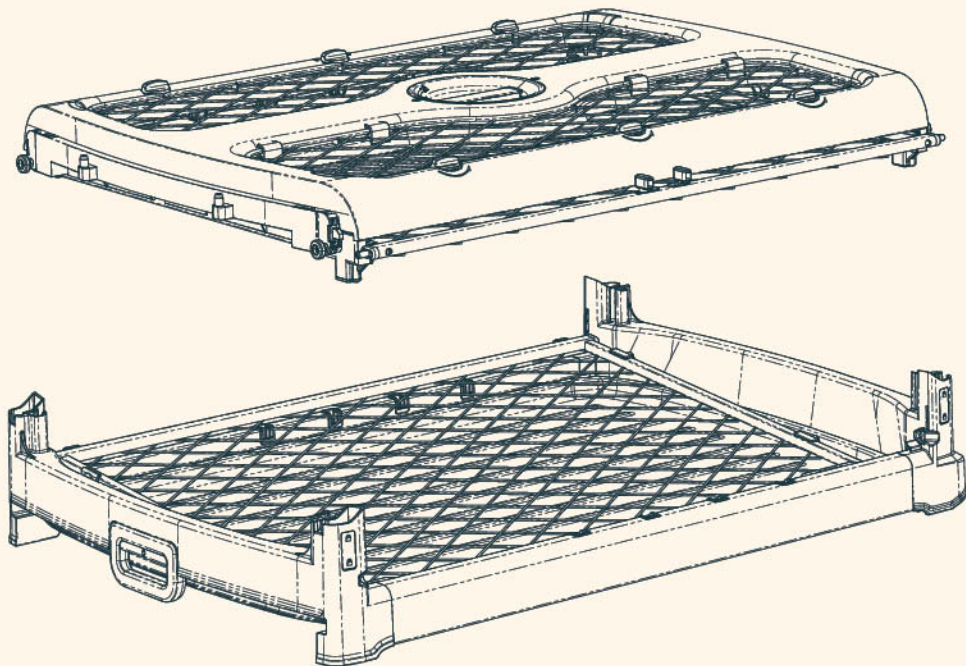

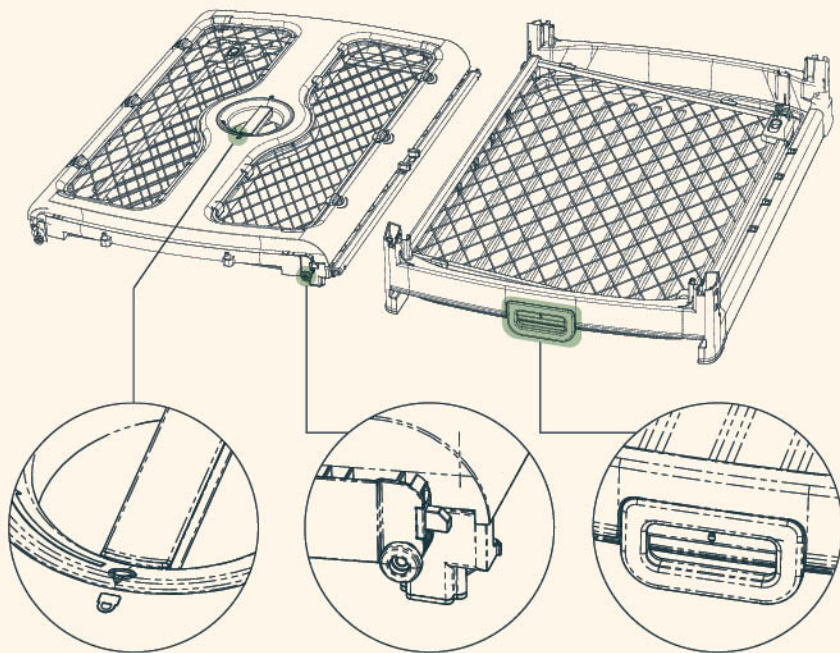

Handle lock icon

Grey wheel

Base handle/lock

A. On a flat surface, place the ceiling and base next to each other in the correct orientation. Ensure all three elements shown above are facing the same direction.

How to Assemble

3. Ceiling & Base Assembly

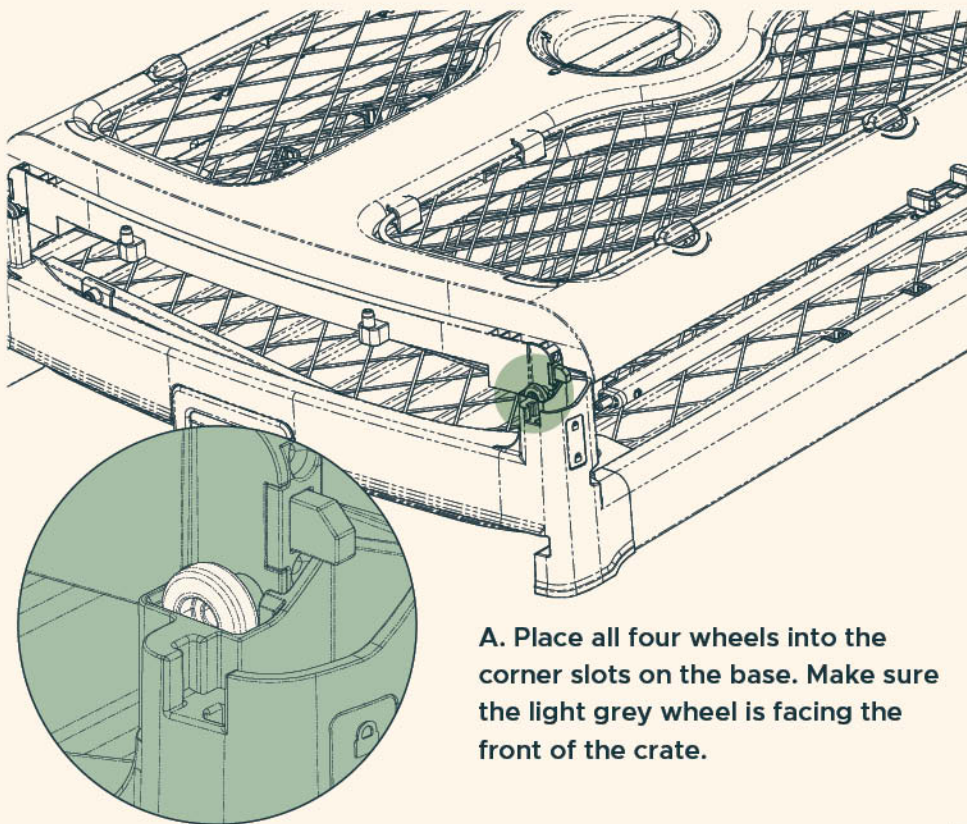

A. Place all four wheels into the corner slots on the base. Make sure the light grey wheel is facing the front of the crate.

B. Turn the top handle lock to quarter turn to drop the ceiling wheels to the bottom of the slots. Ensure each wheel is properly aligned and pushed down fully.

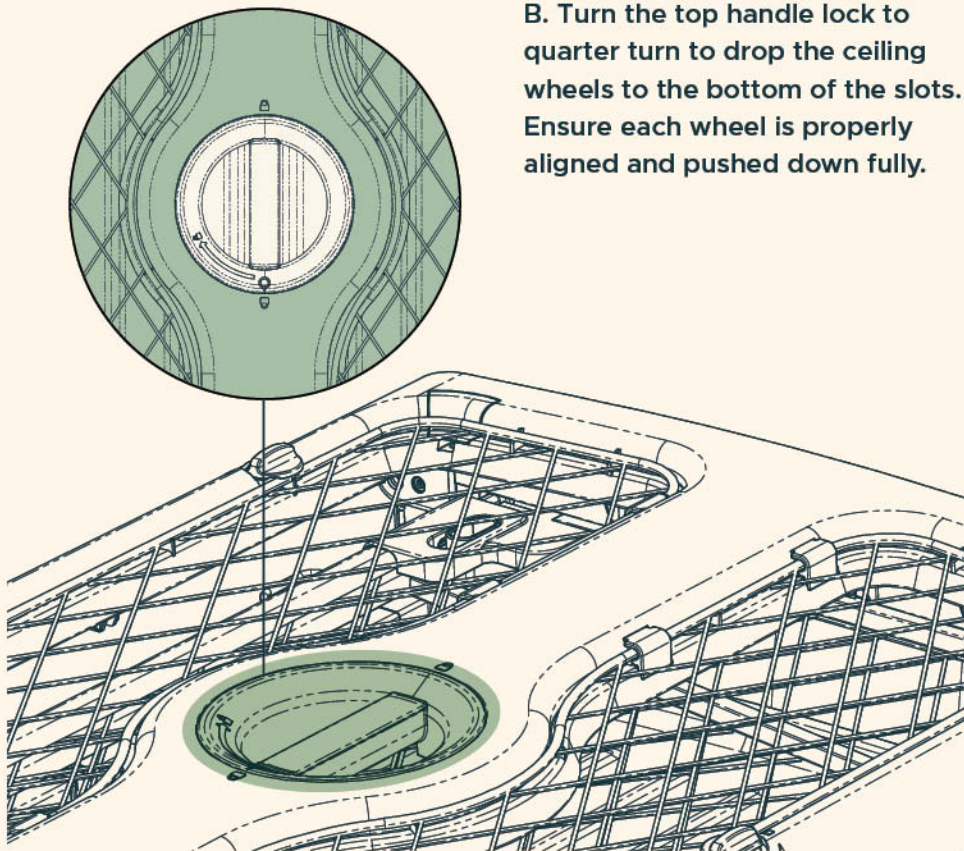

How to Assemble

3. Front Door & Back Panel Installation

A. Insert front door (with handle) into the front of the base.

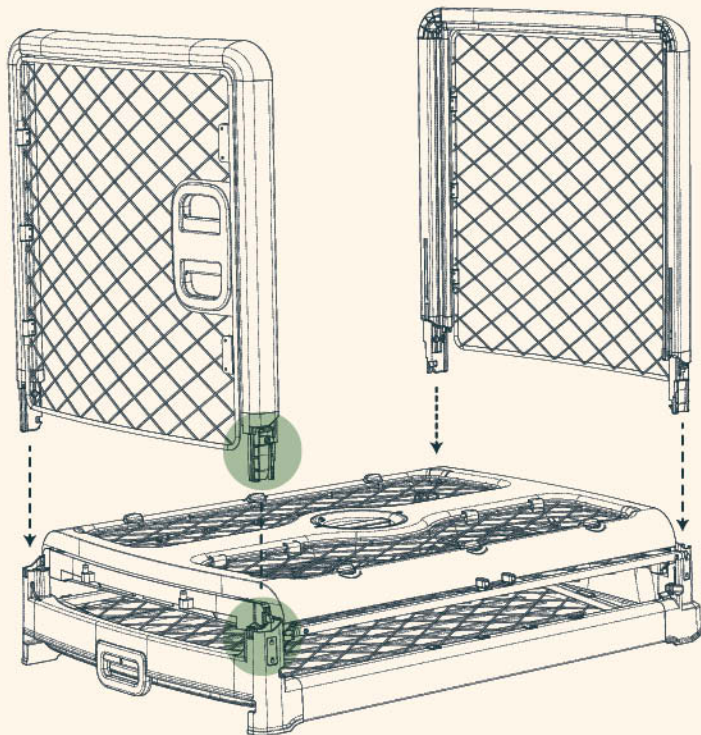

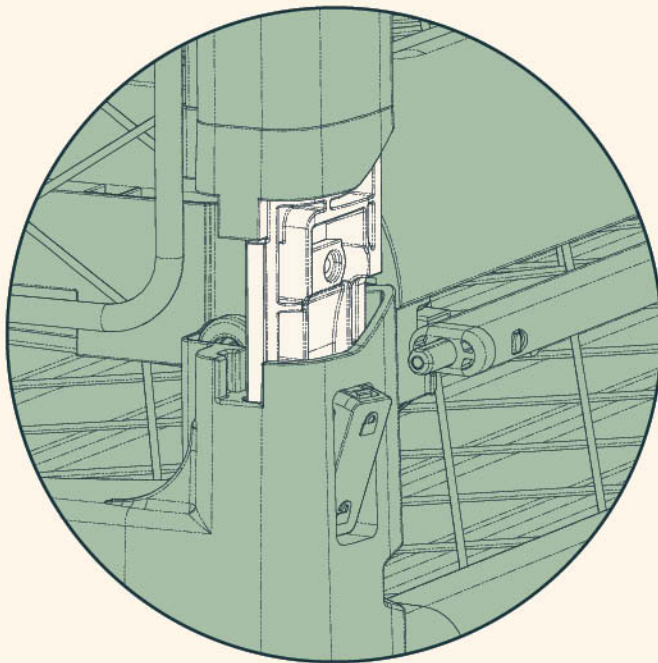

B. Insert back door into the back of the base.

How to Assemble

4. Locking the Panels

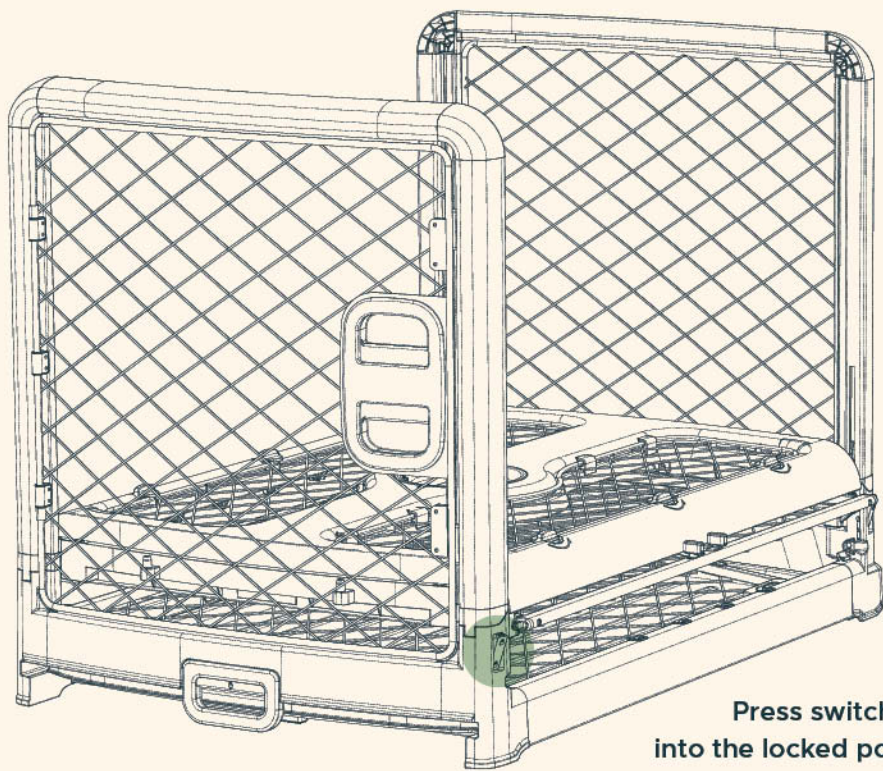

**Press switch locks
into the locked position.**

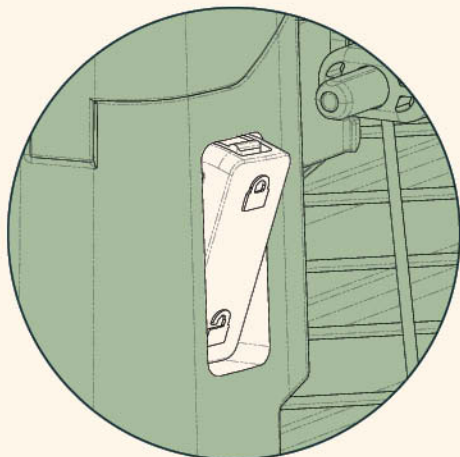

Press to Lock

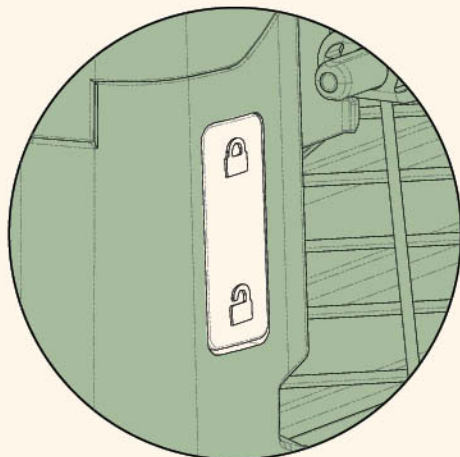

Locked

How to Assemble

5. Raising the Ceiling

Gently lift ceiling until it is fully raised; it will auto-lock into place.

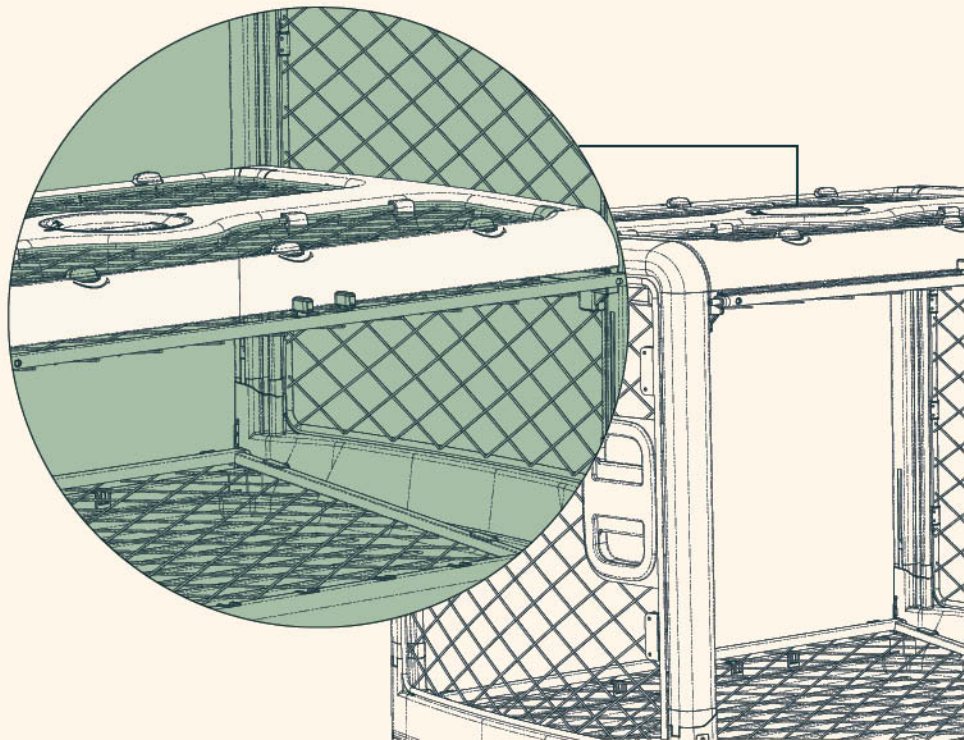

Fully raised ceiling

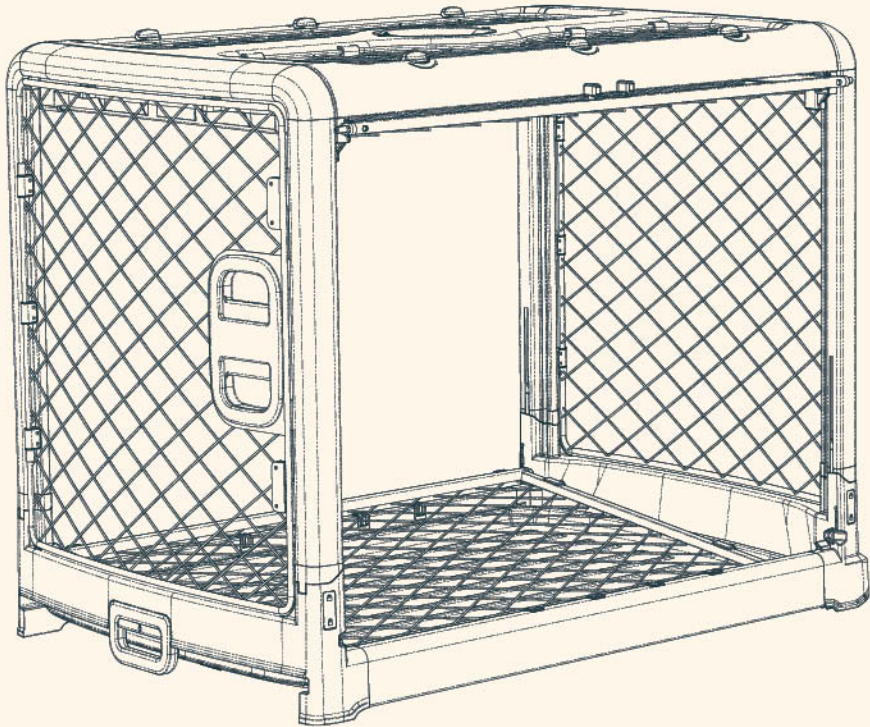

How to Assemble

6. Close the Garage-Style Side Door

A. Pull the door out fully from the ceiling pocket and gently lower.

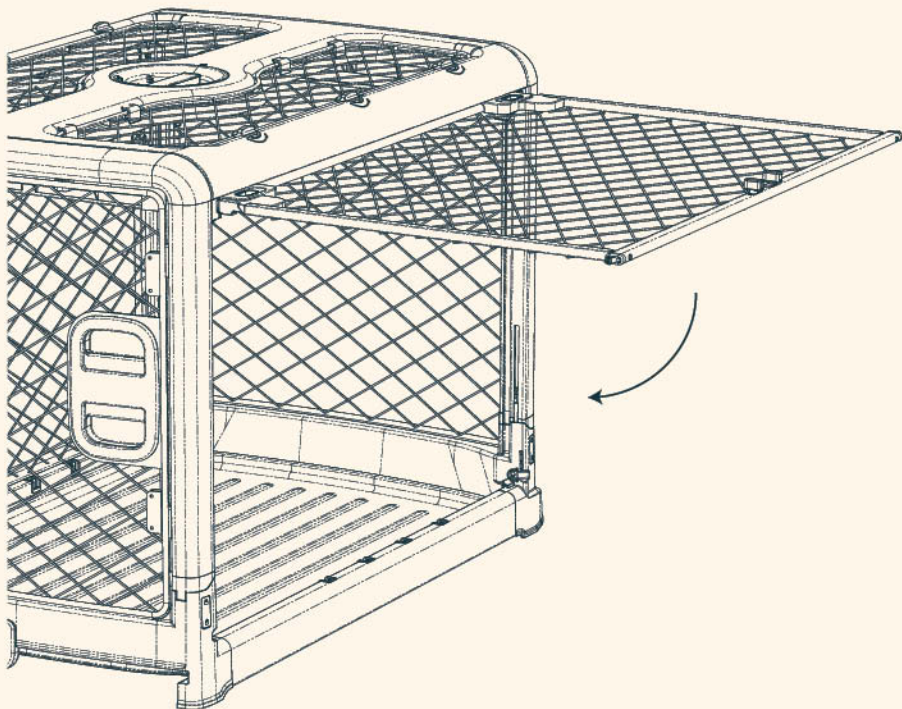

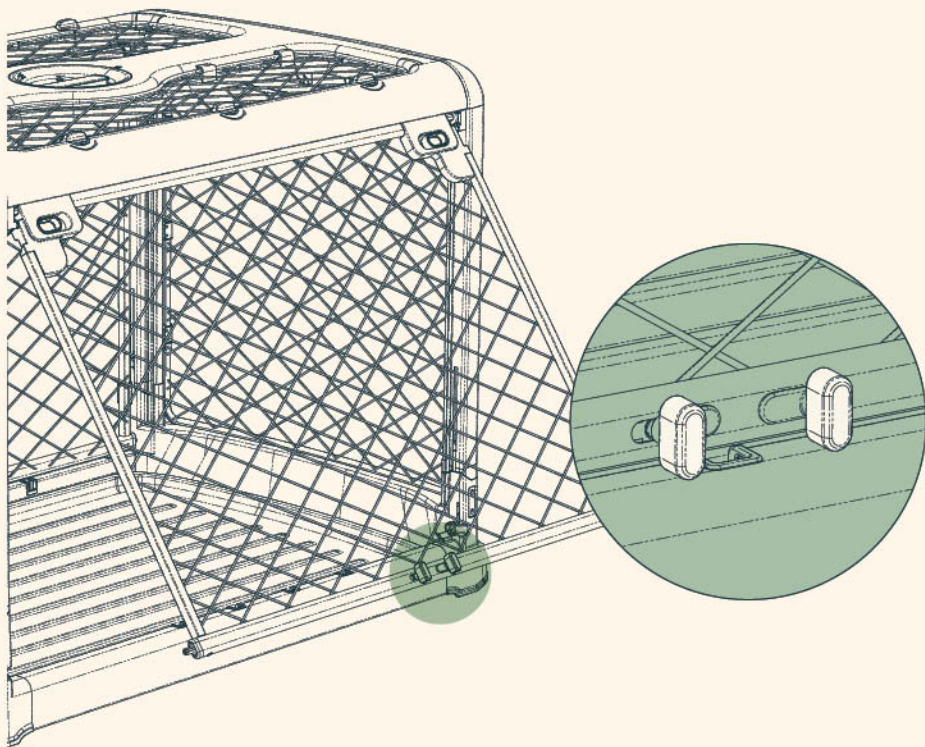

B. Squeeze the latches and swing the bottom of the door into the base. When the latches are released, the pins will click into place.

How to Assemble

7. Raise the Side Panel

A. Slide both the left and right top locks inward.

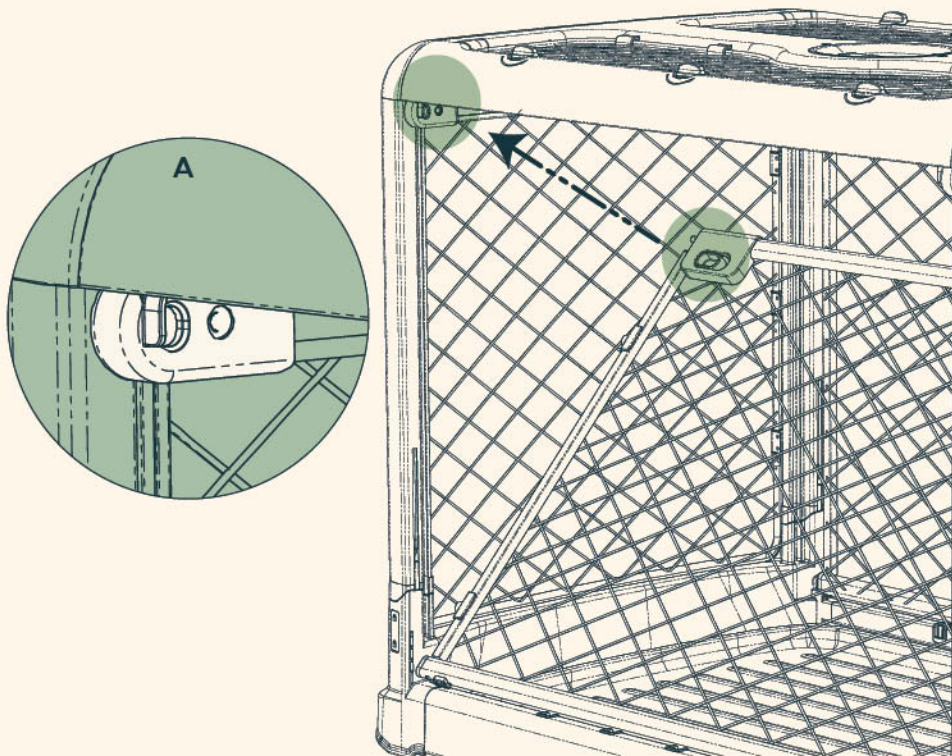

B. Rotate the side panel up until the locking pins are aligned with the ceiling, and depress sliders to release.

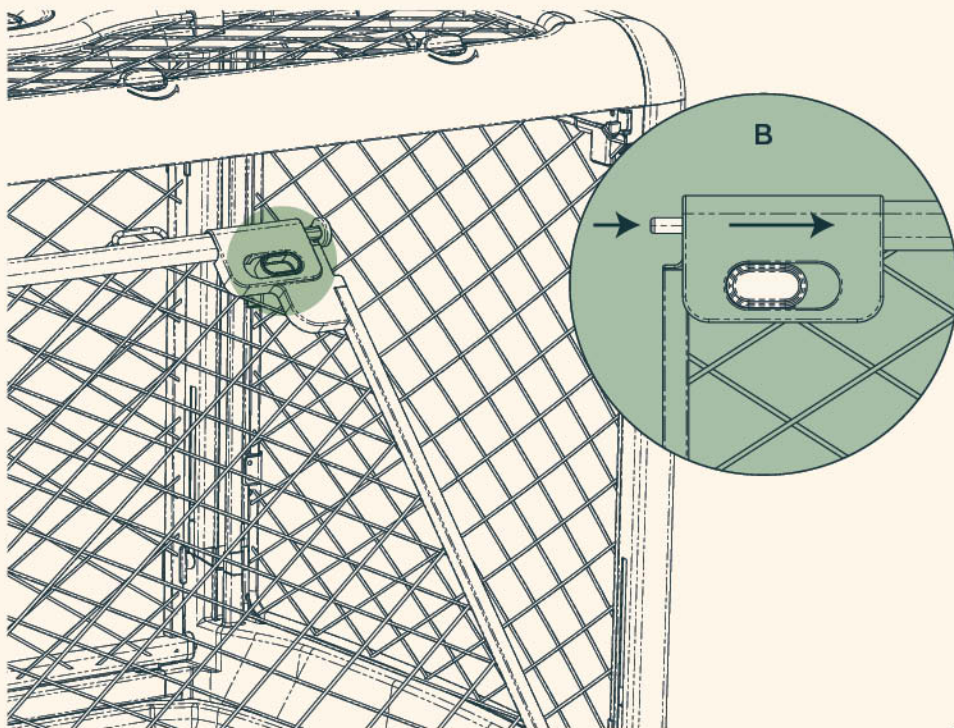

Crate Doors

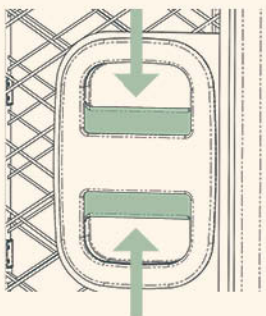

Front Door

To open:

Squeeze both sides of the front door handle and swing door out.

To close:

Squeeze both sides of the front door handle and press door in until it clicks into place. Pull on mesh firmly to ensure the door is secure.

Intermediate Garage-Style Side Door

To open:

Squeeze latches together and swing door out until parallel with floor.

Push the door on its tracks until it is fully under ceiling.

To close:

Pull door out from under ceiling. Squeeze latches together while lowering the door back into place. Pull door firmly to ensure it is secured.

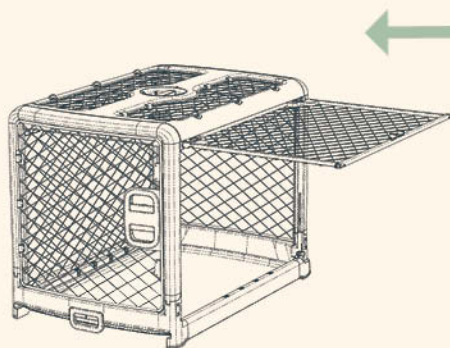
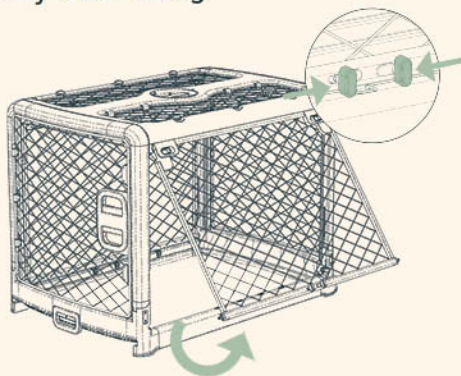

Ceiling Hatch

To open:

Turn all three ceiling hatch locks 180 degrees and pull door upwards.

To close:

Lower the hatch door back into place and return all three ceiling hatch locks to their initial position. Pull door firmly to ensure it is secured.

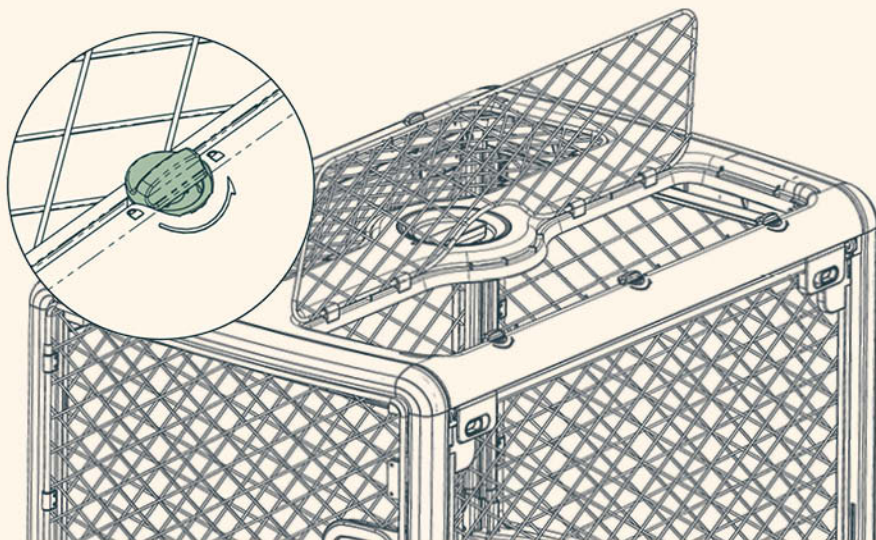
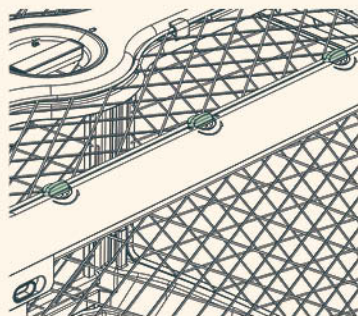

Puppy Divider

To Insert Puppy Divider

1. Open the ceiling hatch and carefully lower the divider into the Crate.
2. Rotate the divider until it is parallel with the front door and perpendicular to the side door.
3. Locate the divider tabs at the top of the Crate ceiling.

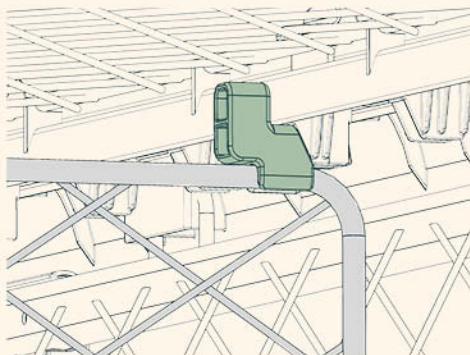

4. Once you've gently slid the divider into the tabs on the top of the ceiling, ensure that the bottom of the divider is inserted into the appropriate pair of base holes (depending on how much space your pup needs).

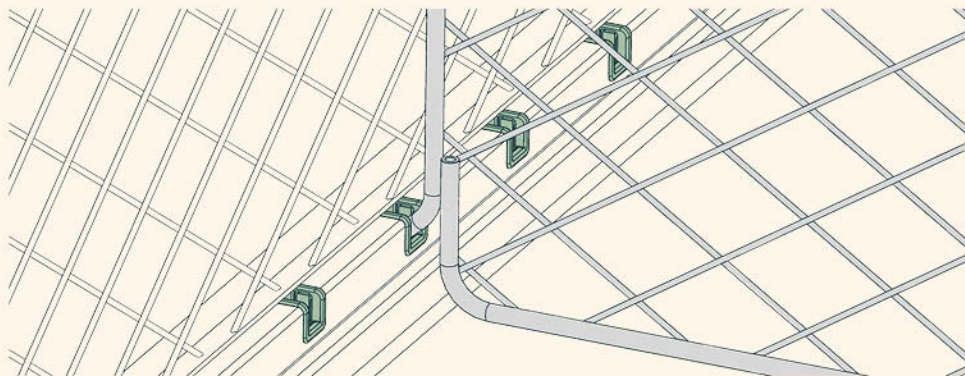

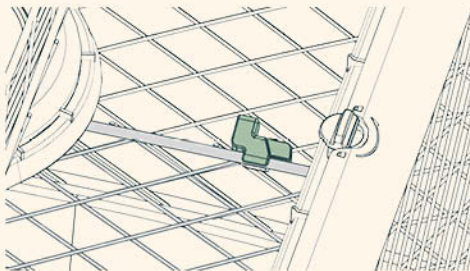

5. Rotate both of the divider locks (on the top of the divider) 90 degrees.

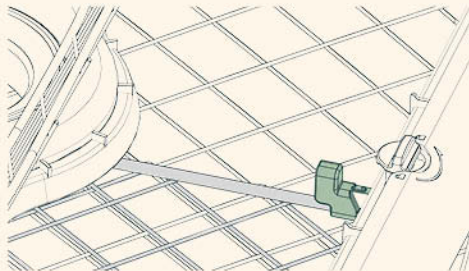

6. Push the divider lock towards the outside of the crate until you feel some resistance.

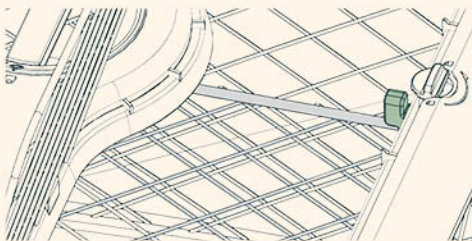

7. Rotate the lock until it's upright, then push it all the way in.

To Remove or Relocate Puppy Divider

1. Open the ceiling hatch.
2. Pull the divider locks towards the center of the crate one at a time until both are free from the ceiling.
3. Lift the divider up until it is out of the base holes, then tilt the divider down until the top is free of the ceiling locks.
4. Reinstall the divider to the desired new position or remove it entirely if no longer needed.

i Puppy divider and Snooz (sold separately) must be removed before opening garage-style side door

Raising The Crate

1 2 person lift recommended

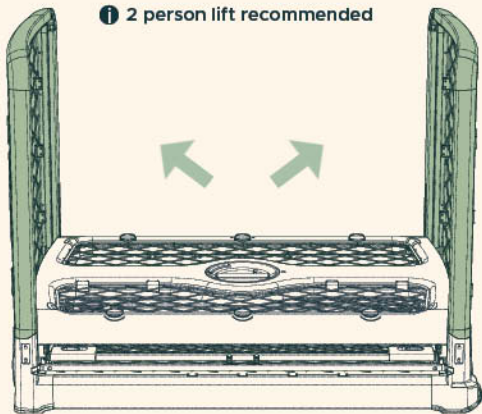

1. Lift front and rear doors until they are fully upright.

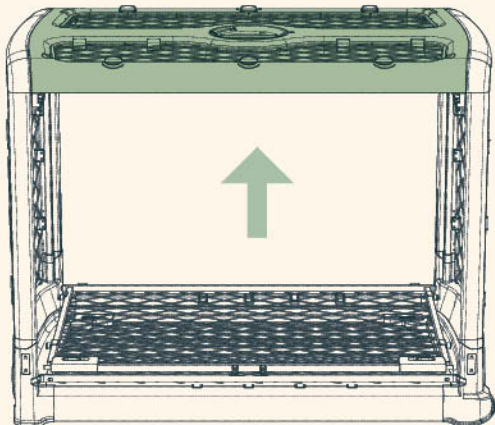

2. Using the ceiling handle, lift the ceiling up until the auto-lock clicks.

3. Lift the side panels one at a time gripping the top locks until the panels click into place.

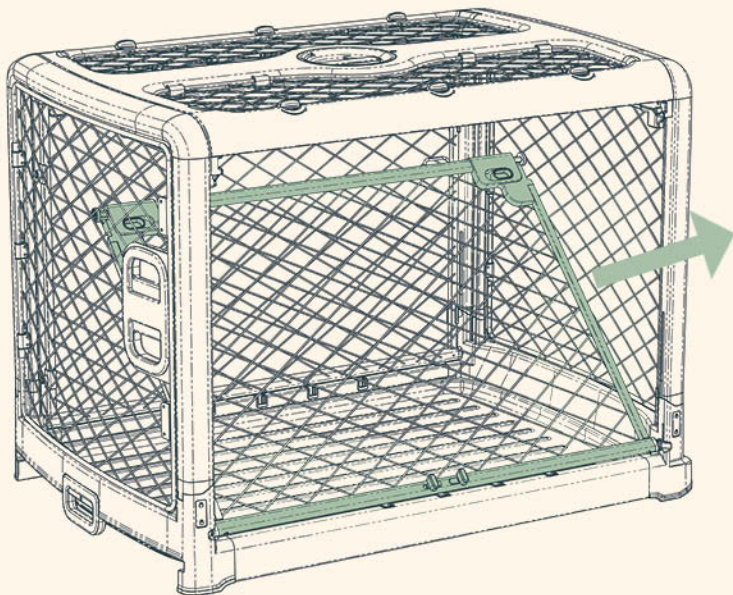

Lowering & Moving the Crate

To lower the crate

1. Ensure the puppy divider is removed.
2. Carefully unlock the top locks on the side panels and lower one at a time to their collapsed positions.
3. Rotate the ceiling handle clockwise and gently lower the ceiling to the base of the crate.
4. Lower front and back panels individually to their collapsed positions.

To transport the crate

1. Ensure the Crate is fully collapsed.
2. Lift the Crate using the rolling handle until the wheels engage with the floor.
3. Roll the Crate over short distances only.
4. At the desired location, slowly lower the front of the Crate to the floor.

i 2 person lift recommended

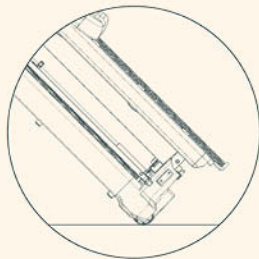
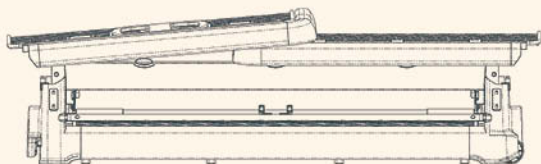

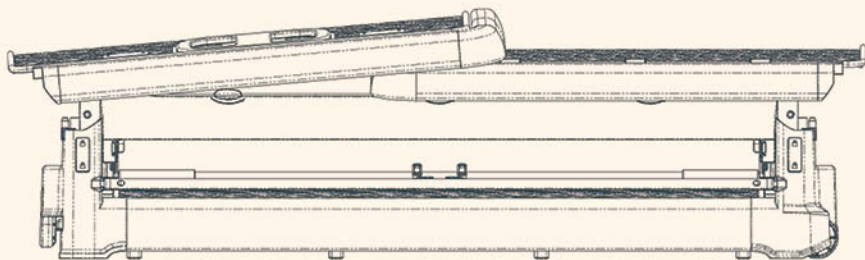

i Collapse the Crate into the nested position (shown above) before rolling

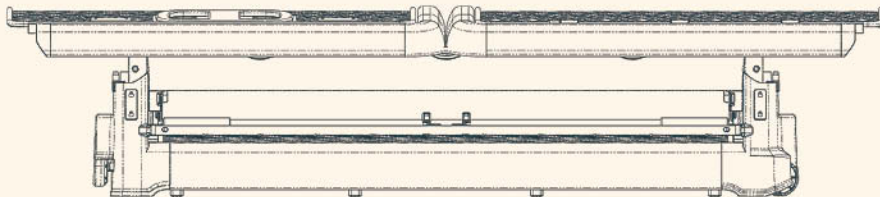

i To collapse the Crate into the flat position, pull the front and back panels outwards until they are flush with the base of the Crate (shown above)

Removing The Tray

1. Pull the rolling handle / tray lock down and outwards to release from the Crate.
2. Pull removable tray out from its slot and clean using gentle household cleaners only.
3. After cleaning, reinsert the tray into the slot and replace tray lock.

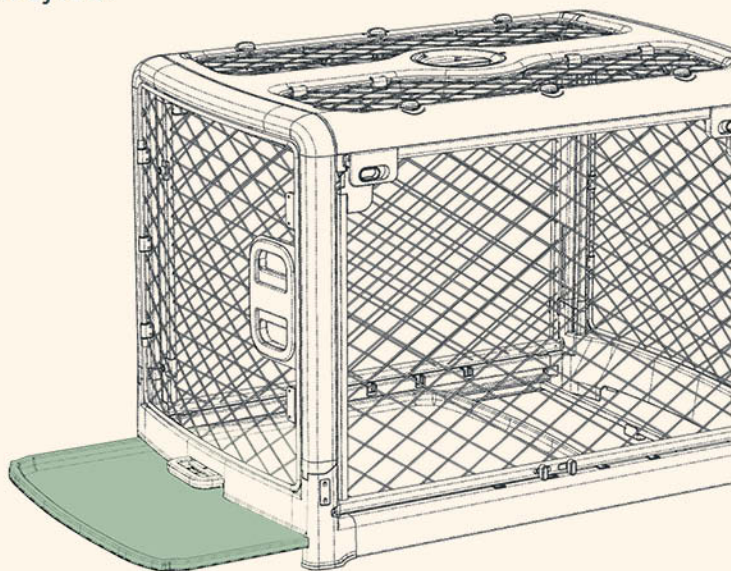

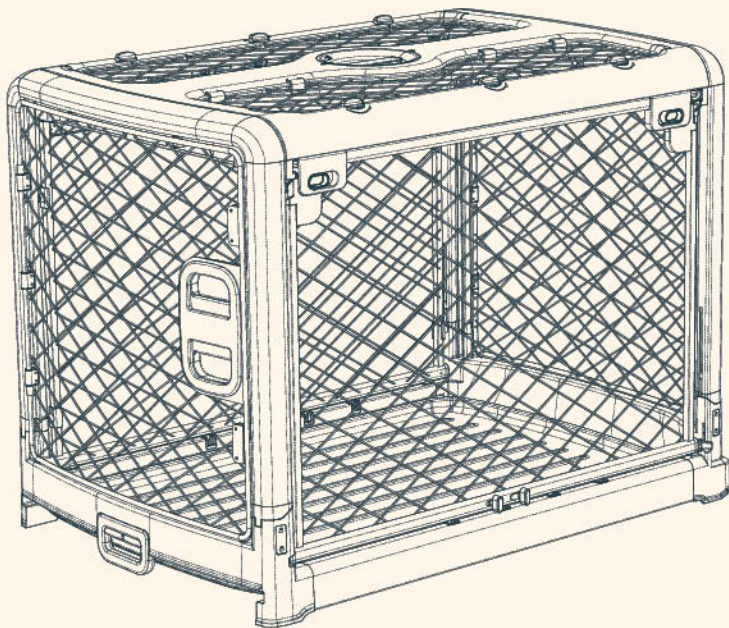

The Crate is very stable when properly assembled. If the Crate seems unstable or you have any questions, please reach out to help@diggs.pet before use.

Warning

Failure to follow these warnings and instructions could result in serious injury or death. Read all instructions before assembly or use of your Revol Crate (the “Crate”). Do not use the Crate if it is damaged or broken.

Always fully engage all locks on the ceiling hatch. Ensure that the front and side doors are securely locked.

Children should never enter the Crate. Children must not operate the Crate without adult supervision.

Always remove the dog’s collar, harness, tags, and leash before allowing the dog in the Crate.

For their safety, dogs should undergo thorough crate training. During this training period, closely monitor your dog when they are in the Crate.

Registration & Resource

If through some unforeseen circumstance Diggs Inc. needs to issue a product recall, we ask that you please register your Revol Crate. You may do this by registering online at <https://www.diggs.pet/registration>.

Head to our [diggs.pet/resources](https://www.diggs.pet/resources) for helpful how-to videos and e-books including our **Ultimate Guide to Crate Training**. There, you can also find a digital version of this manual.

Warranty

Diggs Inc. warrants to the original purchaser of every Revol Crate (“Crate”) that the unit will be free of defects in materials and workmanship under normal use for 1 year from the date of original purchase, with the exceptions stated below.

Diggs Inc. will repair any Crate that proves to be defective in materials or workmanship. In the event repair is not possible, or if Diggs Inc. otherwise thinks necessary, Diggs Inc. either will replace your Crate with a new Crate of similar composition and price or refund the full purchase price of your Crate.

This warranty expressly excludes any defects or damages caused by accessories, replacement parts, modification, or repair service other than those that have been authorized by Diggs Inc.. This warranty does not cover any damage caused by accident, misuse, shipment, or other than ordinary use. This warranty does not cover damage caused by dogs who are not Crate trained or who are improperly Crate trained, including damage caused by biting or chewing on the Crate. This warranty does not cover fading or discoloration by exposure to sunlight or chemicals. For information on how to prevent fading or discoloration, consult the instruction manual included with the Crate.

This warranty excludes all incidental or consequential damages. Some jurisdictions do not allow the exclusion or limitation of these damages, so these exclusions may not apply to you.

To request service or obtain additional warranty information, contact Diggs Inc. at info@diggs.pet. A service representative will instruct you on any necessary action required to correct problems covered by this warranty.

This warranty gives you specific legal rights, and you may also have other rights that vary from jurisdiction to jurisdiction.