

Evolv Modern Dog Crate

User Manual

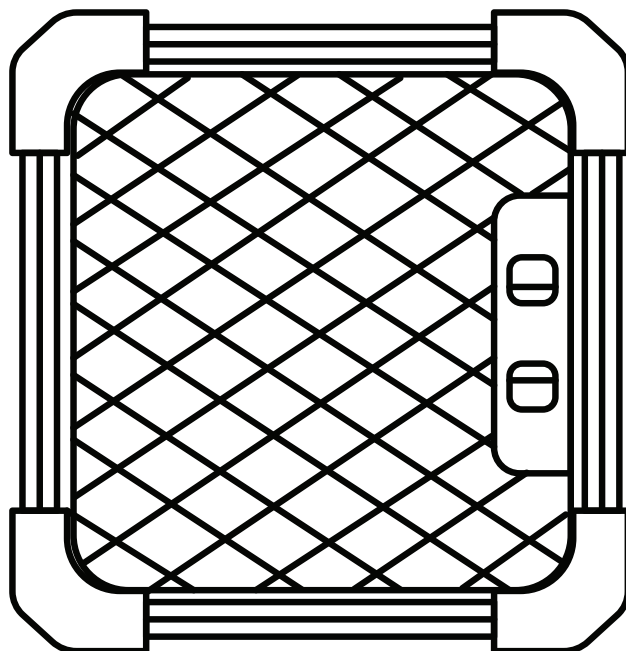

1.0 Components

2.0 Assembly Instructions

3.0 Crate Doors

4.0 Puppy Divider

5.0 Removing the Tray

6.0 Disassembly Instruction

7.0 Troubleshooting

8.0 Warnings

9.0 Registration & Resources

10.0 Warranty

1.0 Components

Components:



Front Door Panel



Side Door Panel



Side Wall Panel



Back Wall Panel



Base Frame



Ceiling Panel



Puppy Divider



Tray



**Bottom Corner
Connectors (4)**



**Top Corner
Connectors (4)**

2.0 Assembly Instructions

 [Video: How to Assemble](#)

After you unpack your crate, be sure to keep the box and all packing materials in case you need to make a return. Re-packing instructions can be found at [Re-packing Instructions](#).

For your convenience, we recommend assembling the Evolv in the location you plan to place it.

- 1** Before beginning assembly, determine your preferred orientation for the front door and side door (option A or option B). Please note that the door handles must meet at the same corner of the crate.

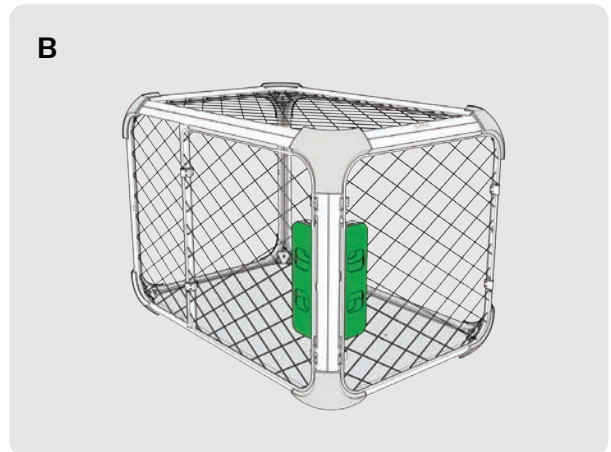
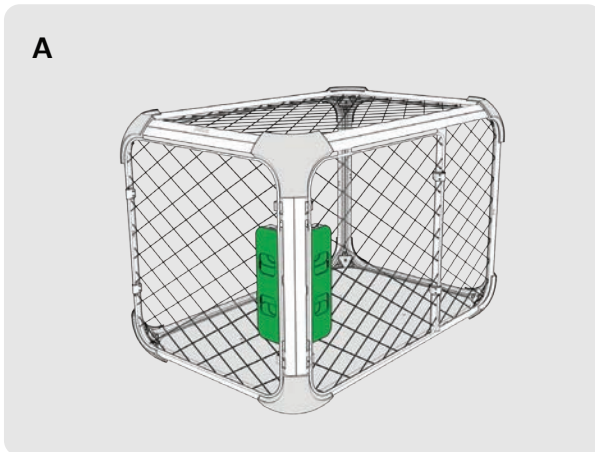

2.0 Assembly Instructions

- 2** For the first few steps of assembly, you will be assembling the crate upside-down. Arrange the front and side door panels based on your preferred orientation option:

For **option A**, stand the panels on the floor so that the door handles meet at the **LEFT side** of the crate.

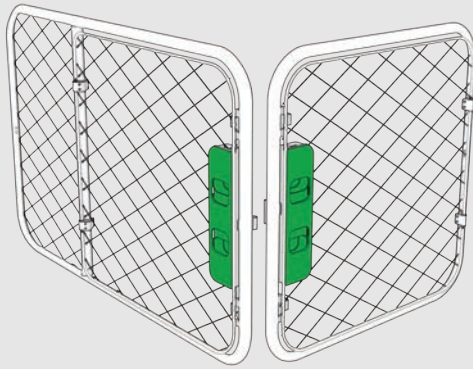

For **option B** stand the panels on the floor so that the door handles meet at the **RIGHT side** of the crate.

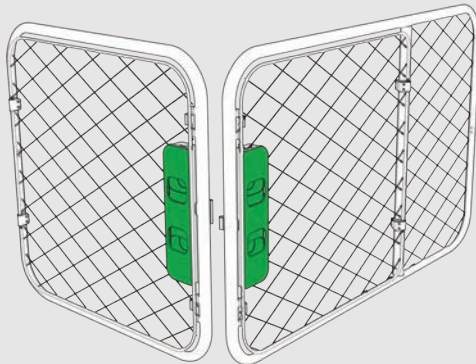

2.0 Assembly Instructions

- 3** Slide the post and hole features together to connect the front and side door panels.

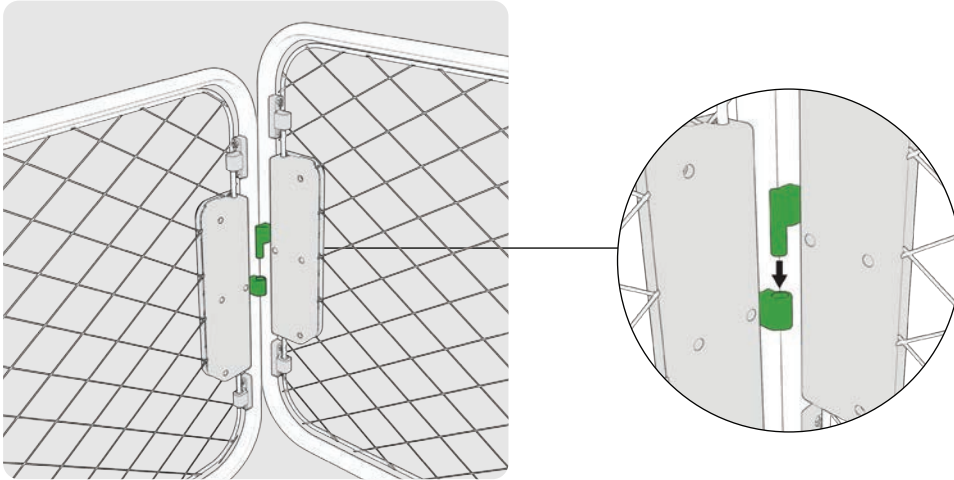

- 4** Connect the remaining side wall and back wall panels using the post and hole features until all 4 sides are connected and standing on the floor.

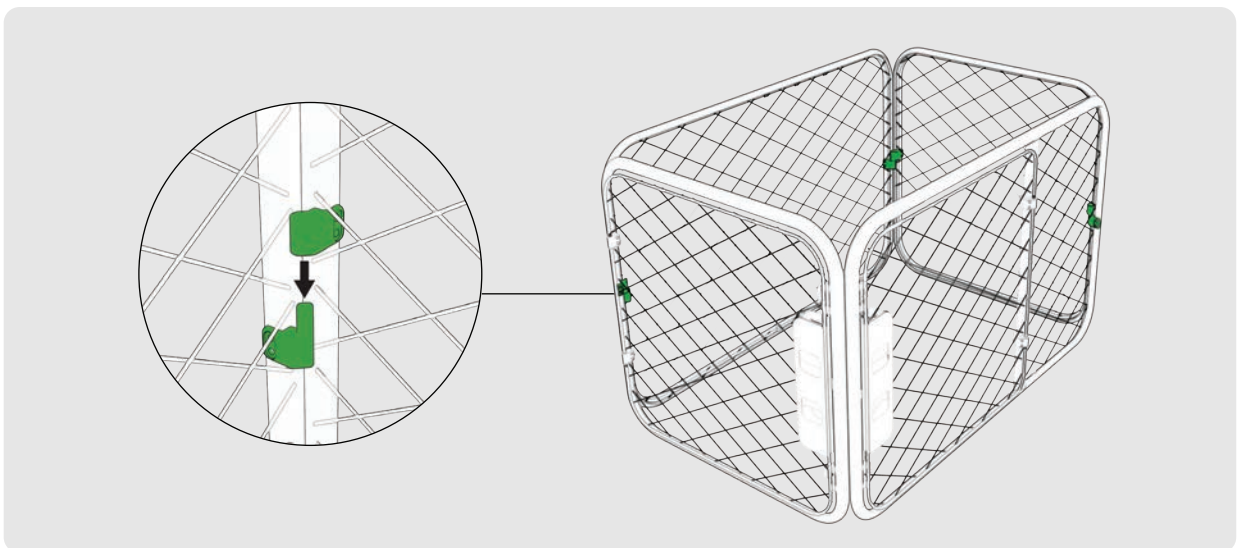

2.0 Assembly Instructions

- 5** Place the base frame, notched side down, on the top of the 4 side panels.

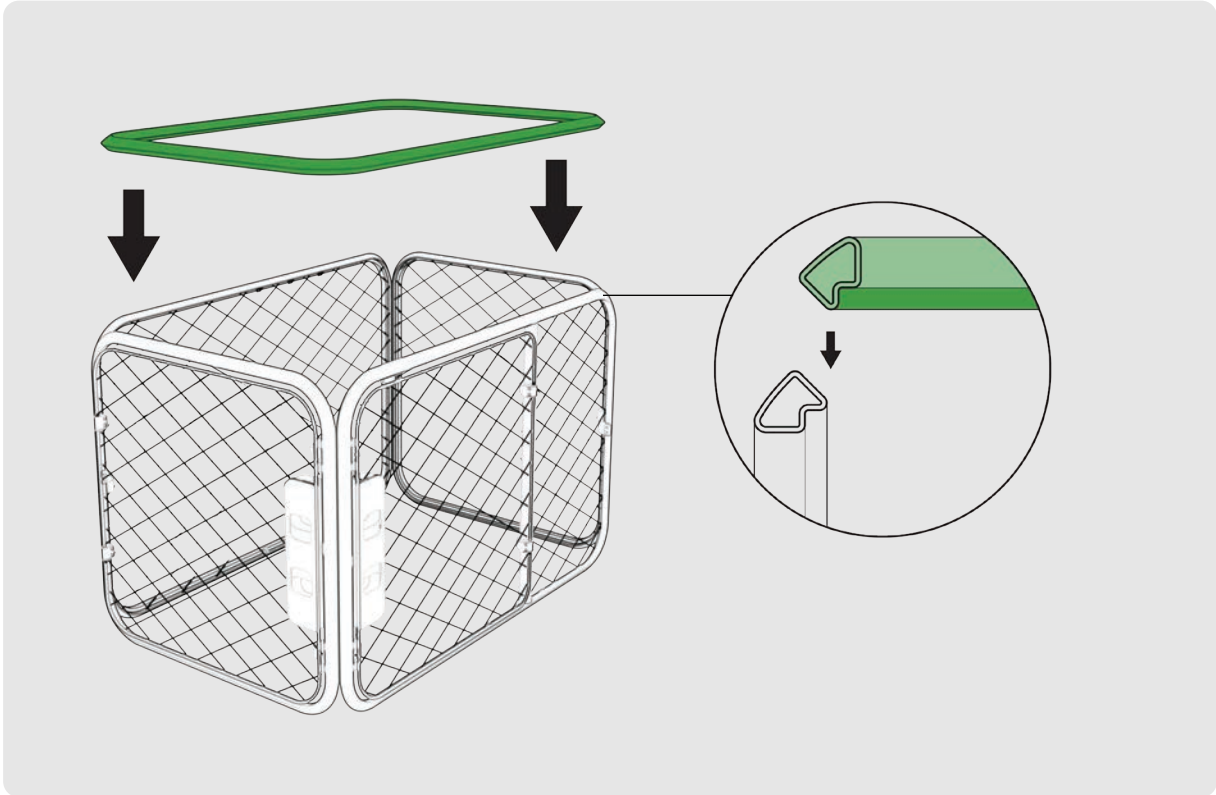

- 6** Install the bottom corners:

6a. Locate the 4 bottom corner connectors (bottom corners have a base plate and circular “foot”) and rotate the knob into the open position.

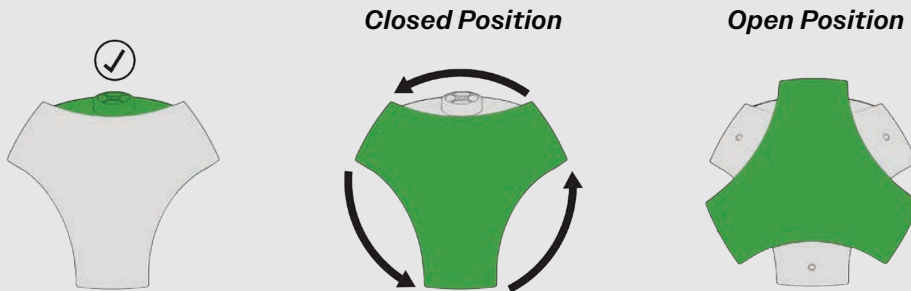

2.0 Assembly Instructions

6

6b. Hold the base frame and side panels together with one hand. With the foot facing up, place the bottom corner connector over the intersection of the frames.

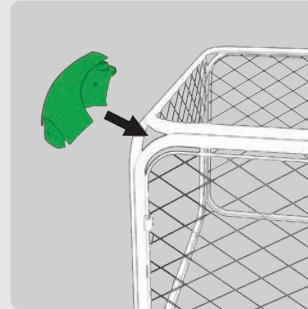

6c. Press the corner firmly against the frames, and rotate the knob clockwise until the shapes are aligned and the corner is locked together.

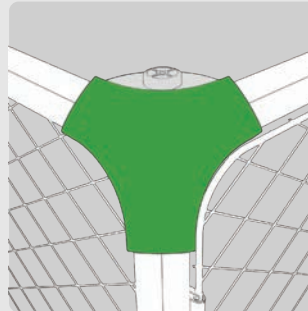
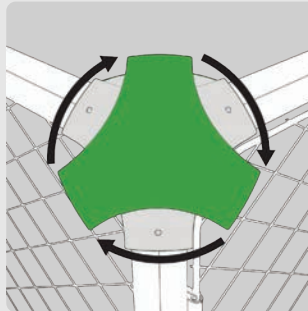

6d. Check the inside of the crate to ensure that the frames are completely captured by the rotating triangle on the corner connectors.

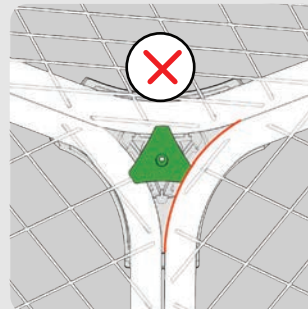
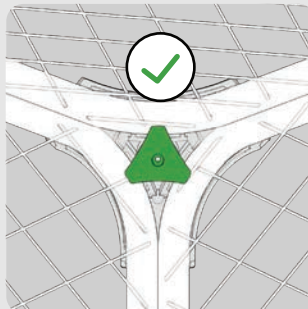

2.0 Assembly Instructions

6e. Starting with the opposite corner, repeat this process for the remaining 3 bottom corners, continuing to check for proper connection at each one

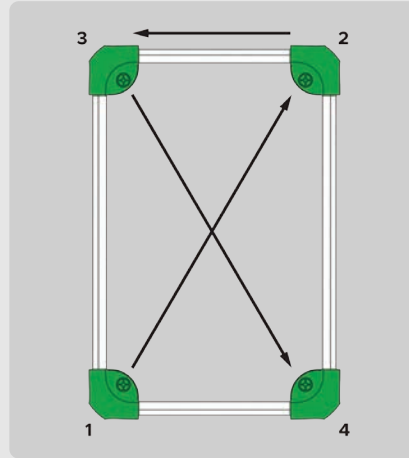

7 Flip the crate over so the feet on the bottom corners sit on the floor. For the Intermediate, Large and XL crate sizes we recommend 2 people flip the crate.

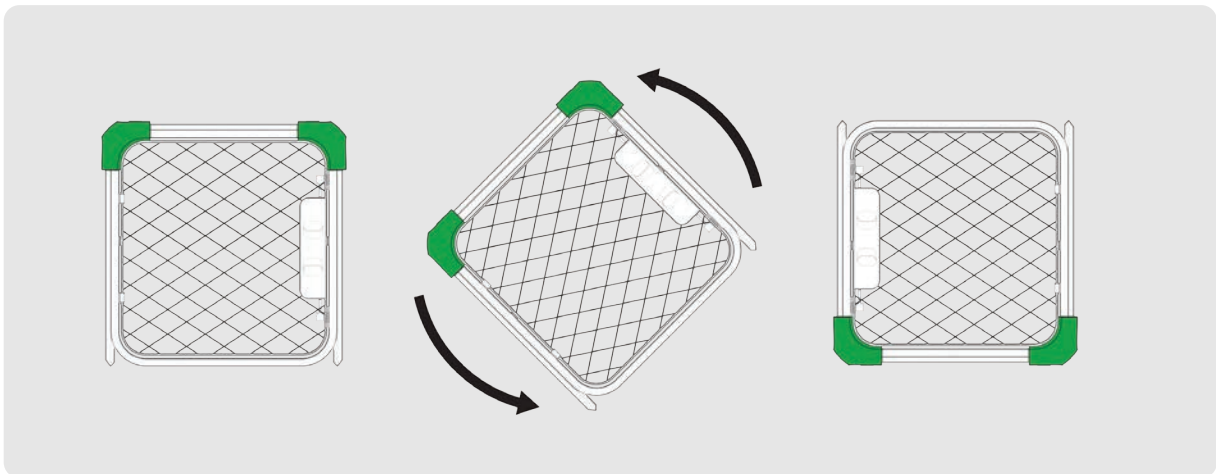

2.0 Assembly Instructions

- 8** Insert the tray into the bottom of the crate through the opening where the ceiling will be installed. The tray will nest within the notch in the bottom frame.



2.0 Assembly Instructions

- 9** If you need to install the puppy divider, please continue with step 9a. If your dog is fully grown, continue to step 10.

9a. Insert the puppy divider feet into the pair of base holes that are most appropriate to the size of your dog.

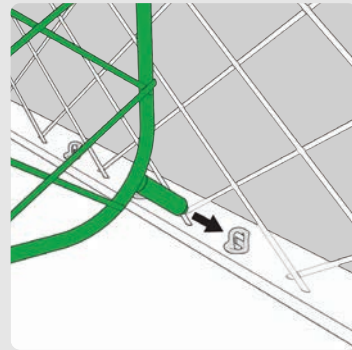

9b. At the top of the divider, align the locking pins with the corresponding holes in the frame, and slide them towards the outside of the crate until they snap into the locked position.

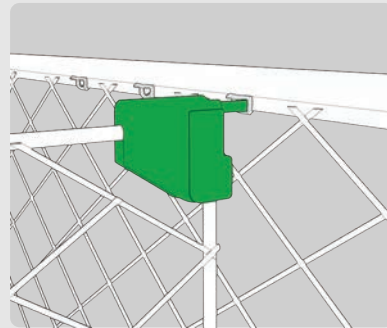
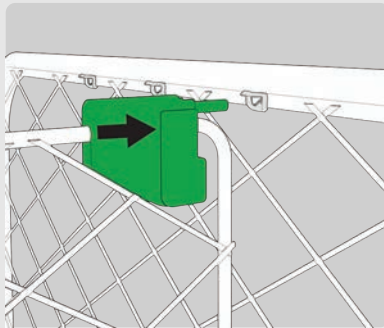

2.0 Assembly Instructions

- 10** Place the ceiling panel, notched side down, on the top of the 4 side panels.

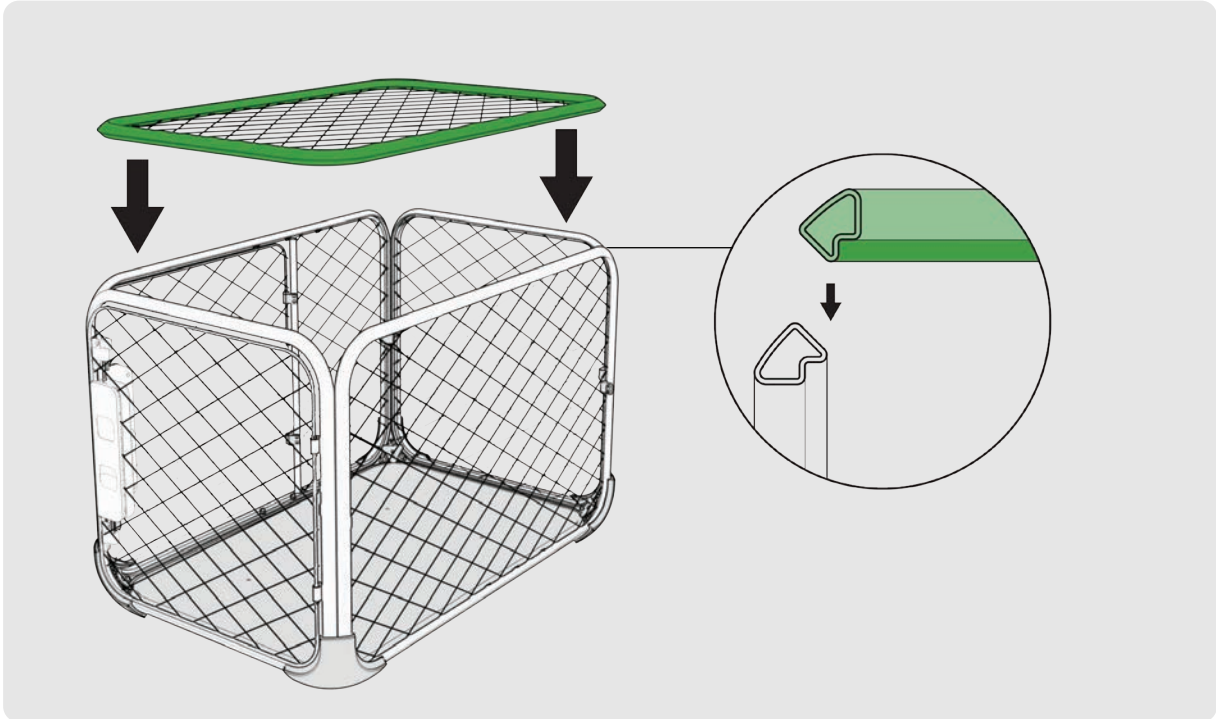

- 11** Install the top corners:

11a. Locate the 4 top corner connectors and rotate the knob into the open position.

Closed Position



Open Position



2.0 Assembly Instructions

11b. Hold the base frame and side panels together with one hand. Place the top corner connector over the intersection of the frames.

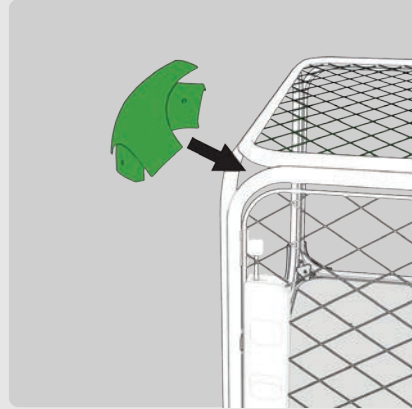

11c. Press the corner firmly against the frames, and rotate the knob clockwise until the shapes are aligned and the corner is locked together.

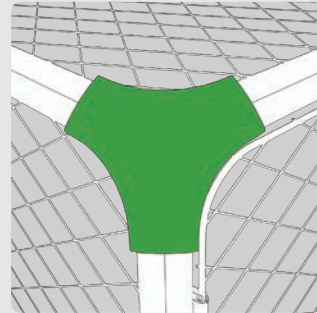
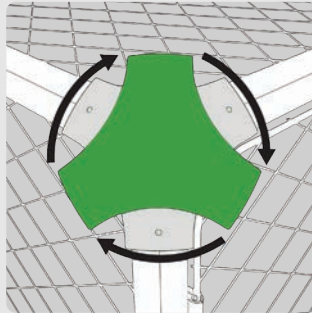

11d. Check the inside of the crate to ensure that the frames are completely captured by the rotating triangle on the corner connectors.

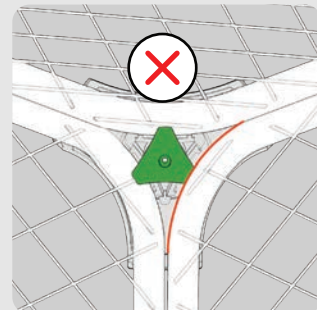
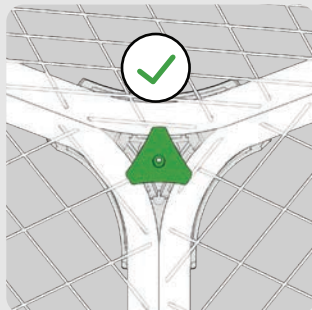

2.0 Assembly Instructions

11e. Starting with the opposite corner, repeat this process for the remaining 3 top corners, continuing to check for proper connection at each one

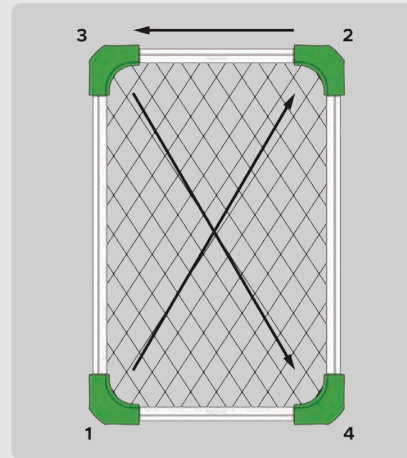

3.0 Crate Doors

To Open:

Squeeze both sides of the door handle together and swing the door out.

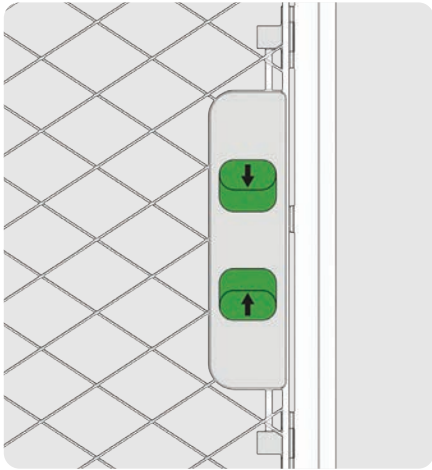

To Close:

Squeeze both sides of the door handle together, press the door in until it contacts the frame, and release the handles. Check that the locking pins are engaged with the latch, and pull on the mesh firmly to ensure the door is secure.

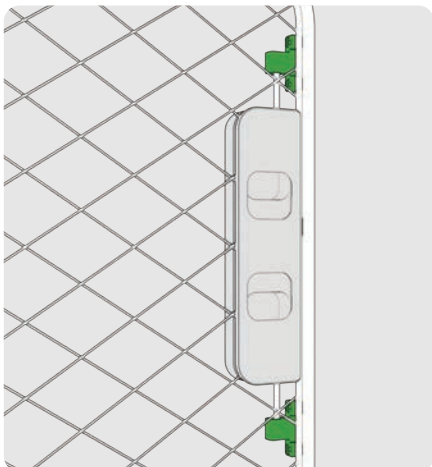

4.0 Puppy Divider

If you are using the puppy divider, it will need to be re-positioned or removed as your dog grows into the crate. To do this:

- 1 Disengage the top corner connectors.**
 - a. Place your left thumb on the top of the left arm of the corner knob.
 - b. Place your right thumb below the right arm of the corner knob.
 - c. Simultaneously press down with your left thumb, and up with your right thumb until the knob rotates out of the locked position.
 - d. Pull the corner away from the frames.
 - e. Repeat this process for the remaining 3 top corners and set them aside.
- 2 Lift the ceiling panel off the crate and set it aside.**
- 3 Disengage the locking pins at the top of the puppy divider from the holes in the frame.**
- 4 Lift the puppy divider feet out of the holes in the base.**
- 5 If the divider needs to be re-positioned please return to step 9 of the assembly instructions and continue. If you no longer need the puppy divider, return to step 10 of the assembly instructions and continue.**

5.0 Removing The Tray

For proper function the tray must be used any time a dog is inside, however the tray can be removed for cleaning.

⚠ Please note: If there is a puppy divider installed, **it needs to be removed.** Please consult the puppy divider section of this manual.

- 1** Open the front door.
- 2** Remove any loose objects or messes, and wipe out any liquids with an absorbent cloth or paper towel.
- 3** Gently lift the front of the crate until it is slightly off the floor.
- 4** Reach underneath the crate and push the front of the tray up from the bottom until it can be grabbed by the opposite hand.
- 5** Remove the tray through the front door. You will need to angle the tray slightly to maneuver it through the door.

6.0 Disassembly Instructions

 [Video: How to Disassemble](#)

1 Disengage the top corner connectors.

- a. Place your left thumb on the top of the left arm of the corner knob.
- b. Place your right thumb below the right arm of the corner knob.
- c. Simultaneously press down with your left thumb, and up with your right thumb until the knob rotates out of the locked position.
- d. Pull the corner away from the frames.
- e. Repeat this process for the remaining 3 top corners and set them aside.

2 Lift the ceiling panel off the crate and set it aside.

3 Remove the puppy divider if it is installed. Please see the puppy divider section of this manual for instructions.

4 Remove the tray.

- a. Open the front door.
- b. Gently lift the front of the crate until it is slightly off the floor.
- c. Reach underneath the crate and push the tray up from the bottom until it can be grabbed by the opposite hand.
- d. The tray can be removed through either the front door or the open top.
- e. Close the front door and set the tray aside.

5 Flip the crate over so that it is upside-down. For the Intermediate, Large and XL crate sizes we recommend 2 people flip the crate.

6.0 Disassembly Instructions

- 6** Using the same process you followed to remove the top corners, disengage all 4 bottom corner connectors and set them aside.
- 7** Lift the base frame off the crate and set it aside.
- 8** One at a time, slide the post and hole features on the side panels apart until all sides are disconnected.

7.0 Troubleshooting

The corner connectors don't align properly with the frames:

- 1** Double check that all of the post and hole edge connectors are fully seated against one another.
- 2** Check the other corners you have attached to the crate. If one of those is misaligned, it is very likely to make other corners difficult to assemble. Seen from the inside, the rotating triangle should completely capture all 3 frames as shown:

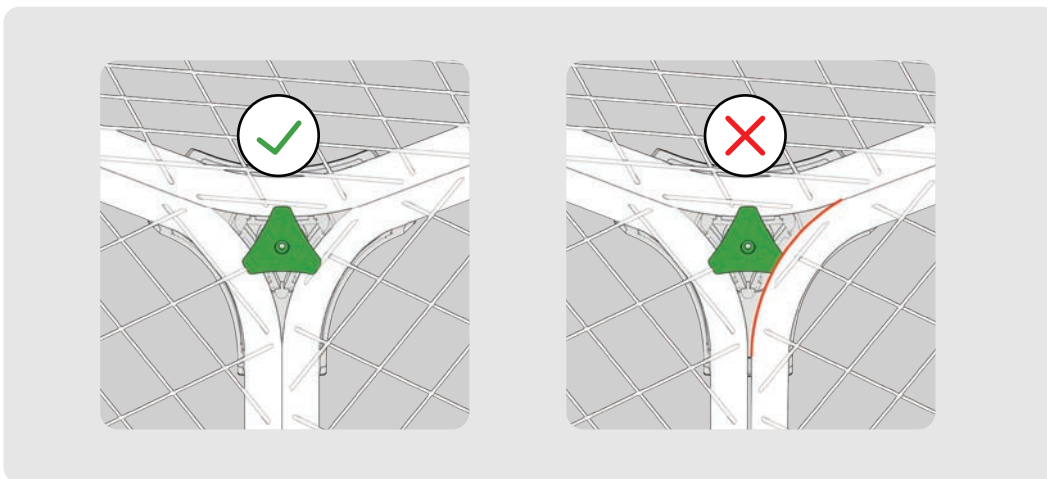

- 3** When attaching the corners, it is critical that the metal frames are tight against one another. If you see any gaps, we recommend trying to squeeze the frames together with one hand while you attach the corner with the other hand. It can also be helpful to push in on the corner as you are rotating the outer knob to help hold everything in proper alignment.
- 4** If these steps don't help, it is possible that a part of the crate is bent/warped and will require a replacement part.

7.0 Troubleshooting

The corner connectors are difficult to turn:

- Remove the corner from the crate.
- Use a phillips head screwdriver to loosen the knob screw ¼ turn at a time until the corner attaches to the crate easily.

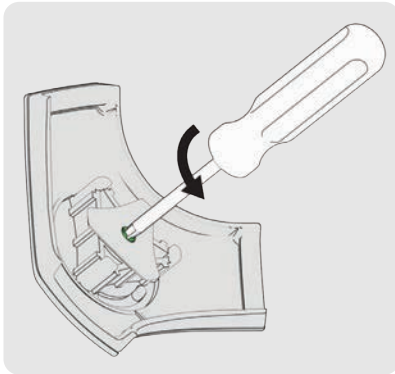

A part of the crate is damaged or broken:

- Spare parts under warranty are available at:
<https://www.diggs.pet/registration-warranty/>
- Spare parts outside of warranty are available at:
<https://www.diggs.pet/collections/evolv-spare-parts/>
- Panels and corner connectors are interchangeable. To replace the broken part, simply disassemble the crate, replace the old part with the new one, and re-assemble.
- To replace post and hole panel connectors, simply unscrew the broken part and replace it with the new one.

8.0 Warnings

Warnings

Failure to follow these warnings and instructions could result in serious injury or death. Read all instructions before assembly or use of your Evolv Crate (the “Crate”).

- Do not use the Crate if it is damaged or broken.
- Always ensure that the front and side doors are securely locked.
- Children should never enter the Crate. Children must not operate the Crate without adult supervision.
- Always remove the dog’s collar, harness, tags, and leash before allowing the dog in the Crate.
- For their safety, dogs should undergo thorough crate training. During this training period, closely monitor your dog when they are in the Crate.

9.0 Registration & Resources

If through some unforeseen circumstance Diggs Inc. needs to issue a product recall, we ask that you please register your Evolv Crate. You may do this by registering online at <https://www.diggs.pet/registration>.

Head to our [diggs.pet/resources](https://www.diggs.pet/resources) for helpful how-to videos and e-books including our Ultimate Guide to Crate Training.

10 Warranty

Diggs Warranty

Diggs Inc. warrants to the original purchaser of every Evolv Crate (“Crate”) that the unit will be free of defects in materials and workmanship under normal use for 1 year from the date of original purchase, with the exceptions stated below.

Diggs Inc. will repair any Crate that proves to be defective in materials or workmanship. In the event repair is not possible, or if Diggs Inc. otherwise thinks necessary, Diggs Inc. either will replace your Crate with a new Crate of similar composition and price or refund the full purchase price of your Crate.

This warranty expressly excludes any defects or damages caused by accessories, replacement parts, modification, or repair service other than those that have been authorized by Diggs Inc.. This warranty does not cover any damage caused by accident, misuse, shipment, or other than ordinary use. This warranty does not cover damage caused by dogs who are not Crate trained or who are improperly Crate trained, including damage caused by biting or chewing on the Crate. This warranty does not cover fading or discoloration by exposure to sunlight or chemicals. For information on how to prevent fading or discoloration, consult the instruction manual included with the Crate.

This warranty excludes all incidental or consequential damages. Some jurisdictions do not allow the exclusion or limitation of these damages, so these exclusions may not apply to you.

To request service or obtain additional warranty information, contact Diggs Inc. at info@diggs.pet. A service representative will instruct you on any necessary action required to correct problems covered by this warranty.

This warranty gives you specific legal rights, and you may also have other rights that vary from jurisdiction to jurisdiction.