

## Evolve Modern Dog Crate

### Additional Configuration Instructions

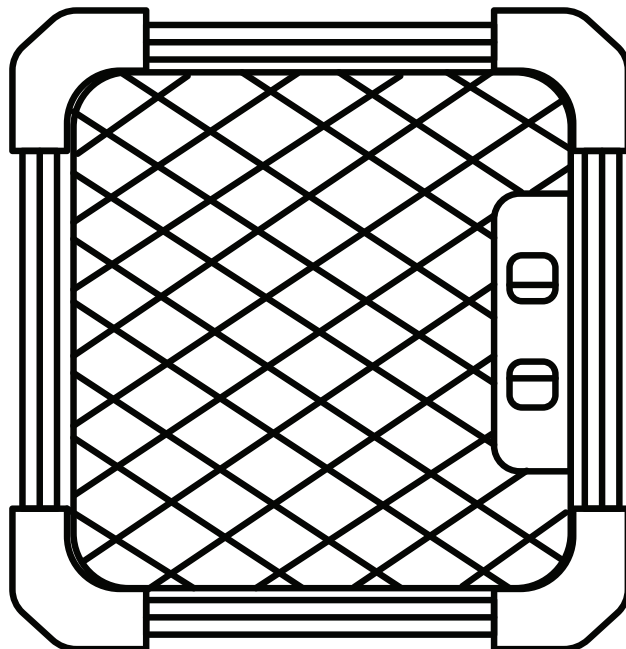

---

1.0 Installing Second Side Door

2.0 Installing Back Door

3.0 Converting to Playpen mode

4.0 Converting to Den mode

## 1.0 Installing Second Side Door

 [Video: Installing Second Side Door Instruction](#)

### Part/tools needed

- Assembled Evolv Crate
- Extra Side Door Panel
- Extra Edge Connectors
- Philips Head Screwdriver (not included)

### Instructions

- 1** Open the front door and remove the tray and anything else inside the crate (eg. Bolstr pad, Crate Bowl with Clip, Groov, etc.). If installed, also remove the puppy divider.
- 2** Close the front door and unlock and remove the four (4) corner pieces that hold the ceiling in place. Set these pieces aside.

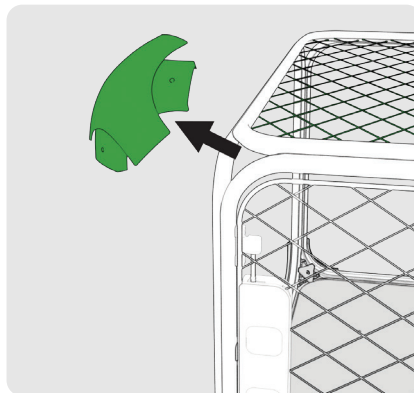
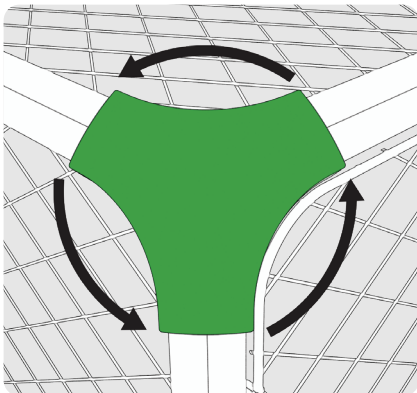

## 1.0 Installing Second Side Door

- 3** Remove the ceiling panel.

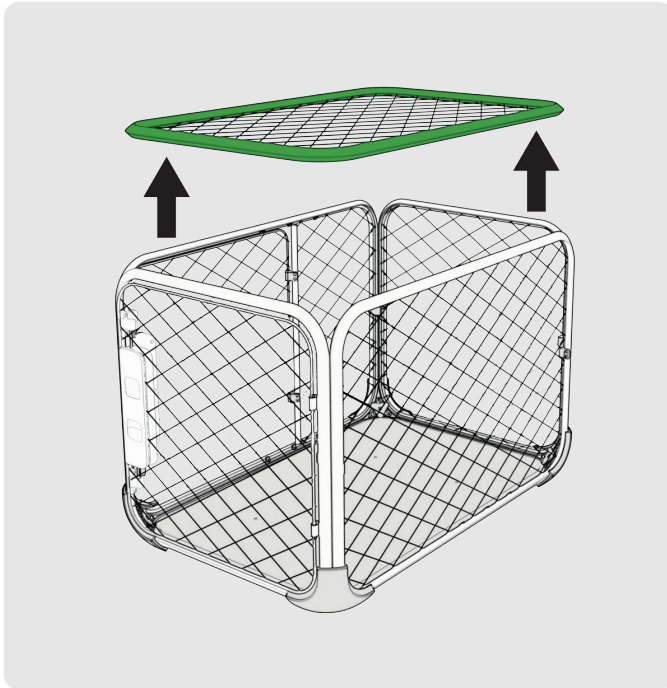

- 4** Flip your crate over so the open base panel is facing upward. For the Intermediate and Large crate sizes we recommend 2 people flip the crate.

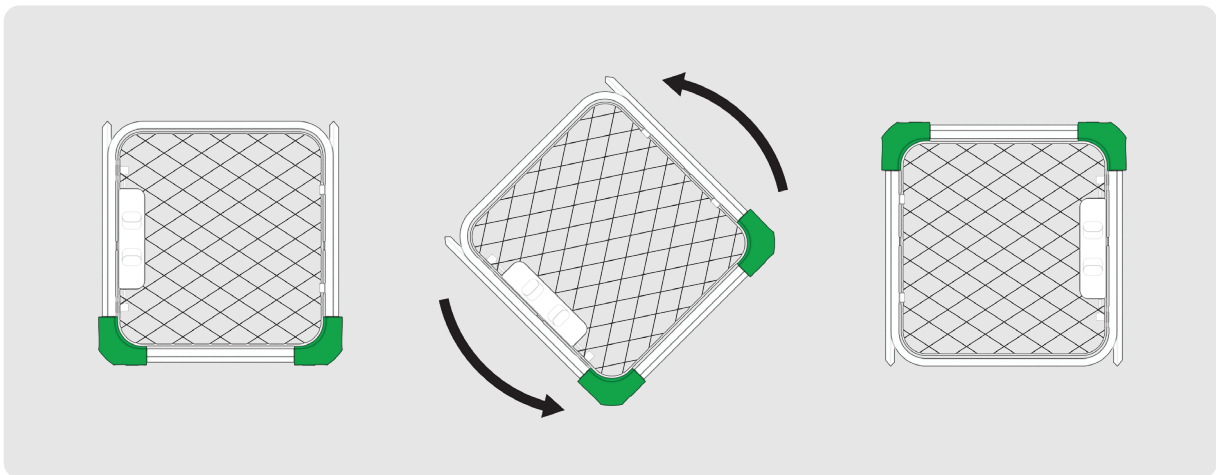

## 1.0 Installing Second Side Door

- 5** Unlock and remove the four (4) corner pieces that hold the open base in place.

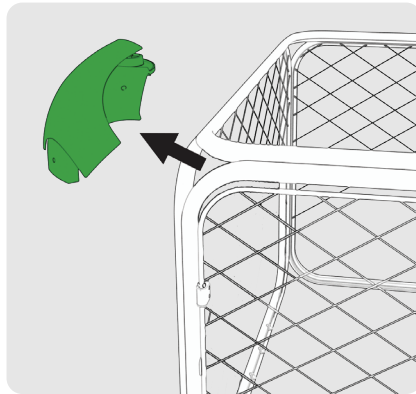
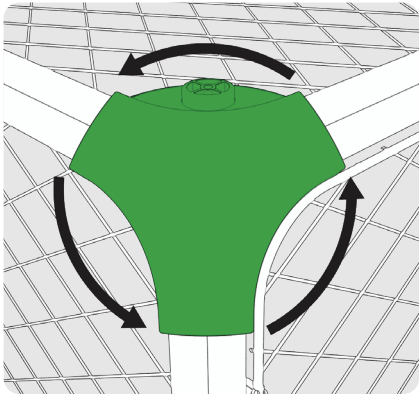

- 6** Remove the base panel and set aside.

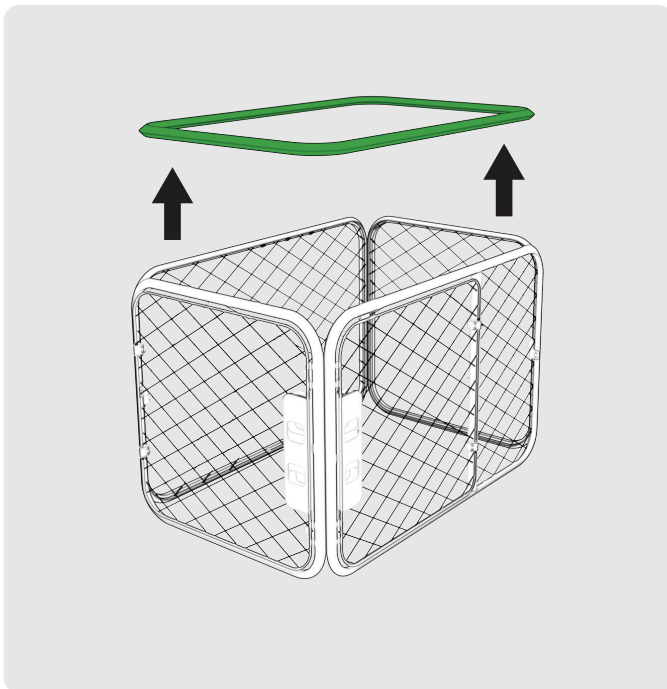

## 1.0 Installing Second Side Door

- 7** Remove the side panel without a door by sliding it out of the edge connectors that connect it to the front and back panels.

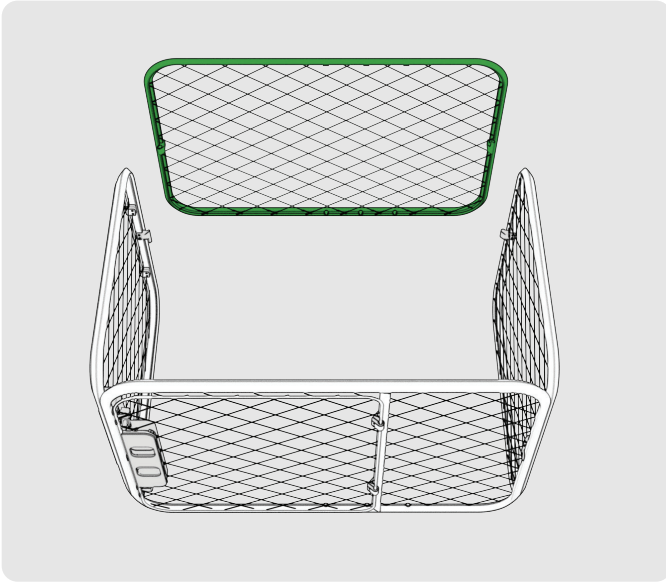

- 8** On the new side door, remove the edge connectors using a phillips head screwdriver. We recommend opening the door to allow better access.

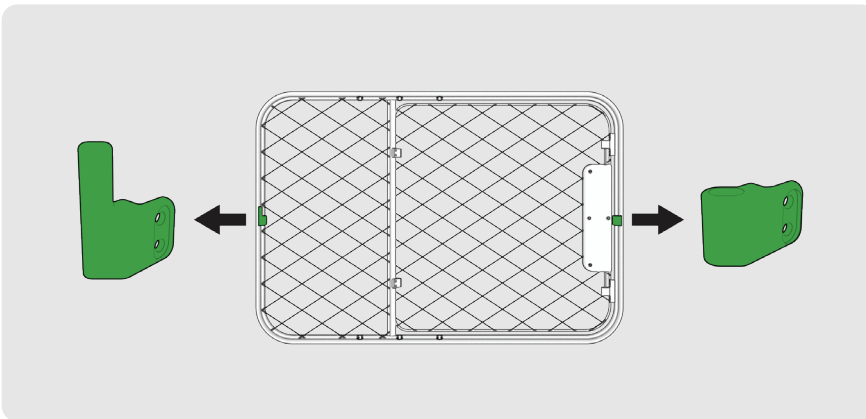

## 1.0 Installing Second Side Door

- 9** In the bag of extra edge connectors, find the connectors that match the ones shown below. Please note you will need 2 of each for Intermediate and Large sizes.

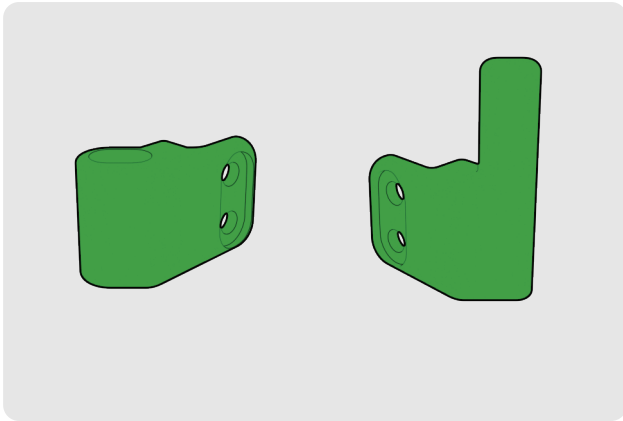

- 10** Screw these edge connectors into the new side door panel in the orientation shown below. Be sure to pay extra attention to both the orientation of the connectors and the orientation of the panel.

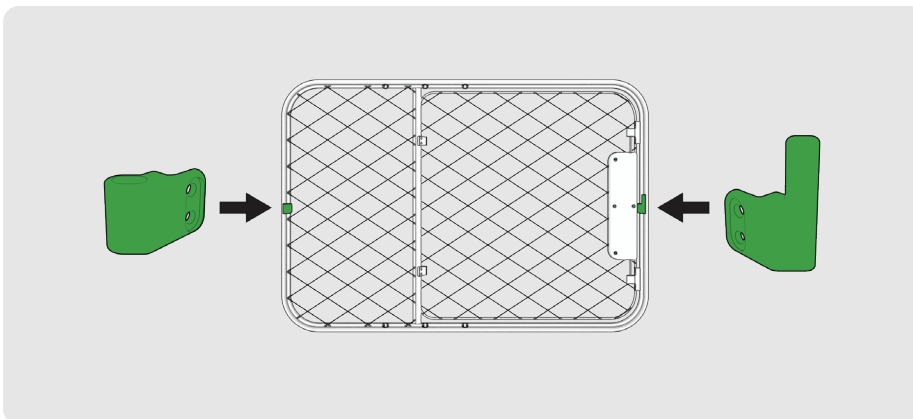

## 1.0 Installing Second Side Door

- 11** Install the new side door by sliding it into the edge connectors. There is only one orientation where the edge connectors can be properly aligned with the rest of the assembly.

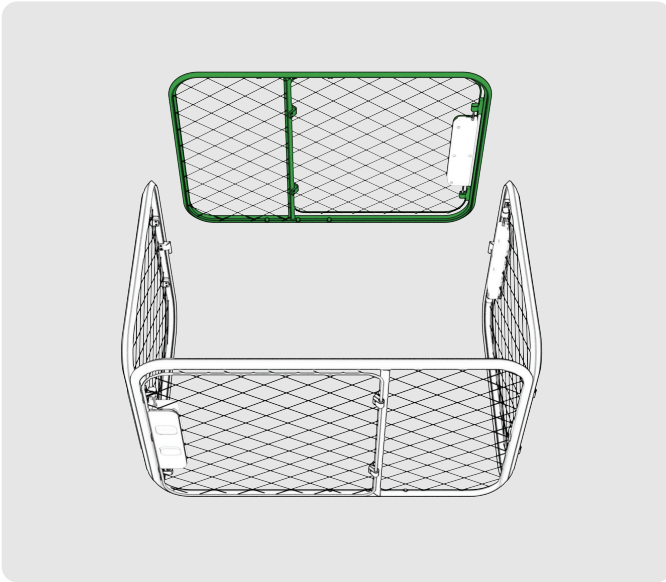

- 12** Re-install the open base panel and its four (4) base corner connectors. Make sure that the feet are oriented upwards.

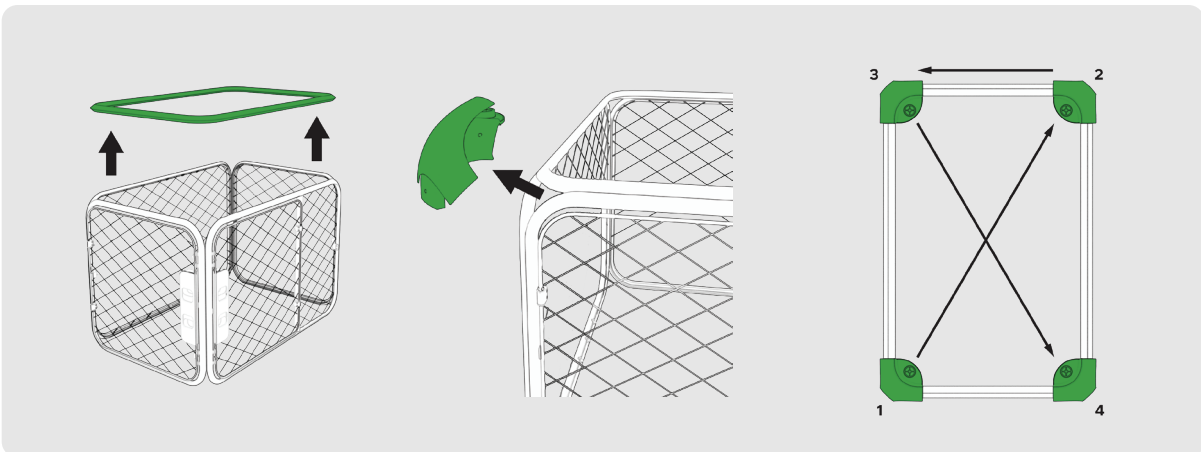

## 1.0 Installing Second Side Door

- 13** Flip your crate over. For Intermediate and Large size crates, we recommend getting help from a second person.

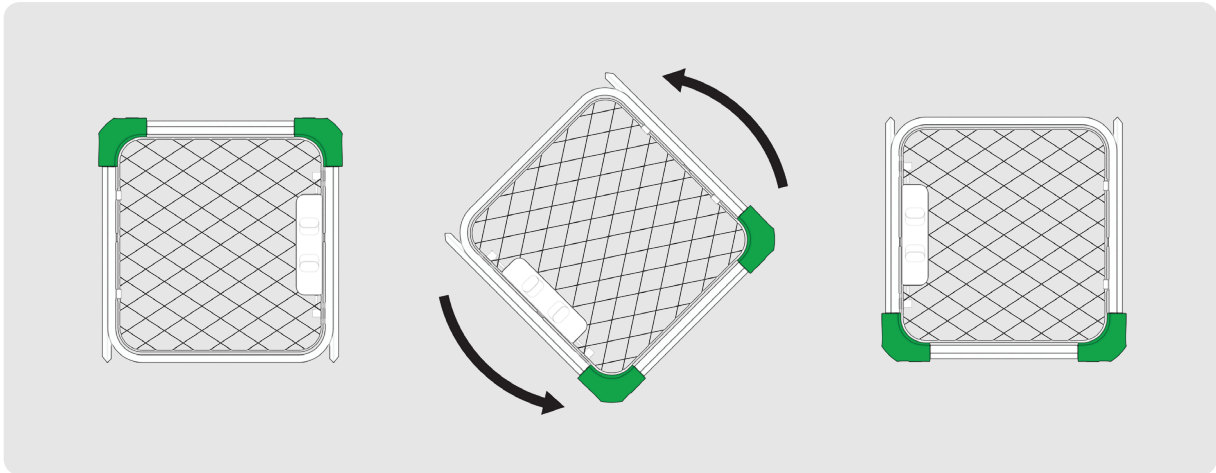

- 14** Place the tray back into your crate along with any other accessories you removed in step 1.

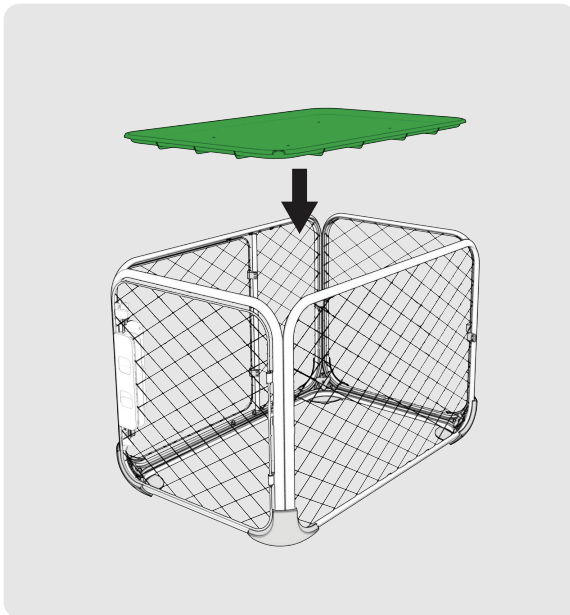



## 1.0 Installing Second Side Door

- 15** Re-install the ceiling panel and its four (4) corner connectors.

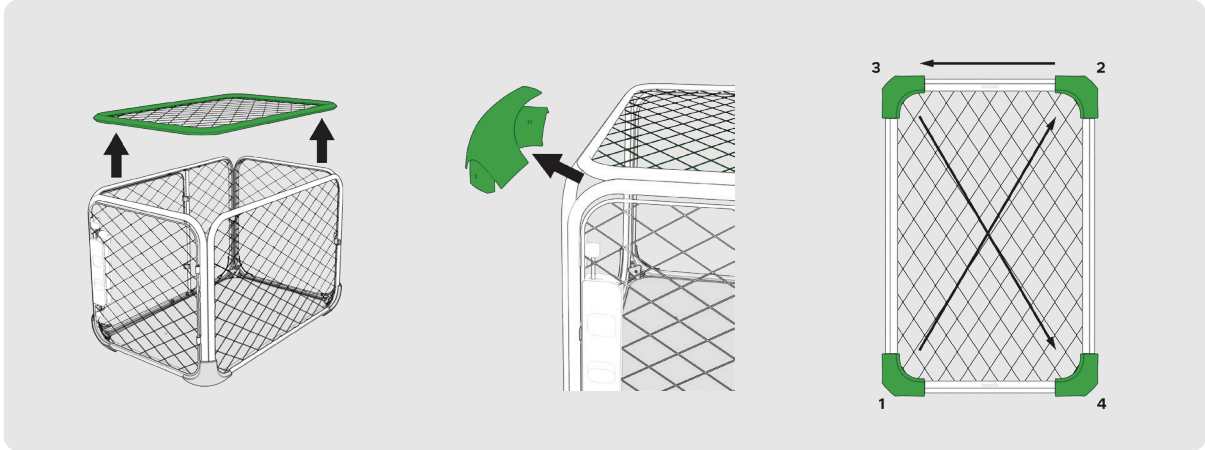

## 2.0 Installing Back Door

### Part/tools needed

- Assembled Evolv Crate
- Extra Front/Rear Door Panel
- Extra Edge Connectors
- Philips Head Screwdriver (not included)

### Instructions

- 1** Open the front door and remove the tray and anything else inside the crate (eg. Bolstr pad, Crate Bowl with Clip, Groov, etc.). If installed, also remove the puppy divider.
- 2** Close the front door and unlock and remove the four (4) corner pieces that hold the ceiling in place. Set these pieces aside.

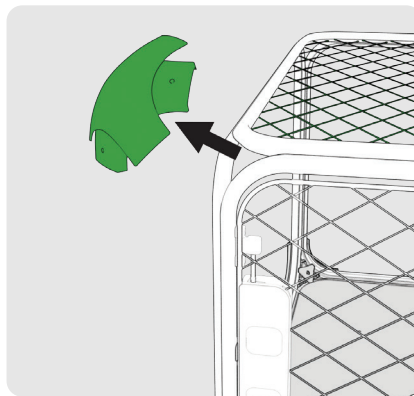
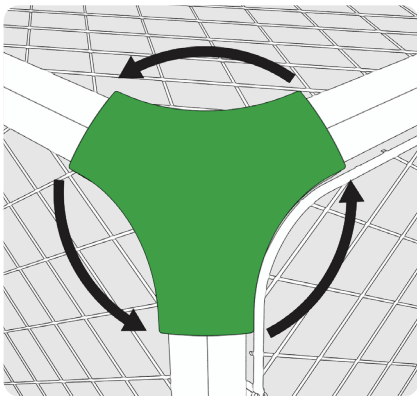

## 2.0 Installing Back Door

- 3** Remove the ceiling panel.

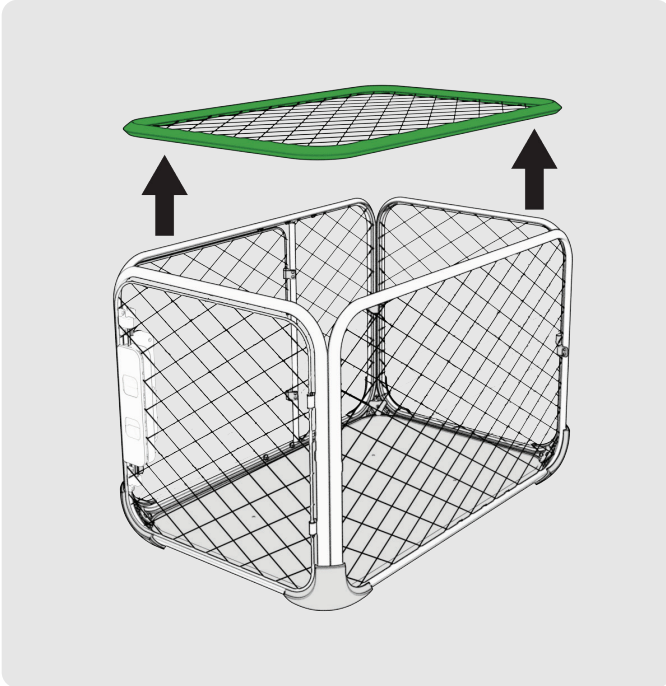

- 4** Flip your crate over so the open base panel is facing upward. For the Intermediate and Large crate sizes we recommend 2 people flip the crate.

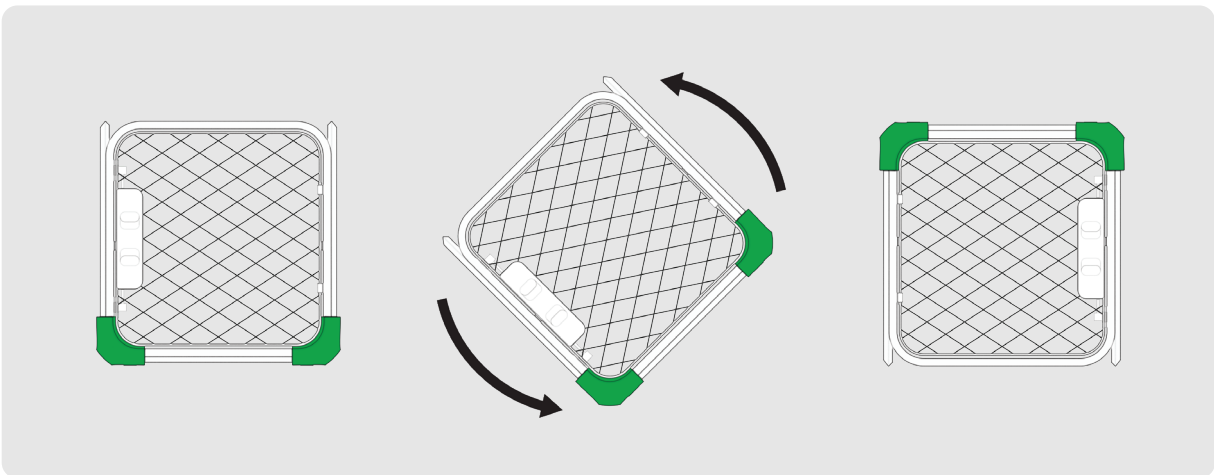

## 2.0 Installing Back Door

- 5** Unlock and remove the four (4) corner pieces that hold the open base in place.

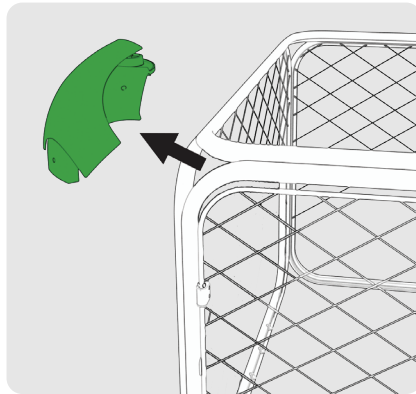
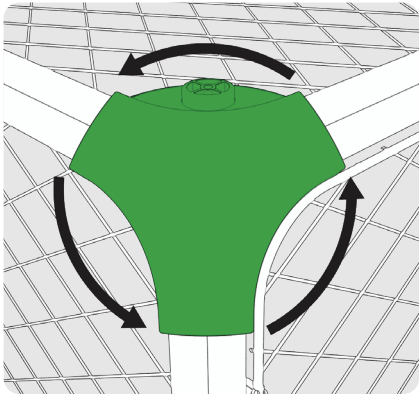

- 6** Remove the base panel and set aside.

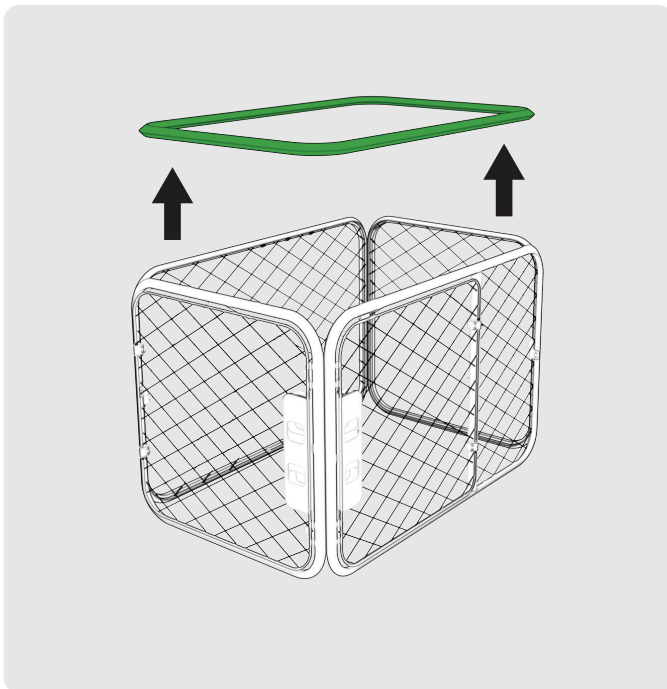

## 2.0 Installing Back Door

- 7** Now remove the back panel by sliding it out of the edge connectors that connect it to the two side panels.

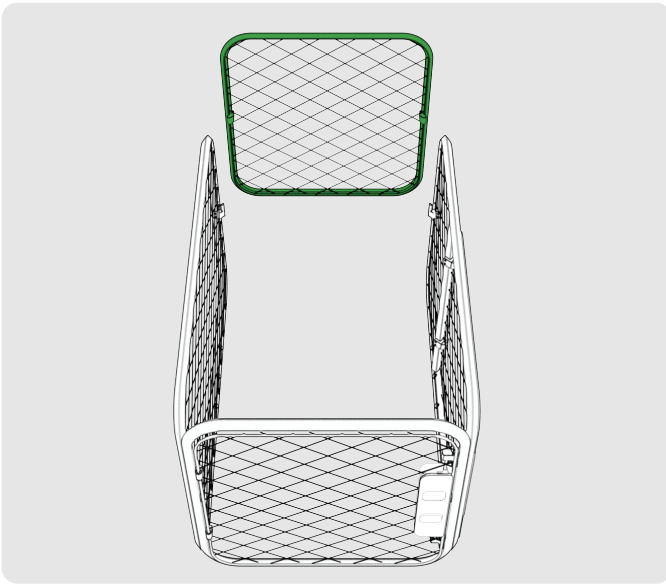

- 8** On the new door, remove the edge connectors using a phillips head screwdriver. We recommend opening the door to allow better access.

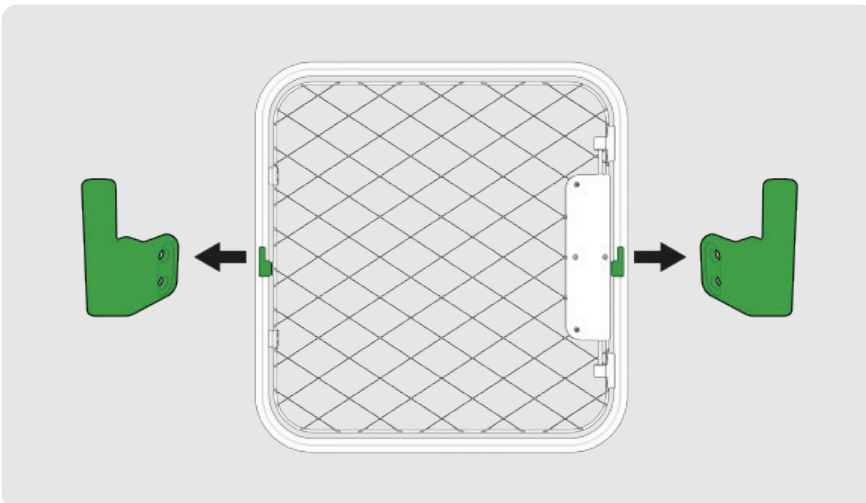

## 2.0 Installing Back Door

- 9** In the bag of extra edge connectors, find the connectors that match the ones shown below.

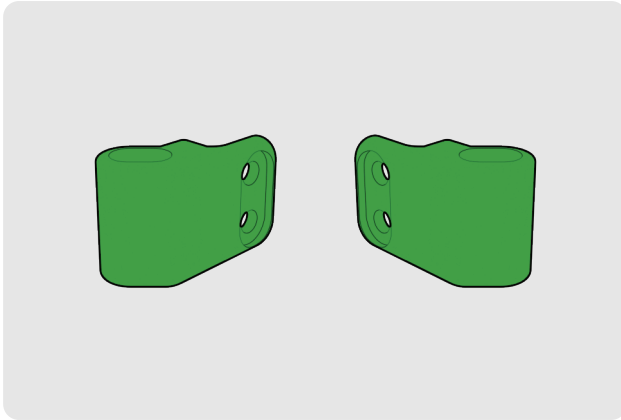

- 10** Screw these edge connectors into the new door panel in the orientation shown below. Be sure to pay extra attention to both the orientation of the connectors and the orientation of the panel.

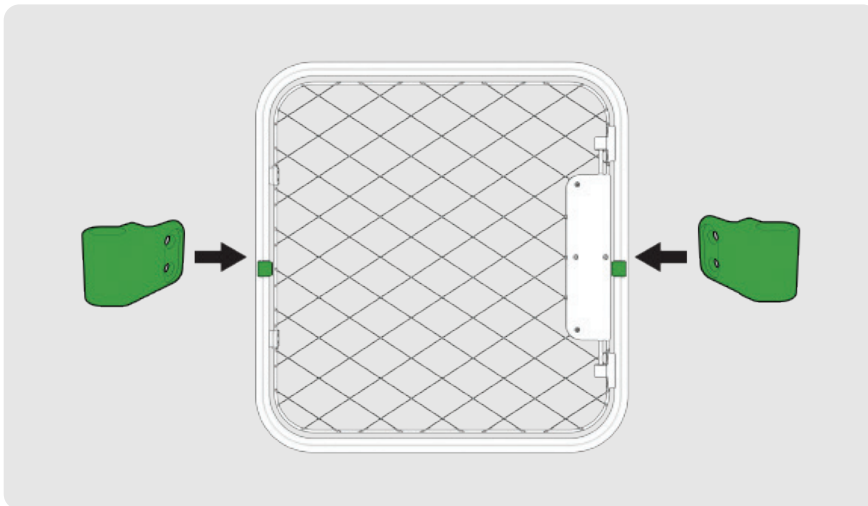

## 2.0 Installing Back Door

- 11** Install the new door panel by sliding it into the edge connectors. There is only one orientation where the edge connectors can be properly aligned with the rest of the assembly.

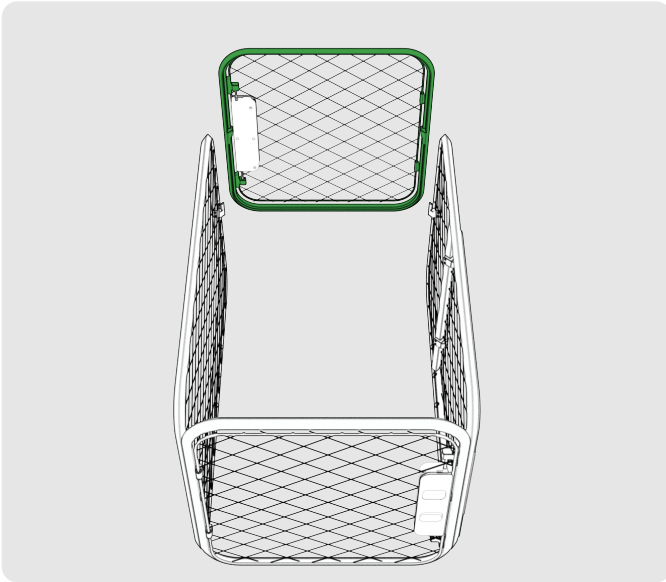

- 12** Re-install the open base panel and its four (4) base corner connectors. Make sure that the feet are oriented upwards.

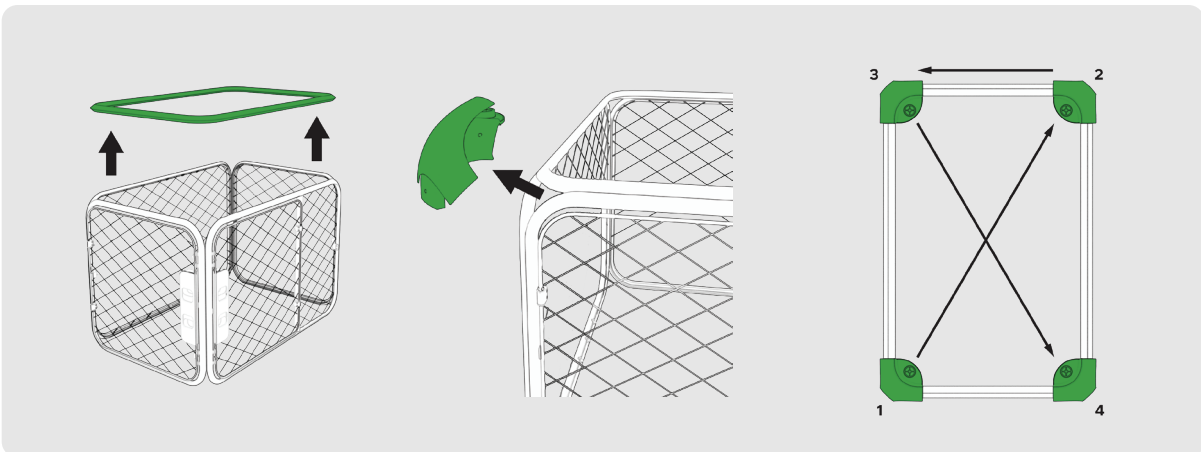

## 2.0 Installing Back Door

- 13** Flip your crate over. For Intermediate and Large size crates, we recommend getting help from a second person.

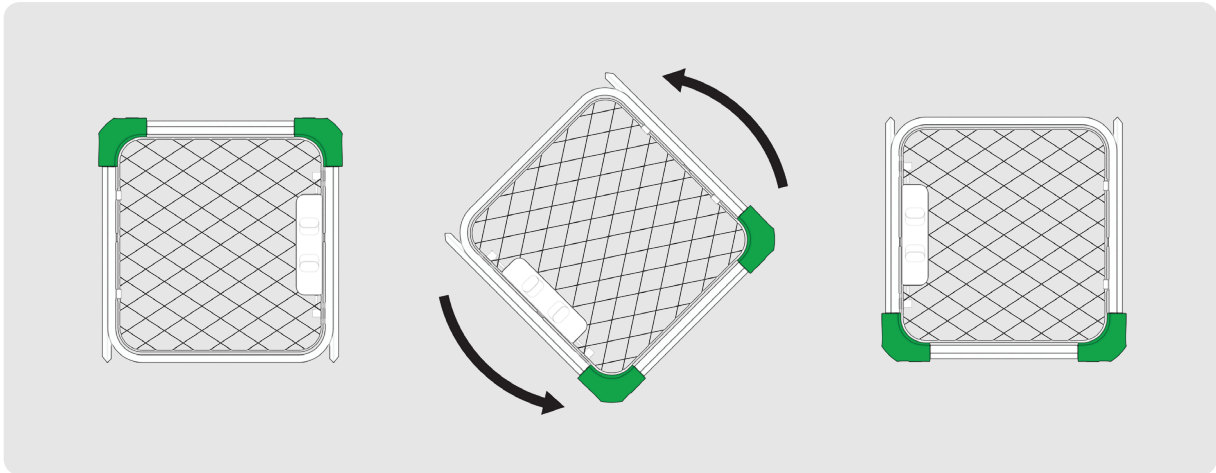

- 14** Place the tray back into your crate along with any other accessories you removed in step 1.

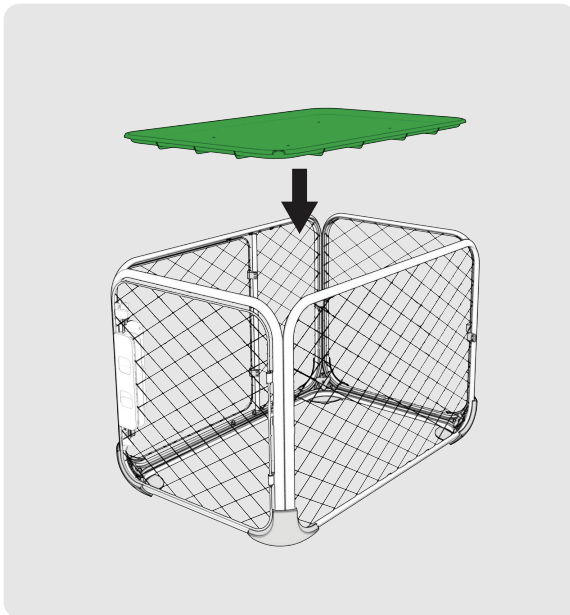



## 2.0 Installing Back Door

- 15** Re-install the ceiling panel and its four (4) corner connectors.

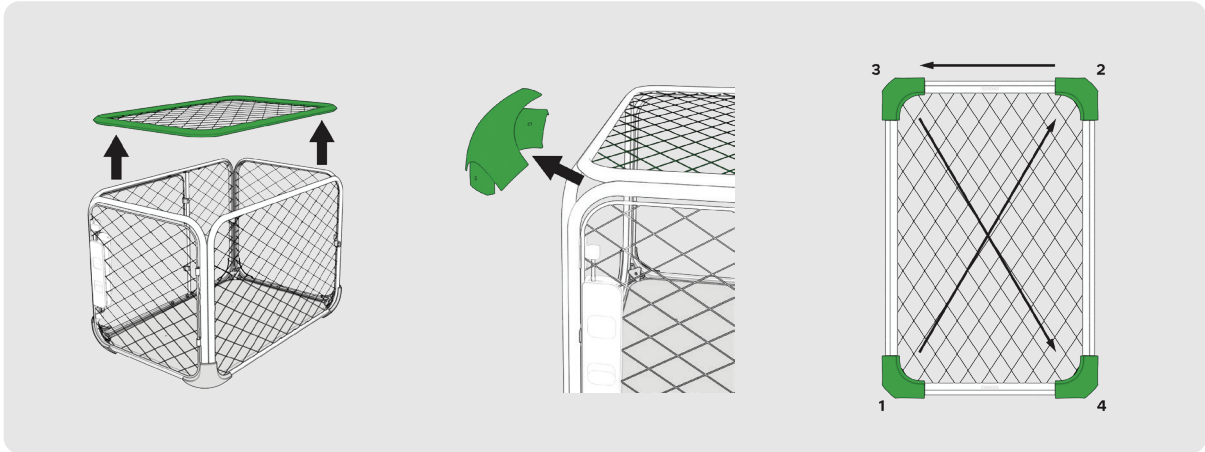

## 3.0 Converting to Playpen mode

 [Video: Converting to Playpen mode](#)

### Part/tools needed

- Assembled Evolv crate
- Playpen Ceiling Panel

### Instructions

- 1** Open the front door and remove the tray and anything else inside the crate (eg. Bolstr pad, Crate Bowl with Clip, Groov, etc.). If installed, also remove the puppy divider.
- 2** Close the front door and unlock and remove the four (4) corner pieces that hold the ceiling in place. Set these pieces aside.

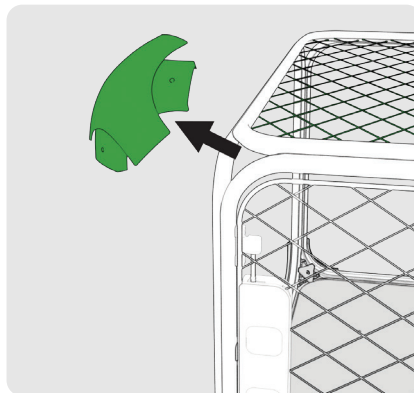
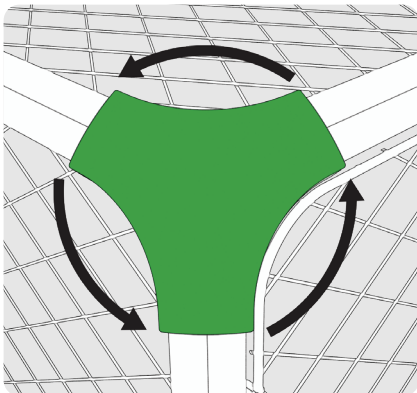

## 3.0 Converting to Playpen mode

**3** Remove the ceiling panel.

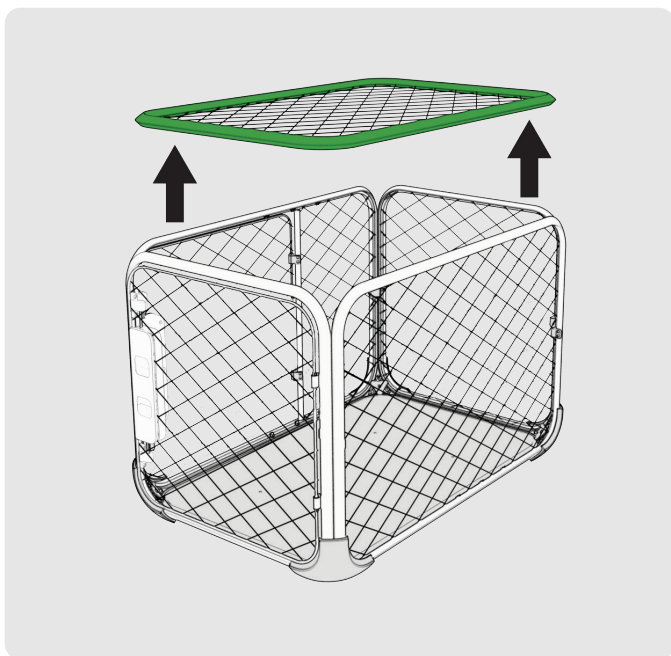

**4** Replace the mesh ceiling panel with the Playpen Ceiling Panel.

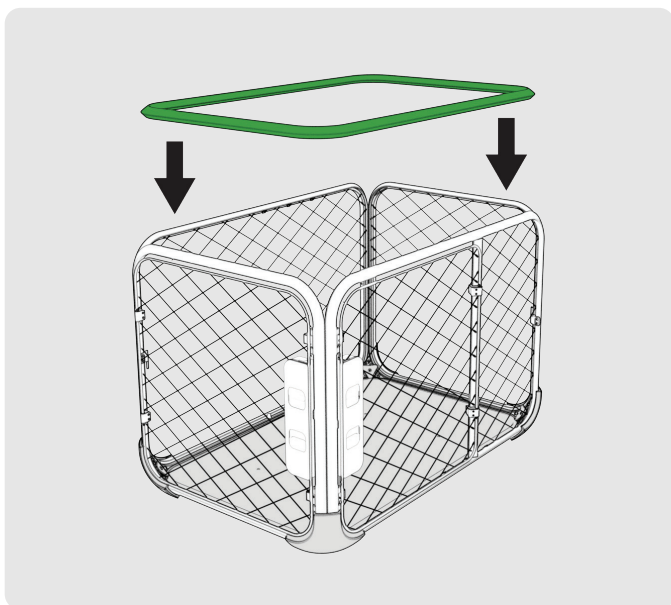

## 3.0 Converting to Playpen mode

- 5** Reinstall the four (4) corner connectors.

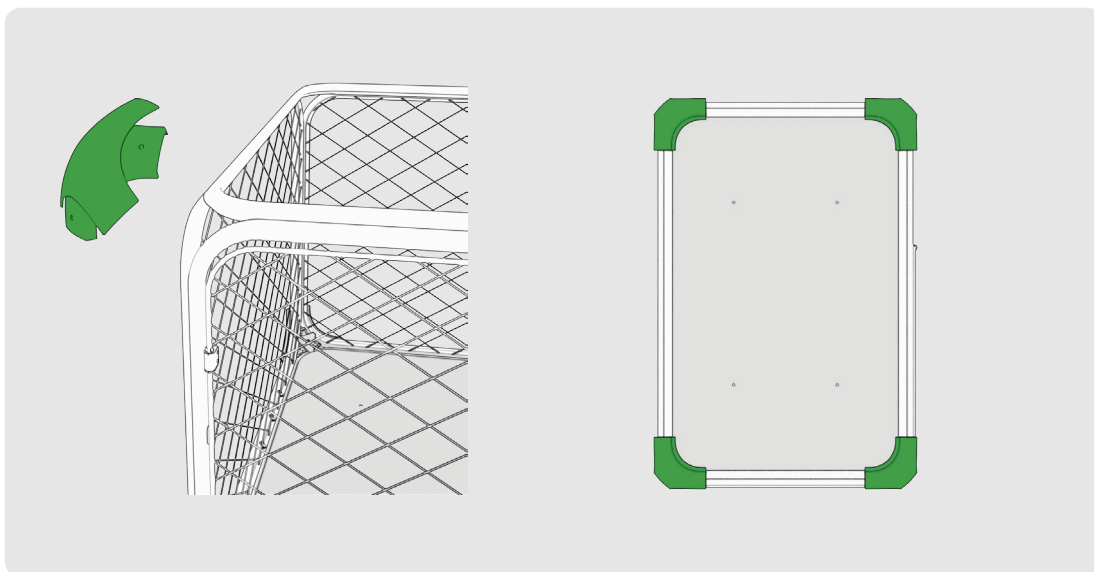

## 4.0 Converting to Den mode

### Part/tools needed

- Assembled Evolv Crate
- Philips Head Screwdriver (not included)

### Instructions

- 1** Open the side door.

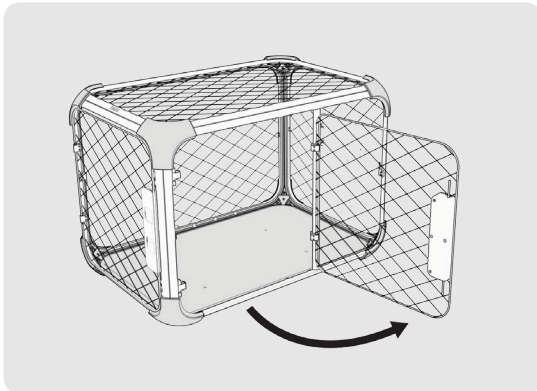

- 2** Using your screwdriver, remove the screws at each hinge. Depending on the size of your crate, there may be 2 (Small, Medium, Intermediate) or 3 (Large, XL) hinges.

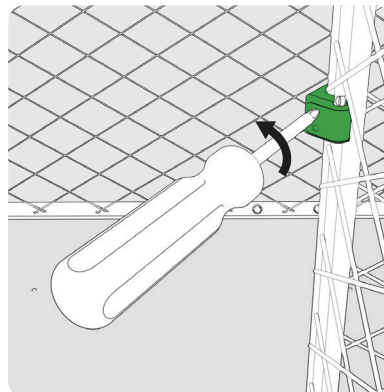
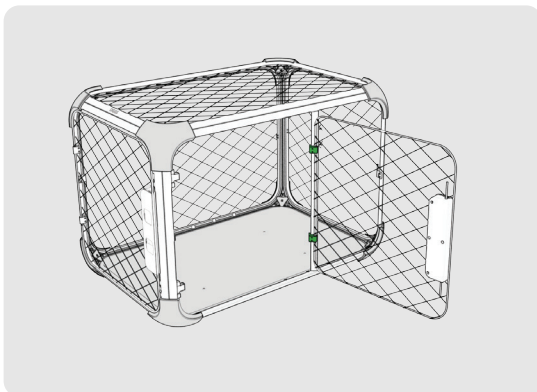

## 4.0 Converting to Den mode

- 3** Remove the door and hinges from the side panel frame, and keep it in a safe place in case you want to reinstall your side door.

