

0.81in [21mm]
(MAX INTONATION)

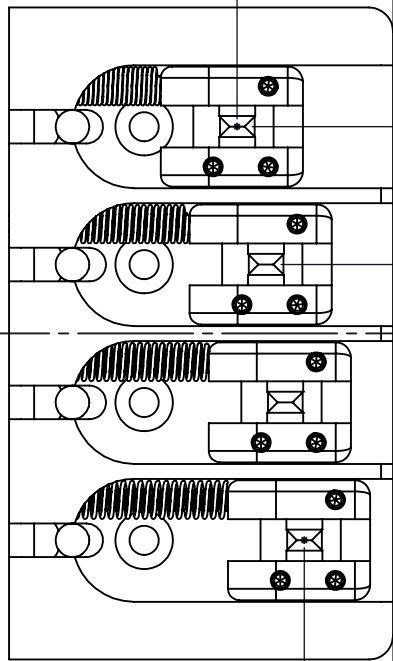

0.46in [12mm]
(MIN INTONATION)

0.63in [16mm]
(MAX STRING HEIGHT)

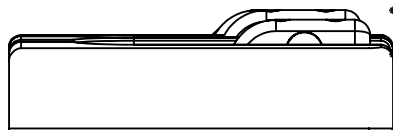

0.718in [18.2mm]
±.062in [1.5mm]
(STRING SPACING)

0.40in [10mm]
(MIN STRING HEIGHT)

QUICK RELEASE CHANNELS

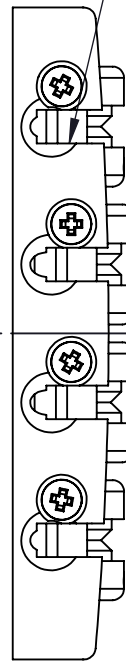

3.396in [86.3mm]

1.670in [42.4mm]

1.296in [32.9mm]

2.000in [50.8mm]

R0.125in [3.2mm]

1.077in [27.4mm]

1.077in [27.4mm]

0.359in [9.1mm]

0.359in [9.1mm]

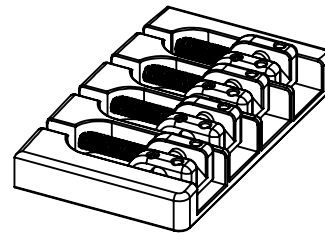

Scale

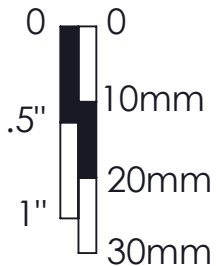

WEIGHT (WITH MOUNTING HARDWARE):
ALUM: 4.7oz [133g] **BRASS:** 9.7oz [275g]

THIS DRAWING IS THE SOLE PROPERTY OF HIPSHOT PRODUCTS, INC. ALL RIGHTS ARE RESERVED. DIMENSIONS AND PRODUCT FEATURES MAY CHANGE WITHOUT NOTICE.

UNLESS OTHERWISE SPECIFIED: DIMENSIONS ARE IN INCHES TOLERANCE: ± .005

REV DATE:
4/10/2021

5A400-718 4 STG A STYLE
BASS BRIDGE .718 SPACING
DIMENSIONS



8248 STATE ROUTE 96
Interlaken, NY 14847 U.S.A.
TEL:607-532-9404 FAX:607-532-9530
E-MAIL: info@HipshotProducts.com