



K9 FASTENERS®

PRODUCT CATALOG



FASTER

- Faster Start
- Faster Set
- Less Torque



STRONGER

- Stronger Ceramic Coating
- Stronger Protection
- Treated Lumber Approved



SAFER

- Safer Power Bit Pocket
- Safer Hold
- Anti Slip Performance

Order Online

Need current pricing? Working late? Want answers quickly?

With our easy-to-use web store, you can place orders, view pricing and much more!

Visit www.k9fasteners.com and click **SHOP NOW** to get started!

- View your current pricing and real-time product inventory
- Access order status and tracking information
- See your order history
- View outstanding and available balances

Not a current Web store user? Signing up is easy.

Fill out the form at: www.k9fasteners.com/account/register

If you are not a current K9 Fasteners customer, please contact us at 888.205.2355

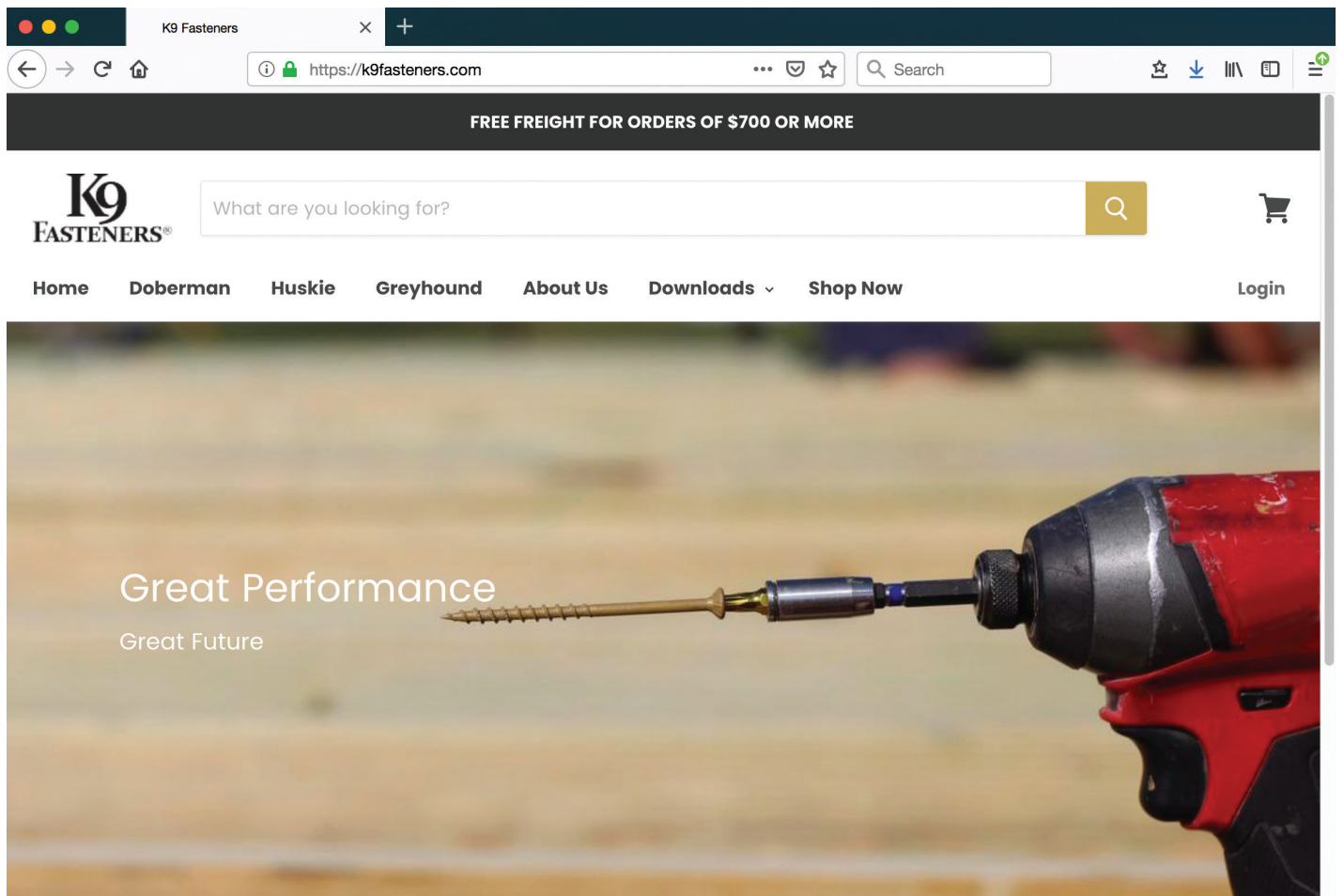
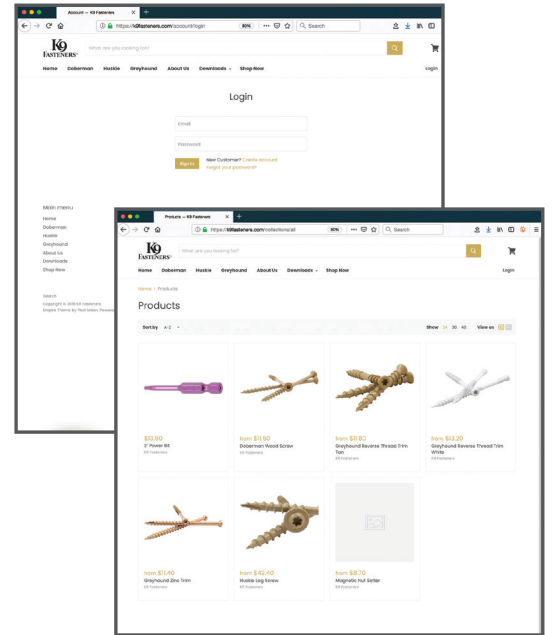



All of us here at K9 are thrilled to have this opportunity to continue the legacy of loyalty, value and performance that thousands of professionals have come to depend on. Notably, 2019 marked the 10 year anniversary of diligence and continuous improvement within the K9 line of products.

K9's fresh vision offers a renewed focus on your success. Based on market surveys, we are confident in our high market value. Whether you are new to K9 products or have chosen to exclusively provide k9 products to your customers, we all look forward to continued business growth. By incorporating new product branding, updated website design, and efficient online ordering, we are leading growth at K9.

We appreciate you being a part of the "PACK" as we look ahead to an exciting future together.

Sincerely,
K9 Sales Team



Doberman Premium Deck Screw page 2 - 5



Huskie Premium Construction Lag page 6 - 7



Greyhound Premium Trim Screw page 8 - 9

Performance Test page 10 - 11

Power Bits & Nut Setters page 12

Order Form & Info page 13 - 14



Doberman

Premium Deck Screw

Hardest working and loyal dog in the fight.

- Quick-bite tip
- 3X ceramic protection
- Anti slip bit pocket
- T25 Power Bit included in every box

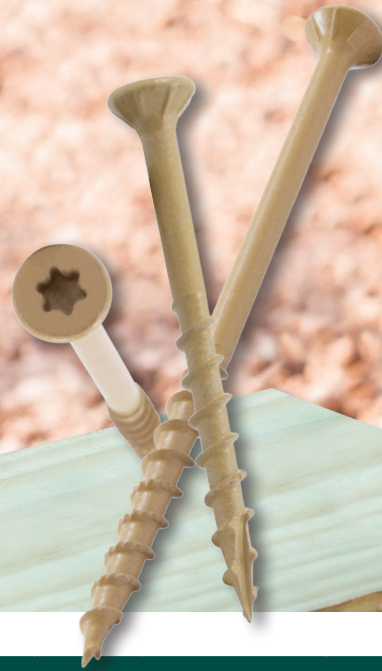

TAN CERAMIC

| K9 Item # | Vendor # | Screw Size | Color | Pack Size | Case Pack | Bit | QTY/Pack | MSRP* | MSRP*/Ea. |
|------------------|----------|-------------|--------------------|-----------|-----------|-----|----------|----------|-----------|
| D8132-158 | MP812158 | #9 x 1-5/8 | Tan Triple Ceramic | 1LB | 20 | T25 | 155 | \$ 11.50 | \$ 0.07 |
| D8132-200 | MP812200 | #9 x 2 | Tan Triple Ceramic | 1LB | 20 | T25 | 125 | \$ 11.50 | \$ 0.09 |
| D8132-212 | MP812212 | #9 x 2-1/2 | Tan Triple Ceramic | 1LB | 20 | T25 | 100 | \$ 11.50 | \$ 0.12 |
| D8132-300 | MP812300 | #9 x 3 | Tan Triple Ceramic | 1LB | 20 | T25 | 85 | \$ 11.50 | \$ 0.14 |
| D8132-312 | MP812312 | #10 x 3-1/2 | Tan Triple Ceramic | 1LB | 20 | T25 | 60 | \$ 12.00 | \$ 0.20 |
| D8133-114 | MP813114 | #9 x 1-1/4 | Tan Triple Ceramic | 5LB | 4 | T25 | 1250 | \$ 41.30 | \$ 0.03 |
| D8133-158 | MP813158 | #9 x 1-5/8 | Tan Triple Ceramic | 5LB | 4 | T25 | 923 | \$ 41.00 | \$ 0.04 |
| D8133-200 | MP813200 | #9 x 2 | Tan Triple Ceramic | 5LB | 4 | T25 | 624 | \$ 40.40 | \$ 0.06 |

*MSRP - Manufacturer's Suggested Retail Price is used to benchmark K9 Fasteners' value against competitive products.



TAN CERAMIC

| K9 Item # | Vendor # | Screw Size | Color | Pack Size | Case Pack | Bit | QTY/Pack | MSRP* | MSRP*/Ea. |
|-------------------|-----------|-------------|--------------------|-----------|-----------|-----|----------|-----------|-----------|
| D8133-212 | MP813212 | #9 x 2-1/2 | Tan Triple Ceramic | 5LB | 4 | T25 | 509 | \$ 41.00 | \$ 0.08 |
| D8133-300 | MP813300 | #9 x 3 | Tan Triple Ceramic | 5LB | 4 | T25 | 431 | \$ 41.00 | \$ 0.10 |
| D8133-318 | MP813318 | #10 x 3-1/8 | Tan Triple Ceramic | 5LB | 4 | T25 | 330 | \$ 42.40 | \$ 0.13 |
| D8133-312 | MP813312 | #10 x 3-1/2 | Tan Triple Ceramic | 5LB | 4 | T25 | 303 | \$ 42.80 | \$ 0.14 |
| D8133-400 | MP813400 | #10 x 4 | Tan Triple Ceramic | 5LB | 4 | T25 | 266 | \$ 42.50 | \$ 0.16 |
| D8133-500 | MP813500 | #10 x 5 | Tan Triple Ceramic | 5LB | 4 | T25 | 215 | \$ 48.30 | \$ 0.22 |
| D8133-600 | MP813600 | #12 x 6 | Tan Triple Ceramic | 5LB | 4 | T25 | 120 | \$ 49.70 | \$ 0.41 |
| D8133-700 | MP813700 | #12 x 7 | Tan Triple Ceramic | 5LB | 4 | T25 | 105 | \$ 65.90 | \$ 0.63 |
| D8133-800 | MP813800 | #12 x 8 | Tan Triple Ceramic | 5LB | 4 | T25 | 95 | \$ 70.20 | \$ 0.74 |
| D8133-1000 | MP8131000 | #12 x 10 | Tan Triple Ceramic | 5LB | 4 | T25 | 75 | \$ 85.90 | \$ 1.15 |
| D8133-1200 | MP8131200 | #12 x 12 | Tan Triple Ceramic | 5LB | 4 | T25 | 65 | \$ 96.50 | \$ 1.48 |
| D8134-114 | MP814114 | #9 x 1-1/4 | Tan Triple Ceramic | 1/4 Keg | 1 | T25 | 5000 | \$ 170.20 | \$ 0.03 |
| D8134-158 | MP814158 | #9 x 1-5/8 | Tan Triple Ceramic | 1/4 Keg | 1 | T25 | 4500 | \$ 182.40 | \$ 0.04 |

*MSRP - Manufacturer's Suggested Retail Price is used to benchmark K9 Fasteners' value against competitive products.



TAN CERAMIC

| K9 Item # | Vendor # | Screw Size | Color | Pack Size | Case Pack | Bit | QTY/Pack | MSRP* | MSRP*/Ea. |
|-------------------|-----------|-------------|--------------------|-----------|-----------|-----|----------|-----------|-----------|
| D8134-200 | MP814200 | #9 x 2 | Tan Triple Ceramic | 1/4 Keg | 1 | T25 | 3500 | \$ 194.00 | \$ 0.06 |
| D8134-212 | MP814212 | #9 x 2-1/2 | Tan Triple Ceramic | 1/4 Keg | 1 | T25 | 2500 | \$ 172.00 | \$ 0.07 |
| D8134-300 | MP814300 | #9 x 3 | Tan Triple Ceramic | 1/4 Keg | 1 | T25 | 2000 | \$ 164.50 | \$ 0.08 |
| D8134-318 | MP814318 | #10 x 3-1/8 | Tan Triple Ceramic | 1/4 Keg | 1 | T25 | 1600 | \$ 178.10 | \$ 0.11 |
| D8134-312 | MP814312 | #10 x 3-1/2 | Tan Triple Ceramic | 1/4 Keg | 1 | T25 | 1500 | \$ 182.70 | \$ 0.12 |
| D8134-400 | MP814400 | #10 x 4 | Tan Triple Ceramic | 1/4 Keg | 1 | T25 | 1000 | \$ 144.70 | \$ 0.14 |
| D8134-500 | MP814500 | #10 x 5 | Tan Triple Ceramic | 1/4 Keg | 1 | T25 | 850 | \$ 175.00 | \$ 0.21 |
| D8134-600 | MP814600 | #12 x 6 | Tan Triple Ceramic | 1/4 Keg | 1 | T25 | 500 | \$ 181.20 | \$ 0.36 |
| D8134-700 | MP814700 | #12 x 7 | Tan Triple Ceramic | 1/4 Keg | 1 | T25 | 400 | \$ 229.70 | \$ 0.57 |
| D8134-800 | MP814800 | #12 x 8 | Tan Triple Ceramic | 1/4 Keg | 1 | T25 | 300 | \$ 204.80 | \$ 0.68 |
| D8134-1000 | MP8141000 | #12 x 10 | Tan Triple Ceramic | 1/4 Keg | 1 | T25 | 300 | \$ 296.80 | \$ 0.99 |
| D8134-1200 | MP8141200 | #12 x 12 | Tan Triple Ceramic | 1/4 Keg | 1 | T25 | 300 | \$ 384.90 | \$ 1.28 |

*MSRP - Manufacturer's Suggested Retail Price is used to benchmark K9 Fasteners' value against competitive products.



K9 Fastener Facts

STRONGER- Not only does K9 Fasteners apply 3 coats of ceramic protection but we also apply an additional yellow zinc plated base coating directly over our C1022 steel.

STRONGER- Our Doberman ASTM tests reveal over 1,900 lbs. of pull out force and over 2,600 lbs. of shank shear force on respective sizes. (Complete test data on page 10 of the catalog)

FASTER- Our customers testify that the 3x coating has an additional benefit of reducing drive resistance and torque which provides faster set times and longer battery life.

FASTER - In house tests reveal our Quick-bite tip cuts faster and starts faster than the competition.

VALUE- Many retailers who sell fasteners by the pound have stated that when merchandised alongside of competitors, K9 products out sell the competition 5 to 1.

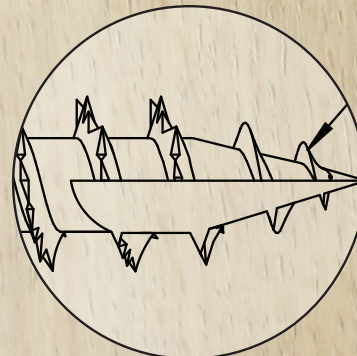
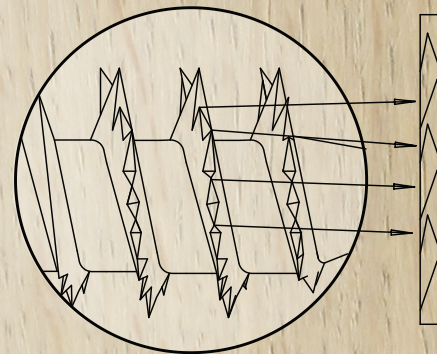
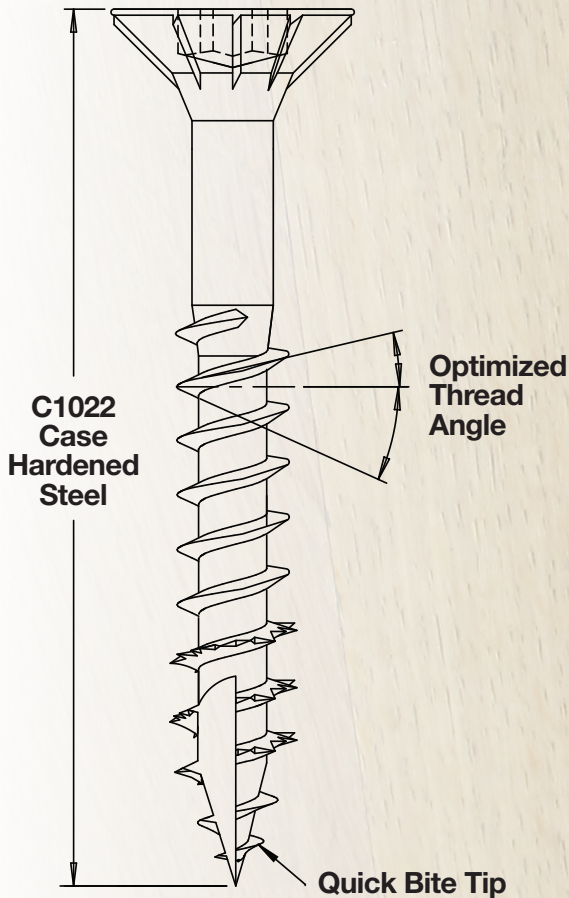
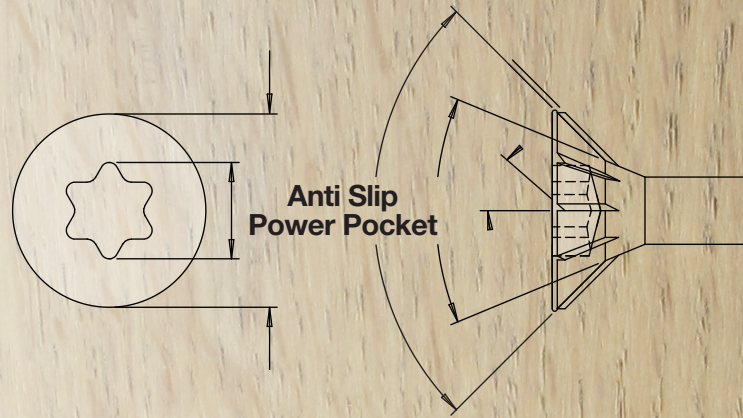
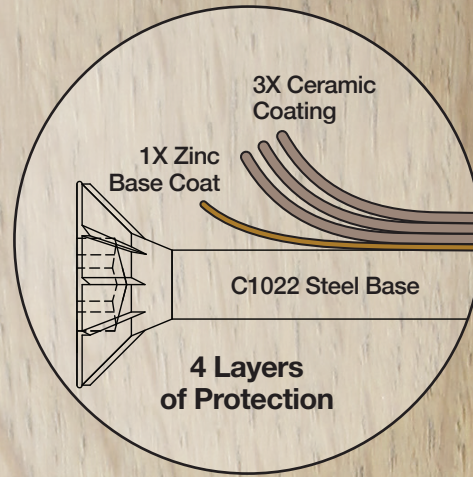

Huskie

Premium Construction Lag

Pulls more weight, holds more weight, and starts with ease.

- Quick-bite tip
- 3X ceramic protection
- Anti slip bit pocket
- T30 or T40 Power Bit included in every box



TAN CERAMIC

| K9 Item # | Vendor # | Screw Size | Color | Pack Size | Case Pack | Bit | QTY/Pack | MSRP* | MSRP*/Ea. |
|------------------|----------|--------------|--------------------|-----------|-----------|-----|----------|----------|-----------|
| H8233-114 | MP822114 | 5/16 x 1-1/4 | Tan Triple Ceramic | 5LB | 4 | T30 | 300 | \$ 44.90 | \$ 0.15 |
| H8233-212 | MP822212 | 5/16 x 2-1/2 | Tan Triple Ceramic | 5LB | 4 | T30 | 175 | \$ 42.40 | \$ 0.24 |
| H8233-300 | MP822300 | 5/16 x 3 | Tan Triple Ceramic | 5LB | 4 | T30 | 150 | \$ 42.40 | \$ 0.28 |
| H8233-312 | MP822312 | 5/16 x 3-1/2 | Tan Triple Ceramic | 5LB | 4 | T30 | 140 | \$ 42.40 | \$ 0.30 |
| H8233-400 | MP822400 | 5/16 x 4 | Tan Triple Ceramic | 5LB | 4 | T30 | 125 | \$ 42.40 | \$ 0.34 |
| H8233-500 | MP822500 | 5/16 x 5 | Tan Triple Ceramic | 5LB | 4 | T30 | 100 | \$ 47.70 | \$ 0.48 |
| H8233-600 | MP822600 | 5/16 x 6 | Tan Triple Ceramic | 5LB | 4 | T30 | 90 | \$ 52.20 | \$ 0.58 |
| H8233-800 | MP822800 | 3/8 x 8 | Tan Triple Ceramic | 5LB | 4 | T40 | 55 | \$ 73.20 | \$ 1.33 |

*MSRP - Manufacturer's Suggested Retail Price is used to benchmark K9 Fasteners' value against competitive products.



TAN CERAMIC

| K9 Item # | Vendor # | Screw Size | Color | Pack Size | Case Pack | Bit | QTY/Pack | MSRP* | MSRP*/Ea. |
|-------------------|-----------|--------------|--------------------|-----------|-----------|-----|----------|-----------|-----------|
| H8233-1000 | MP8221000 | 3/8 x 10 | Tan Triple Ceramic | 5LB | 4 | T40 | 45 | \$ 95.80 | \$ 2.13 |
| H8233-1200 | MP8221200 | 3/8 x 12 | Tan Triple Ceramic | 5LB | 4 | T40 | 38 | \$ 105.80 | \$ 2.78 |
| H8234-300 | MP823300 | 5/16 x 3 | Tan Triple Ceramic | 1/4 Keg | 1 | T30 | 600 | \$ 143.90 | \$ 0.24 |
| H8234-312 | MP823312 | 5/16 x 3-1/2 | Tan Triple Ceramic | 1/4 Keg | 1 | T30 | 500 | \$ 141.50 | \$ 0.28 |
| H8234-400 | MP823400 | 5/16 x 4 | Tan Triple Ceramic | 1/4 Keg | 1 | T30 | 400 | \$ 125.70 | \$ 0.31 |
| H8234-500 | MP823500 | 5/16 x 5 | Tan Triple Ceramic | 1/4 Keg | 1 | T30 | 350 | \$ 150.80 | \$ 0.43 |
| H8234-600 | MP823600 | 5/16 x 6 | Tan Triple Ceramic | 1/4 Keg | 1 | T30 | 300 | \$ 171.40 | \$ 0.57 |
| H8234-800 | MP823800 | 3/8 x 8 | Tan Triple Ceramic | 1/4 Keg | 1 | T40 | 200 | \$ 254.40 | \$ 1.27 |
| H8234-1000 | MP8231000 | 3/8 x 10 | Tan Triple Ceramic | 1/4 Keg | 1 | T40 | 180 | \$ 288.20 | \$ 1.60 |
| H8234-1200 | MP8231200 | 3/8 x 12 | Tan Triple Ceramic | 1/4 Keg | 1 | T40 | 150 | \$ 302.50 | \$ 2.02 |

K9 Fastener Facts

STRONGER- Our Huskie ASTM tests reveal over 3,400 lbs. of pull through force and over 4,700 lbs. of shank shear test force on respective sizes. (Complete test data on page 11 of the catalog)

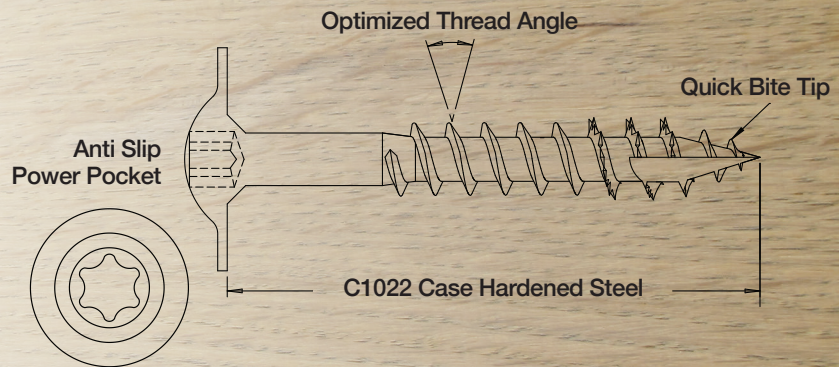

*MSRP - Manufacturer's Suggested Retail Price is used to benchmark K9 Fasteners' value against competitive products.



Greyhound

Premium Reverse Thread Trim Screw

Innovation in head design provides application options and stronger holding power.

- Quick-bite tip
- 3X ceramic protection
- Anti slip bit pocket
- Interior and exterior options
- T10 Power Bit included in every box



TAN CERAMIC - Ideal for exterior trim and railing

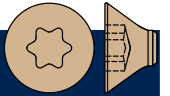

| K9 Item # | Vendor # | Screw Size | Color | Pack Size | Case Pack | Bit | QTY/Pack | MSRP* | MSRP*/Ea. |
|------------------|----------|------------|--------------------|-----------|-----------|-----|----------|----------|-----------|
| G8031-158 | MP833158 | #8 x 1-5/8 | Tan Triple Ceramic | 100 ct | 20 | T10 | 100 | \$ 8.80 | \$ 0.09 |
| G8031-200 | MP833200 | #8 x 2 | Tan Triple Ceramic | 100 ct | 20 | T10 | 100 | \$ 9.40 | \$ 0.09 |
| G8031-212 | MP833212 | #8 x 2-1/2 | Tan Triple Ceramic | 100 ct | 20 | T10 | 100 | \$ 10.50 | \$ 0.11 |
| G8031-300 | MP833300 | #8 x 3 | Tan Triple Ceramic | 100 ct | 20 | T10 | 100 | \$ 12.40 | \$ 0.12 |
| G8033-158 | MP834158 | #8 x 1-5/8 | Tan Triple Ceramic | 5LB | 4 | T10 | 1000 | \$ 44.50 | \$ 0.04 |
| G8033-200 | MP834200 | #8 x 2 | Tan Triple Ceramic | 5LB | 4 | T10 | 850 | \$ 44.50 | \$ 0.05 |
| G8033-212 | MP834212 | #8 x 2-1/2 | Tan Triple Ceramic | 5LB | 4 | T10 | 665 | \$ 44.50 | \$ 0.07 |
| G8033-300 | MP834300 | #8 x 3 | Tan Triple Ceramic | 5LB | 4 | T10 | 530 | \$ 47.60 | \$ 0.09 |

*MSRP - Manufacturer's Suggested Retail Price is used to benchmark K9 Fasteners' value against competitive products.



WHITE CERAMIC - Exterior use and composite applications

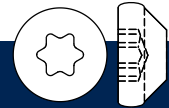

| K9 Item # | Vendor # | Screw Size | Color | Pack Size | Case Pack | Bit | QTY/Pack | MSRP* | MSRP*/Ea. |
|------------------|----------|------------|----------------------|-----------|-----------|-----|----------|----------|-----------|
| G8021-158 | MP830158 | #8 x 1-5/8 | White Triple Ceramic | 100 ct | 20 | T10 | 100 | \$ 8.80 | \$ 0.09 |
| G8021-200 | MP830200 | #8 x 2 | White Triple Ceramic | 100 ct | 20 | T10 | 100 | \$ 9.40 | \$ 0.09 |
| G8021-212 | MP830212 | #8 x 2-1/2 | White Triple Ceramic | 100 ct | 20 | T10 | 100 | \$ 10.50 | \$ 0.11 |
| G8021-300 | MP830300 | #8 x 3 | White Triple Ceramic | 100 ct | 20 | T10 | 100 | \$ 12.40 | \$ 0.12 |

K9 Fastener Facts

With many trim screws to choose from on the market consider the fact that Greyhound is the only line that gives you performance enhancements for various applications.

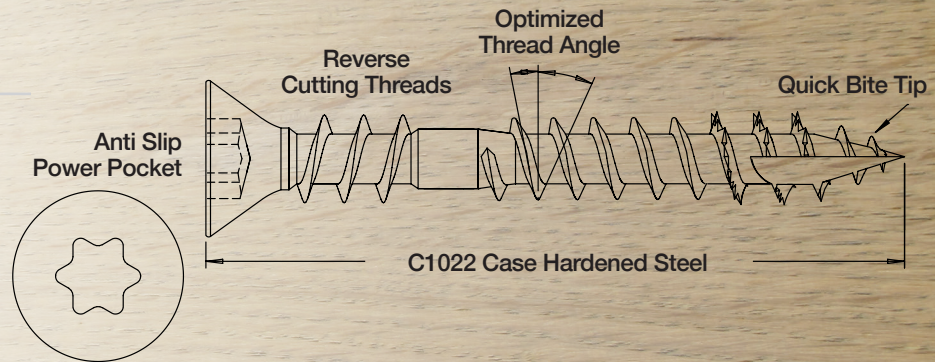

YELLOW ZINC - Numerous interior uses

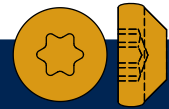

| K9 Item # | Vendor # | Screw Size | Color | Pack Size | Case Pack | Bit | QTY/Pack | MSRP* | MSRP*/Ea. |
|------------------|----------|------------|---------------|-----------|-----------|-----|----------|----------|-----------|
| G8011-158 | MP827158 | #8 x 1-5/8 | Yellow Zinc** | 100 ct | 20 | T10 | 100 | \$ 7.40 | \$ 0.07 |
| G8011-200 | MP827200 | #8 x 2 | Yellow Zinc** | 100 ct | 20 | T10 | 100 | \$ 8.50 | \$ 0.09 |
| G8011-212 | MP827212 | #8 x 2-1/2 | Yellow Zinc** | 100 ct | 20 | T10 | 100 | \$ 10.20 | \$ 0.10 |
| G8011-300 | MP827300 | #8 x 3 | Yellow Zinc** | 100 ct | 20 | T10 | 100 | \$ 11.40 | \$ 0.11 |

*MSRP - Manufacturer's Suggested Retail Price is used to benchmark K9 Fasteners' value against competitive products.
 **Yellow Zinc - Interior use only. Not intended for exterior use.



Doberman

Screw Performance Test

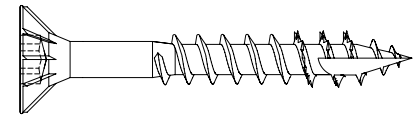
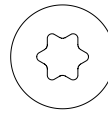

Material

- C1022 steel, yellow zinc plated
- Triple ceramic coated
- Certified for ACQ and all treated lumber

Package Sizes

- 1 lb. Box
- 5 lb. Box
- 1/4 Keg (approximate weight: 20-25 lbs.)

Pull Out Test – Performed per ASTM-D-1761 Standard. Measures the maximum force (in pounds) required to pull the fastener out of the wood while all of the threads are in the wood.

Pull Through Test – Performed per ETL 526848 Standard. Measures the maximum force (in pounds) required to pull the head of the fastener through the wood.

Shank Shear Test – Performed per ASTM –F - 606 Standard. Measures the force (in pounds) required to shear the shank of the fastener.

Passes a 2,160 (90-day) salt spray test, exceeding the AC257 salt spray requirements by 50%.

All tests were performed by an independent and accredited laboratory.

| Screw Size | Pull Out Test Average Max. Force | Pull Through Test Average Max. Force | Shank Shear Test Average Force to Shear Shank |
|-------------|-------------------------------------|---|--|
| #9 x 1 ¼" | 272 lbs. | 373 lbs. | 1,214 lbs. |
| #9 x 1 5/8" | 475 lbs. | 516 lbs. | 1,185 lbs. |
| #9 x 2" | 452 lbs. | 449 lbs. | 1,482 lbs. |
| #9 x 2 ½" | 672 lbs. | 533 lbs. | 1,125 lbs. |
| #9 x 3" | 811 lbs. | 327 lbs. | 1,138 lbs. |
| #10 x 3 ½" | 796 lbs. | 577 lbs. | 1,971 lbs. |
| #10 x 4" | 1,254 lbs. | 332 lbs. | 1,566 lbs. |
| #10 x 5" | 1,469 lbs. | 324 lbs. | 1,632 lbs. |
| #12 x 6" | 1,604 lbs. | 630 lbs. | 2,684 lbs. |
| #12 x 7" | 1,389 lbs. | 477 lbs. | 2,327 lbs. |
| #12 x 8" | 1,957 lbs. | 530 lbs. | 2,196 lbs. |
| #12 x 10" | 1,778 lbs. | 857 lbs. | 2,698 lbs. |
| #12 x 12" | 1,617 lbs. | 661 lbs. | 2,684 lbs. |



Huskie

Screw Performance Test

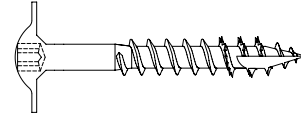
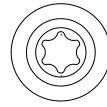

Material

- C1022 steel, yellow zinc plated
- Triple ceramic coated
- Certified for ACQ and all treated lumber

Package Sizes

- 5 lb. Box
- 1/4 Keg (approximate weight: 20-25 lbs.)

Pull Out Test – Performed per ASTM-D-1761 Standard. Measures the maximum force (in pounds) required to pull the fastener out of the wood while all of the threads are in the wood.

Pull Through Test – Performed per ETL 526848 Standard. Measures the maximum force (in pounds) required to pull the head of the fastener through the wood.

Shank Shear Test – Performed per ASTM –F - 606 Standard. Measures the force (in pounds) required to shear the shank of the fastener.

Passes a 2,160 (90-day) salt spray test, exceeding the AC257 salt spray requirements by 50%.

All tests were performed by an independent and accredited laboratory.

| Screw Size | Pull Out Test Average Max. Force | Pull Through Test Average Max. Force | Shank Shear Test Average Force to Shear Shank |
|----------------|-------------------------------------|---|--|
| 5/16" x 3 1/2" | 1,349 lbs. | 1,290 lbs. | 3,569 lbs. |
| 5/16" x 4" | 1,437 lbs. | 1,172 lbs. | 2,742 lbs. |
| 5/16" x 5" | 1,647 lbs. | 1,796 lbs. | 3,338 lbs. |
| 5/16" x 6" | 1,714 lbs. | 2,805 lbs. | 4,496 lbs. |
| 3/8" x 8" | 1,637 lbs. | 3,473 lbs. | 4,786 lbs. |
| 3/8" x 10" | 1,627 lbs. | 3,006 lbs. | 4,411 lbs. |
| 3/8" x 12" | 1,748 lbs. | 2,733 lbs. | 3,617 lbs. |



Power Bits & Nut Setters

Reverse Thread Trim Screw

Power Bits and nut setters provide the safest anti slip performance and unparalleled confidence

- 1" Power Bit insert included in every package
- Bright colors for fast identification
- K9 Power Bit Pocket optimized specifically for use with K9 Power Bits



1" Star Head Power Bit Insert

| K9 Item # | Vendor # | Description | Case Pack | MSRP* | MSRP*/Ea. |
|-----------|----------|-------------|-----------|--------|-----------|
| B2011-10 | MP20010 | T10 Purple | 10 | \$7.50 | \$ 0.75 |
| B2011-15 | MP20015 | T15 Blue | 10 | \$7.50 | \$ 0.75 |
| B2011-20 | MP20020 | T20 Green | 10 | \$7.50 | \$ 0.75 |
| B2011-25 | MP20025 | T25 Yellow | 10 | \$7.50 | \$ 0.75 |
| B2011-30 | MP20030 | T30 Orange | 10 | \$7.50 | \$ 0.75 |
| B2011-40 | MP20010 | T40 Red | 10 | \$7.50 | \$ 0.75 |

2" Star Head Power Bits

| K9 Item # | Vendor # | Description | Case Pack | MSRP* | MSRP*/Ea. |
|-----------|----------|-------------|-----------|---------|-----------|
| B2021-10 | MP20110 | T10 Purple | 10 | \$13.90 | \$ 1.39 |
| B2021-15 | MP20115 | T15 Blue | 10 | \$13.90 | \$ 1.39 |
| B2021-20 | MP20120 | T20 Green | 10 | \$13.90 | \$ 1.39 |
| B2021-25 | MP20125 | T25 Yellow | 10 | \$13.90 | \$ 1.39 |
| B2021-30 | MP20130 | T30 Orange | 10 | \$13.90 | \$ 1.39 |
| B2021-40 | MP20140 | T40 Red | 10 | \$13.90 | \$ 1.39 |

Magnetic Nut Setters

| K9 Item # | Vendor # | Description | Case Pack | MSRP* | MSRP*/Ea. |
|-----------|----------|--------------|-----------|---------|-----------|
| N3001-14 | MP20601 | 1/4" Blue | 10 | \$38.30 | \$ 3.83 |
| N3001-516 | MP20602 | 5/16" Yellow | 10 | \$42.90 | \$ 4.29 |
| N3001-38 | MP20603 | 3/8" Orange | 10 | \$46.10 | \$ 4.61 |
| N3001-716 | MP20604 | 7/16" Red | 10 | \$56.90 | \$ 5.69 |

*MSRP - Manufacturer's Suggested Retail Price is used to benchmark K9 Fasteners' value against competitive products.



K9 Fasteners Order Form

Company Name: _____

Shipping Address: _____

Company Phone: _____ Fax: _____

Email Address: _____ PO Number: _____

Order Date: _____

| Qty. | K9 Item # | Vendor # | Screw Size | Color | Pack Size | MSRP* | MSRP*/Ea. |
|------|------------|-----------|-------------|--------------------|-----------|-----------|-----------|
| | D8132-158 | MP812158 | #9 x 1-5/8 | Tan Triple Ceramic | 1LB | \$ 11.50 | \$ 0.07 |
| | D8132-200 | MP812200 | #9 x 2 | Tan Triple Ceramic | 1LB | \$ 11.50 | \$ 0.09 |
| | D8132-212 | MP812212 | #9 x 2-1/2 | Tan Triple Ceramic | 1LB | \$ 11.50 | \$ 0.12 |
| | D8132-300 | MP812300 | #9 x 3 | Tan Triple Ceramic | 1LB | \$ 11.50 | \$ 0.14 |
| | D8132-312 | MP812312 | #10 x 3-1/2 | Tan Triple Ceramic | 1LB | \$ 12.00 | \$ 0.20 |
| | D8133-114 | MP813114 | #9 x 1-1/4 | Tan Triple Ceramic | 5LB | \$ 41.30 | \$ 0.03 |
| | D8133-158 | MP813158 | #9 x 1-5/8 | Tan Triple Ceramic | 5LB | \$ 41.00 | \$ 0.04 |
| | D8133-200 | MP813200 | #9 x 2 | Tan Triple Ceramic | 5LB | \$ 40.40 | \$ 0.06 |
| | D8133-212 | MP813212 | #9 x 2-1/2 | Tan Triple Ceramic | 5LB | \$ 41.00 | \$ 0.08 |
| | D8133-300 | MP813300 | #9 x 3 | Tan Triple Ceramic | 5LB | \$ 41.00 | \$ 0.10 |
| | D8133-318 | MP813318 | #10 x 3-1/8 | Tan Triple Ceramic | 5LB | \$ 42.40 | \$ 0.13 |
| | D8133-312 | MP813312 | #10 x 3-1/2 | Tan Triple Ceramic | 5LB | \$ 42.80 | \$ 0.14 |
| | D8133-400 | MP813400 | #10 x 4 | Tan Triple Ceramic | 5LB | \$ 42.50 | \$ 0.16 |
| | D8133-500 | MP813500 | #10 x 5 | Tan Triple Ceramic | 5LB | \$ 48.30 | \$ 0.22 |
| | D8133-600 | MP813600 | #12 x 6 | Tan Triple Ceramic | 5LB | \$ 49.70 | \$ 0.41 |
| | D8133-700 | MP813700 | #12 x 7 | Tan Triple Ceramic | 5LB | \$ 65.90 | \$ 0.63 |
| | D8133-800 | MP813800 | #12 x 8 | Tan Triple Ceramic | 5LB | \$ 70.20 | \$ 0.74 |
| | D8133-1000 | MP8131000 | #12 x 10 | Tan Triple Ceramic | 5LB | \$ 85.90 | \$ 1.15 |
| | D8133-1200 | MP8131200 | #12 x 12 | Tan Triple Ceramic | 5LB | \$ 96.50 | \$ 1.48 |
| | D8134-114 | MP814114 | #9 x 1-1/4 | Tan Triple Ceramic | 1/4 Keg | \$ 170.20 | \$ 0.03 |
| | D8134-158 | MP814158 | #9 x 1-5/8 | Tan Triple Ceramic | 1/4 Keg | \$ 182.40 | \$ 0.04 |
| | D8134-200 | MP814200 | #9 x 2 | Tan Triple Ceramic | 1/4 Keg | \$ 194.00 | \$ 0.06 |
| | D8134-212 | MP814212 | #9 x 2-1/2 | Tan Triple Ceramic | 1/4 Keg | \$ 172.00 | \$ 0.07 |
| | D8134-300 | MP814300 | #9 x 3 | Tan Triple Ceramic | 1/4 Keg | \$ 164.50 | \$ 0.08 |
| | D8134-318 | MP814318 | #10 x 3-1/8 | Tan Triple Ceramic | 1/4 Keg | \$ 178.10 | \$ 0.11 |
| | D8134-312 | MP814312 | #10 x 3-1/2 | Tan Triple Ceramic | 1/4 Keg | \$ 182.70 | \$ 0.12 |
| | D8134-400 | MP814400 | #10 x 4 | Tan Triple Ceramic | 1/4 Keg | \$ 144.70 | \$ 0.14 |
| | D8134-500 | MP814500 | #10 x 5 | Tan Triple Ceramic | 1/4 Keg | \$ 175.00 | \$ 0.21 |
| | D8134-600 | MP814600 | #12 x 6 | Tan Triple Ceramic | 1/4 Keg | \$ 181.20 | \$ 0.36 |
| | D8134-700 | MP814700 | #12 x 7 | Tan Triple Ceramic | 1/4 Keg | \$ 229.70 | \$ 0.57 |
| | D8134-800 | MP814800 | #12 x 8 | Tan Triple Ceramic | 1/4 Keg | \$ 204.80 | \$ 0.68 |
| | D8134-1000 | MP8141000 | #12 x 10 | Tan Triple Ceramic | 1/4 Keg | \$ 296.80 | \$ 0.99 |
| | D8134-1200 | MP8141200 | #12 x 12 | Tan Triple Ceramic | 1/4 Keg | \$ 384.90 | \$ 1.28 |

*MSRP - Manufacturer's Suggested Retail Price is used to benchmark K9 Fasteners' value against competitive products.
For more products, continue on next page



Huskie, Greyhound, Bits & Nut Setter Items

Company Name: _____ Fax: _____
 Shipping Address: _____ Order Date: _____
 Email Address: _____ PO Number: _____

| Qty. | K9 Item # | Vendor # | Screw/Bit Size | Color | Pack Size | MSRP* | MSRP*/Ea. |
|------|------------|-----------|------------------|----------------------|-----------|-----------|-----------|
| | H8233-114 | MP822114 | 5/16 x 1-1/4 | Tan Triple Ceramic | 5LB | \$ 44.90 | \$ 0.15 |
| | H8233-212 | MP822212 | 5/16 x 2-1/2 | Tan Triple Ceramic | 5LB | \$ 42.40 | \$ 0.24 |
| | H8233-300 | MP822300 | 5/16 x 3 | Tan Triple Ceramic | 5LB | \$ 42.40 | \$ 0.28 |
| | H8233-312 | MP822312 | 5/16 x 3-1/2 | Tan Triple Ceramic | 5LB | \$ 42.40 | \$ 0.30 |
| | H8233-400 | MP822400 | 5/16 x 4 | Tan Triple Ceramic | 5LB | \$ 42.40 | \$ 0.34 |
| | H8233-500 | MP822500 | 5/16 x 5 | Tan Triple Ceramic | 5LB | \$ 47.70 | \$ 0.48 |
| | H8233-600 | MP822600 | 5/16 x 6 | Tan Triple Ceramic | 5LB | \$ 52.20 | \$ 0.58 |
| | H8233-800 | MP822800 | 3/8 x 8 | Tan Triple Ceramic | 5LB | \$ 73.20 | \$ 1.33 |
| | H8233-1000 | MP8221000 | 3/8 x 10 | Tan Triple Ceramic | 5LB | \$ 95.80 | \$ 2.13 |
| | H8233-1200 | MP8221200 | 3/8 x 12 | Tan Triple Ceramic | 5LB | \$ 105.80 | \$ 2.78 |
| | H8234-300 | MP823300 | 5/16 x 3 | Tan Triple Ceramic | 1/4 Keg | \$ 143.90 | \$ 0.24 |
| | H8234-312 | MP823312 | 5/16 x 3-1/2 | Tan Triple Ceramic | 1/4 Keg | \$ 141.50 | \$ 0.28 |
| | H8234-400 | MP823400 | 5/16 x 4 | Tan Triple Ceramic | 1/4 Keg | \$ 125.70 | \$ 0.31 |
| | H8234-500 | MP823500 | 5/16 x 5 | Tan Triple Ceramic | 1/4 Keg | \$ 150.80 | \$ 0.43 |
| | H8234-600 | MP823600 | 5/16 x 6 | Tan Triple Ceramic | 1/4 Keg | \$ 171.40 | \$ 0.57 |
| | H8234-800 | MP823800 | 3/8 x 8 | Tan Triple Ceramic | 1/4 Keg | \$ 254.40 | \$ 1.27 |
| | H8234-1000 | MP8231000 | 3/8 x 10 | Tan Triple Ceramic | 1/4 Keg | \$ 288.20 | \$ 1.60 |
| | H8234-1200 | MP8231200 | 3/8 x 12 | Tan Triple Ceramic | 1/4 Keg | \$ 302.50 | \$ 2.02 |
| | G8011-158 | MP827158 | #8 x 1-5/8 | Yellow Zinc | 100 ct | \$ 7.40 | \$ 0.07 |
| | G8011-200 | MP827200 | #8 x 2 | Yellow Zinc | 100 ct | \$ 8.50 | \$ 0.09 |
| | G8011-212 | MP827212 | #8 x 2-1/2 | Yellow Zinc | 100 ct | \$ 10.20 | \$ 0.10 |
| | G8011-300 | MP827300 | #8 x 3 | Yellow Zinc | 100 ct | \$ 11.40 | \$ 0.11 |
| | G8021-158 | MP830158 | #8 x 1-5/8 | White Triple Ceramic | 100 ct | \$ 8.80 | \$ 0.09 |
| | G8021-200 | MP830200 | #8 x 2 | White Triple Ceramic | 100 ct | \$ 9.40 | \$ 0.09 |
| | G8021-212 | MP830212 | #8 x 2-1/2 | White Triple Ceramic | 100 ct | \$ 10.50 | \$ 0.11 |
| | G8021-300 | MP830300 | #8 x 3 | White Triple Ceramic | 100 ct | \$ 12.40 | \$ 0.12 |
| | G8031-158 | MP833158 | #8 x 1-5/8 | Tan Triple Ceramic | 100 ct | \$ 8.80 | \$ 0.09 |
| | G8031-200 | MP833200 | #8 x 2 | Tan Triple Ceramic | 100 ct | \$ 9.40 | \$ 0.09 |
| | G8031-212 | MP833212 | #8 x 2-1/2 | Tan Triple Ceramic | 100 ct | \$ 10.50 | \$ 0.11 |
| | G8031-300 | MP833300 | #8 x 3 | Tan Triple Ceramic | 100 ct | \$ 12.40 | \$ 0.12 |
| | G8033-158 | MP834158 | #8 x 1-5/8 | Tan Triple Ceramic | 5LB | \$ 44.50 | \$ 0.04 |
| | G8033-200 | MP834200 | #8 x 2 | Tan Triple Ceramic | 5LB | \$ 44.50 | \$ 0.05 |
| | G8033-212 | MP834212 | #8 x 2-1/2 | Tan Triple Ceramic | 5LB | \$ 44.50 | \$ 0.07 |
| | G8033-300 | MP834300 | #8 x 3 | Tan Triple Ceramic | 5LB | \$ 47.60 | \$ 0.09 |
| | B2011-10 | MP20010 | T10 1" Power Bit | T10 Purple | 10/pack | \$ 7.50 | \$ 0.75 |
| | B2011-15 | MP20015 | T15 1" Power Bit | T15 Blue | 10/pack | \$ 7.50 | \$ 0.75 |
| | B2011-20 | MP20020 | T20 1" Power Bit | T20 Green | 10/pack | \$ 7.50 | \$ 0.75 |
| | B2011-25 | MP20025 | T25 1" Power Bit | T25 Yellow | 10/pack | \$ 7.50 | \$ 0.75 |
| | B2011-30 | MP20030 | T30 1" Power Bit | T30 Orange | 10/pack | \$ 7.50 | \$ 0.75 |
| | B2011-40 | MP20040 | T40 1" Power Bit | T40 Red | 10/pack | \$ 7.50 | \$ 0.75 |
| | B2021-10 | MP20110 | T10 2" Power Bit | T10 Purple | 10/pack | \$ 13.90 | \$ 1.39 |
| | B2021-15 | MP20115 | T15 2" Power Bit | T15 Blue | 10/pack | \$ 13.90 | \$ 1.39 |
| | B2021-20 | MP20120 | T20 2" Power Bit | T20 Green | 10/pack | \$ 13.90 | \$ 1.39 |
| | B2021-25 | MP20125 | T25 2" Power Bit | T25 Yellow | 10/pack | \$ 13.90 | \$ 1.39 |
| | B2021-30 | MP20130 | T30 2" Power Bit | T30 Orange | 10/pack | \$ 13.90 | \$ 1.39 |
| | B2021-40 | MP20140 | T40 2" Power Bit | T40 Red | 10/pack | \$ 13.90 | \$ 1.39 |
| | N3001-14 | MP20601 | 1/4" | 1/4" Blue | 10/pack | \$ 38.30 | \$ 3.83 |
| | N3001-516 | MP20602 | 5/16" | 5/16" Yellow | 10/pack | \$ 42.90 | \$ 4.29 |
| | N3001-38 | MP20603 | 3/8" | 3/8" Orange | 10/pack | \$ 46.10 | \$ 4.61 |
| | N3001-716 | MP20604 | 7/16" | 7/16" Red | 10/pack | \$ 56.90 | \$ 5.69 |



ORDERING FROM K9 Fasteners

- Prices are subject to change without notice. For up-to-date pricing, visit www.k9fasteners.com.
- To ensure 100% accuracy orders are preferred via fax, e-mail, or online at www.k9fasteners.com.
- Shipping charges appear on your sales order confirmation.

ORDERING TERMS

- Approved credit application, sales tax #, W9 and references are required to establish a new account.
- Invoice terms are NET 30 days, aged from invoice date. Past-due accounts are charged 1½% per month on past-due amounts. Orders from past-due accounts are put on hold.

SHIPPING TERMS

- Shipments are prepaid at \$700 NET for orders shipped within the continental United States.
- Orders less than \$700 will have ground shipping charges added to the invoice.
- Delivery charges for orders shipped to Alaska and Hawaii will be quoted prior to shipment.
- K9 Fasteners will select the carrier for all shipments.
- A \$10 drop-ship fee will be added to all orders shipped directly to a residence or a retailers customer.

PICKUPS

- We do not have counter service

RETURNS/CREDITS/SHIPPING ERRORS

- A Return Merchandise Authorization (RMA) is required for all returns.
- Customers have 30 days to request a RMA from our customer service department.
- Product must be returned within 10 days after receipt of the RMA.
- Returns for any reason other than manufacturer defect or K9 Fasteners error are subject to a 15% restocking fee.
- In all instances, the product must be returned in saleable condition, in the original packaging and inside an outer carton. Any return with price stickers, label damage or other package damage will be rejected.
- All claims for shortage and/or damaged goods must be reported within five days from receipt of merchandise.

Business Hours 8:00 AM to 5:00 PM Central Time

PLEASE BE ADVISED

- Possession of this catalog does not constitute permission to purchase or an obligation to sell.
- Product prices are subject to change without notice.
- Prepaid shipping minimum subject to change.





HAPPY ANNIVERSARY

2019 marked 10 years of success for K9 fasteners. We have hundreds of retailers and thousands of builders that choose the loyalty, value and performance of our fasteners every single day. Experience for yourself how Doberman, Huskie and Greyhound products are Faster, Stronger, and Safer!

Hours & Location:

8:00 AM to 5:00 PM Central Time

PO Box 2673
Appleton, WI 54912

Tel: 888.205.2355
Fax: 888.839.5997

VISIT US AT:
www.k9fasteners.com

©1039 K9 Fasteners

"K9 Fasteners have really caught on over the past 6 years. Our customers love them because they are the best value compared to the over-priced competition."

*- R.C. Goodwyn & Sons
Powhatan, VA*

"There are many reasons to choose K9 Fasteners but the fast starts, ceramic coating and product strength have made both Doberman deck screws and Huskie lags a winner for us for many years."

*- Beaver Builders Supply Inc.
Holmen, WI*

"I have NEVER-EVER had a performance problem in the 9 years I have sold K9. This product is a GREAT value for me and my customers."

*- Hennen Lumber Company
Freeport, MN*

"K9 fasteners are the real deal. They don't snap off like other brands when put to the true test in the field, they're faster, and less expensive than the competition"

*- Ethan Coop Lumber
Ethan, SD*

"For us, the K9 fastener is a high performance product at a good price point. We like the 1# & 5 # packaging for merchandising and display. The K9 fastener program has been a good fit for the How To Building Center."

*- Farmers Co-op Society
Sioux Center, IA*

"Good quality product at the best price. We have not found anything better than K9 anywhere else."

*- Pioneer General Store
Mio MI*

JOIN THE PACK!