



K9 FASTENERS®

PRODUCT CATALOG



FASTER

- Faster Start
- Faster Set
- Less Torque



STRONGER

- Stronger Ceramic Coating
- Stronger Protection
- Treated Lumber Approved



SAFER

- Safer Power Bit Pocket
- Safer Hold
- Anti Slip Performance

Order Online

Need current pricing? Working late? Want answers quickly?

With our easy-to-use web store, you can place orders, view pricing and much more!

Visit www.k9fasteners.com and click **SHOP NOW** to get started!

- View your current pricing and real-time product inventory
- Access order status and tracking information
- See your order history
- View outstanding and available balances

Not a current Web store user? Signing up is easy.

Fill out the form at: www.k9fasteners.com/account/register

If you are not a current K9 Fasteners customer, please contact us at 888.205.2355

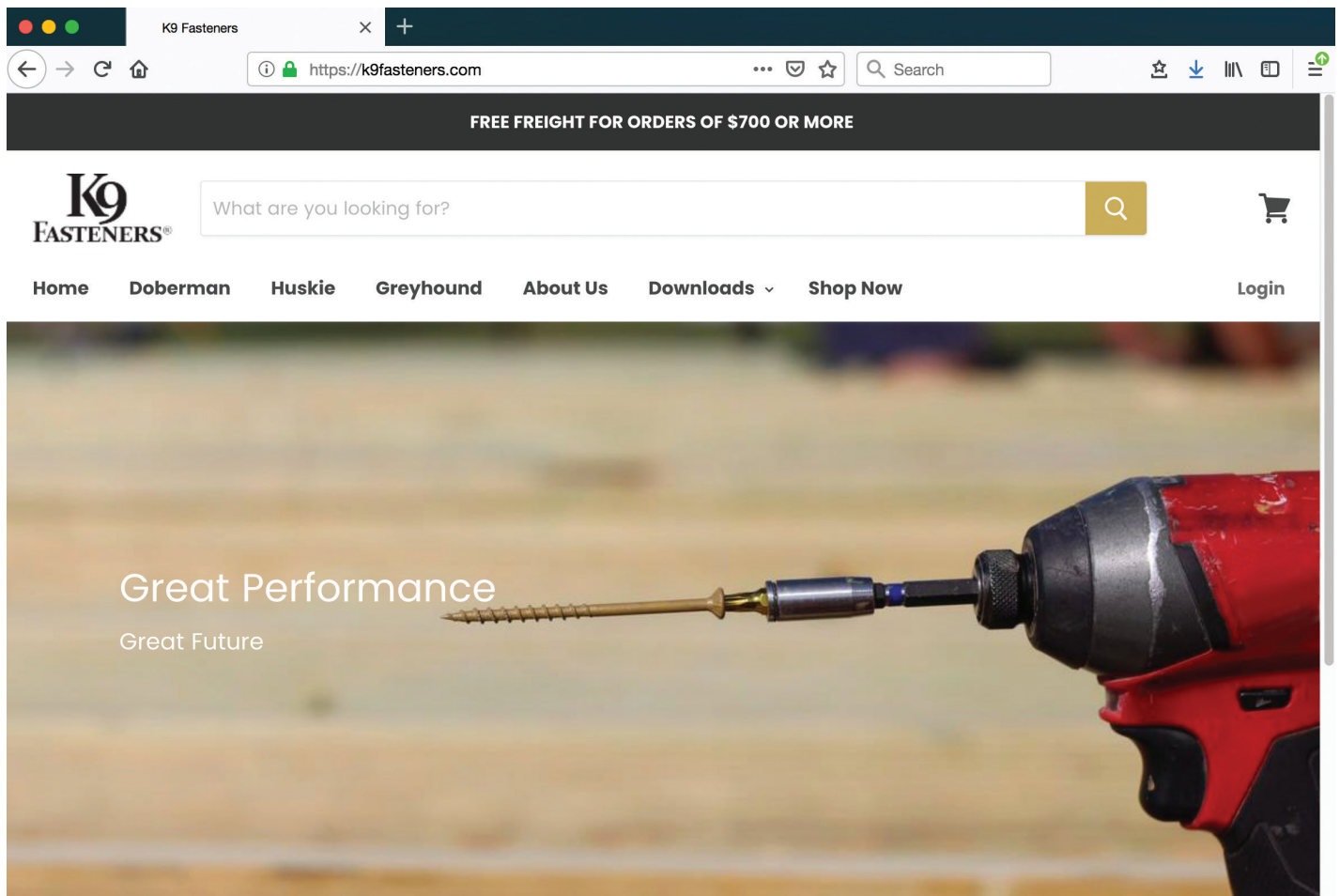
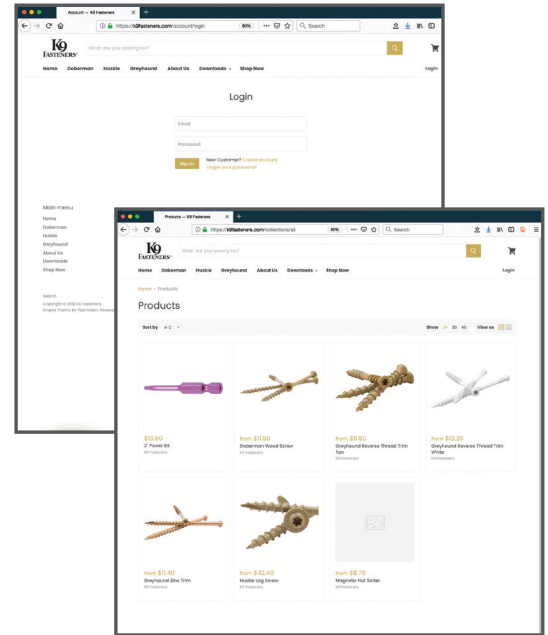



All of us here at K9 are thrilled to have this opportunity to continue the legacy of loyalty, value and performance that thousands of professionals have come to depend on. Notably, 2019 marked the 10 year anniversary of diligence and continuous improvement within the K9 line of products.

K9's fresh vision offers a renewed focus on your success. Based on market surveys, we are confident in our high market value. Whether you are new to K9 products or have chosen to exclusively provide k9 products to your customers, we all look forward to continued business growth. By incorporating new product branding, updated website design, and efficient online ordering, we are leading growth at K9.

We appreciate you being a part of the "PACK" as we look ahead to an exciting future together.

Sincerely,
K9 Sales Team



Doberman Premium Deck Screw page 2 - 5



Huskie Premium Construction Lag page 6 - 7



Greyhound Premium Trim Screw page 8 - 9

Performance Test page 10 - 11

Power Bits & Nut Setters page 12

Order Form & Info page 13 - 14



Doberman

Premium Deck Screw

Hardest working and loyal dog in the fight.

- Quick-bite tip
- 3X ceramic protection
- Anti slip bit pocket
- T25 Power Bit included in every box

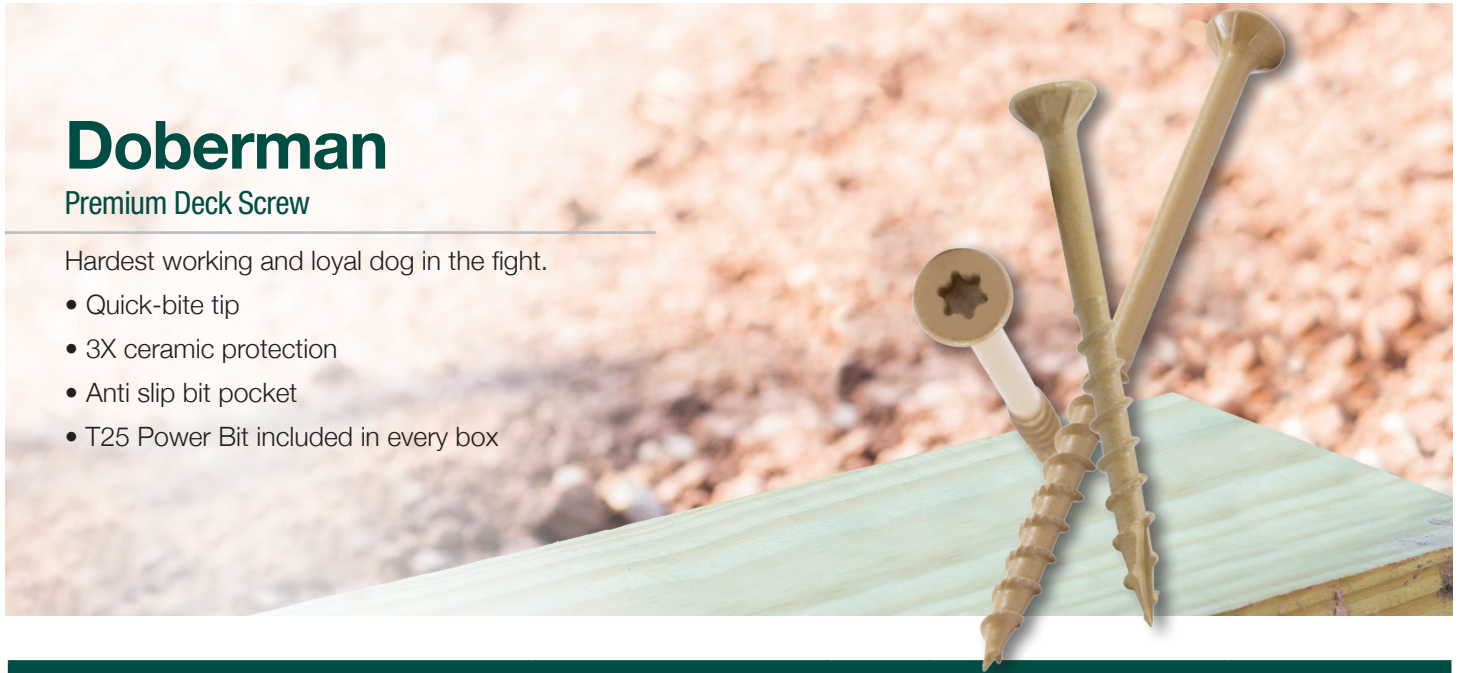

TAN CERAMIC

K9 Item #	Vendor #	Screw Size	Color	Pack Size	Case Pack	Bit	QTY/Pack	MSRP*	MSRP*/Ea.
D8132-158	MP812158	#9 x 1-5/8	Tan Triple Ceramic	1LB	20	T25	155	\$ 11.50	\$ 0.07
D8132-200	MP812200	#9 x 2	Tan Triple Ceramic	1LB	20	T25	125	\$ 11.50	\$ 0.09
D8132-212	MP812212	#9 x 2-1/2	Tan Triple Ceramic	1LB	20	T25	100	\$ 11.50	\$ 0.12
D8132-300	MP812300	#9 x 3	Tan Triple Ceramic	1LB	20	T25	85	\$ 11.50	\$ 0.14
D8132-312	MP812312	#10 x 3-1/2	Tan Triple Ceramic	1LB	20	T25	60	\$ 12.00	\$ 0.20
D8133-114	MP813114	#9 x 1-1/4	Tan Triple Ceramic	5LB	4	T25	1250	\$ 41.30	\$ 0.03
D8133-158	MP813158	#9 x 1-5/8	Tan Triple Ceramic	5LB	4	T25	923	\$ 41.00	\$ 0.04
D8133-200	MP813200	#9 x 2	Tan Triple Ceramic	5LB	4	T25	624	\$ 40.40	\$ 0.06

*MSRP - Manufacturer's Suggested Retail Price is used to benchmark K9 Fasteners' value against competitive products.



TAN CERAMIC

K9 Item #	Vendor #	Screw Size	Color	Pack Size	Case Pack	Bit	QTY/Pack	MSRP*	MSRP*/Ea.
D8133-212	MP813212	#9 x 2-1/2	Tan Triple Ceramic	5LB	4	T25	509	\$ 41.00	\$ 0.08
D8133-300	MP813300	#9 x 3	Tan Triple Ceramic	5LB	4	T25	431	\$ 41.00	\$ 0.10
D8133-318	MP813318	#10 x 3-1/8	Tan Triple Ceramic	5LB	4	T25	330	\$ 42.40	\$ 0.13
D8133-312	MP813312	#10 x 3-1/2	Tan Triple Ceramic	5LB	4	T25	303	\$ 42.80	\$ 0.14
D8133-400	MP813400	#10 x 4	Tan Triple Ceramic	5LB	4	T25	266	\$ 42.50	\$ 0.16
D8133-500	MP813500	#10 x 5	Tan Triple Ceramic	5LB	4	T25	215	\$ 48.30	\$ 0.22
D8133-600	MP813600	#12 x 6	Tan Triple Ceramic	5LB	4	T25	120	\$ 49.70	\$ 0.41
D8133-700	MP813700	#12 x 7	Tan Triple Ceramic	5LB	4	T25	105	\$ 65.90	\$ 0.63
D8133-800	MP813800	#12 x 8	Tan Triple Ceramic	5LB	4	T25	95	\$ 70.20	\$ 0.74
D8133-1000	MP8131000	#12 x 10	Tan Triple Ceramic	5LB	4	T25	75	\$ 85.90	\$ 1.15
D8133-1200	MP8131200	#12 x 12	Tan Triple Ceramic	5LB	4	T25	65	\$ 96.50	\$ 1.48
D8134-114	MP814114	#9 x 1-1/4	Tan Triple Ceramic	1/4 Keg	1	T25	5000	\$ 170.20	\$ 0.03
D8134-158	MP814158	#9 x 1-5/8	Tan Triple Ceramic	1/4 Keg	1	T25	4500	\$ 182.40	\$ 0.04

*MSRP - Manufacturer's Suggested Retail Price is used to benchmark K9 Fasteners' value against competitive products.



TAN CERAMIC

K9 Item #	Vendor #	Screw Size	Color	Pack Size	Case Pack	Bit	QTY/Pack	MSRP*	MSRP*/Ea.
D8134-200	MP814200	#9 x 2	Tan Triple Ceramic	1/4 Keg	1	T25	3500	\$ 194.00	\$ 0.06
D8134-212	MP814212	#9 x 2-1/2	Tan Triple Ceramic	1/4 Keg	1	T25	2500	\$ 172.00	\$ 0.07
D8134-300	MP814300	#9 x 3	Tan Triple Ceramic	1/4 Keg	1	T25	2000	\$ 164.50	\$ 0.08
D8134-318	MP814318	#10 x 3-1/8	Tan Triple Ceramic	1/4 Keg	1	T25	1600	\$ 178.10	\$ 0.11
D8134-312	MP814312	#10 x 3-1/2	Tan Triple Ceramic	1/4 Keg	1	T25	1500	\$ 182.70	\$ 0.12
D8134-400	MP814400	#10 x 4	Tan Triple Ceramic	1/4 Keg	1	T25	1000	\$ 144.70	\$ 0.14
D8134-500	MP814500	#10 x 5	Tan Triple Ceramic	1/4 Keg	1	T25	850	\$ 175.00	\$ 0.21
D8134-600	MP814600	#12 x 6	Tan Triple Ceramic	1/4 Keg	1	T25	500	\$ 181.20	\$ 0.36
D8134-700	MP814700	#12 x 7	Tan Triple Ceramic	1/4 Keg	1	T25	400	\$ 229.70	\$ 0.57
D8134-800	MP814800	#12 x 8	Tan Triple Ceramic	1/4 Keg	1	T25	300	\$ 204.80	\$ 0.68
D8134-1000	MP8141000	#12 x 10	Tan Triple Ceramic	1/4 Keg	1	T25	300	\$ 296.80	\$ 0.99
D8134-1200	MP8141200	#12 x 12	Tan Triple Ceramic	1/4 Keg	1	T25	300	\$ 384.90	\$ 1.28

*MSRP - Manufacturer's Suggested Retail Price is used to benchmark K9 Fasteners' value against competitive products.



K9 Fastener Facts

STRONGER- Not only does K9 Fasteners apply 3 coats of ceramic protection but we also apply an additional yellow zinc plated base coating directly over our C1022 steel.

STRONGER- Our Doberman ASTM tests reveal over 1,900 lbs. of pull out force and over 2,600 lbs. of shank shear force on respective sizes. (Complete test data on page 10 of the catalog)

FASTER- Our customers testify that the 3x coating has an additional benefit of reducing drive resistance and torque which provides faster set times and longer battery life.

FASTER - In house tests reveal our Quick-bite tip cuts faster and starts faster than the competition.

VALUE- Many retailers who sell fasteners by the pound have stated that when merchandised alongside of competitors, K9 products out sell the competition 5 to 1.

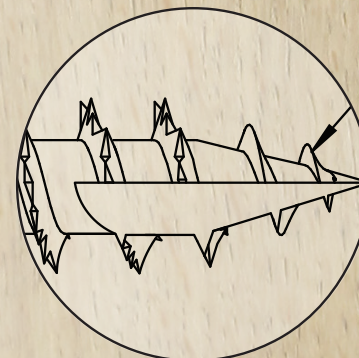
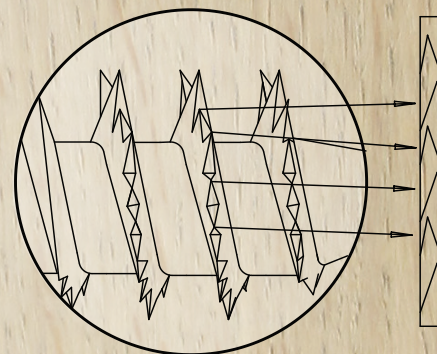
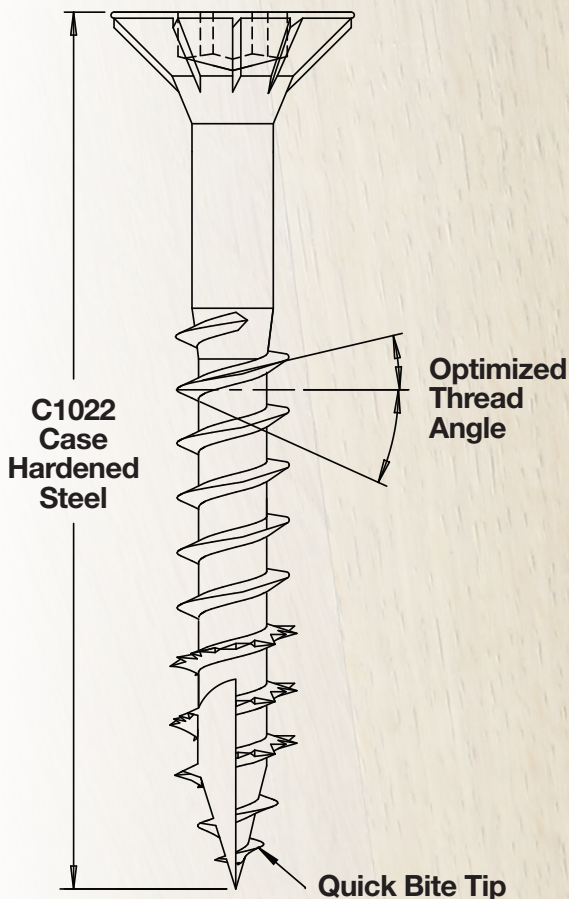
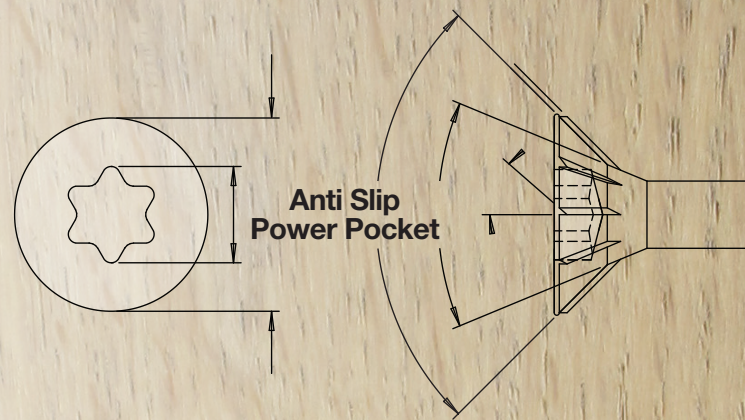
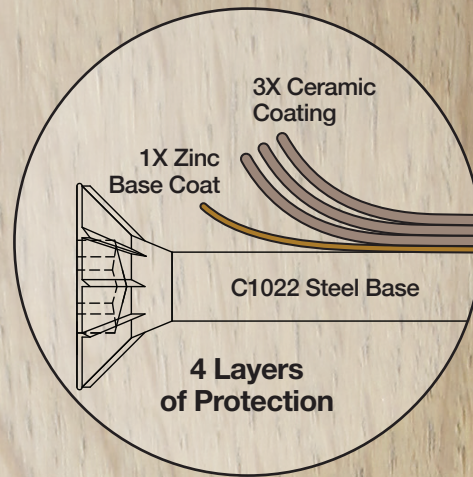

Huskie

Premium Construction Lag

Pulls more weight, holds more weight, and starts with ease.

- Quick-bite tip
- 3X ceramic protection
- Anti slip bit pocket
- T30 or T40 Power Bit included in every box



TAN CERAMIC

K9 Item #	Vendor #	Screw Size	Color	Pack Size	Case Pack	Bit	QTY/Pack	MSRP*	MSRP*/Ea.
H8233-114	MP822114	5/16 x 1-1/4	Tan Triple Ceramic	5LB	4	T30	300	\$ 44.90	\$ 0.15
H8233-212	MP822212	5/16 x 2-1/2	Tan Triple Ceramic	5LB	4	T30	175	\$ 42.40	\$ 0.24
H8233-300	MP822300	5/16 x 3	Tan Triple Ceramic	5LB	4	T30	150	\$ 42.40	\$ 0.28
H8233-312	MP822312	5/16 x 3-1/2	Tan Triple Ceramic	5LB	4	T30	140	\$ 42.40	\$ 0.30
H8233-400	MP822400	5/16 x 4	Tan Triple Ceramic	5LB	4	T30	125	\$ 42.40	\$ 0.34
H8233-500	MP822500	5/16 x 5	Tan Triple Ceramic	5LB	4	T30	100	\$ 47.70	\$ 0.48
H8233-600	MP822600	5/16 x 6	Tan Triple Ceramic	5LB	4	T30	90	\$ 52.20	\$ 0.58
H8233-800	MP822800	3/8 x 8	Tan Triple Ceramic	5LB	4	T40	55	\$ 73.20	\$ 1.33

*MSRP - Manufacturer's Suggested Retail Price is used to benchmark K9 Fasteners' value against competitive products.



TAN CERAMIC

K9 Item #	Vendor #	Screw Size	Color	Pack Size	Case Pack	Bit	QTY/Pack	MSRP*	MSRP*/Ea.
H8233-1000	MP8221000	3/8 x 10	Tan Triple Ceramic	5LB	4	T40	45	\$ 95.80	\$ 2.13
H8233-1200	MP8221200	3/8 x 12	Tan Triple Ceramic	5LB	4	T40	38	\$ 105.80	\$ 2.78
H8234-300	MP823300	5/16 x 3	Tan Triple Ceramic	1/4 Keg	1	T30	600	\$ 143.90	\$ 0.24
H8234-312	MP823312	5/16 x 3-1/2	Tan Triple Ceramic	1/4 Keg	1	T30	500	\$ 141.50	\$ 0.28
H8234-400	MP823400	5/16 x 4	Tan Triple Ceramic	1/4 Keg	1	T30	400	\$ 125.70	\$ 0.31
H8234-500	MP823500	5/16 x 5	Tan Triple Ceramic	1/4 Keg	1	T30	350	\$ 150.80	\$ 0.43
H8234-600	MP823600	5/16 x 6	Tan Triple Ceramic	1/4 Keg	1	T30	300	\$ 171.40	\$ 0.57
H8234-800	MP823800	3/8 x 8	Tan Triple Ceramic	1/4 Keg	1	T40	200	\$ 254.40	\$ 1.27
H8234-1000	MP8231000	3/8 x 10	Tan Triple Ceramic	1/4 Keg	1	T40	180	\$ 288.20	\$ 1.60
H8234-1200	MP8231200	3/8 x 12	Tan Triple Ceramic	1/4 Keg	1	T40	150	\$ 302.50	\$ 2.02

K9 Fastener Facts

STRONGER- Our Huskie ASTM tests reveal over 3,400 lbs. of pull through force and over 4,700 lbs. of shank shear test force on respective sizes. (Complete test data on page 11 of the catalog)

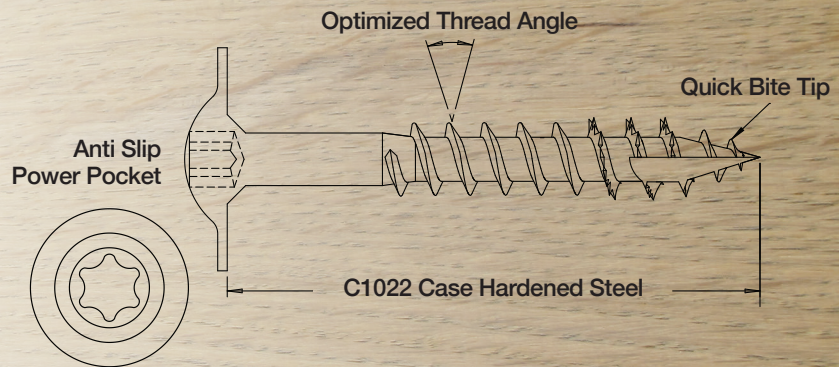

*MSRP - Manufacturer's Suggested Retail Price is used to benchmark K9 Fasteners' value against competitive products.



Greyhound

Premium Reverse Thread Trim Screw

Innovation in head design provides application options and stronger holding power.

- Quick-bite tip
- 3X ceramic protection
- Anti slip bit pocket
- Interior and exterior options
- T10 Power Bit included in every box



TAN CERAMIC - Ideal for exterior trim and railing

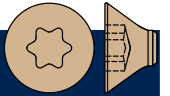

K9 Item #	Vendor #	Screw Size	Color	Pack Size	Case Pack	Bit	QTY/Pack	MSRP*	MSRP*/Ea.
G8031-158	MP833158	#8 x 1-5/8	Tan Triple Ceramic	100 ct	20	T10	100	\$ 8.80	\$ 0.09
G8031-200	MP833200	#8 x 2	Tan Triple Ceramic	100 ct	20	T10	100	\$ 9.40	\$ 0.09
G8031-212	MP833212	#8 x 2-1/2	Tan Triple Ceramic	100 ct	20	T10	100	\$ 10.50	\$ 0.11
G8031-300	MP833300	#8 x 3	Tan Triple Ceramic	100 ct	20	T10	100	\$ 12.40	\$ 0.12
G8033-158	MP834158	#8 x 1-5/8	Tan Triple Ceramic	5LB	4	T10	1000	\$ 44.50	\$ 0.04
G8033-200	MP834200	#8 x 2	Tan Triple Ceramic	5LB	4	T10	850	\$ 44.50	\$ 0.05
G8033-212	MP834212	#8 x 2-1/2	Tan Triple Ceramic	5LB	4	T10	665	\$ 44.50	\$ 0.07
G8033-300	MP834300	#8 x 3	Tan Triple Ceramic	5LB	4	T10	530	\$ 47.60	\$ 0.09

*MSRP - Manufacturer's Suggested Retail Price is used to benchmark K9 Fasteners' value against competitive products.



WHITE CERAMIC - Exterior use and composite applications

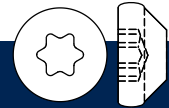

K9 Item #	Vendor #	Screw Size	Color	Pack Size	Case Pack	Bit	QTY/Pack	MSRP*	MSRP*/Ea.
G8021-158	MP830158	#8 x 1-5/8	White Triple Ceramic	100 ct	20	T10	100	\$ 8.80	\$ 0.09
G8021-200	MP830200	#8 x 2	White Triple Ceramic	100 ct	20	T10	100	\$ 9.40	\$ 0.09
G8021-212	MP830212	#8 x 2-1/2	White Triple Ceramic	100 ct	20	T10	100	\$ 10.50	\$ 0.11
G8021-300	MP830300	#8 x 3	White Triple Ceramic	100 ct	20	T10	100	\$ 12.40	\$ 0.12

K9 Fastener Facts

With many trim screws to choose from on the market consider the fact that Greyhound is the only line that gives you performance enhancements for various applications.

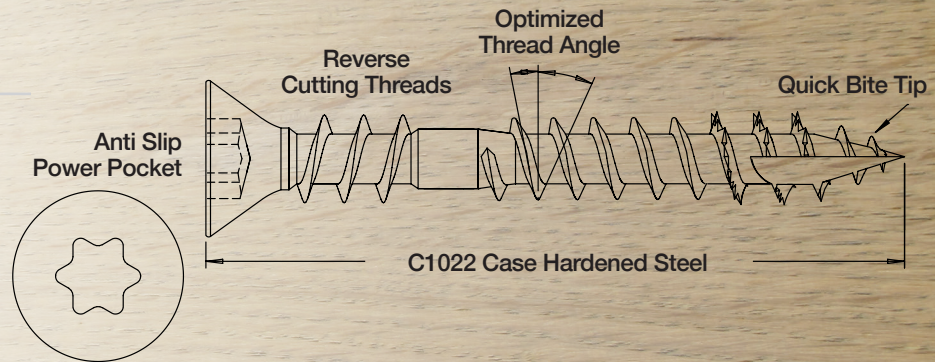

YELLOW ZINC - Numerous interior uses

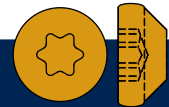

K9 Item #	Vendor #	Screw Size	Color	Pack Size	Case Pack	Bit	QTY/Pack	MSRP*	MSRP*/Ea.
G8011-158	MP827158	#8 x 1-5/8	Yellow Zinc**	100 ct	20	T10	100	\$ 7.40	\$ 0.07
G8011-200	MP827200	#8 x 2	Yellow Zinc**	100 ct	20	T10	100	\$ 8.50	\$ 0.09
G8011-212	MP827212	#8 x 2-1/2	Yellow Zinc**	100 ct	20	T10	100	\$ 10.20	\$ 0.10
G8011-300	MP827300	#8 x 3	Yellow Zinc**	100 ct	20	T10	100	\$ 11.40	\$ 0.11

*MSRP - Manufacturer's Suggested Retail Price is used to benchmark K9 Fasteners' value against competitive products.
 **Yellow Zinc - Interior use only. Not intended for exterior use.



Doberman

Screw Performance Test

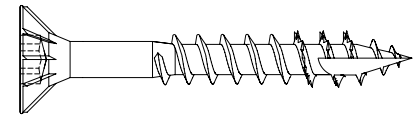
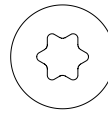

Material

- C1022 steel, yellow zinc plated
- Triple ceramic coated
- Certified for ACQ and all treated lumber

Package Sizes

- 1 lb. Box
- 5 lb. Box
- 1/4 Keg (approximate weight: 20-25 lbs.)

Pull Out Test – Performed per ASTM-D-1761 Standard. Measures the maximum force (in pounds) required to pull the fastener out of the wood while all of the threads are in the wood.

Pull Through Test – Performed per ETL 526848 Standard. Measures the maximum force (in pounds) required to pull the head of the fastener through the wood.

Shank Shear Test – Performed per ASTM –F - 606 Standard. Measures the force (in pounds) required to shear the shank of the fastener.

Passes a 2,160 (90-day) salt spray test, exceeding the AC257 salt spray requirements by 50%.

All tests were performed by an independent and accredited laboratory.

Screw Size	Pull Out Test Average Max. Force	Pull Through Test Average Max. Force	Shank Shear Test Average Force to Shear Shank
#9 x 1 ¼"	272 lbs.	373 lbs.	1,214 lbs.
#9 x 1 5/8"	475 lbs.	516 lbs.	1,185 lbs.
#9 x 2"	452 lbs.	449 lbs.	1,482 lbs.
#9 x 2 ½"	672 lbs.	533 lbs.	1,125 lbs.
#9 x 3"	811 lbs.	327 lbs.	1,138 lbs.
#10 x 3 ½"	796 lbs.	577 lbs.	1,971 lbs.
#10 x 4"	1,254 lbs.	332 lbs.	1,566 lbs.
#10 x 5"	1,469 lbs.	324 lbs.	1,632 lbs.
#12 x 6"	1,604 lbs.	630 lbs.	2,684 lbs.
#12 x 7"	1,389 lbs.	477 lbs.	2,327 lbs.
#12 x 8"	1,957 lbs.	530 lbs.	2,196 lbs.
#12 x 10"	1,778 lbs.	857 lbs.	2,698 lbs.
#12 x 12"	1,617 lbs.	661 lbs.	2,684 lbs.



Huskie

Screw Performance Test

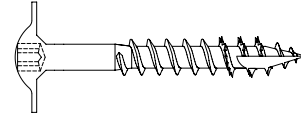
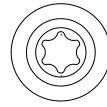

Material

- C1022 steel, yellow zinc plated
- Triple ceramic coated
- Certified for ACQ and all treated lumber

Package Sizes

- 5 lb. Box
- 1/4 Keg (approximate weight: 20-25 lbs.)

Pull Out Test – Performed per ASTM-D-1761 Standard. Measures the maximum force (in pounds) required to pull the fastener out of the wood while all of the threads are in the wood.

Pull Through Test – Performed per ETL 526848 Standard. Measures the maximum force (in pounds) required to pull the head of the fastener through the wood.

Shank Shear Test – Performed per ASTM –F - 606 Standard. Measures the force (in pounds) required to shear the shank of the fastener.

Passes a 2,160 (90-day) salt spray test, exceeding the AC257 salt spray requirements by 50%.

All tests were performed by an independent and accredited laboratory.

Screw Size	Pull Out Test Average Max. Force	Pull Through Test Average Max. Force	Shank Shear Test Average Force to Shear Shank
5/16" x 3 1/2"	1,349 lbs.	1,290 lbs.	3,569 lbs.
5/16" x 4"	1,437 lbs.	1,172 lbs.	2,742 lbs.
5/16" x 5"	1,647 lbs.	1,796 lbs.	3,338 lbs.
5/16" x 6"	1,714 lbs.	2,805 lbs.	4,496 lbs.
3/8" x 8"	1,637 lbs.	3,473 lbs.	4,786 lbs.
3/8" x 10"	1,627 lbs.	3,006 lbs.	4,411 lbs.
3/8" x 12"	1,748 lbs.	2,733 lbs.	3,617 lbs.



Power Bits & Nut Setters

Reverse Thread Trim Screw

Power Bits and nut setters provide the safest anti slip performance and unparalleled confidence

- 1" Power Bit insert included in every package
- Bright colors for fast identification
- K9 Power Bit Pocket optimized specifically for use with K9 Power Bits



1" Star Head Power Bit Insert

K9 Item #	Vendor #	Description	Case Pack	MSRP*	MSRP*/Ea.
B2011-10	MP20010	T10 Purple	10	\$7.50	\$ 0.75
B2011-15	MP20015	T15 Blue	10	\$7.50	\$ 0.75
B2011-20	MP20020	T20 Green	10	\$7.50	\$ 0.75
B2011-25	MP20025	T25 Yellow	10	\$7.50	\$ 0.75
B2011-30	MP20030	T30 Orange	10	\$7.50	\$ 0.75
B2011-40	MP20010	T40 Red	10	\$7.50	\$ 0.75

2" Star Head Power Bits

K9 Item #	Vendor #	Description	Case Pack	MSRP*	MSRP*/Ea.
B2021-10	MP20110	T10 Purple	10	\$13.90	\$ 1.39
B2021-15	MP20115	T15 Blue	10	\$13.90	\$ 1.39
B2021-20	MP20120	T20 Green	10	\$13.90	\$ 1.39
B2021-25	MP20125	T25 Yellow	10	\$13.90	\$ 1.39
B2021-30	MP20130	T30 Orange	10	\$13.90	\$ 1.39
B2021-40	MP20140	T40 Red	10	\$13.90	\$ 1.39

Magnetic Nut Setters

K9 Item #	Vendor #	Description	Case Pack	MSRP*	MSRP*/Ea.
N3001-14	MP20601	1/4" Blue	10	\$38.30	\$ 3.83
N3001-516	MP20602	5/16" Yellow	10	\$42.90	\$ 4.29
N3001-38	MP20603	3/8" Orange	10	\$46.10	\$ 4.61
N3001-716	MP20604	7/16" Red	10	\$56.90	\$ 5.69

*MSRP - Manufacturer's Suggested Retail Price is used to benchmark K9 Fasteners' value against competitive products.



K9 Fasteners Order Form

Company Name: _____

Shipping Address: _____

Company Phone: _____ Fax: _____

Email Address: _____ PO Number: _____

Order Date: _____

Qty.	K9 Item #	Vendor #	Screw Size	Color	Pack Size	MSRP*	MSRP*/Ea.
	D8132-158	MP812158	#9 x 1-5/8	Tan Triple Ceramic	1LB	\$ 11.50	\$ 0.07
	D8132-200	MP812200	#9 x 2	Tan Triple Ceramic	1LB	\$ 11.50	\$ 0.09
	D8132-212	MP812212	#9 x 2-1/2	Tan Triple Ceramic	1LB	\$ 11.50	\$ 0.12
	D8132-300	MP812300	#9 x 3	Tan Triple Ceramic	1LB	\$ 11.50	\$ 0.14
	D8132-312	MP812312	#10 x 3-1/2	Tan Triple Ceramic	1LB	\$ 12.00	\$ 0.20
	D8133-114	MP813114	#9 x 1-1/4	Tan Triple Ceramic	5LB	\$ 41.30	\$ 0.03
	D8133-158	MP813158	#9 x 1-5/8	Tan Triple Ceramic	5LB	\$ 41.00	\$ 0.04
	D8133-200	MP813200	#9 x 2	Tan Triple Ceramic	5LB	\$ 40.40	\$ 0.06
	D8133-212	MP813212	#9 x 2-1/2	Tan Triple Ceramic	5LB	\$ 41.00	\$ 0.08
	D8133-300	MP813300	#9 x 3	Tan Triple Ceramic	5LB	\$ 41.00	\$ 0.10
	D8133-318	MP813318	#10 x 3-1/8	Tan Triple Ceramic	5LB	\$ 42.40	\$ 0.13
	D8133-312	MP813312	#10 x 3-1/2	Tan Triple Ceramic	5LB	\$ 42.80	\$ 0.14
	D8133-400	MP813400	#10 x 4	Tan Triple Ceramic	5LB	\$ 42.50	\$ 0.16
	D8133-500	MP813500	#10 x 5	Tan Triple Ceramic	5LB	\$ 48.30	\$ 0.22
	D8133-600	MP813600	#12 x 6	Tan Triple Ceramic	5LB	\$ 49.70	\$ 0.41
	D8133-700	MP813700	#12 x 7	Tan Triple Ceramic	5LB	\$ 65.90	\$ 0.63
	D8133-800	MP813800	#12 x 8	Tan Triple Ceramic	5LB	\$ 70.20	\$ 0.74
	D8133-1000	MP8131000	#12 x 10	Tan Triple Ceramic	5LB	\$ 85.90	\$ 1.15
	D8133-1200	MP8131200	#12 x 12	Tan Triple Ceramic	5LB	\$ 96.50	\$ 1.48
	D8134-114	MP814114	#9 x 1-1/4	Tan Triple Ceramic	1/4 Keg	\$ 170.20	\$ 0.03
	D8134-158	MP814158	#9 x 1-5/8	Tan Triple Ceramic	1/4 Keg	\$ 182.40	\$ 0.04
	D8134-200	MP814200	#9 x 2	Tan Triple Ceramic	1/4 Keg	\$ 194.00	\$ 0.06
	D8134-212	MP814212	#9 x 2-1/2	Tan Triple Ceramic	1/4 Keg	\$ 172.00	\$ 0.07
	D8134-300	MP814300	#9 x 3	Tan Triple Ceramic	1/4 Keg	\$ 164.50	\$ 0.08
	D8134-318	MP814318	#10 x 3-1/8	Tan Triple Ceramic	1/4 Keg	\$ 178.10	\$ 0.11
	D8134-312	MP814312	#10 x 3-1/2	Tan Triple Ceramic	1/4 Keg	\$ 182.70	\$ 0.12
	D8134-400	MP814400	#10 x 4	Tan Triple Ceramic	1/4 Keg	\$ 144.70	\$ 0.14
	D8134-500	MP814500	#10 x 5	Tan Triple Ceramic	1/4 Keg	\$ 175.00	\$ 0.21
	D8134-600	MP814600	#12 x 6	Tan Triple Ceramic	1/4 Keg	\$ 181.20	\$ 0.36
	D8134-700	MP814700	#12 x 7	Tan Triple Ceramic	1/4 Keg	\$ 229.70	\$ 0.57
	D8134-800	MP814800	#12 x 8	Tan Triple Ceramic	1/4 Keg	\$ 204.80	\$ 0.68
	D8134-1000	MP8141000	#12 x 10	Tan Triple Ceramic	1/4 Keg	\$ 296.80	\$ 0.99
	D8134-1200	MP8141200	#12 x 12	Tan Triple Ceramic	1/4 Keg	\$ 384.90	\$ 1.28

*MSRP - Manufacturer's Suggested Retail Price is used to benchmark K9 Fasteners' value against competitive products.
For more products, continue on next page



Huskie, Greyhound, Bits & Nut Setter Items

Company Name: _____ Fax: _____
 Shipping Address: _____ Order Date: _____
 Email Address: _____ PO Number: _____

Qty.	K9 Item #	Vendor #	Screw/Bit Size	Color	Pack Size	MSRP*	MSRP*/Ea.
	H8233-114	MP822114	5/16 x 1-1/4	Tan Triple Ceramic	5LB	\$ 44.90	\$ 0.15
	H8233-212	MP822212	5/16 x 2-1/2	Tan Triple Ceramic	5LB	\$ 42.40	\$ 0.24
	H8233-300	MP822300	5/16 x 3	Tan Triple Ceramic	5LB	\$ 42.40	\$ 0.28
	H8233-312	MP822312	5/16 x 3-1/2	Tan Triple Ceramic	5LB	\$ 42.40	\$ 0.30
	H8233-400	MP822400	5/16 x 4	Tan Triple Ceramic	5LB	\$ 42.40	\$ 0.34
	H8233-500	MP822500	5/16 x 5	Tan Triple Ceramic	5LB	\$ 47.70	\$ 0.48
	H8233-600	MP822600	5/16 x 6	Tan Triple Ceramic	5LB	\$ 52.20	\$ 0.58
	H8233-800	MP822800	3/8 x 8	Tan Triple Ceramic	5LB	\$ 73.20	\$ 1.33
	H8233-1000	MP8221000	3/8 x 10	Tan Triple Ceramic	5LB	\$ 95.80	\$ 2.13
	H8233-1200	MP8221200	3/8 x 12	Tan Triple Ceramic	5LB	\$ 105.80	\$ 2.78
	H8234-300	MP823300	5/16 x 3	Tan Triple Ceramic	1/4 Keg	\$ 143.90	\$ 0.24
	H8234-312	MP823312	5/16 x 3-1/2	Tan Triple Ceramic	1/4 Keg	\$ 141.50	\$ 0.28
	H8234-400	MP823400	5/16 x 4	Tan Triple Ceramic	1/4 Keg	\$ 125.70	\$ 0.31
	H8234-500	MP823500	5/16 x 5	Tan Triple Ceramic	1/4 Keg	\$ 150.80	\$ 0.43
	H8234-600	MP823600	5/16 x 6	Tan Triple Ceramic	1/4 Keg	\$ 171.40	\$ 0.57
	H8234-800	MP823800	3/8 x 8	Tan Triple Ceramic	1/4 Keg	\$ 254.40	\$ 1.27
	H8234-1000	MP8231000	3/8 x 10	Tan Triple Ceramic	1/4 Keg	\$ 288.20	\$ 1.60
	H8234-1200	MP8231200	3/8 x 12	Tan Triple Ceramic	1/4 Keg	\$ 302.50	\$ 2.02
	G8011-158	MP827158	#8 x 1-5/8	Yellow Zinc	100 ct	\$ 11.80	\$ 0.06
	G8011-200	MP827200	#8 x 2	Yellow Zinc	100 ct	\$ 11.80	\$ 0.07
	G8011-212	MP827212	#8 x 2-1/2	Yellow Zinc	100 ct	\$ 12.00	\$ 0.09
	G8011-300	MP827300	#8 x 3	Yellow Zinc	100 ct	\$ 12.40	\$ 0.12
	G8021-158	MP830158	#8 x 1-5/8	White Triple Ceramic	100 ct	\$ 44.50	\$ 0.04
	G8021-200	MP830200	#8 x 2	White Triple Ceramic	100 ct	\$ 44.50	\$ 0.05
	G8021-212	MP830212	#8 x 2-1/2	White Triple Ceramic	100 ct	\$ 44.50	\$ 0.07
	G8021-300	MP830300	#8 x 3	White Triple Ceramic	100 ct	\$ 47.60	\$ 0.09
	G8031-158	MP833158	#8 x 1-5/8	Tan Triple Ceramic	100 ct	\$ 13.20	\$ 0.07
	G8031-200	MP833200	#8 x 2	Tan Triple Ceramic	100 ct	\$ 13.20	\$ 0.08
	G8031-212	MP833212	#8 x 2-1/2	Tan Triple Ceramic	100 ct	\$ 13.40	\$ 0.10
	G8031-300	MP833300	#8 x 3	Tan Triple Ceramic	100 ct	\$ 13.80	\$ 0.13
	G8033-158	MP834158	#8 x 1-5/8	Tan Triple Ceramic	5LB	\$ 11.40	\$ 0.06
	G8033-200	MP834200	#8 x 2	Tan Triple Ceramic	5LB	\$ 11.40	\$ 0.07
	G8033-212	MP834212	#8 x 2-1/2	Tan Triple Ceramic	5LB	\$ 11.60	\$ 0.09
	G8033-300	MP834300	#8 x 3	Tan Triple Ceramic	5LB	\$ 12.10	\$ 0.12
	B2011-10	MP20010	T10 1" Power Bit	T10 Purple	10/pack	\$ 7.50	\$ 0.75
	B2011-15	MP20015	T15 1" Power Bit	T15 Blue	10/pack	\$ 7.50	\$ 0.75
	B2011-20	MP20020	T20 1" Power Bit	T20 Green	10/pack	\$ 7.50	\$ 0.75
	B2011-25	MP20025	T25 1" Power Bit	T25 Yellow	10/pack	\$ 7.50	\$ 0.75
	B2011-30	MP20030	T30 1" Power Bit	T30 Orange	10/pack	\$ 7.50	\$ 0.75
	B2011-40	MP20040	T40 1" Power Bit	T40 Red	10/pack	\$ 7.50	\$ 0.75
	B2021-10	MP20110	T10 2" Power Bit	T10 Purple	10/pack	\$ 13.90	\$ 1.39
	B2021-15	MP20115	T15 2" Power Bit	T15 Blue	10/pack	\$ 13.90	\$ 1.39
	B2021-20	MP20120	T20 2" Power Bit	T20 Green	10/pack	\$ 13.90	\$ 1.39
	B2021-25	MP20125	T25 2" Power Bit	T25 Yellow	10/pack	\$ 13.90	\$ 1.39
	B2021-30	MP20130	T30 2" Power Bit	T30 Orange	10/pack	\$ 13.90	\$ 1.39
	B2021-40	MP20140	T40 2" Power Bit	T40 Red	10/pack	\$ 13.90	\$ 1.39
	N3001-14	MP20601	1/4"	1/4" Blue	10/pack	\$ 38.30	\$ 3.83
	N3001-516	MP20602	5/16"	5/16" Yellow	10/pack	\$ 42.90	\$ 4.29
	N3001-38	MP20603	3/8"	3/8" Orange	10/pack	\$ 46.10	\$ 4.61
	N3001-716	MP20604	7/16"	7/16" Red	10/pack	\$ 56.90	\$ 5.69



ORDERING FROM K9 Fasteners

- Prices are subject to change without notice. For up-to-date pricing, visit www.k9fasteners.com.
- To ensure 100% accuracy orders are preferred via fax, e-mail, or online at www.k9fasteners.com.
- Shipping charges appear on your sales order confirmation.

ORDERING TERMS

- Approved credit application, sales tax #, W9 and references are required to establish a new account.
- Invoice terms are NET 30 days, aged from invoice date. Past-due accounts are charged 1½% per month on past-due amounts. Orders from past-due accounts are put on hold.

SHIPPING TERMS

- Shipments are prepaid at \$700 NET for orders shipped within the continental United States.
- Orders less than \$700 will have ground shipping charges added to the invoice.
- Delivery charges for orders shipped to Alaska and Hawaii will be quoted prior to shipment.
- K9 Fasteners will select the carrier for all shipments.
- A \$10 drop-ship fee will be added to all orders shipped directly to a residence or a retailers customer.

PICKUPS

- We do not have counter service

RETURNS/CREDITS/SHIPPING ERRORS

- A Return Merchandise Authorization (RMA) is required for all returns.
- Customers have 30 days to request a RMA from our customer service department.
- Product must be returned within 10 days after receipt of the RMA.
- Returns for any reason other than manufacturer defect or K9 Fasteners error are subject to a 15% restocking fee.
- In all instances, the product must be returned in saleable condition, in the original packaging and inside an outer carton. Any return with price stickers, label damage or other package damage will be rejected.
- All claims for shortage and/or damaged goods must be reported within five days from receipt of merchandise.

Business Hours 8:00 AM to 5:00 PM Central Time

PLEASE BE ADVISED

- Possession of this catalog does not constitute permission to purchase or an obligation to sell.
- Product prices are subject to change without notice.
- Prepaid shipping minimum subject to change.





HAPPY ANNIVERSARY

2019 marked 10 years of success for K9 fasteners. We have hundreds of retailers and thousands of builders that choose the loyalty, value and performance of our fasteners every single day. Experience for yourself how Doberman, Huskie and Greyhound products are Faster, Stronger, and Safer!

Hours & Location:

8:00 AM to 5:00 PM Central Time

PO Box 2673
Appleton, WI 54912

Tel: 888.205.2355
Fax: 888.839.5997

VISIT US AT:
www.k9fasteners.com

©1039 K9 Fasteners

"K9 Fasteners have really caught on over the past 6 years. Our customers love them because they are the best value compared to the over-priced competition."

*- R.C. Goodwyn & Sons
Powhatan, VA*

"There are many reasons to choose K9 Fasteners but the fast starts, ceramic coating and product strength have made both Doberman deck screws and Huskie lags a winner for us for many years."

*- Beaver Builders Supply Inc.
Holmen, WI*

"I have NEVER-EVER had a performance problem in the 9 years I have sold K9. This product is a GREAT value for me and my customers."

*- Hennen Lumber Company
Freeport, MN*

"K9 fasteners are the real deal. They don't snap off like other brands when put to the true test in the field, they're faster, and less expensive than the competition"

*- Ethan Coop Lumber
Ethan, SD*

"For us, the K9 fastener is a high performance product at a good price point. We like the 1# & 5 # packaging for merchandising and display. The K9 fastener program has been a good fit for the How To Building Center."

*- Farmers Co-op Society
Sioux Center, IA*

"Good quality product at the best price. We have not found anything better than K9 anywhere else."

*- Pioneer General Store
Mio MI*

JOIN THE PACK!