

LL-WL271

ASSEMBLY STEPS:

1. REMOVE ALL BRACKET FROM THE LAMP FIXTURE AND ATTACH THE MOUNTING CROSS BAR [C] ONTO THE WALL BRACKET ON THE WALL AND FASTENING WITH THE MOUNTING SCREWS[E] (2PCS)
2. CONNECT THE BLACK CORD OF LAMP WITH THE ANODE WIRE ON WALL BRACKET BY CONNECTOR[A], CONNECT WHITE CORD OF LAMP WITH CATHODE WIRE ON WALL BRACKET BY CONNECTOR [A]. CONNECT THE GROUND WIRE TO THE WALL GROUND WIRE BY CONNECTOR[B].
3. TIGHTEN THE BACKPLATE [F] ON THE MOUNTING CROSS BAR [C] BY SCREW NUTS [H].
4. PUT THE SHADE[K] ONTO THE SOCKET CAP[J] AND TIGHTEN BY SCREWS [I].

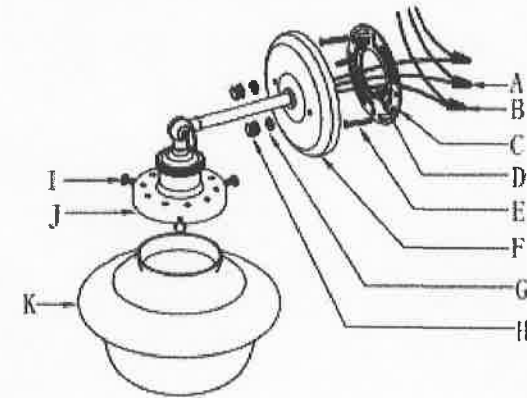

CAUTION: PULL ANY EXCESS WIRE THROUGH BOTTOM OF THE LAMP.
TO CLEAN, USE A SOFT CLOTH ONLY.

NOTE: TURN THE POWER OFF (UNPLUG FROM THE WALL OUTLET) BEFORE REPLACING THE BULB. MAKE SURE THE BULB HAS SUFFICIENT TIME TO COOL DOWN. DO NOT SUBJECT THE LAMP TO ANY SHOCK WHILE LIT AS SHATTERING OF LAMP MAY RESULT.