

## INSTALLATION INSTRUCTION FOR PENDANT LAMP

### SAFETY PRECAUTIONS:

1. TURN OFF ELECTRICAL POWER BEFORE STARTING INSTALLATION OF LIGHT FIXTURE.  
DO NOT REMOVE INSULATION FROM FIXTURE.
2. THIS PRODUCT MUST BE INSTALLED IN ACCORDANCE WITH THE APPLICABLE INSTALLATION CODE BY A PERSON FAMILIAR WITH THE CONSTRUCTION AND OPERATION OF THE PRODUCT AND THE HAZARDS INVOLVED.
3. CONNECT THE GROUND WIRE (BARE COPPER OR GREEN) FROM YOUR FIXTURE TO THE GROUND WIRE (BARE COPPER OR GREEN) OR GROUND SCREW IN THE ELECTRICAL OUTLET BOX.

### INSTALLATION:

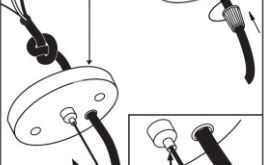
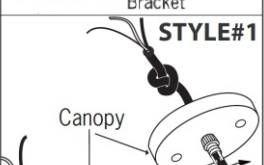
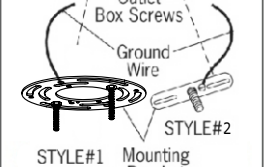
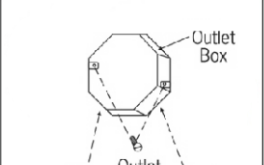
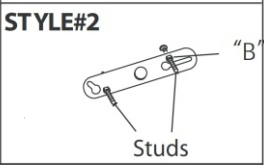
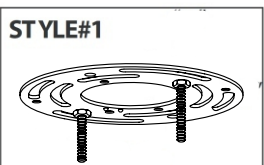

1. Refer to the mounting bracket style that matches the bracket that is included with your fixture.

Style#1 -Loosen hex nut "A" and "B". Adjust stud so it clears the fixture once assembled. Hold in place with "A" and lock in place with "B".

Style#2 (Threaded holes) Loosen "B". Adjust stud to desired length and lock in place with "B".

2. Attach the mounting bracket to outlet box using outlet box screws. (not included).

3. Adjusting the length of flexible cord. For safety, do not release the knot inside canopy.

STYLE #1- Loosen the plastic screw for adjusting the length of flexible cord. Re-tighten plastic screw after adjusting.

STYLE #2- Adjust the height of the fixture by pushing the button. Ensure the cord does not touch the light bulb(s) when adjusting the height of the fixture or the steel cable(s).

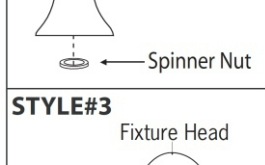
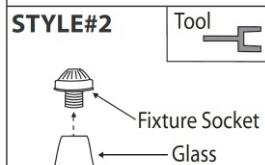
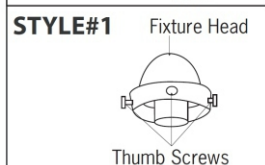
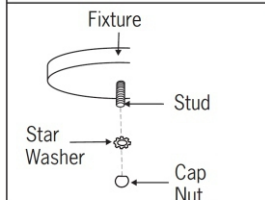
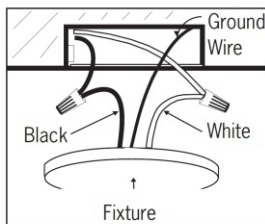

4. Connect the ground wire (bare copper or green) from your fixture to the ground wire (bare copper or green) or ground screw in the electrical outlet box. Connect the black wire (or wire with marketing) from the fixture to the black wire in the electrical box and connect the white wire from the fixture to the white wire in the electrical box.

5. Tuck electrical wires into outlet box and position fixture over studs or nipple on mounting bracket assembly. Secure fixture in place with star washer(s) and cap nut(s).

6. Mounting Glass To Fixture  
NOTE: Refer to the style of assembly that matches the style of your fixture.

**STYLE #1**-Using thumb screws provided, attach the glass to the fixture head. Place the glass into the fixture head and tighten screws into the groove or holes in the glass.

**STYLE #2**-Remove spinner nut from socket. Position glass on lamp and secure with spinner nut. On some fixtures, a tool is included to attach the spinner nut.

**STYLE #3**-Squeeze the two clips together around the socket. Slide the glass over the clips, then push the glass up snug to the fixture head.

7. If not already done, install proper bulb type and wattage (not included).

## INSTALLATION

1. CAREFULLY PULL CORD [B] THROUGH HOLE IN UPPER BOX AND ADJUST THE CORD LENGTH.
2. CONNECT THE FIXTURE [A] TO THE UPPER BOX BY HOOKING EACH FIXTURE ARM [D1], [D2], [D3] INTO CORRESPONDING EYELETS [C].
3. SCREW THE RODS [E] AND CANOPY [G] TO THE SCREW [F] ON UPPER BOX.
4. ATTACH THE CIRCLE CROSS BAR TO THE OUTLET BOX USING OUTLET BOX SCREWS.
5. PLACE THE CANOPY [G] ONTO THE CIRCLE CROSS BAR, THEN SCREW WITH FINIAL [H].
6. INSTALL BULBS. (BULB INCLUDED)

LL-CH5-26-5BLK / LL-CH5-38-5BLK / LL-CH5-50-5BLK / LL-CH5-1836-5BLK

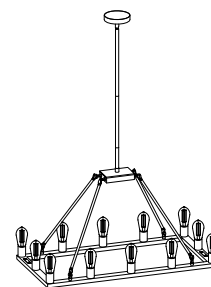

LL-CH5-1836-5BLK

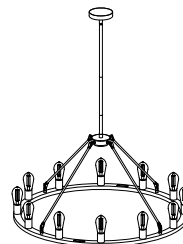

LL-CH5-38-5BLK

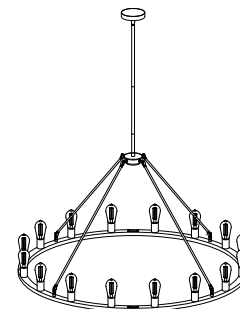

LL-CH5-50-5BLK

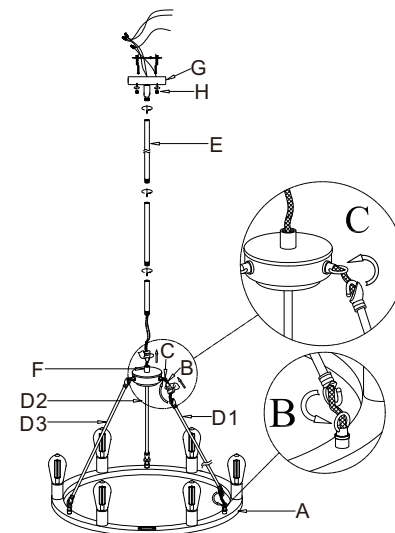

LL-CH5-26-5BLK

**CAUTION:** PULL ANY EXCESS WIRE THROUGH BOTTOM OF THE LAMP. PLEASE USE TYPE ST19 LED BULB. DO NOT USE LIGHT BULB RATED GREATER THAN 4 WATTS OR THE LAMP MAY BURN AND CAUSE A FIRE! TO CLEAN, USE A SOFT CLOTH ONLY.

**NOTE:** TURN THE POWER OFF (UNPLUG FROM THE WALL OUTLET) BEFORE REPLACING THE BULB. MAKE SURE THE BULB HAS SUFFICIENT TIME TO COOL DOWN. DO NOT SUBJECT THE LAMP TO ANY SHOCK WHILE LIT AS SHATTERING OF LAMP MAY RESULT.